

# Evaluation of Concrete Pavement Buckling in Wisconsin

---

Shreenath Rao, Ph.D., P.E.  
Hesham Abdulla, Ph.D.  
Hyung Lee, Ph.D., P.E.  
Michael Darter, Ph.D., P.E.

Applied Research Associates, Inc.

WisDOT ID No. 0092-20-02

February 2022



RESEARCH & LIBRARY UNIT



WISCONSIN HIGHWAY RESEARCH PROGRAM

**WISCONSIN DOT**  
PUTTING RESEARCH TO WORK

REPORT DOCUMENTATION PAGE

1. Report No. <b>0092-20-02</b>		2. Government Accession No.		3. Recipient's Catalog No.	
4. Title and Subtitle <b>Evaluation of Concrete Pavement Buckling in Wisconsin</b>			5. Report Date <b>February 2022</b>		
			6. Performing Organization Code		
7. Author(s) <b>Shreenath Rao, Ph.D., P.E., Hesham Abdulla, Ph.D., Hyung Lee, Ph.D., P.E., Michael Darter, Ph.D., P.E.</b>			8. Performing Organization Report No.		
9. Performing Organization Name and Address <b>Applied Research Associates, Inc., 100 Trade Centre Dr., Champaign, IL 61820</b>			10. Work Unit No.		
			11. Contract or Grant No. <b>WHRP 0092-20-02</b>		
12. Sponsoring Agency Name and Address <b>Wisconsin Department of Transportation Research &amp; Library Unit 4822 Madison Yards Way Madison, WI 53705</b>			13. Type of Report and Period Covered <b>Final Report October 2019 to February 2022</b>		
			14. Sponsoring Agency Code		
15. Supplementary Notes <b>Final Report</b>					
16. Abstract <b>Buckling of concrete pavements is a serious problem in many states, but even more so in Wisconsin due to a combination of factors including climate, construction practices, maintenance practices, materials, and design. Although the incidences of buckling in concrete are fewer than other distresses such as cracking and spalling, they disproportionately affect the traveling public due to potential safety concerns requiring immediate repair, which is expensive and can be difficult. The research team investigated buckling in Wisconsin by conducting a thorough literature review, interviewing agency and industry representatives from other states and countries, reviewing neighboring agency standards and specifications, performing field investigations of eight buckling sites and three control sites in Wisconsin, analyzing the field data, and simulating the risk of buckling using analytical modeling. Based on the research activities, the research team noted factors that increase the risk of buckling and provided recommendations to reduce the occurrences of buckling in Wisconsin. Specific recommendations include considering single cut sawed joints filled with low modulus sealant to reduce amount of incompressibles and water infiltrating through the joints, reviewing and making changes to cold weather concreting practices to reduce likelihood of low neutral temperature thus effectively increasing the concrete temperature at which buckling happens, specifying strong and more durable concrete to increase concrete's resistance to compressive stresses, using concrete with lower coefficient of thermal expansion when possible to reduce expansion and associated compressive stresses, repairing spalled joints with concrete full- or partial depth patches as soon as practical to improve joint integrity, providing positive drainage in areas susceptible to moisture to reduce concrete damage, using a stabilized base course to increase friction and reduce compressive stresses, and using wider paved shoulders and vegetation beyond shoulders to help reduce the availability of incompressibles to the mainline joint and crack. Wisconsin Department of Transportation should also experiment with forcing joints to activate to reduce the number of dominant joints and consider using pressure relief expansion joints as a last resort when other options have been exhausted.</b>					
17. Key Words <b>buckling, blowups, blowouts, concrete pavement distress, joint incompressibles, temperature effects, concrete thermal expansion, concrete joints, spalling</b>			18. Distribution Statement <b>No restrictions. This document is available through the National Technical Information Service. 5285 Port Royal Road Springfield, VA 22161</b>		
19. Security Classif. (of this report) <b>Unclassified</b>		20. Security Classif. (of this page) <b>Unclassified</b>		21. No. of Pages <b>152</b>	22. Price

## **Disclaimer**

This research was funded through the Wisconsin Highway Research Program by the Wisconsin Department of Transportation and the Federal Highway Administration under Project 0092-20-02. The contents of this report reflect the views of the authors who are responsible for the facts and accuracy of the data presented herein. The contents do not necessarily reflect the official views of the Wisconsin Department of Transportation or the Federal Highway Administration at the time of publication.

This document is disseminated under the sponsorship of the Department of Transportation in the interest of information exchange. The United States Government assumes no liability for its contents or use thereof. This report does not constitute a standard, specification, or regulation.

The United States Government does not endorse products or manufacturers. Trade and manufacturers' names appear in this report only because they are considered essential to the object of the document.

## Table of Contents

<b>Disclaimer .....</b>	<b>iii</b>
<b>Table of Contents .....</b>	<b>iv</b>
<b>List of Figures.....</b>	<b>vii</b>
<b>List of Tables .....</b>	<b>x</b>
<b>Executive Summary .....</b>	<b>1</b>
<b>Introduction.....</b>	<b>3</b>
<b>Mechanisms of Buckling.....</b>	<b>5</b>
<b>Kerr and Shade (1984), Kerr and Dallas (1985) .....</b>	<b>5</b>
<b>Stott and Brook 1968, McBride and Decker 1975 .....</b>	<b>6</b>
<b>Burke (1987) .....</b>	<b>8</b>
<b>Shober and Rutkowski (1996) and Shober (1997) .....</b>	<b>10</b>
<b>Factors Impacting Buckling.....</b>	<b>11</b>
<b>Other Agencies Experiences with Buckling.....</b>	<b>15</b>
<b>Field Investigation.....</b>	<b>20</b>
<b>Site Selection.....</b>	<b>22</b>
<b>Description of Field Survey.....</b>	<b>23</b>
<b>Results and Discussions of Field Survey .....</b>	<b>26</b>
<b>Transverse Joint Spalling and Asphalt Patching.....</b>	<b>26</b>
<b>Cores .....</b>	<b>30</b>
<b>Incompressibles.....</b>	<b>34</b>
<b>Vertical Elevation and Grade of Buckling Sites .....</b>	<b>39</b>
<b>Coefficient of Thermal Expansion (CTE).....</b>	<b>42</b>
<b>Subsurface Drainage.....</b>	<b>43</b>
<b>Dowel Alignment.....</b>	<b>44</b>
<b>Data Analysis.....</b>	<b>45</b>
<b>Analytical Model .....</b>	<b>49</b>
<b>Effect of Temperature .....</b>	<b>49</b>
<b>Equivalent Temperature due to Moisture and Humidity .....</b>	<b>52</b>
<b>Application to Field Data .....</b>	<b>54</b>
<b>Sensitivity Analysis .....</b>	<b>61</b>
<b>Conclusions.....</b>	<b>64</b>
<b>Recommendations.....</b>	<b>75</b>
<b>Appendix A: Risk Factors for Buckling .....</b>	<b>80</b>

Climate (Temperature and Moisture).....	80
Coefficient of Thermal Expansion.....	80
Strength and Durability .....	81
Foundation.....	83
Age since Construction .....	84
Shoulder .....	84
Joint Spacing .....	85
Slab Neutral (Approximately Set) Temperature .....	86
Weather.....	87
Dowels .....	88
Asphalt Overlay .....	88
<b>Appendix B: Incompressibles in Transverse Joints as a Risk Factor for Buckling.....</b>	<b>89</b>
Utah Experience .....	91
Nebraska Experience .....	93
<b>Appendix C: Joint/Crack Spalling as a Risk Factor for Buckling .....</b>	<b>95</b>
<b>Appendix D: Literature Review – Other Agencies Experiences with Buckling.....</b>	<b>97</b>
Illinois.....	97
Indiana .....	97
Ohio, Michigan, New York, Wisconsin (All old long JRCP) .....	99
<b>Appendix E: Research Team Interviews – Other Agencies Experiences with Buckling ...</b>	<b>100</b>
Minnesota .....	100
Arizona (Scott Weiland, Arizona DOT) .....	100
Iowa (Chris Brakke, Iowa DOT; Gordon Smith, National Concrete Pavement Technology Center at Iowa State University) .....	100
Illinois.....	101
Illinois Tollway .....	101
Utah (David Holmgren, Utah DOT; Pat Nolan, Portland Cement Association) .....	102
California.....	103
Washington/Oregon.....	104
Georgia.....	104
Colorado (Angela Folkestad, American Concrete Pavement Association – Colorado/Wyoming Chapter) .....	104
Europe (Luc Rens, EUROPAVE).....	104
<b>Appendix F: Neighboring Agency Practices and Designs.....</b>	<b>109</b>
Iowa .....	109

<b>Joint Design</b> .....	109
<b>Maintenance and Rehabilitation Treatments</b> .....	113
<b>Subsurface Drainage</b> .....	115
<b>Cold Weather Concreting</b> .....	116
<b>Illinois</b> .....	117
<b>Joint Design</b> .....	117
<b>Maintenance and Rehabilitation Treatments</b> .....	119
<b>Subsurface Drainage</b> .....	121
<b>Cold Weather Concreting</b> .....	122
<b>Minnesota</b> .....	122
<b>Joint Design</b> .....	122
<b>Maintenance and Rehabilitation Treatments</b> .....	127
<b>Subsurface Drainage</b> .....	128
<b>Cold Weather Concreting</b> .....	129
<b>Michigan</b> .....	130
<b>Joint Design</b> .....	130
<b>Maintenance and Rehabilitation Treatments</b> .....	133
<b>Subsurface Drainage</b> .....	134
<b>Cold Weather Concreting</b> .....	135
<b>Indiana</b> .....	136
<b>Joint Design</b> .....	136
<b>Maintenance and Rehabilitation Treatments</b> .....	138
<b>Subsurface Drainage</b> .....	139
<b>Cold Weather Concreting</b> .....	139
<b>Joint Design</b> .....	140
<b>Maintenance and Rehabilitation Treatments</b> .....	144
<b>Subsurface Drainage</b> .....	144
<b>Cold Weather Concreting</b> .....	145
<b>References</b> .....	147

## List of Figures

Figure 1. Blowup on Hwy 14 in Rock county (Courtesy: Rock County Sheriff’s Office).....	3
Figure 2. Recently buckled joint on I-39 SB in Columbia county, WI. ....	4
Figure 3. Axial forces in a rigid pavement (a) before and (b) after buckling (Kerr and Shade 1984) .....	6
Figure 4. Mechanism of pavement buckling (adapted from McBride and Decker 1975). ....	7
Figure 5. Cyclic movement at construction joints (Burke 1987).....	9
Figure 6. Hypothesized stress or pressure generation curves for jointed pavement (Burke 1998). 9	
Figure 7. Number of blowups in Wisconsin between 2013 and 2021.....	21
Figure 8. Geographic distribution of blowups in Wisconsin between 2013 and 2019. ....	21
Figure 9. Geographical locations of selected buckling and control sites.....	23
Figure 10. Each joint was divided into two equal segments for visual evaluation of incompressibles.....	24
Figure 11. Number of transverse joint spalls (width of spall $\geq$ 1.0 inch) and asphalt patches over a 1,000-ft section for buckling and control sites. ....	26
Figure 12. Transverse joints showing the outer transverse joint sections with spalling at various levels of severity at different buckling sites. ....	27
Figure 13. Google Earth® images of U.S. 10 in Portage county (site # 1) prior to buckling showing spalls, shoulder cracking, and asphalt patching (left and bottom). Image on the right, collected during the September 2020 field survey shows the same location patched with full-depth asphalt following the blowup. ....	28
Figure 14. October 2017 Google Earth® images of U.S. 12 prior to buckling showing spalls and asphalt patching (top). July 2018 Google Earth® image of the same joint following buckling (bottom).....	29
Figure 15. Cores from buckling sites taken from transverse joints and core holes showing spalls in the lower portion of the joint. ....	31
Figure 16. Cores from control sites taken from transverse joints and core holes showing no spalls in the lower portion of the joint. ....	33
Figure 17. Delamination cracking beneath the surface of the concrete near Site # 4 on I-39. ....	34
Figure 18. Incompressible rating index for buckling and control sites.....	35
Figure 19. Comparison of individual joint incompressible rating indices between nearby control (left) and buckling (right) sites. ....	36
Figure 20. One source of incompressibles showing small rocks, sands, and fines near buckling location.....	38
Figure 21. Another source of incompressibles showing small aggregate popped out from concrete surface and transverse tines (site # 4).....	38
Figure 22. Photo of incompressibles in the transverse joint. ....	39
Figure 23. Number of vertical elevation locations representing 74 buckling locations. ....	40
Figure 24. Edge drainage showing no clogging.....	44
Figure 25. Joint scores of buckling sites.....	44
Figure 26. Joint scores of control sites.....	45
Figure 27. Number of spalls and asphalt patches vs. incompressibles rating index. ....	47
Figure 28. Number of blowups per mile vs. incompressibles rating index. ....	47
Figure 29. Number of blowups per mile vs. number of spalls and asphalt patches.....	48
Figure 30. Friction at PCC slab and base interface.....	49

Figure 31. Equivalent temperature increase needed for buckling with (a) 0 percent, (b) 50 percent, and (c) 100 percent incompressible materials within the joint (granular base).	51
Figure 32. Distribution of shrinkage multiplier.	54
Figure 33. Control site # 1 (a) temperature, (b) relative humidity, and (c) mean $\Delta T_{Total}$ .	55
Figure 34. Probability of buckling for control site #1 for neutral temperatures of (a) 50 °F, (b) 70 °F, and (c) 90 °F.	56
Figure 35. Expected number of buckled joints for control site #1 for neutral temperatures of (a) 50 °F, (b) 70 °F, and (c) 90 °F.	57
Figure 36. Buckling site #7 (a) temperature, (b) relative humidity, and (c) mean $\Delta T_{Total}$ .	58
Figure 37. Probability of buckling for site # 7 for neutral temperatures of (a) 50 °F, (b) 70 °F, and (c) 90 °F.	59
Figure 38. Expected Number of Buckled Joints for Site # 7 for Neutral Temperatures of (a) 50 °F, (b) 70 °F, and (c) 90 °F.	60
Figure 39. Sensitivity of Buckling Temperature to Various Inputs (GB).	63
Figure 40. Sensitivity of Buckling Temperature to Various Inputs (CTB).	63
Figure 41. Utah repair, deterioration, and buckling sequence (McBride and Decker 1975).	91
Figure 42. Core showing 3 layers of contamination.	93
Figure 43. Spalling along the shoulder joint where incompressibles infiltrated after only 1.5-years of service on I-80 in Nebraska (left). Core taken in the spall area (right).	94
Figure 44. Illustration showing how variations in concrete facing along a transverse joint or crack can result in variation of compressive stresses and higher risk for buckling (Rens 2018).	96
Figure 45. Buckling caused by HMA patching (Rens 2018).	107
Figure 46. Buckling caused by poor joint sealing (Rens 2018).	108
Figure 47. Transverse contraction joint design layout (Iowa DOT 2020).	111
Figure 48. Longitudinal contraction joint design layout (Iowa DOT 2020).	112
Figure 49. Partial depth PCC finish patches Iowa DOT standard (Iowa DOT 2020).	114
Figure 50. Full depth PCC patches with dowels Iowa DOT standard (Iowa DOT 2020).	115
Figure 51. Transverse contraction joint Illinois DOT standard (Illinois DOT 2021).	117
Figure 52. Longitudinal sawed joints Illinois DOT standard (Illinois DOT 2021).	118
Figure 53. Typical rigid pavement design with tied shoulder (Illinois DOT 2021).	118
Figure 54. Contraction joints (Minnesota DOT 2019).	125
Figure 55. Longitudinal joints (Minnesota DOT 2019).	126
Figure 56. Network level concrete decision tree (Minnesota DOT 2018).	128
Figure 57. Typical subsurface drainage section (Minnesota DOT 2007).	129
Figure 58. Longitudinal pavement joints (Michigan DOT 2020a).	131
Figure 59. Transverse construction joints (Michigan DOT 2020a).	132
Figure 60. Transverse expansion joints (Michigan DOT 2020a).	133
Figure 61. Typical subsurface drain system (Michigan DOT 2019).	135
Figure 62. Type D-1 contraction joint (Indiana DOT 2021).	137
Figure 63. Longitudinal contraction and construction joint (Indiana DOT 2021).	137
Figure 64. Transverse construction joint (Indiana DOT 2021).	138
Figure 65. Deteriorated Joints on Highway 417 (Chan et al. 2020).	141
Figure 66. Deterioration below the surface of a visibly intact joint on Hwy 417 (Chan et al. 2020).	141



Figure 67. New (left) and old (right) joint design schematics (MTO 2018)..... 142  
Figure 68. New joint design filled with a low-modulus joint sealant (MTO 2018). ..... 143  
Figure 69. Core at the joint filled with sealant (MTO 2018). ..... 143  
Figure 70. Typical cross-section of subsurface drainage system (MTO 2013). ..... 145

## List of Tables

Table 1. Neighboring agency practices relevant summary. ....	16
Table 2. Buckling sites for field forensic investigation. ....	22
Table 3. Template of incompressible materials survey. ....	24
Table 4. Vertical elevation of buckling locations. ....	41
Table 5. Coefficient of thermal expansion of concrete mixtures made with different coarse aggregates (Naik et al. 2011). ....	43
Table 6. Field data collected from buckling and control sites. ....	45
Table 7. Correlation coefficient between variables. ....	46
Table 8. Inputs for Monte-Carlo simulation of buckling. ....	51
Table 9. Types of materials-related distress (Van Dam et al. 2002a). ....	82
Table 10. Effect of shoulder type on blowups (Foxworthy 1973). ....	84
Table 11. Dowel bar size and length (SUDAS 2021). ....	113
Table 12. Maintenance and rehabilitation for concrete pavement (SUDAS 2021). ....	113
Table 13. Concrete pavement protection requirements (Iowa DOT 2015). ....	116
Table 14. Illinois DOT rigid pavement treatment selection decision matrix (Illinois DOT 2021). ....	121
Table 15. Concrete joint spacing and dowel bars (Minnesota DOT 2019). ....	124
Table 16. Concrete joint sealing guidelines (Minnesota DOT 2019). ....	124
Table 17. Contraction joint reference, detail, and sealant specification (Minnesota DOT 2019). ....	124
Table 18. Longitudinal joint reference, detail, and sealant specification. ....	126
Table 19. Trigger values by functional classification (Minnesota DOT 2018). ....	127
Table 20. Concrete pavement treatments and trigger vales (Michigan DOT 2020c). ....	134
Table 21. Concrete preventive maintenance treatments (Indiana DOT 2020). ....	138
Table 22. Decision matrix for rigid pavement (MTO 2013). ....	144

## Executive Summary

The number of blowups in Wisconsin has increased each year over the past decade. Most blowups occurred in jointed plain concrete pavement (JPCP) with a few that occurred in resurfaced concrete pavement and continuously reinforced concrete pavements (CRCP). Although the incidences of buckling are fewer than distresses such as cracking and spalling, they are more disruptive to the traveling public due to potential safety concerns and need for immediate repair.

The goal of this research study was to investigate buckling of concrete pavements, reveal the key mechanisms and factors that impact buckling, and identify methods to reduce the risk of buckling. The research was conducted by performing a thorough literature review, interviewing personnel from other highway agencies and industry representatives regarding their experiences with buckling in their jurisdiction, reviewing standards and specifications of six highway agencies neighboring Wisconsin, performing a field investigation of eight buckling sites and three control sites in Wisconsin, reviewing and analyzing the field data, and simulating the risk of buckling using analytical modeling.

The research indicated that buckling is a phenomenon that develops over time and has many potential contributing factors and mechanisms, each one posing some level of risk that buckling may develop on a specific project or even a specific joint or crack. These factors and mechanisms are explained and summarized in this document. The key driver of buckling is an increase in temperature and moisture of concrete slabs in summer months. However, the risk of buckling of an individual joint or crack under conditions of increased temperature and moisture, is influenced by a complex combination of construction factors such as weather conditions during concrete placement and any significant dowel misalignment; concrete mix design properties such as coefficient of thermal expansion (CTE), strength, durability characteristics, shrinkage characteristics; design factors such as concrete thickness, base type, joint sawing and filling or sealing, joint spacing, and shoulder type; and other factors such as incompressibles infiltrating the joint or crack, spalling, and patching of joint or crack.

Key factors contributing to higher incidences of buckling in Wisconsin relative to other midwestern states and northeastern states, and much higher incidences of buckling relative to southern and northwestern states include hot and humid summers with rainfall, concrete paving operations performed during cold winter months, leaving joints unfilled or unsealed throughout

the life of the pavement, using an unbound aggregate base course beneath the concrete slab, using salt, sand, and grit for winter maintenance activities, potential durability issues from using less durable concrete mixes in the past contributing to moisture damage and salt damage of the hardened concrete, and the use of asphalt patches for spall repairs.

Based on a review of mechanisms of buckling and factors that contribute to increased risk of buckling in Wisconsin, the research team provided the following recommendations to reduce the occurrences of buckling in Wisconsin:

- Use a single saw cut and fill transverse joints with a low modulus sealant,
- Review and update cold weather concreting practices with a goal towards reducing occurrences of placement of concrete during low ambient temperatures or on cold base courses,
- Specify strong and more durable concrete by optimizing concrete mixtures,
- Use concrete with lower CTE when possible,
- Repair spalled joints with concrete full- or partial depth patches as soon as practical,
- Provide positive drainage in areas susceptible to water,
- Use a stabilized base course,
- Use wider paved shoulders and vegetation beyond shoulders,
- Experiment with forcing joints to activate, and
- Use pressure relief expansion joints as a last resort.

In addition to the above recommendations, the following are some additional recommendations for CRCP. Require the repair of wide transverse cracks with a full lane width full-depth concrete as soon as possible and increase quality control and inspection of construction joints.

## Introduction

Buckling, also commonly termed blowup and sometimes blowout, in portland cement concrete (PCC) pavement is a localized upward movement, typically at or near joints or cracks, often resulting in shattering of the concrete slab. As the temperature or moisture in a series of consecutive slabs starts to increase, the slabs tend to expand in length (and volume). If the openings of the joint or crack between adjacent slabs (that develop following construction due to shrinkage of the concrete) is insufficient to accommodate this expansion, and the concrete strength at or near the joint or crack is insufficient to accommodate the buildup of excessive stresses resulting from the restraints against the expansion, the excessive stresses can cause the concrete joint or crack to buckle or blowup. An example of a buckled joint on Hwy 14 in Rock county is shown in Figure 1. In this report, we are using the following terminology:

- Buckling (*verb*) is the phenomenon of slab expansion and buildup of excessive stresses at or near concrete joints or cracks resulting in associated failure of the concrete.
- Blowup (*noun*) is the visible distress resulting from buckling. Blowup is also referred to as buckle in some references.



**Figure 1. Blowup on Hwy 14 in Rock county (Courtesy: Rock County Sheriff's Office).**

Buckling is detrimental to concrete pavements not only because they result in localized catastrophic and significant failure of the pavement, requiring immediate repair, which is expensive, time-consuming, and can be difficult, but also because they have a major effect on public safety and mobility (Smith et al. 1987). An example of a recently buckled joint on I-39 SB in Columbia county that has been temporarily filled with asphalt patching material, before a more permanent full depth repair can be performed, is shown in Figure 2.



**Figure 2. Recently buckled joint on I-39 SB in Columbia county, WI.**

Because of the severity of the consequences of buckling, there is a need to better understand the mechanisms behind buckling as well as the factors contributing to increased occurrences of buckling, to perform mitigation activities and reduce future blowups. The objectives of this study are to provide the Wisconsin Department of Transportation (WisDOT) the following:

1. Investigate buckling of concrete pavements in Wisconsin roadways,
2. Reveal the key mechanisms for buckling in Wisconsin with forensic studies, and
3. Identify methods to mitigate buckling and associated costs.

## **Mechanisms of Buckling**

Buckling is a phenomenon that develops over time and has many potential contributing factors and mechanisms, with each one posing some level of risk that buckling may develop on a specific project or even a specific joint.

Past investigations (Smith 1987; Burke 1998; Kerr and Shade 1984; Kerr and Dallis 1985) show that as the temperature and/or moisture in a slab increases, the slabs expand in length (and volume). Countering this expansion is restraint from the surrounding slabs, tie bars, dowel bars, and the friction between the slab and the underlying base layer, and ultimately, any incompressible materials that have infiltrated into the transverse joints and cracks. These confining restraints result in axial, compressive stresses (or forces) within the slabs. As the restraint increases over time, for example, due to additional incompressible materials or other changes in the slab geometry from curling and warping, and/or the concrete weakens over time due to accumulation of axial damage or durability distresses, the compressive stress reaches a critical level at some local point across the slab and exceeds the local concrete strength. The concrete pavement is forced to release the buildup of compressive energy, through a sudden lift-off blowup near the areas of reduced stiffness (typically at transverse joints and/or working cracks).

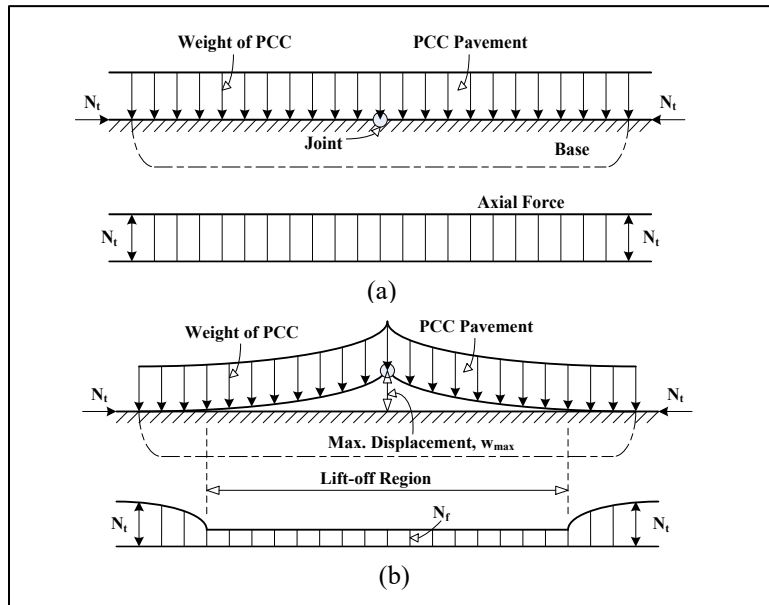
In the past, a common belief was that buckling primarily occurred in jointed reinforced concrete pavements (JRCP) with longer joint spacing due to the larger amount of thermal expansion/contraction of the slabs. However, recent literature and incidences of buckling in states like Wisconsin and Iowa clearly show that buckling also occurs in jointed plain concrete pavements (JPCP) with shorter joint spacing, and even in continuously reinforced concrete pavements (CRCP) (Harrington et al. 2018).

### **Kerr and Shade (1984), Kerr and Dallas (1985)**

Compressive forces induced by increased temperature and/or moisture are key drivers of buckling. Therefore, it is first necessary to define a reference temperature at which the axial, compressive force within the concrete pavement is zero after construction. This temperature represents the temperature at which the PCC material solidified to form the hardened slab and is referred to as the slab's "neutral temperature" (Kerr and Dallis 1985). When the slab is subjected to a temperature higher than this neutral temperature, the compressive stresses start to accumulate within the slabs as schematically shown in Figure 3a (Kerr and Shade 1984). When

this compressive stress becomes excessive, the stresses will eventually be released through buckling of the concrete pavement, as schematically shown in Figure 3b.

In addition to temperature, moisture also plays a significant role in the expansion and contraction of the concrete slab. About the same time that the concrete reaches its “neutral temperature” the moisture in the slab begins to evaporate and interact chemically with the cement to form hardened concrete. Concrete also develops a permanent (ultimate) shrinkage over time as more and more moisture is lost, which is in the order of 50 percent of the total shrinkage. This moisture loss provides some relief in terms of the development of compressive stresses over time. During the service life of the pavement, the concrete is also subject to daily and seasonal moisture changes from precipitation and relative humidity, impacting humidity in the concrete, and these can affect the buildup of compressive stresses in the slab.



**Figure 3. Axial forces in a rigid pavement (a) before and (b) after buckling (Kerr and Shade 1984)**

**Stott and Brook 1968, McBride and Decker 1975**

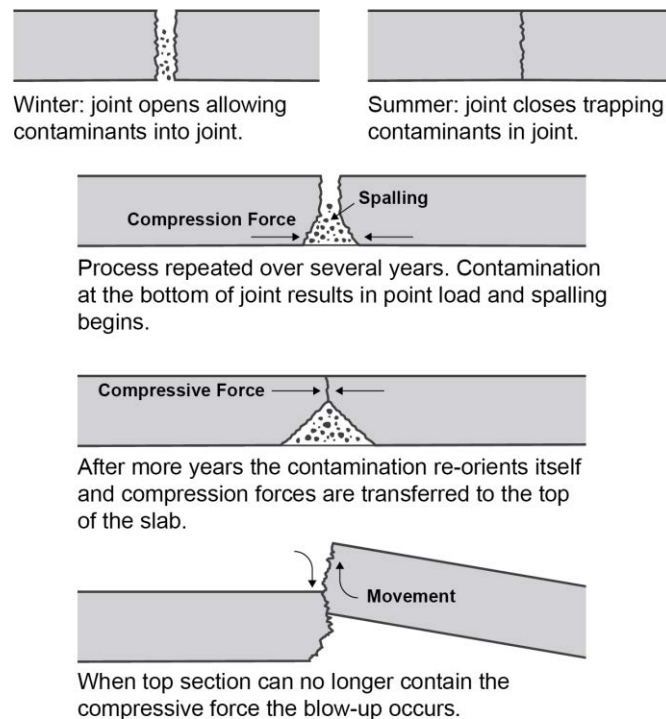
Another mechanism of buckling was developed and described based on the infiltration of incompressible materials into the transverse joints (McBride and Decker 1975, Stott and Brook 1968). The theory of the mechanism can be explained as follows:

- Materials infiltrate into open joints—during the service life of the pavement, but particularly during the winter months when the joints are fully open—from either the top



surface of the road or the migration of fines materials from base layer, or from dislodged material in the joint itself.

- This material settles at the bottom of the joints due to gravity.
- In summer, the joints close and therefore local concentration of compression occurs, which spalls the joints.
- Over several years, the spalled materials accumulate at the bottom of the joint, which aggravates further spalling at the bottom of the joints.
- Over time, the compression is transferred to the relatively sound tops of the slabs. This may happen because the infiltrated material reorients itself in the joints so that it will no longer transmit compression between the bottoms of the slabs.
- The relatively sound tops of the slabs present a reduced area to the compression force and an upward eccentricity so there is a greater potential for blowup than in the original sound slab. Figure 4 (adapted from McBride and Decker 1975) depicts this mechanism of pavement buckling.



**Figure 4. Mechanism of pavement buckling (adapted from McBride and Decker 1975).**

## **Burke (1987)**

Burke (1987) suggested that pavement blowups are an indication of localized high pressures at contraction joints rather than generalized longitudinally oriented compressive stresses existing through the length of the pavement. Figure 5 depicts the cyclic movement of a pavement contraction joint along with the effect of incompressibles during these movements.

These cyclic movements can be described as follows:

- Concrete shrinks about 0.0005 in/in strain of its length as it dries from a saturated to a dry condition. Most of the shrinkage can be recovered from rewetting. The initial shrinkage of the average pavement was assumed as 0.0003 in/in strain since the bottom of a concrete pavement retains a substantial amount of moisture. Figure 5a illustrates the initial cracking of construction joint due to shrinkage (i.e., loss of moisture).
- The initial crack of construction joint contract and expand due to the changes in ambient temperature as illustrated in Figure 5b and Figure 5c. With many cyclic movements of construction joint due to daily/hourly temperature/moisture fluctuations, infiltration of incompressibles begins to fill the joints.
- After joints are filled with incompressibles, the cyclic movements of construction joints are restrained as depicted in Figure 5d.
- The maximum yearly compressive stress generation in a pavement is shown in Figure 6 (curve a). The stress generation is described as follows: the stress initially induced due to environment load is insignificant because the joint is generally clean and joint seal is in good condition.
- Over time, incompressibles start to infiltrate into the joints resulting in a high growth rate of the yearly maximum compressive stress.
- The growth rate of the compressive stress will be reduced/slowed as the joints become filled with incompressibles.
- Based on the hypothesized pressure generation curve, the compressive stress of the pavement will tend to fracture near a joint to release some of the built-up pressure or pavement buckles to release all the pressure at the location of blowups.
- As illustrated in Figure 6, when a pavement buckled, a full-depth repair will be made. As a result, the compressive stress generation starts again and continues at a generally faster

rate (curve c) resulting in pavement distress, fracture, or blowups if joints are not maintained in good condition.

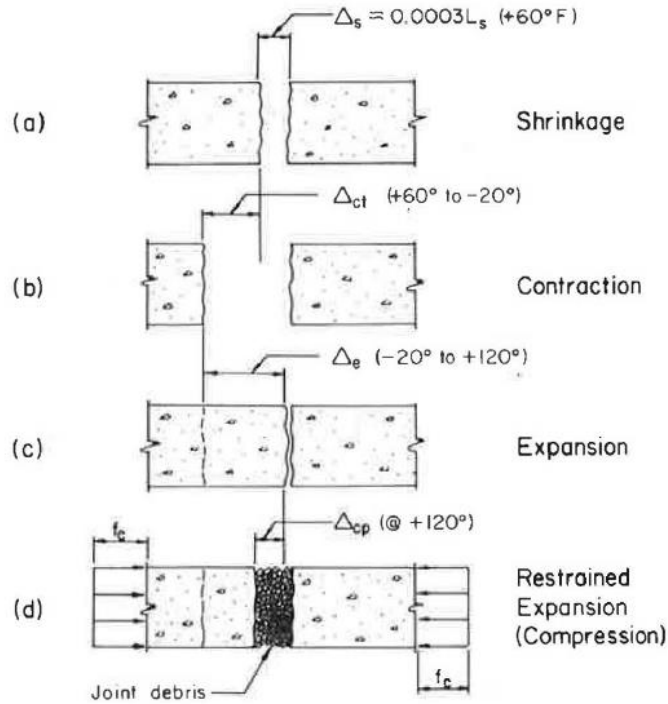


Figure 5. Cyclic movement at construction joints (Burke 1987).

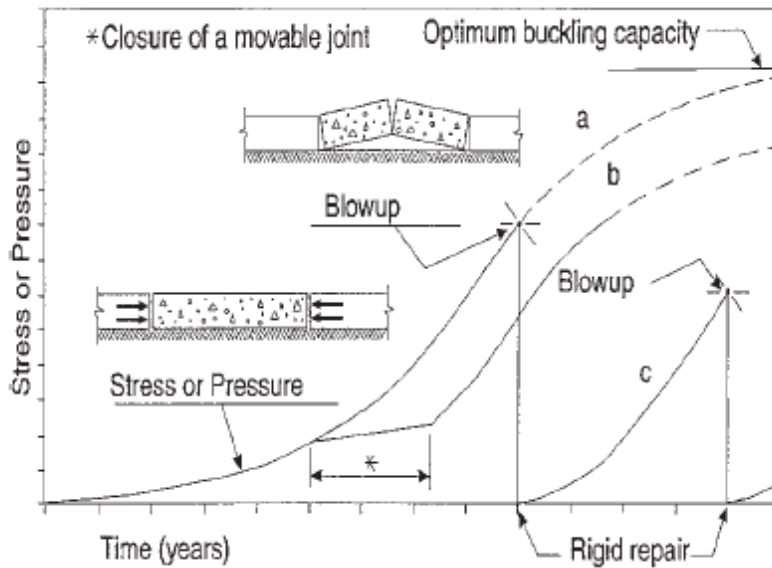


Figure 6. Hypothesized stress or pressure generation curves for jointed pavement (Burke 1998).

### **Shober and Rutkowski (1996) and Shober (1997)**

In 1996, Shober (WisDOT Chief Pavement and Research Engineer at the time) and Rutkowski (WisDOT Research Project Engineer at the time), published “On Joint Sealing and Bearing Systems for Concrete Structures” in the 4<sup>th</sup> ACI Word Congress, and in 1997, Shober published “The Great Unsealing: A Perspective on Portland Cement Concrete Joint Sealing” in the Transportation Research Record.

Based on data collected by WisDOT, the authors posited that not sealing or filling transverse joints does not have a detrimental effect on concrete pavement performance. As such, they state that in 1990, WisDOT passed a policy eliminating all PCC joint sealing (in new construction and maintenance) and that the “no-seal” policy has saved Wisconsin \$6,000,000 annually with no loss in pavement performance and with increased customer safety and convenience.

The authors suggest that even well-sealed joints deteriorate and become partially unsealed and that this partially sealed condition allows incompressible material to enter the joint but only at the discrete locations of sealant failure. By contrast, they state that Wisconsin’s unsealed joints, which are sawed 1/8- to 1/4-inch wide become uniformly filled with fine incompressible material except for the top one inch or so, which is kept clear by traffic action. According to the authors, when the PCC expands, the stress is uniformly distributed across the entire cross section rather than the discrete locations of the sealant failure in sealed joints. They suggest that this uniform stress is well below the compressive strength of the concrete and as such are less prone to failures as compared to joints with sealant failure with higher concentration of localized stresses.

Much of the authors’ discussion on failure pertains to joint spalling and its impact on pavement performance. With regards to incompressibles and buckling, the authors state that “it appears the old axiom (that water and incompressibles must be kept out of a pavement joint in order to get good pavement performance) is not true” and “incidentally, blowups were a major problem in Wisconsin for pavements with 80- and 100-foot joint spacings. The use of closer joint spacings (15 to 20 feet) has virtually eliminated blowups. Blowups are not significantly influenced by joint sealing.” The authors specifically state that “blowups are a function of joint spacing, not joint sealing.”

## Factors Impacting Buckling

Although the mechanisms described above are simple to understand, the probability of occurrence of buckling increases due to a variety of factors (termed risk factors) that affect the pavement's neutral temperature, magnitude of temperature and moisture increase, and the accumulation of compressive stresses over time. These risk factors identified in several references including McBride and Decker (1975), Burke (1998), and Kerr and Shade (1984), are detailed in Appendix A, and are summarized below:

- Climatic conditions during construction: Because temperature and moisture are key drivers of buckling, climatic conditions, both during construction, and during the service life of the pavement, have a major impact on the mechanisms just described. Climatic conditions (temperature, humidity, wind, solar radiation, etc.) during construction impacts the formation of the crack beneath the transverse joint and the amount of opening available for slabs to expand during the service life of the pavement. In addition, conditions during construction impacts properties of concrete such as strength and durability, which can also impact buckling.
- Climate during service life: Climatic conditions, particularly, temperature and moisture/humidity during the life of the pavement are key drivers of buckling. A statistical analysis on the occurrences of concrete pavement buckling showed that 90 percent of buckling occurred when the air temperature was equal or greater than 90 °F, 72.8 percent in the month of June, 85 percent between 1:00 to 6:00 P.M., and 75 percent within a week of rain (Illinois Division of Highways 1957).
- Incompressible materials infiltrating the joints: The amount, size, and hardness of incompressible materials infiltrating into the joint from the top and from the bottom (pumping of the base/subgrade) over time has a direct impact on the probability of buckling. The greater the infiltration of incompressibles in the joint, the greater the risk of buckling, as it reduces the amount of joint opening available for the PCC slab into which to expand. More details of the impact of incompressibles in transverse joints are discussed in Appendix B.
- Concrete coefficient of thermal expansion (CTE): CTE typically ranges from 4 to  $7 \times 10^{-6}$  in/in/°F based on coarse aggregate type and cement content. The higher the CTE, the

higher the risk for buckling as it directly relates to the increase in PCC length and volume.

- **Strength:** Strength is one of the traditional and important properties of concrete pavement that must meet agency specifications to provide adequate compressive and flexural resistance to stresses. Weaker concrete has higher risk of failure due to buckling. Stronger concrete has a higher capacity to withstand concrete expansion-related stresses by straining to a greater extent before it cracks or fails. Note that it is practically impossible for stresses to be uniformly distributed across the entire cross section at a joint as stated by Shober and Rutkowski (1996) regardless of whether joints are sealed/filled or left unsealed/unfilled. There will always be areas of high stress concentrations and areas of low stress concentrations at any given joint or crack due to spatial variability in how the crack beneath the sawcut forms, temperature curling and moisture warping of the slabs resulting in differences in joint openings between the slab corner and midslab locations, and how, when, and where incompressibles enter the joint.
- **Durability:** Concrete that has been weakened at the joints due to durability distresses such as localized cracking or spalling has increased risk of failure due to buckling because they effectively have lower localized strength and lower capacity to withstand concrete expansion-related stresses.
- **Concrete drying shrinkage:** The amount of permanent drying shrinkage in concrete as it sets, affects joint opening and closing. The greater the drying shrinkage the lower the risk of buckling.
- **Slab/base friction:** Low friction (or bonding) between slab and base course increases the opening and closing of joints/cracks over time. The lower the slab/base friction, the higher the risk of buckling. Treated bases (such as cement-treated bases [CTB] and asphalt-treated bases [ATB]) have higher friction between the base and the PCC layer as compared to unbound aggregate bases.
- **Age:** Many studies have identified pavement age to be a factor that increases the risk of buckling. However, this may be related to increase in amount of incompressible materials infiltrating the joints, increase in joint durability damage over time, and increased spalling, all of which contribute to buckling.

- Set temperature: Slab set temperature at construction depends on the local climatic conditions during construction and specifically when the concrete hardens. The higher the set temperature, the lower the risk of buckling.
- Transverse joint spacing: Transverse joint spacing affects the opening and closing of the transverse joints and buildup of compressive stresses. The longer the joint spacing the higher the risk of buckling.
- Joint formation: Joints that form sooner—called dominant joints—usually open and close the most and become potential locations for increased incompressible materials. These joints or joints adjacent to these joints may have an increased risk of buckling.
- Shoulder type: Limited studies have identified shoulders as being a source of incompressible materials into the transverse joints. As such, pavements with wide shoulders have reduced risk of buckling.
- Asphalt overlay or patching: Concrete slab moisture content increases after an HMA overlay has been placed resulting in increased risk of buckling.
- Joint spalling: Debris from spalls enter the joints increasing the amount of incompressibles in the joints. Severely spalled joints also have lower concrete cross-sectional area at the joints, and thus have less intact concrete to resist the buckling pressure, which translates to higher stresses in the concrete. This is true even if the spalled joints are filled with asphalt patching material, which offers little resistance to the buckling pressure. As such, spalled joints are generally an indicator or precursor event signifying an increased potential for buckling at or near the spalled joint. More details of the impact of transverse joint spalling are discussed in Appendix C.
- Maintenance: The spall or cracking maintenance repairs of all types of concrete pavements can increase the risk of buckling if not done properly. Partial depth patching that simply removes the loose concrete particles in a spalled area and replaces it with hot or cold asphalt mix results in a highly variable face along the transverse joint that could lead to high localized compressive stresses and a blowup. Replacement with a concrete partial depth patch provides more structure that can bear horizontal compression stresses. Full-depth asphalt repairs placed in any portion of a traffic lane will often result in being compressed by the adjacent slabs on both ends causing a very high compressive stress in

any adjacent concrete in the lane or adjacent lanes resulting in a high risk of buckling of the remaining concrete during hot weather.



## **Other Agencies Experiences with Buckling**

Several agencies in the U.S. and internationally have had their own experience with buckling. Some of these experiences have been documented in literature and are summarized in Appendix D.

For the current study, the research team interviewed several State Highway Agencies (SHAs) and industry representatives regarding the relative number of blowups that occur on their highway networks. The information from these interviews is consistent with information obtained from literature and discussed in the previous sections, are summarized in Appendix E.

Based on these anecdotal interviews (rather than a thorough incident rate evaluation), the brief descriptions of the occurrences of buckling in jurisdictions outside of Wisconsin point to the apparent fact that for most agencies, buckling is not a significant problem and very few occur in a typical year (e.g., Minnesota, California, Georgia, Washington, Oregon, Utah, Illinois Tollway), but there are other states like Iowa that experiences higher rates of buckling, and Wisconsin that currently exhibit over 100 blowups per year with the number of blowups have been steadily increasing each year since 2013.

A significant difference between Wisconsin practices and those of neighboring agencies that have fewer occurrences and smaller probability of buckled joints has to do with design, and specifically joint design and drainage design, and in the maintenance and rehabilitation treatments and practices. For the current study, the research team reviewed practices and designs from six neighboring agencies (Iowa, Illinois, Minnesota, Michigan, Indiana, and Ontario). These are summarized in Table 1 with additional details included in Appendix F.

Most of the agencies interviewed and whose practices were reviewed by the research team, seal or fill their JPCP transverse joints. By contrast, Wisconsin uses a single saw cut for the JPCP transverse joint that is left unsealed or unfilled throughout the life of the pavement. This has been a WisDOT practice since 1990. All the buckling literature including the research team's own experience with buckling, suggests that leaving the transverse joint unsealed/unfilled throughout the life of the pavement results in incompressibles collecting in the joints. The incompressibles in the transverse joints increase over time resulting in a decrease in the potential of the joint to close when the concrete expands during the summer months, thus increasing the likelihood of buckling.

**Table 1. Neighboring agency practices relevant summary.**

Agency	Joints	Subsurface Drainage	Cold-Weather Concreting
Iowa	<p>Transverse joint spacing is 12 feet for slabs 6 inches thick, 15 feet for slabs 7 to 9 inches thick, and a maximum of 17 feet for slabs over 10 inches thick.</p> <p>Unsealed plain contraction joints are used when the slab is less than 8 inches thick.</p> <p>Doweled joints are used when a slab is over 8-inch thick and where pavement carries more than 100 trucks per lane per day.</p> <p>Doweled contraction joints are sealed and sawed (single saw cut ¼-inch wide) to a depth of one third the PCC thickness (T/3) using conventional sawing equipment.</p> <p>Optionally, doweled contraction joints are sealed and sawed (single saw cut 1/8-inch wide) to a depth of 1¼-inch using approved early sawing equipment.</p>	<p>Drainage layer includes a permeable granular layer and a subdrain.</p> <p>Granular subbase is typically used under concrete pavement and modified subbase is used under asphalt pavement or when the base needs to be driven on during staging and/or paving.</p> <p>The drainage layer is located under the pavement. Drainage with longitudinal subdrains is mandatory with granular subbase and modified subbase, but not with special backfill.</p>	<p>Protect concrete pavement less than 36 hours old as specified in protection requirements.</p> <p>35°F to 32°: One layer of burlap for concrete.</p> <p>31°F to 25°F: Two layers of burlap or one layer of plastic on one layer of burlap.</p> <p>Below 25°F: Four layers of burlap between layers of 4 mil plastic, insulation blankets meeting the requirements below, or equivalent commercial insulating material approved by the Engineer.</p> <p>Protection shall remain overnight the first night covering is required. After the first night of covering, protection may be removed when specified conditions are met.</p> <p>Shut down paving operations in time to comply with protection requirements. The cover may be temporarily removed to perform sawing or sealing.</p>
Illinois	<p>Transverse joints are not sealed, because they are typically narrow and because unsealed transverse joints reduce vehicular noise.</p> <p>If concrete pavement is placed on stabilized base course, a hot poured joint sealant is required for transverse contraction joints.</p> <p>The maximum transverse joint spacing allowed is 15 feet. Transverse joint spacing depends on the pavement thickness; the maximum transverse joint spacing is 12 feet, if pavement thickness is less than 10 inches, and the maximum transverse joint spacing is 15 feet if pavement thickness is 10 inches or above.</p>	<p>Open graded drainage layer (OGDL) is used to drain water into edge drain system.</p> <p>Stabilized asphalt drainage layer or lean concrete base can be used for concrete pavement.</p> <p>OGDL can be placed as one layer between 3- to 6-inches thick.</p>	<p>Cold weather is defined as whenever the average ambient air temperature during day or night drops below 40 °F.</p> <p>The contractor must make the necessary adjustments so that the concrete temperature is maintained from 50 °F to 90 °F for placement. Acceptable methods include heating mixing water and/or heating the aggregate.</p> <p>Paving or placing concrete on a frozen base, subbase, or subgrade is prohibited. The base, subbase, or subgrade on which the concrete is to be placed shall be thawed and heated to at least 40 °F.</p> <p>The contractor shall protect the concrete in such a manner as to maintain a concrete temperature of at least 50 °F for 10 days. The method of concrete protection shall be by use of insulating layer or heated enclosure around the concrete.</p>

Agency	Joints	Subsurface Drainage	Cold-Weather Concreting
Minnesota	<p>The standard practice of Minnesota DOT is not to seal any contraction joints on concrete pavement, except for some specific situations.</p> <p>Standard contraction joints for concrete pavements are typically doweled and the sawcut depth is 1/4 of the slab thickness.</p> <p>The maximum transverse joint spacing is 15 feet regardless of slab thickness. The rule of thumb of panel joint spacing is equal to 1.5 feet times the slab thickness in inches.</p>	<p>Minnesota DOT uses either daylighting or subsurface drains to remove excess subsurface water.</p> <p>Subsurface drain layer for new/reconstructed concrete pavements can be an open-graded aggregate base (OGAB) or drainable stabilized base (DSB) with edge drains, a 4-inch thick permeable asphalt stabilized base (PASB) with edge drains, or geo-composite joint drain that drains into either edge drains or a daylighted layer.</p>	<p>If the national weather service forecast for the construction area predicts air temperatures of 36 °F or less within the next 24 hours and the Contractor wishes to place concrete, submit a cold weather protection plan.</p> <p>Maintain concrete temperature from 50 °F to 90 °F until placement. Contractor must use proper judgement in assuring that the concrete pavement does not freeze.</p> <p>These guidelines are considered to be the minimum protection against frost, use of these guidelines does not guarantee concrete won't freeze or sustain other cold weather damage.</p> <p>One sheet of plastic: If overnight low temperature is expected to be from approximately 3 to 6 degrees Fahrenheit below freezing.</p> <p>Two sheets of plastic: If overnight low temperature is expected to be from approximately 7 to 10 degrees Fahrenheit below freezing.</p> <p>Straw or similar insulating material: If overnight low temperature is expected to be approximately 10 degrees or more below freezing.</p>
Michigan	<p>Transverse contraction joints are sealed with low modulus hot-poured rubber asphalt type joint sealing compound.</p> <p>Backer rod is used. The groove depth is 1.375 to 1.5 inch. The sawcut width of transverse joint is ¼ inch and depth is ¼ of PCC thickness less than or equal to 7 inches (T/4).</p> <p>The depth of sawcut is 1/3 of PCC thickness for greater than 7 inches (T/3).</p>	<p>The maximum thickness of open graded drainage course (OGDC) must not exceed 10 inches and typically 6-inch thick OGDC is used for subsurface drainage.</p> <p>OGDC is placed below the pavement surface. Geotextile or dense-graded aggregate separator layer can be used between the OGDC and subbase or subgrade.</p> <p>Subgrade and subbase underdrains were also described in DOT's road design manual. The application of subgrade drain is to drain subgrade</p>	<p>Cold weather is determined to occur when the air temperature has fallen to, or is expected to fall below 40 °F.</p> <p>Do not place concrete if the air temperature is below 40 °F, unless form interiors, metal surfaces, and the adjacent concrete surfaces are preheated to at least 40 °F.</p> <p>Do not begin placing concrete if the air temperature is below 35 °F unless a specific cold weather quality control plan has been approved by the Engineer.</p> <p>During cold weather, use measures to protect the concrete following placement and continuing until the concrete has reached its open to traffic strength. Provide concrete that has a minimum temperature of 55 °F at time of placement.</p>

Agency	Joints	Subsurface Drainage	Cold-Weather Concreting
		<p>and subbase while subbase underdrain is to only drain the subbase.</p> <p>Subbase underdrain is placed below the dense-graded aggregate base. Subbase underdrain pipe should be warped with geotextile.</p>	<p>If the National Weather Service forecasts air temperatures below 20 °F during the curing period, provide material and heating equipment on the project to protect forms and concrete.</p> <p>Cold weather protection shall consist of a method or combination of methods that ensure the concrete temperature will be maintained above 50 °F from the time that it is placed until the concrete attains opening to traffic strength.</p> <p>Methods may consist of heating concrete ingredients, adding chemical accelerators, or physically covering the concrete with a protective barrier such as plastic sheeting, frost paper, insulating blankets, straw over plastic, or other methods approved by the Engineer.</p>
Indiana	<p>The maximum transverse contraction joint spacing shall not exceed 18 ft.</p> <p>The sawcut width is ¼ inch and depth is 1/3 of pavement thickness (T/3).</p> <p>Joints are sealed with hot poured joint sealant in accordance with sealant manufacturer's recommendations.</p> <p>Joint should be cleaned before sealing and water blasting shall not be applied under pressure to avoid damage the concrete.</p>	<p>Subbase layer for concrete pavement should consist of 3 inches of aggregate No. 8 as the aggregate drainage layer placed over a #53 6-inch coarse aggregate as the separation layer.</p> <p>The moisture content of aggregate is specified to be between 4 percent of the optimum moisture content before placement.</p> <p>Drainage layers for concrete pavement are aggregate drainage layer or open graded asphalt layer (asphalt treated permeable base).</p> <p>Open graded asphalt layer is typically placed at 250 lb/yd<sup>2</sup> to 300 lb/yd<sup>2</sup>.</p> <p>Geotextile or aggregate can be used as a separator layer to prevent pumping of</p>	<p>When it is necessary to place concrete at or below an atmospheric temperature of 35 °F, or whenever it is determined that the temperature may fall below 35 °F within the curing period, the water, aggregates, or both shall be heated, and suitable enclosures and heating devices provided.</p> <p>Cold weather concrete shall be placed at the risk of the Contractor and shall be removed and replaced with no additional payment if it becomes frozen or otherwise damaged.</p> <p>When aggregates or water are heated, the resulting concrete shall have a temperature of at least 50 °F and not more than 80 °F at the time of placing.</p> <p>The maximum temperature of concrete produced with heated aggregates shall be 90 °F. Neither aggregates nor water used for mixing shall be heated to a temperature exceeding 150 °F.</p> <p>When aggregates or water are heated to 100 °F or above, they shall be combined first in the mixer before the cement is added.</p> <p>Immediately after a pour is completed, the freshly poured concrete and forms shall be covered so as to form a complete</p>

Agency	Joints	Subsurface Drainage	Cold-Weather Concreting
		<p>erodible subgrade materials.</p>	<p>protective enclosure around the element being poured. The air within the entire enclosure shall be maintained at a temperature above 50 °F for a minimum of 144 h for bridge decks, the top surface of reinforced concrete slab bridges, and for a minimum of 72 h for all other concrete.</p> <p>If for any reason this minimum temperature is not maintained, the heating period shall be extended.</p> <p>All necessary measures shall be taken during protective heating to keep the heating equipment in continuous operation and to ensure maintenance of the proper temperature around all sides, top and bottom of the concrete.</p> <p>The curing compound may be warmed in a water bath during cold weather at a temperature not exceeding 100 °F.</p>
Ontario	<p>Contraction joint maximum of ¼ inch wide joint filled with a low-modulus joint sealant.</p>	<p>MTO drainage system include subdrains, granular sheeting or open-graded drainage layers (OGDL).</p> <p>The thickness of the OGDL is specified be 4 inches and the unit weight is specified to be 1.3 t/yd<sup>3</sup>.</p> <p>The OGDL is placed below concrete pavement and above a granular base course.</p> <p>The OGDL permeability values range from 4 to 0.04 in/sec.</p> <p>The MTO standards include stabilized OGDL treated with either 1.5 to 2.0 percent asphalt cement or 265 to 397 lb./ton of hydraulic cement.</p>	<p>Concrete shall not be placed when the ambient air temperature is below 32 °F and shall not be placed against any material whose temperature is below 41 °F.</p> <p>The Contractor shall provide protection to ensure the minimum in-place temperature of the concrete pavement or concrete base is 59 °F for the first three days of curing, and at 50 °F for the subsequent 4 days.</p> <p>Concrete shall not be placed by slip-forming when the air temperature is below 32 °F. Placing concrete by slip-forming shall not be carried out when the air temperature is below 41 °F unless the concrete at the time of placing is between 59 °F and 86 °F.</p> <p>When the concrete pavement or concrete base requires protection by insulation, no more than 82 linear feet of concrete pavement or concrete base shall be exposed for sawcutting operations at any one time.</p> <p>In no case shall any concrete pavement or concrete base be exposed for more than one hour during sawcutting.</p>

## Field Investigation

The purpose of the field investigation was to identify and capture potential factors that contribute to buckling in Wisconsin. The investigation entailed forensic inspection of pavements that exhibited blowups and comparing them with control pavements of similar characteristics that exhibit lower or no occurrences of blowups. The research team visited the selected buckling and control sites in September and October 2020.

The number of blowups in each year between 2013 and 2021 are shown in Figure 7 and the geographic distribution of the blowups from 2013 to 2019 is shown in Figure 8. The rate of buckling generally increased every year with the highest number of blowups in 2021. A significant number of blowups have occurred between 2019 and 2021, which is considerably higher than the number of blowups between 2013 and 2018. Most of these blowups occurred on JPCP with a joint spacing of 15 and 18 ft. The different markers in Figure 8 correspond to different years with the green with white center markers representing blowups in 2019. The occurrences of pavement blowups can be summarized as follow:

- 83 percent of blowups occurred when the surface temperature estimated at the time of blowup was equal to or greater than 90 °F.
- 40 percent of blowups occurred in the month of June, 30 percent in the month of July, and 25 percent in the month of May.
- 82 percent of blowups occurred between 2:00 and 7:30 pm.
- Buckling is distributed throughout Wisconsin and corresponds primarily to the density of the concrete pavement roadway network.

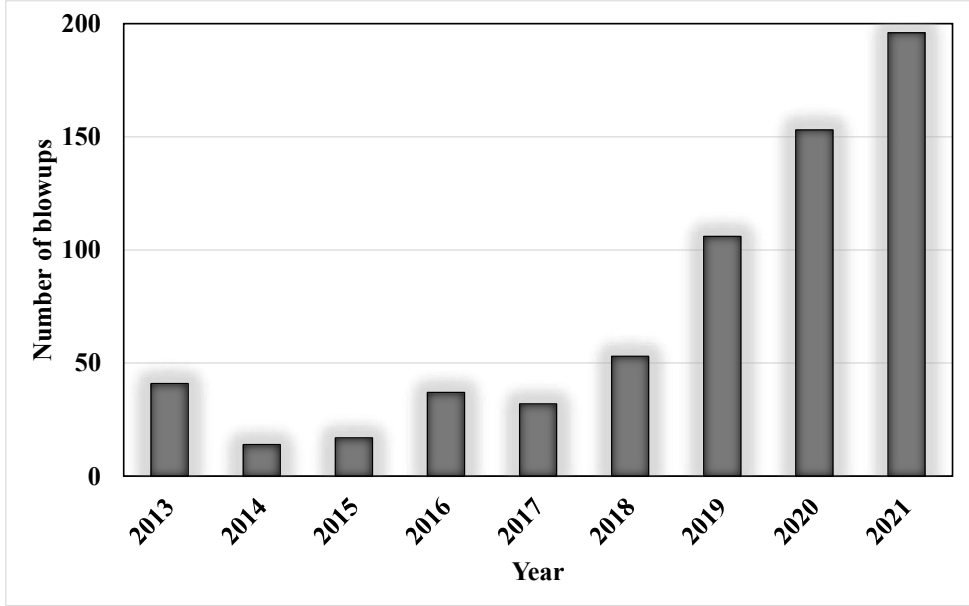


Figure 7. Number of blowups in Wisconsin between 2013 and 2021.

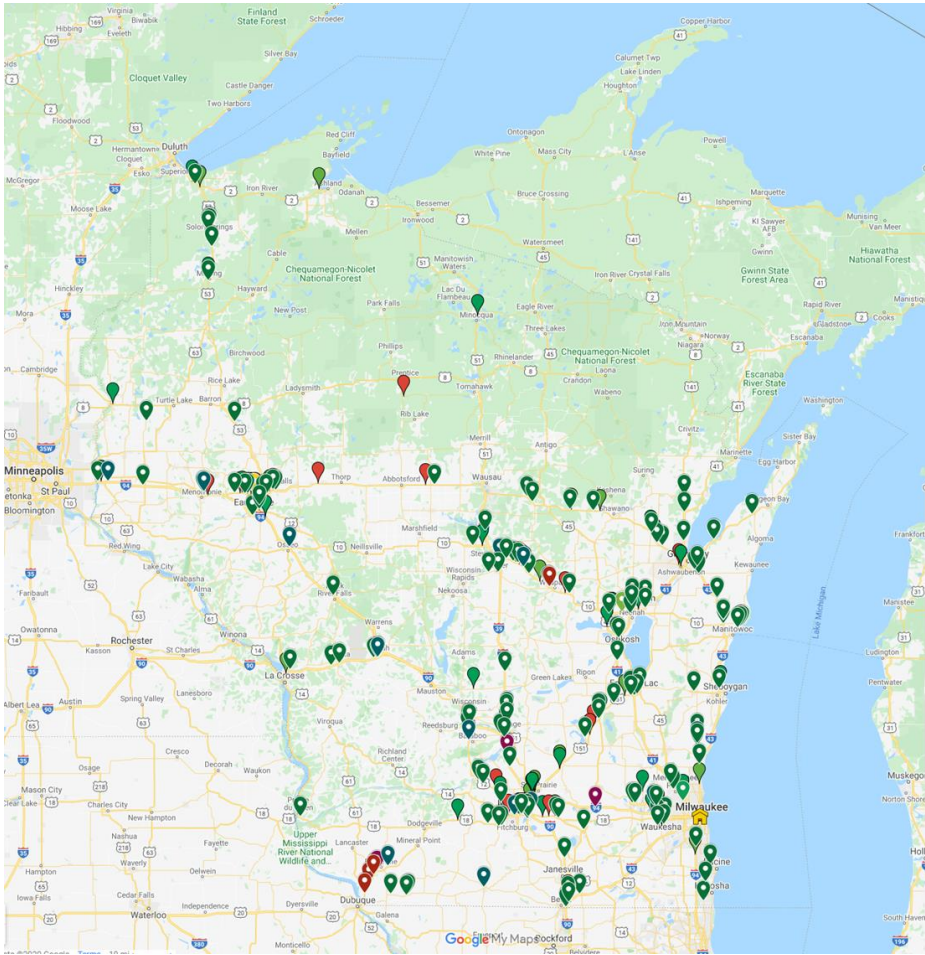


Figure 8. Geographic distribution of blowups in Wisconsin between 2013 and 2019.

## Site Selection

A total of 11 sites in various counties in Wisconsin were approved by members of the Project Oversight Committee (POC). Buckling and control sites were selected based on the following criteria.

- Type of pavement distress and durability,
- Previous maintenance activities,
- Pavement geometry/grades (flat, uphill, downhill grades),
- Geographical location in Wisconsin,
- Class of highway (interstate, state highway, or local street),
- Number and history of blowups over the years,
- Ability to close the traffic lane safely to conduct testing and coring operation, and
- Pavement design.

Eight of these 11 sites were selected for field evaluation. Three control sites located near 3 of the 8 buckling sites were identified. These control sites represent portions of the roadway or nearby roadways where buckling has not occurred, or incidences of buckling were deemed to be low. Table 2 and Figure 9 show the selected buckling and control sites for the field evaluation. All sites were two-lane divided highways except for site # 11, which was a one-lane ramp.

**Table 2. Buckling sites for field forensic investigation.**

Site No.	County	Location	Joint spacing	PCC thickness	Year built	Shoulder	Widened Lane?
1	Portage	U.S. 10 WB	15	10	2007	6 ft (A)	Y
2	Chippewa	U.S. 29 WB	18	10	2005	6 ft (A)	Y
3	Dane	U.S. 12/18 WB	15	9.5	1998	4 ft (A)	Y
4	Columbia	I-39 SB	18	10	2004	6 ft (A)	Y
7	Eau Claire	U.S. 53 NB	15	9.5	2006	6 ft (A)	Y
8	Fond du Lac	U.S. 151 SB	15	10	2007	4 ft (A)	Y
10	Sauk	U.S. 12 EB	15	10	2011	6 ft (A)	Y
11	Racine	Ramp I-94	14	7	2009**	4 ft (C)	N
1*	Portage	U.S. 12/10 WB	15	10	2012	6 ft (A)	Y
2*	Dane	I-94 EB	15	11.5	2011	12 ft (C)	N
3*	Fond du Lac	U.S. 151 SB	15	10	2007	6 ft (A)	Y

\*control sites.

\*\*mainline was paved in 2009.

(A) = asphalt shoulder, (C) = concrete shoulder.





**Figure 9. Geographical locations of selected buckling and control sites.**

### **Description of Field Survey**

Prior to the field survey, Google Earth Pro® was used to examine the specific joint or crack in Wisconsin where the blowup occurred and document its condition over time, if available. The examination provided limited ability to observe concrete pavement distresses and did not provide time series images for all sites. In addition, more recent images are of higher quality than older images. Field investigation for each site included:

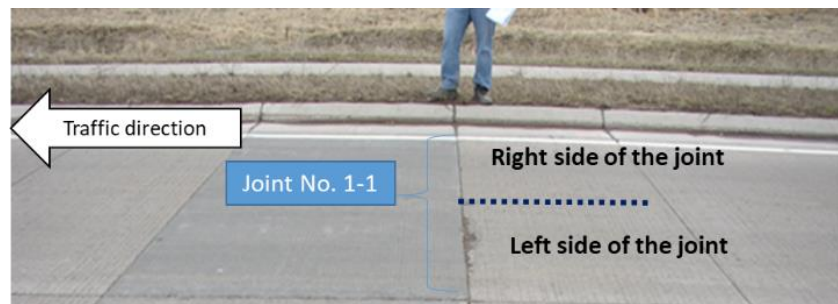
- Visual inspection of roadway conditions,
- Evaluation of joint conditions,
- Coring,
- Evaluation of subsurface drainage system,
- Evaluation of pavement geometrical parameters, and
- Pulse induction scanning for dowel alignment.

The visual survey was conducted to assess the overall pavement condition(s) impacting the occurrence of buckling for the project. The field investigation included a visual inspection of

the adjacent pavement, and evaluation of joint condition, roadway geometry, and surface/subsurface drainage. The research team evaluated and documented the joint conditions/performance including the presence of incompressibles in the transverse joints and the joint width.

Two methods were used to determine the infiltration of incompressibles into the joints. The incompressible materials were determined by observing several joints and digging into the joint with a knife to estimate the amount of incompressibles, and by coring directly through the joint and opening the core to examine the joint face.

The amount of incompressibles in a joint were estimated based on a visual rating. To improve the visual rating of the incompressibles in a joint, each joint was divided into two segments and each segment was evaluated based on the visual rating (Figure 10). The visual rating was converted to a numerical scale as follows: 0 (None), 1 (Low), 2 (Moderate) and 3 (High) for each segment and the rating for the two segments was summed to provide an incompressibles rating index from 0 to 6 for each joint, as presented in Table 3. The reason for dividing a joint into two segments is that incompressible materials into a joint are typically not uniformly distributed along a joint, especially if gravel shoulder is used instead of paved (e.g., asphalt or PCC) shoulder and/or spalling/cracking is present only on one side of a joint.



**Figure 10. Each joint was divided into two equal segments for visual evaluation of incompressibles.**

**Table 3. Template of incompressible materials survey.**

Site and joint number	Visual rating		Numerical rating		Incompressibles rating index	Joint treatment	Spall depth (inch)	Joint depth (inch)	Spall observation	Joint width (inch)
	Right side	Left side	Right side	Left side						
1-1	None	Low	0	1	0 + 1 = 1	No sealant	~ 1.5	0.5 – 1	Left side	1/4
1-2	Low	High	1	3	1 + 3 = 4	Sealant*	~ 2.0	0.5 – 3.5	Left side	1/4

\*This template was developed before the field visit. 100 percent of joints surveyed in Wisconsin during field visit had “no sealant” as the joint treatment.

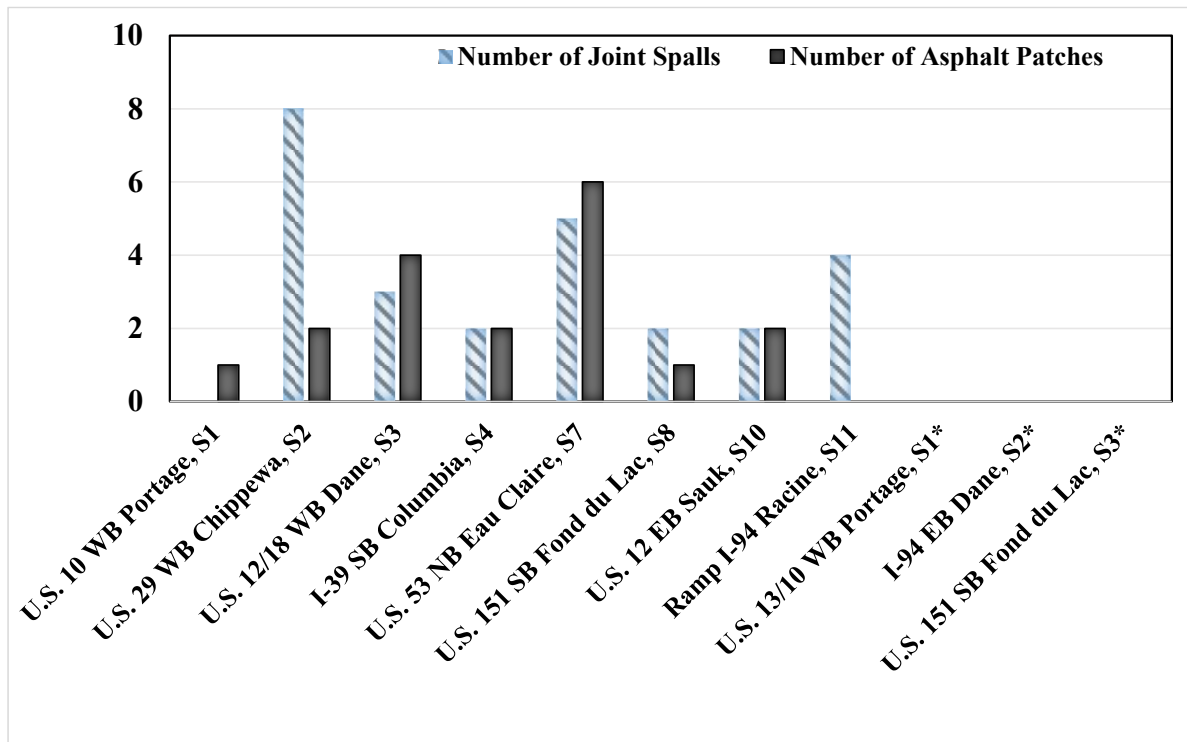
Six cores were taken from each of the buckling and control sites, except for two sites, where four cores were taken due to weather conditions and other issues at the site. Joints adjacent to the buckling joint were cored to observe the amount of incompressibles, the depth of sealant if present, spalling, and the condition of the bottom portion of the joint. Pulse induction testing was conducted at some sites by WisDOT engineers to evaluate dowel bar alignment.

## Results and Discussions of Field Survey

This section describes the results and findings from the field survey for the eight buckling sites and three control sites. Several parameters including transverse joint conditions (spalling and patching), incompressible materials, and drainage systems, were evaluated to identify their impact on the occurrence of blowups.

### Transverse Joint Spalling and Asphalt Patching

The conditions of transverse joints were evaluated through visual inspection and coring for buckling and control sites. The number of joint spalls and asphalt patches were recorded as shown in Figure 11.



**Figure 11. Number of transverse joint spalls (width of spall  $\geq 1.0$  inch) and asphalt patches over a 1,000-ft section for buckling and control sites.**

Each joint over a 1,000 ft. section (roughly 60 to 70 joints) at each site was evaluated. Majority of spalls were observed to have developed on the outer portion of the transverse joint of the traffic lane and fewer spalls were observed to have developed in the inner portion of transverse joints of the traffic lane. Spall widths of 1.0 inch or more were considered and are included in Figure 11. Typically, the size of spalls ranged from 0.5 to 8.0 inches in the longitudinal direction and 0.5 to 8.0 inches in the transverse direction, with a few larger spalls of



the order of 10 to 12 inches in the longitudinal or transverse direction. The depth of the spalls was typically shallow, and of the order of 0.5 to 2 inches. Occasionally the spalls occurred in consecutive joints and most times there were no spalls for many consecutive joints. Other areas showed a random occurrence of spalling from joint to joint. In a few buckling sites, spalls were observed near buckled joints. Overall, there was no consistent pattern from one joint to another or from one site to another.



(top left: I-39 SB Columbia site # 4, top right: U.S. 12 EB Sauk site # 10, bottom left: U.S. 12/18 WB Dane site # 3, bottom right: U.S. 53 NB Eau Claire site # 7)

**Figure 12. Transverse joints showing the outer transverse joint sections with spalling at various levels of severity at different buckling sites.**

Figure 11 also indicates that while all the buckling sites had some amount of spalling or asphalt patching, there was no spalling or asphalt patches observed at any of the three control sites. While this observation, because of the small number of sections and the age of the control sites since construction, is not definitive proof, it is consistent with literature and observations from other agencies and our research team’s experience that spalling and buckling are interrelated, and that spalling may be a precursor to buckling.

This evidence is further supported by the research team’s review of historical Google Earth® images for the buckling sites. For example, U.S. 10 in Portage County (site # 1) surveyed in September 2020, had exhibited one blowup over a 1,000-ft. section. An October 2016 image showed a transverse crack/joint that exhibited spalling and maintenance patching (Figure 13). A transverse crack also developed in both asphalt shoulders. On May 27, 2018 a blowup occurred across both traffic lanes at this crack/joint. This area was then patched with asphalt across both traffic lanes. There was no apparent deterioration of adjacent joints. In this case, buckling appeared to have occurred at a deteriorated joint with spalling, asphalt patching, and cracks.



**Figure 13. Google Earth® images of U.S. 10 in Portage county (site # 1) prior to buckling showing spalls, shoulder cracking, and asphalt patching (left and bottom). Image on the right, collected during the September 2020 field survey shows the same location patched with full-depth asphalt following the blowup.**



Another example of a joint that exhibited spalling and maintenance patching in October 2017 prior to the blowup is presented in Figure 14. Image after buckling dated July 2018 shows a blowup occurred and a full-depth repair was placed across both traffic lanes as a repair for the buckled joint. In both these examples, the deterioration of a joint either contributed to or was a precursor pointing towards future buckling.



**Figure 14. October 2017 Google Earth® images of U.S. 12 prior to buckling showing spalls and asphalt patching (top). July 2018 Google Earth® image of the same joint following buckling (bottom).**

The above observations are also consistent with anecdotal evidence based on interviews with WisDOT personnel. A county engineer from Portage County (U.S. 10 WB site # 2) said that the county observed nine blowups. Seven of the nine blowups had either asphalt patches or spalling. A Sauk County engineer (U.S. 12 EB site # 10) said that nearly 50 percent of blowups occurred when the transverse joint was spalled or patched with asphalt.

### **Cores**

The buckling and control sites were cored through transverse joints and the middle of the slab. The selection of core locations at the sites were based on visual observations. At buckling sites, the location of coring was in the vicinity of the buckling area, whereas at control sites, three random slabs were selected and cored through transverse joints and the middle of the slab.

Cores from buckling sites taken at transverse joints show deterioration and voids or spalls in the lower portion of the joint as shown in Figure 15. The following are some observations from a review of the cores from the buckling sites:

- Voids in the lower portion of the joint were observed in good joints even where spalls, cracks, or otherwise damaged joints were not exhibited on the surface.
- The severity of deterioration of the lower portion of the joint appeared to depend on the opening and closing of the joint due to expansion and contraction, amount of incompressibles infiltrated into the joint and freeze-thaw cycles, as evidenced by the higher joint openings of these deteriorated joints. As such, joint deterioration at the buckling sites might be attributed to damage due to durability issues, incompressibles, or inadequate consolidation, or a combination of these factors.
- Concrete cores taken from joints showed high levels of contamination and potential crushing of incompressibles in the joints. This result is consistent with observations made by McBride and Decker (1975) in Utah.
- The spall at the lower portion of the joint was often located in the bottom area, which coincides with the location where a lot of incompressibles (grit, sand, small pebbles) collect at the joint shrinkage crack due to gravity.





site # 4



site # 10



site # 7



Figure 15. Cores from buckling sites taken from transverse joints and core holes showing spalls in the lower portion of the joint.

Cores from control sites showed overall less deterioration and less or no voids in the lower portion of the joint as shown in Figure 16. The following are some observations from a review of the cores from the control sites:

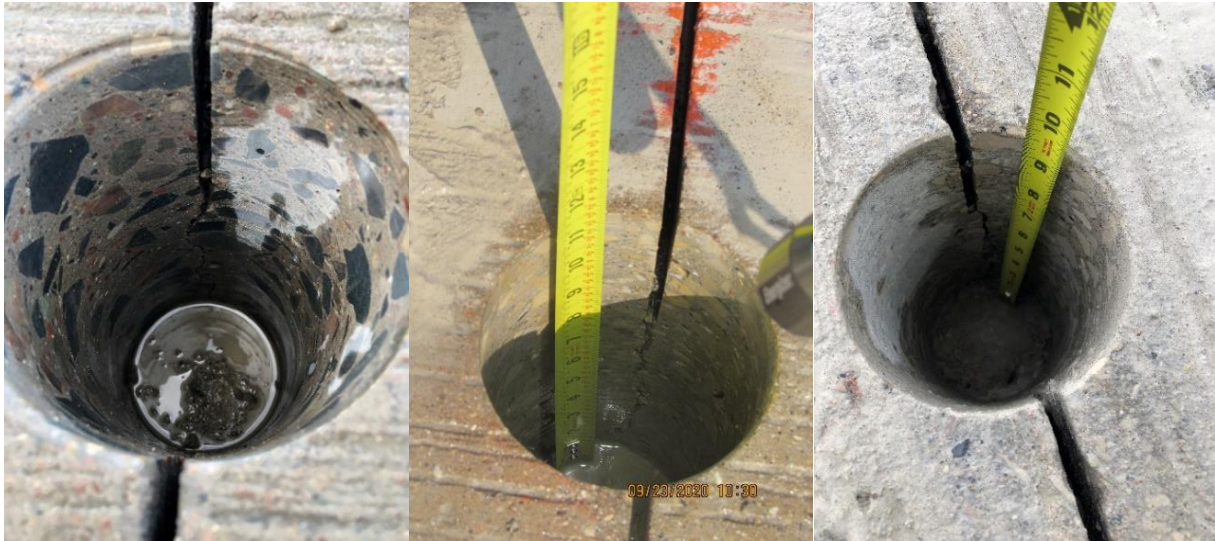
- Spalls or asphalt patches were not detected at the lower portion of the joint or at the surface.
- Cores still showed crushing and contamination below the sawcut areas due to incompressibles and/or freeze-thaw cycles, however, the overall amount of contamination and crushing was observed to be less severe than buckling sites.
- These cores were also more intact suggesting less joint deterioration at the control sites that might be attributed to damage due to durability issues, incompressibles, or inadequate consolidation, or a combination of these factors.
- Concrete cores showed that joints are cracked and working.

Overall, the amount of incompressibles in the transverse joints at the control sites were significantly less than those at the buckling sites.

A common observation among most of the cores at the buckling sites and some of the cores at the control site were middepth horizontal cracks at or near the dowel bar depths. These cracks appear to start from the dowel bars and progress up, down, or sideways with distance from the dowel bars. Since the cores are taken six to twelve inches away from the dowel bars, they appear slightly higher or lower than the dowel bar depths.

As part of a separate project, the research team performed ultrasonic scanning of some joints near buckling site # 4 on I-39. The result of one of the scans is shown in Figure 17, which shows these cracks extending almost the full transverse width of the lane beneath the surface at approximately the depth of the dowel bar. The top red large ultrasonic echo is the delamination cracking, the two circle echoes on the top left are from two dowel bars, and the lower sporadically red and green echoes are from the boundary between the concrete and the granular base. Note that surface of the concrete is still intact. These horizontal “delamination” cracks did not always progress to the top of the pavement but when they did, they manifested themselves as large spalls at the joints. It is unclear if or how this delamination cracking is related to buckling of the pavement – i.e., if they are related, what is the mechanism, what is the cause, and what is the effect.

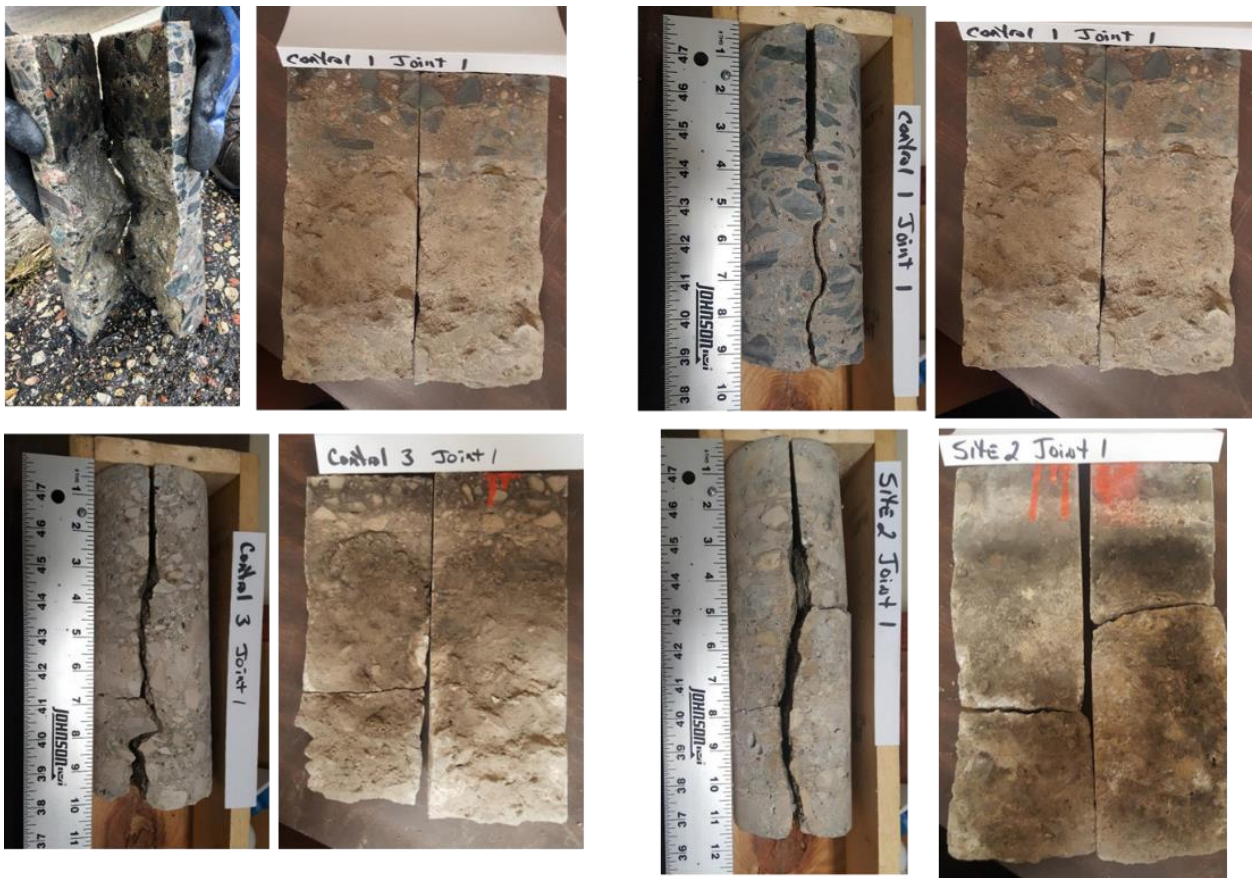




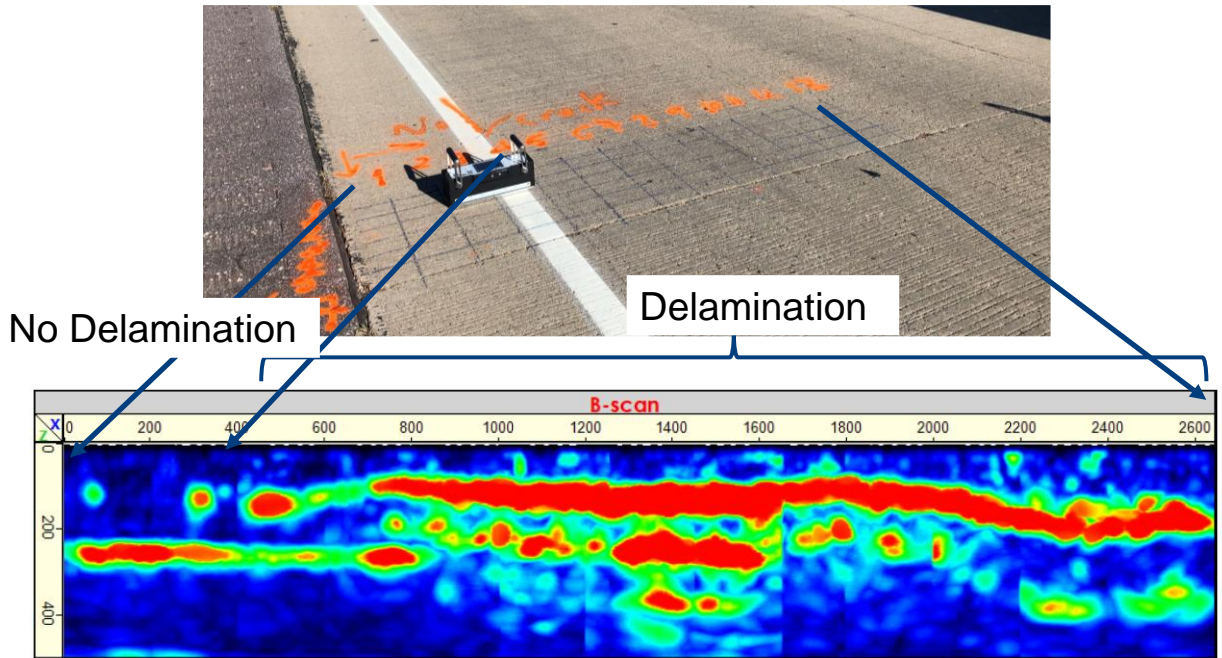
Site # 1\*

Site # 2\*

Site # 3\*



**Figure 16. Cores from control sites taken from transverse joints and core holes showing no spalls in the lower portion of the joint.**



**Figure 17. Delamination cracking beneath the surface of the concrete near Site # 4 on I-39.**

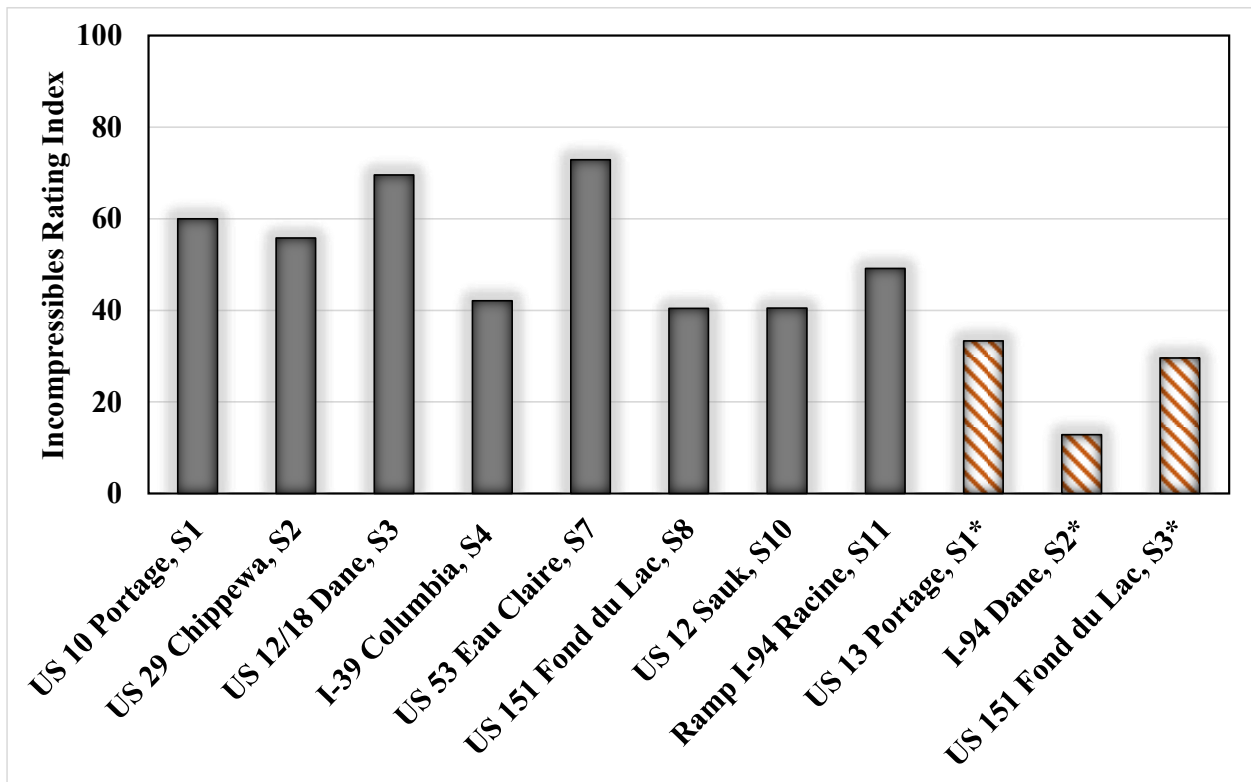
### **Incompressibles**

Incompressibles in the transverse joints were evaluated and rated based on visual observations. Joint depth and width were also measured. The site incompressibles rating index for buckling and control sites measured at a minimum of 35 joints per site is shown in Figure 18. The site incompressibles rating index is calculated by adding measured joint incompressibles rating index for all joints, divided by the total number of joints, divided by 6, and multiplying by 100. Thus, a value of 100 corresponds to all joints at the site having the maximum joint incompressibles rating index of 6. Likewise, a value of 0 corresponds to all joints at the site having the minimum joint incompressibles rating index of 0, and a value of 50 corresponds to the average incompressibles rating of 3 of the joints rated. The field observations of incompressible materials in joints include the following:

- At buckling sites, transverse joints in the traffic lanes in the vicinity of the buckling, typically contained high amount of incompressibles as compared to joints that are further from buckling locations.
- At control sites, transverse joints in the traffic lanes are mostly clear of incompressibles. These control sites are relatively younger (as compared to the buckling sites) and the amount of incompressibles in the joints are also quite uniformly distributed. There have

been no major spalls developed in the traffic lanes. It is quite likely that with age, these joints will accumulate more incompressibles contributing to spalling and/or buckling.

- A side-by-side comparison was performed between buckling and control sites located in the same county and relatively close to each other. This comparison depicting the amount of incompressibles in both sites are shown in Figure 19. The buckling sites had high amount of incompressibles and were rated as high/medium compared to the control sites.
- Incompressibles near the buckling location (red line indicating buckling location in Figure 19) are high and decreased (relatively speaking) with distance from buckling location.



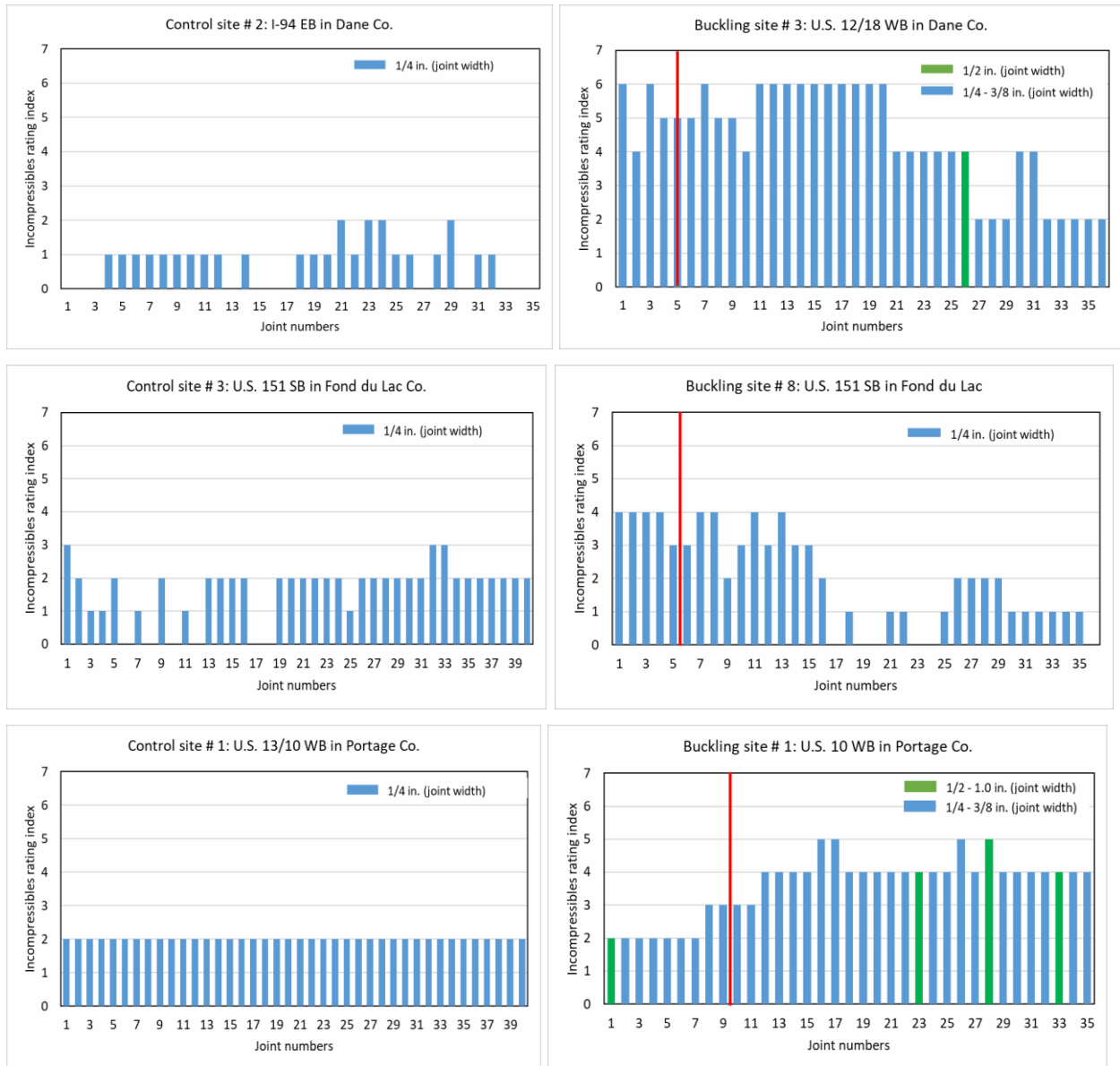
**Figure 18. Incompressible rating index for buckling and control sites.**

Incompressibles that infiltrated into joints appeared to come from many sources including:

- Adjacent areas near HMA shoulders,
- Aggregate popouts from concrete surface and tines,



- Slow-moving trucks hauling granular materials,
- Winter maintenance practices,
- Pumping from subsurface layers,
- Durability-related or movement-related spalling and crushing of the concrete.



**Figure 19. Comparison of individual joint incompressible rating indices between nearby control (left) and buckling (right) sites.**

Significant number of small pebbles and significant amount of fine-grained soil were observed on the asphalt shoulder and adjacent to buckled and/or spalled joints at multiple locations as shown in Figure 20. Some highways were located where the wind brings ample incompressibles to the surface of the pavement from adjacent areas such as shoulders and turf as shown in Figure 20.

Other sites showed clear evidence of popout of small aggregates from the concrete surface or tines as seen in Figure 21. The popouts are likely due to a combination of durability damage to the surface of the concrete from freezing/thawing of surface water, action of deicing salts, poor concrete mixture quality, and poor construction practices.

Traffic and the infiltration of precipitation through surface joints and cracks has the potential to transport these incompressibles into the joints. The opening and closing of the joints along with the action of gravity results in the finer incompressibles migrating to the lower portion of the joint (shrinkage crack joint opening). Meanwhile, the larger particles stay above the depth of the sawcut and may prop the joint open further enabling additional fines to migrate into the lower portion of the joint as shown in the core hole in Figure 22. Pumping of fine particles through joints and cracks were not noticed at either the buckling or control sites.

The number of trucks hauling fine or granular materials on buckling and control sites nor the amount and distribution of sand and grit used for winter maintenance activities were not investigated in this study. Truck hauling aggregate and winter maintenance activities may lead to an increase in the amount of incompressibles available for infiltration into the joints.

Wisconsin uses deicing/anti-icing materials such as sodium chloride, calcium chloride, magnesium chloride, sand, and sugar beet molasses to melt ice and snow accumulation and improve the friction of the pavement surface (Xiao et al. 2018). These materials can infiltrate into joints, resulting in joint and crack spalling due to durability distresses, weaker concrete, smaller cross-section area, higher amount of incompressibles from the sand and from the crushing of the concrete pieces, all of which can result in a higher risk for buckling.



Site # 7



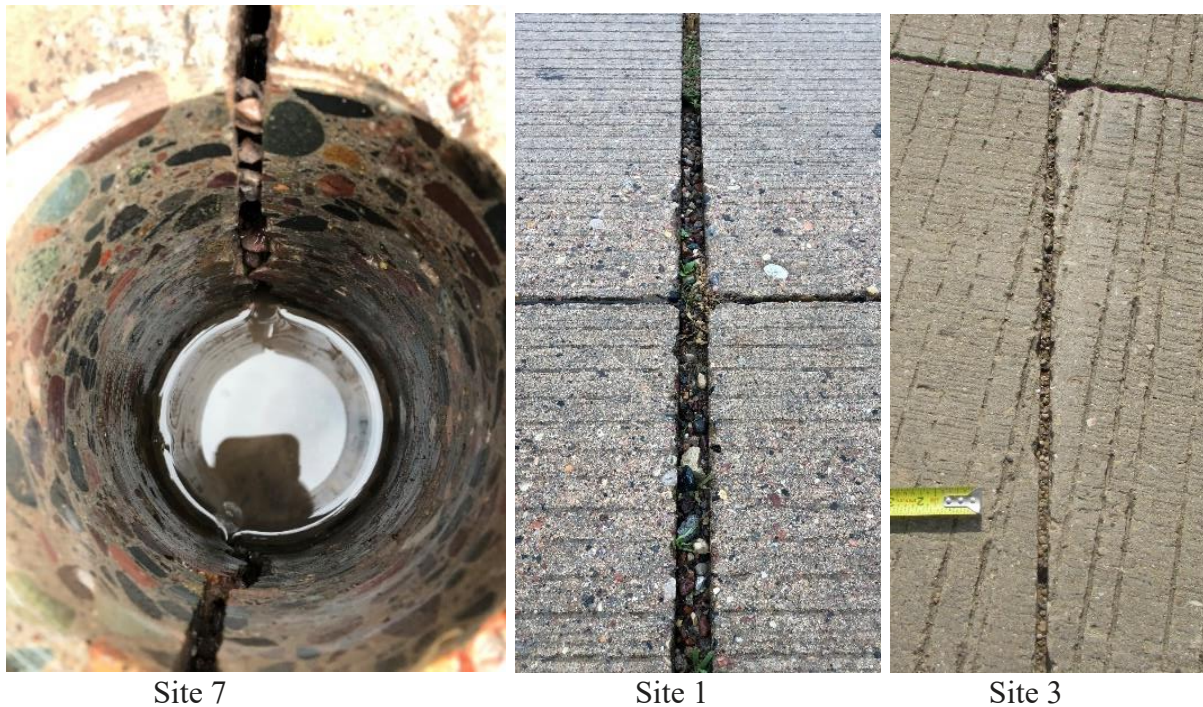
Site # 3

**Figure 20. One source of incompressibles showing small rocks, sands, and fines near buckling location.**



**Figure 21. Another source of incompressibles showing small aggregate popped out from concrete surface and transverse tines (site # 4).**





**Figure 22. Photo of incompressibles in the transverse joint.**

### **Vertical Elevation and Grade of Buckling Sites**

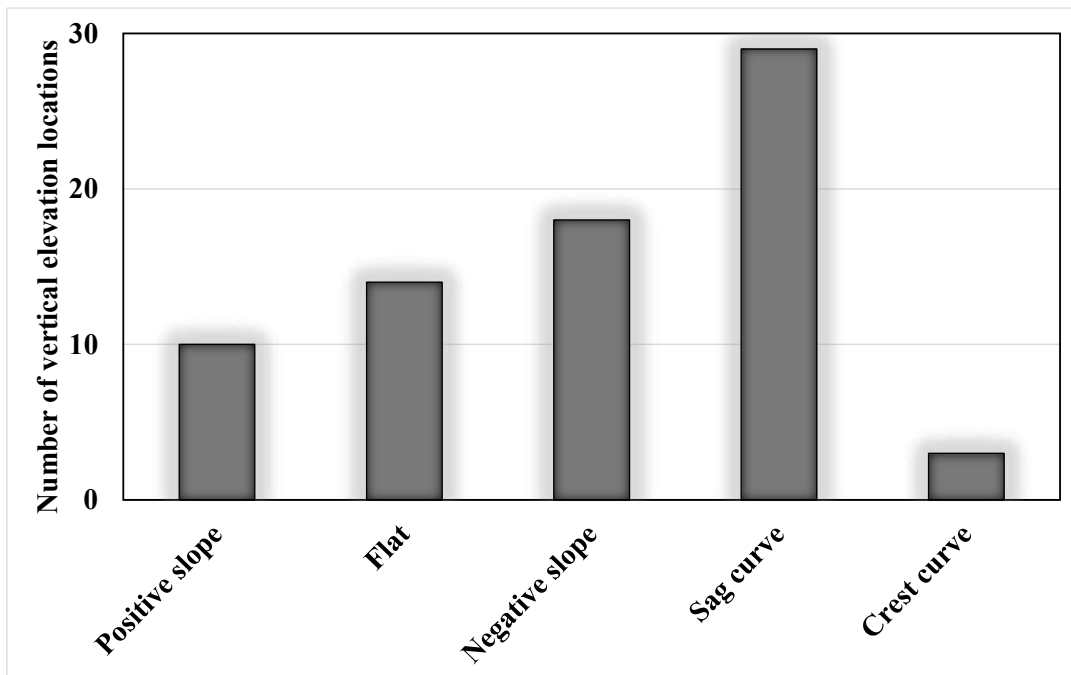
The elevation of buckling sites for the entire project comprising of the 1,000-ft. sections surveyed by the research team was estimated by using Google Earth Pro® to assess if buckling occurs at differing frequencies on sag curve, flat, or steep terrain. Table 4 shows the vertical elevation of various blowups that occurred on the different projects. Google Earth Pro provides many valuable pieces of information including vertical elevation, slope, horizontal distance, maximum/minimum and average slope and elevation. The green ellipses on the vertical elevation represent blowup locations that occurred between 2013 and 2019. The Google Earth Pro map also shows the actual blowups on the satellite image.

The number of blowups were categorized based on positive slope, negative slope, zero slope, sag curve, and crest curve as shown in Table 4 and Figure 23. This data provides an overview estimate of geometry of buckling locations that either occurred on downhill, uphill, or flat terrain. Seventy-four blowups were selected and analyzed from nine roadways located in different counties. These roadways correspond to the full construction projects of the 1,000-foot sites selected for the field survey. The summary of vertical elevation of buckling locations is as follows:

- 39.0 percent of blowups occurred on sag curve,

- 24.0 percent of blowups occurred on negative slope,
- 19.0 percent of blowups occurred on zero slope/flat,
- 14.0 percent of blowups occurred on positive slope,
- 4.0 percent of blowups occurred on crest curve.

Most of the blowups occurred on sag curves and negative slopes. This could potentially be attributed to the fact that the transverse joints at the sag curves and negative slopes deteriorate at higher rate at the surface of the joint or in the lower portion of the joint likely due to higher rates of moisture- or durability damage. It could also reflect the impact of gravity or vehicle tire-pavement interactions on the displacement (slipping) of the slabs over the base, and thus the opening and closing of joints and cracks.

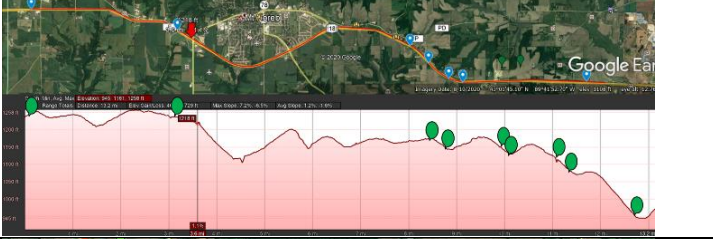
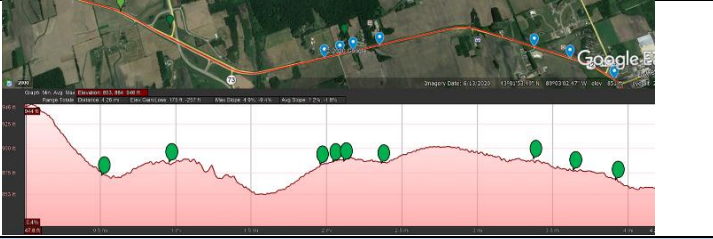


**Figure 23. Number of vertical elevation locations representing 74 buckling locations.**

**Table 4. Vertical elevation of buckling locations.**

Location	Vertical Elevation of Buckling Sites	Geometry				
		+	0/flat	-	Sag	Crest
US 10 Portage Co., Site # 1		0	5	4	3	0
US 29 Chippewa Co., Site # 2		0	2	2	4	1
US 12/18 Dane, Site # 3		2	0	4	5	0
I-39 Columbia Co., Site # 4		1	3	1	5	2
US 53 Eau Claire Co., Site # 7		2	0	0	1	0
US 151 Fond du Lac Co., Site # 8		1	1	1	3	0
US 12 Sauk Co., Site # 10		2	1	0	2	0



US 151 and N RD at MP 72, Dane Co.		1	1	2	3	0
US 12/18 and Clear View Rd, Dane Co.		1	1	4	3	0
The total number of the vertical elevation of buckling locations		10	14	18	29	3

Note: “+” positive slope, “-” negative slope, “0” zero slope/flat

### Coefficient of Thermal Expansion (CTE)

Table 5 shows the CTE of concrete mixtures made with different types of aggregates. The table shows that among the types of coarse aggregate used, concrete made with quartzite has the highest CTE value of 6.8 microstrain/°F, followed by dolomite and gravel. The concrete mixtures made with diabase, basalt, and granite showed the lowest and nearly the same value of CTE, ranging from 5.2 to 5.3 microstrain/°F. These results indicate that up to 25 percent variation in CTE of concrete is possible because of the variation in the types of aggregate.

Quartzite aggregate was used for the concrete at the U.S. 12 EB section in Sauk County, site # 10, which may have played a role in the occurrence of blowups. Concrete coring at this site showed that the lower portion of the transverse joint exhibited high amount of deterioration and spalling, and the base course materials was washed out underneath the joint. An important caveat to the discussion on CTE is that blowups commonly occur throughout Wisconsin on a range of concrete pavements constructed with different types of coarse aggregates in the concrete. For example, Eau Claire County uses limestone as the primary aggregate type, limestone is typically used in southern Wisconsin, and igneous gravel is typically used in northern Wisconsin.

**Table 5. Coefficient of thermal expansion of concrete mixtures made with different coarse aggregates (Naik et al. 2011).**

Concrete made with	28-day CTE (microstrain/°F)
Quartzite	6.8
Gravel	5.6
Dolomite	5.7
Granite	5.3
Diabase	5.2
Basalt	5.2

### **Subsurface Drainage**

Field investigations were conducted on the buckling and control sites to evaluate the drainage outlet conditions. Only two buckling sites were constructed using subsurface drainage systems. The condition of the outlet pipes was evaluated and there were no indications of blocking or clogging in the outlet pipes as shown in Figure 24. Blowups occurred on both JPCP with and without subsurface drainage system. As such, the evaluation of subsurface drainage in terms of buckling performance was inconclusive.

A caveat to the inconclusive field observations and impact of subsurface drainage and moisture is based on anecdotal evidence from interviews with WisDOT personnel. A county engineer from Portage County (U.S. 10 WB site #2) said that they found water when they removed the shattered concrete slabs to fix the blowups. Likewise, maintenance personnel from Sauk County (U.S. 12 EB site #10) mentioned that when they removed a slab that was buckled, they noticed a lot of moisture/water trapped underneath the slab.

Water trapped near joints is a major contributor to durability-distresses, both freeze thaw damage, and deicing salt damage, in concrete. Two main factors resulting in trapped water near joints are the lack of proper sealant (or a failed sealant) and poor drainage of subsurface layers. While sealed or filled joints do not eliminate water from entering the joints, they do play a role in reducing the amount of water entering the joints. Pavements that are subjected to longer saturation periods, concretes with marginal air void systems, and high usage of deicing salts, contribute to concrete deterioration. These types of deterioration progress rapidly once the damage starts (Taylor 2011). Zhang et al. (2015) reported that in JPCP, low permeability in base layers beneath the pavements correlates with joint deterioration.

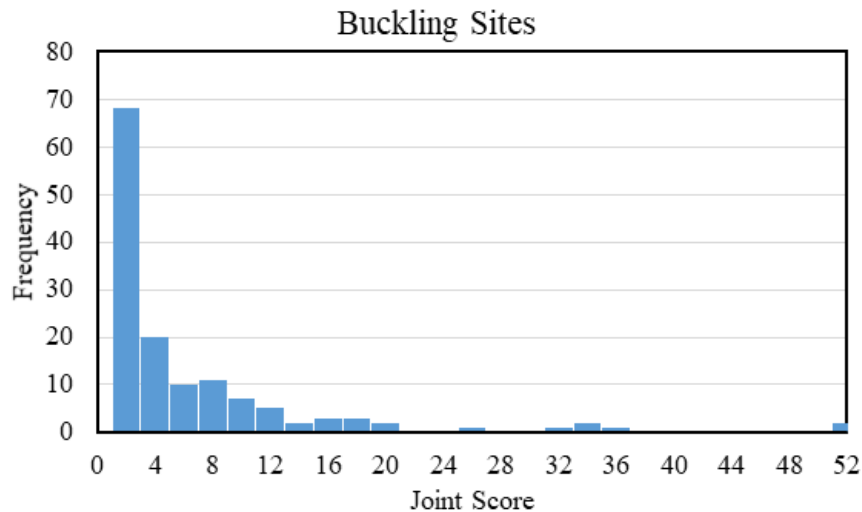


U.S. 29 WB in Chippewa Co., Site # 3 (left), I-39 SB in Columbia Co., site # 4 (right)

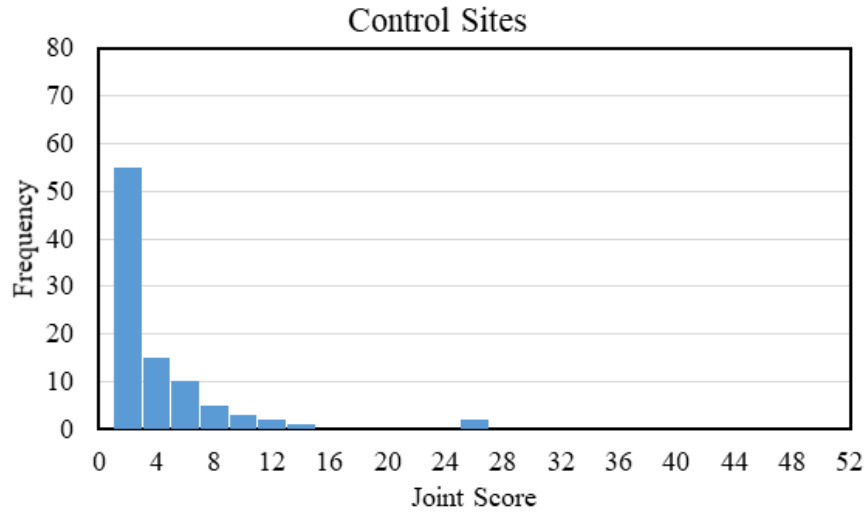
**Figure 24. Edge drainage showing no clogging.**

### Dowel Alignment

Pulse induction technology scanning was performed on buckling and control sites by WisDOT to evaluate the impact of dowel bar alignment on the occurrence of blowups. Joint scores were calculated for buckling and control sites as shown in Figure 25 and Figure 26. Over 95 percent of the dowels at both buckling sites and control sites had joint score less than 10 and only a few joints had joint score greater than 30. The results indicated that dowel bar alignment in Wisconsin (within the typical ranges of misalignment) had no impact on joint locking or buckling.



**Figure 25. Joint scores of buckling sites.**



**Figure 26. Joint scores of control sites.**

### Data Analysis

Simple statistical analyses were conducted on the field data to investigate the impact of various parameters including incompressibles, asphalt patches, spalls, joint spacing, and PCC thickness on blowups. The total number of blowups per mile between 2013 and 2020, amount of incompressibles (incompressibles rating index), number of spalls and asphalt patches, joint spacing, and PCC thickness for each site is shown in Table 6.

**Table 6. Field data collected from buckling and control sites.**

Site number	Blowups per mile*	Incompressibles rating index	No. of spalls and asphalt patches	Joint spacing	PCC thickness
Buckling site # 1	1.08	60.0	1.0	15.0	10.0
Buckling site # 2	1.00	59.0	10.0	18.0	10.0
Buckling site # 3	2.44	74.8	7.0	15.0	9.5
Buckling site # 4	1.64	42.4	4.0	18.0	10.0
Buckling site # 7	1.27	78.6	11.0	15.0	9.5
Buckling site # 8	0.83	41.4	3.0	15.0	10.0
Buckling site # 10	0.86	40.5	4.0	15.0	10.0
Control site # 1*	0.12	33.3	0.0	15.0	10.0
Control site # 2*	0.00	12.9	0.0	15.0	11.5
Control site # 3*	0.46	29.0	0.0	15.0	10.0

\* Over an 8-year period (2013 to 2020).

A regression model was attempted to correlate the independent variables with the number of blowups per mile. However, due to the large number of variables relative to the number of field sections, this model was statistically insignificant at a 95 percent confidence level.

Pearson’s correlation coefficient between all variables was estimated to quantify the correlation between the dependent variable and other independent variables, and the multicollinearity between the independent variables. Table 7 presents the Pearson’s correlation coefficients in a correlation matrix. The data indicates a strong correlation between incompressibles and the number of spalls and asphalt patches and between incompressibles and number of blowups. This strong multicollinearity leads to unreliable estimates of significant regression parameters when incorporating these two variables in one multiple linear regression model given the limited amount of data (field sections). As such, a multivariate regression model was not developed using the field data, but rather three individual regression models are presented below.

**Table 7. Correlation coefficient between variables.**

	<b>Blowups per mile</b>	<b>Incompressibles rating index</b>	<b>Number of spalls and asphalt patches</b>	<b>Joint spacing</b>	<b>PCC thickness</b>
<b>Blowups per mile</b>	1.00				
<b>Incompressibles rating index</b>	0.78	1.00			
<b>Number of spalls and HMA patches</b>	0.59	0.79	1.00		
<b>Joint spacing</b>	0.26	0.09	0.38	1.00	
<b>PCC thickness</b>	-0.66	-0.79	-0.54	-0.05	1.00

A simple linear regression model was developed to correlate the number of spalls and asphalt patches with the amount of incompressibles in the transverse joints (Figure 27). A strong correlation between the incompressibles rating index (i.e., independent variable) and the number of spalls and asphalt patches (i.e., dependent variable) was observed. The results of the regression model indicated that the model has a coefficient of determination ( $R^2$ ) of 0.63, which means that 63 percent of the variance in the number of spalls and asphalt patches can be related to the change in the incompressibles rating index. Moreover, the model was significant at p-value of 0.0063 at 95 percent confidence level.

A simple linear regression model was developed to correlate the number of blowups per mile with the amount of incompressibles in the transverse joints (Figure 28). A strong correlation between the incompressibles rating index (i.e., independent variable) and the number of blowups per mile (i.e., dependent variable) was observed. The results of the regression model indicated that the model has a coefficient of determination ( $R^2$ ) of 0.61, which means that 61 percent of the



variance in the number of blowups per mile can be related to the change in the incompressibles rating index. Moreover, the model was significant at p-value of 0.0080 at 95 percent confidence level.

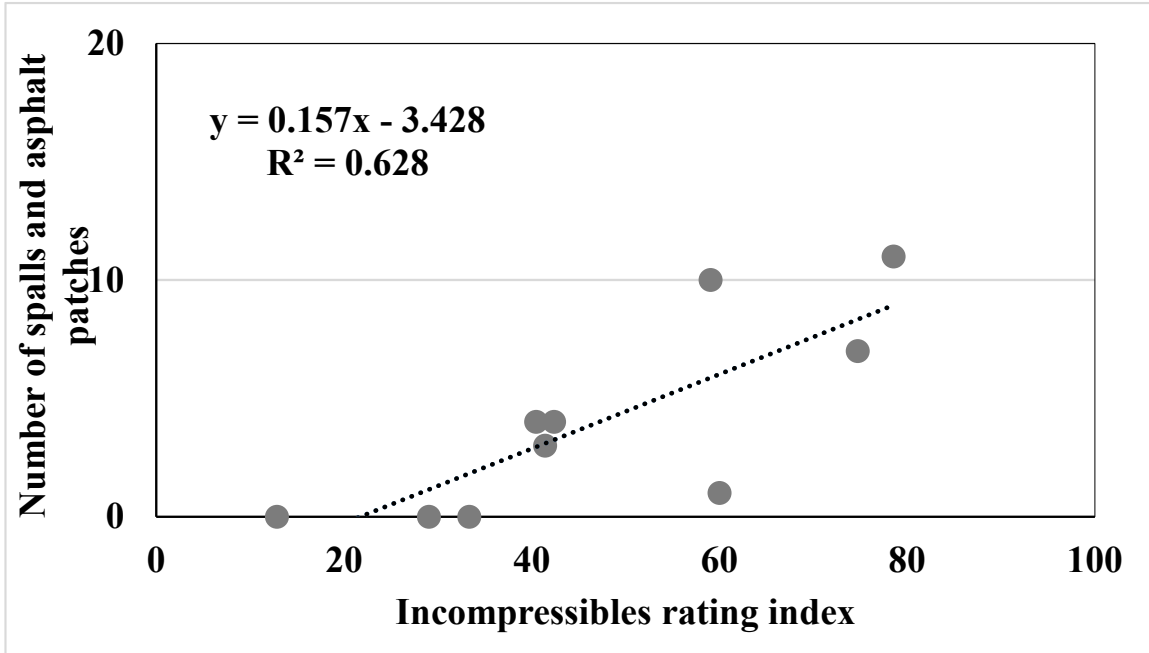


Figure 27. Number of spalls and asphalt patches vs. incompressibles rating index.

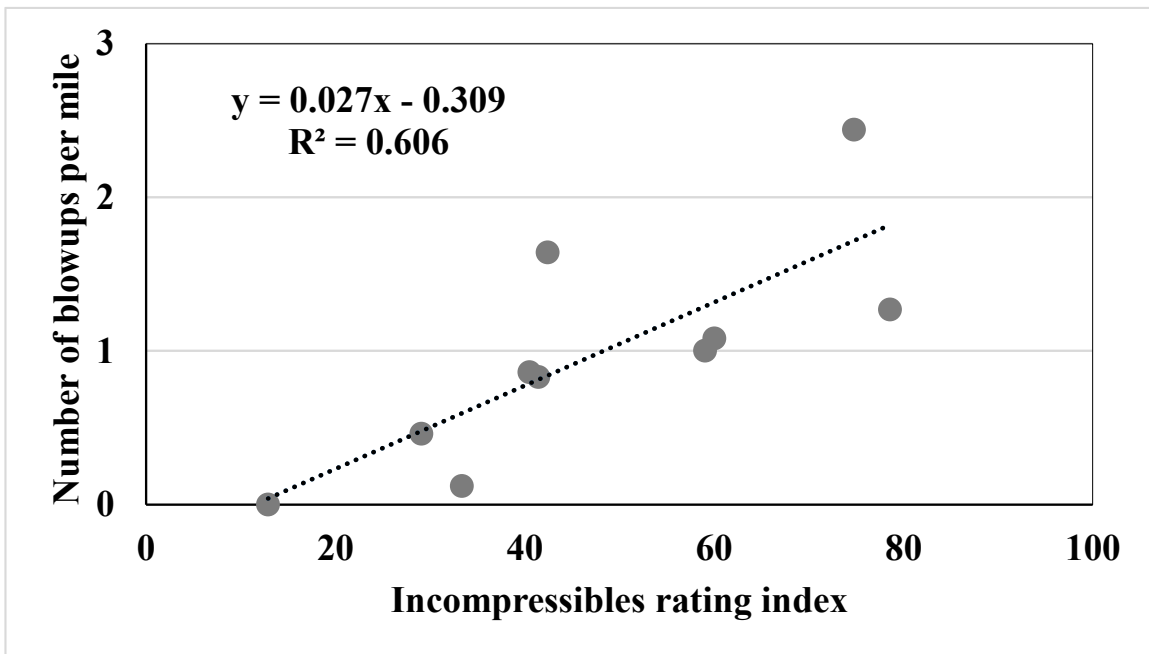


Figure 28. Number of blowups per mile vs. incompressibles rating index.

A simple linear regression model was developed to correlate the number of blowups per mile with the number of spalls and asphalt patches. This model shows that the impact of the number of spalls and asphalt patches was less than of incompressibles on the occurrence of blowups. The model has an  $R^2$  of 0.35 and is less significant as compared to incompressibles, with a p-value of 0.07 at 95 percent confidence level. Other independent variables (joint spacing and PCC thickness) did not show strong correlation with the number of blowups per mile. This may be attributed due to the relatively small ranges of these variables (15 to 18 feet for joint spacing and 9.5 to 11.5 inches for PCC thickness) and the limited data set.

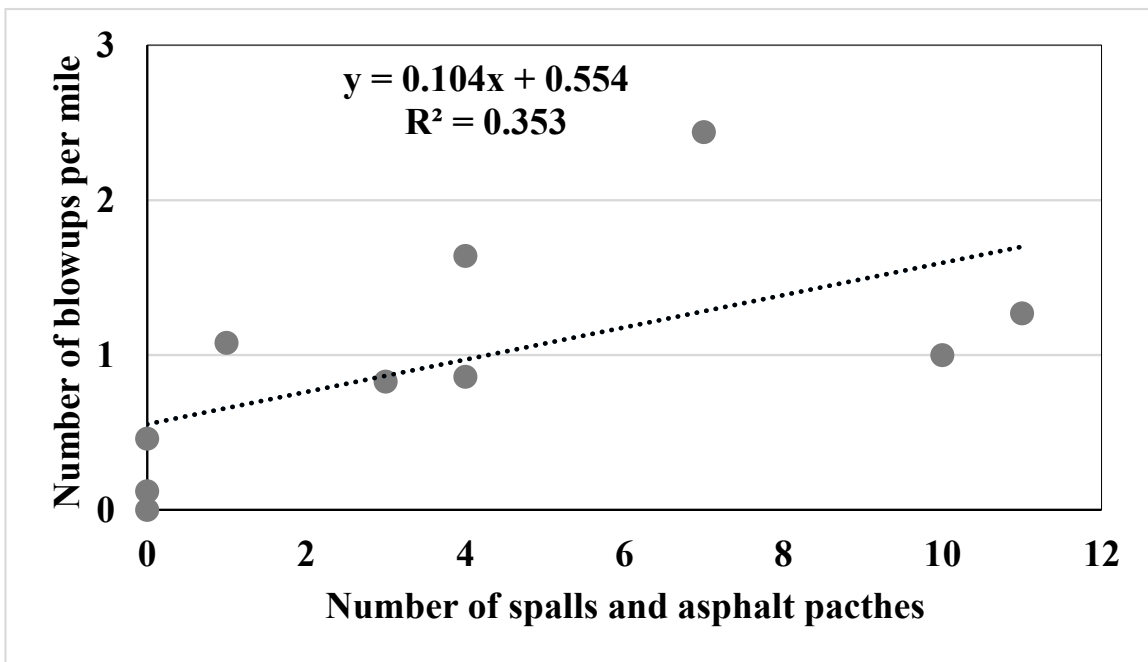
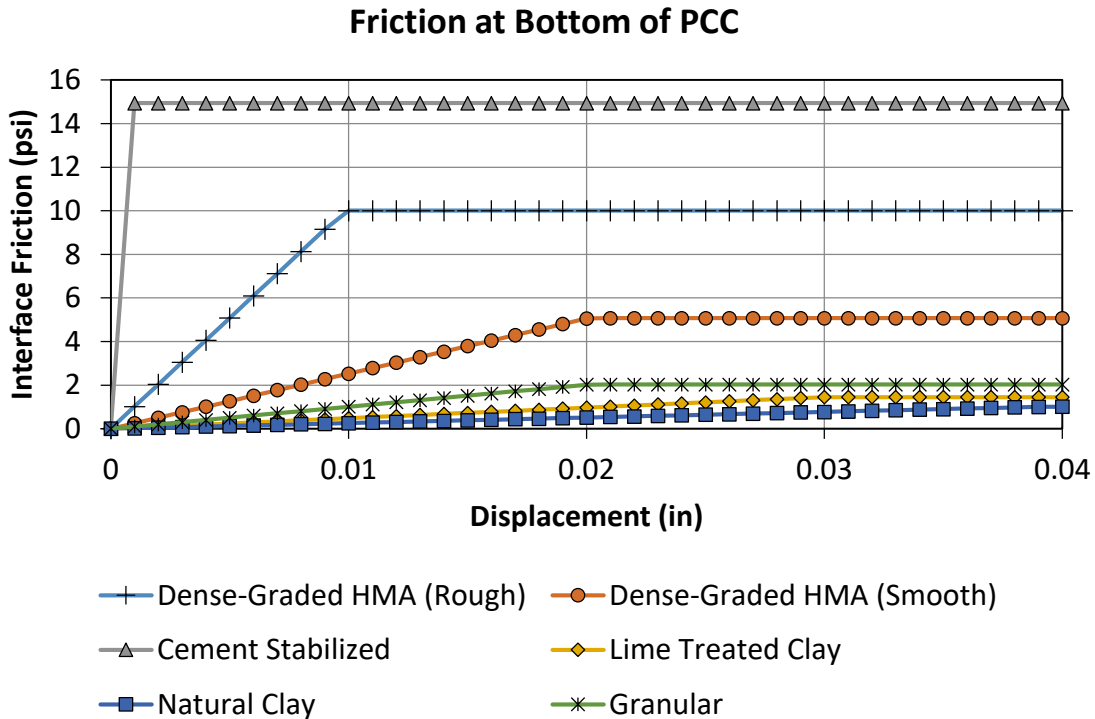


Figure 29. Number of blowups per mile vs. number of spalls and asphalt patches.

## Analytical Model

### Effect of Temperature

Figure 30 shows the bilinear model of friction at the bottom of PCC layer for different foundation types (Roesler and Wang 2011). The bilinear friction model was consistently used in both the analytical model for joint opening/closing and buckling.



**Figure 30. Friction at PCC slab and base interface.**

Among the various interface friction models shown above, those corresponding to Granular Base (GB) and Cement Stabilized Base (CSB) were used for a Monte-Carlo (MC) simulation. Table 8 shows the list of relevant inputs along with their mean values used in the MC analysis. The table also shows the Coefficient of Variation (COV) assigned to each variable for MC analysis.

The procedure for MC simulation is described in the following.

1. Using a random number generator, obtain a set of inputs (for those listed in Table 8) corresponding to their respective mean and COV (or standard deviation).
2. Calculate the maximum available joint opening due to drying shrinkage of the PCC slabs (and at the neutral temperature of PCC), using the following ACI equation.

$$\varepsilon_{dry}(t) = \frac{t}{35+t} \varepsilon_{su} \quad (1)$$

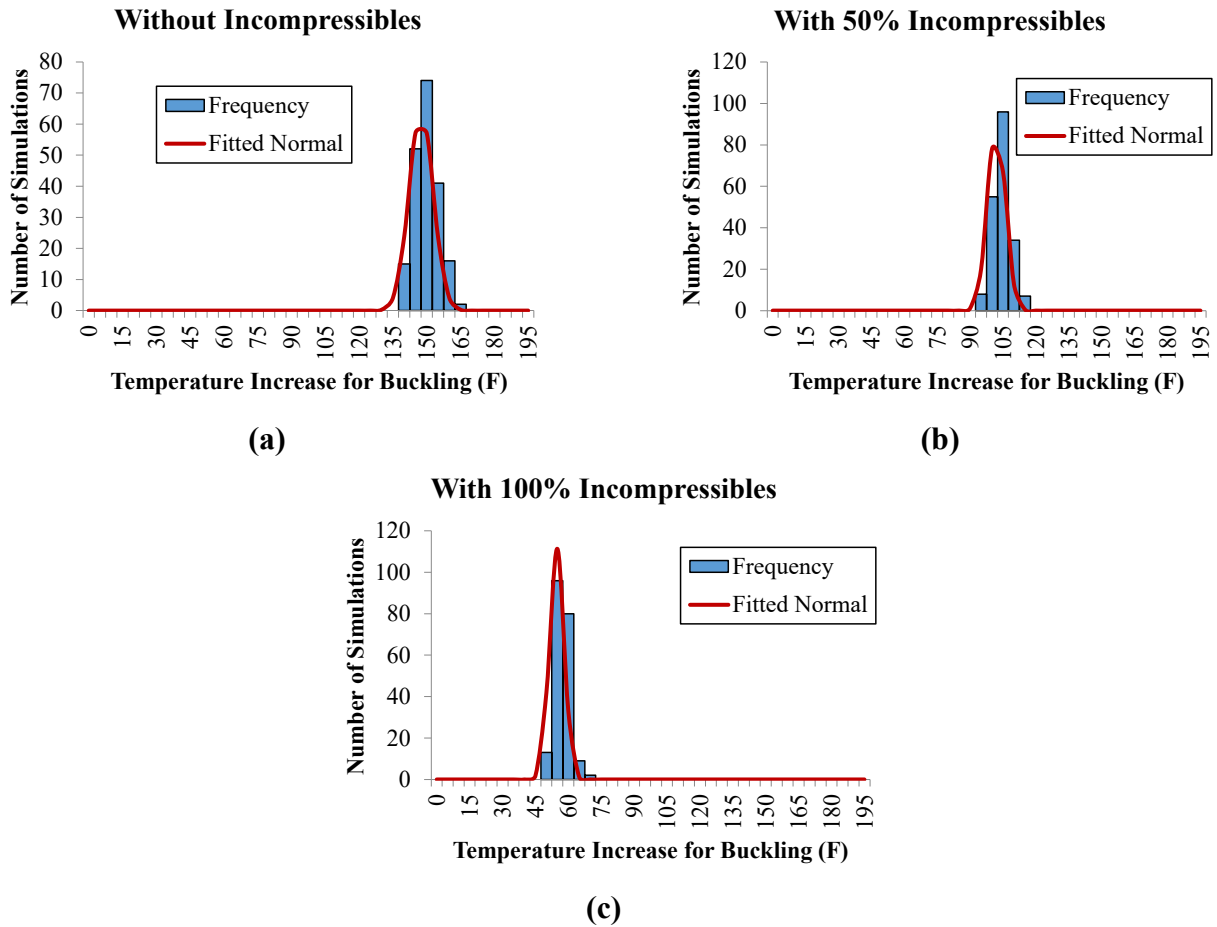
where  $\varepsilon_{dry}$  is the uniform drying shrinkage through the thickness of the PCC slab at time  $t$  (in days) and  $\varepsilon_{su}$  is the ultimate drying shrinkage strain value. Since most of the PCC drying shrinkage occurs within the first 2 to 3 months of placement, a constant time value of 90 days was consistently used for the MC simulation.

3. Calculate the equivalent temperature increase (i.e., combined effect of temperature and moisture) needed to fully close the joint using the analytical model developed by Roesler and Wang (2011). The temperature required to fully close the joint is calculated for different amounts of incompressible materials within the joint. Since there is no clear relationship between the amount of incompressibles and the available joint opening, it was simply assumed that the available joint opening is reduced by the percentage of incompressibles within the joint. As an example, 25 percent incompressible materials will cause a 25 percent reduction in maximum available joint opening, thereby only 75 percent of the maximum joint opening is available for slab expansion.
4. Calculate additional temperature increase that will cause PCC slabs to buckle, using the analytical model developed by Kerr and Dallis (1985).
5. Obtain the equivalent temperature increase needed for buckling as the sum of temperature increases obtained in Steps 3 and 4. This is the temperature increase needed to fully close the joint and to develop build-up of compressive stresses within the PCC that will ultimately lead to buckling.
6. Repeat Steps 1 through 5 to obtain a distribution of temperature increase needed for buckling.

Figure 31 shows an example of the buckling temperature (i.e., increase in temperature from the neutral temperature of PCC) distributions for the PCC slabs on GB having 0 percent, 50 percent, and 100 percent incompressible materials within the joint. The figure clearly indicates that the more the amount of incompressibles, the lower the temperature at which buckling occurs, and higher the overall probability of buckling at any given temperature.

**Table 8. Inputs for Monte-Carlo simulation of buckling.**

Input	Variable	Value	Unit	Variability (COV, percent)
Structural	Joint Spacing	15	Ft	0
Concrete	Elastic Modulus, $E$	$5.0 \times 10^6$	Psi	10
	Thickness, $h$	10	Inch	5
	Poisson's Ratio, $\nu$	0.2	Dimensionless	0
	CTE, $\alpha$	$5.5 \times 10^{-6}$	Strain/°F	2
	Unit Weight, $\gamma$	145	pcf	1
Concrete/Base Interface Shear (GB)	Steady-State Friction, $\tau_o$	2.03	psi	0
	Slippage, $\delta_o$	0.020	inch	0
Concrete/Base Interface Shear (CSB)	Steady-State Friction, $\tau_o$	14.9	psi	0
	Slippage, $\delta_o$	0.001	inch	0



**Figure 31. Equivalent temperature increase needed for buckling with (a) 0 percent, (b) 50 percent, and (c) 100 percent incompressible materials within the joint (granular base).**

## Equivalent Temperature due to Moisture and Humidity

In the previous section, a probabilistic analysis approach was presented for estimating the temperature increase (from the neutral temperature of PCC) needed for a slab to buckle.

However, moisture within the PCC slab also contributes to contraction and expansion.

Therefore, the temperature increase presented in the previous section should be an “Equivalent Temperature Increase” which incorporates the combined effect of temperature and moisture.

The primary source of PCC contraction is drying shrinkage which develops over time when the PCC is placed and subjected to drying. When such PCC material is wetted again, a portion of the drying shrinkage is reversed and causes the PCC slab to expand. According to Lederle and Hiller (2012), the amount of reversible shrinkage strain can be estimated by the following equation.

$$\varepsilon_r = \phi \cdot \varepsilon_{su} \cdot (S_{h,i} - S_{h,ave}) \quad (2)$$

where,

- $\phi$  = Reversible shrinkage factor (i.e., fraction of total shrinkage that is reversible).  
Typical value equals 0.5.
- $\varepsilon_{su}$  = Ultimate shrinkage strain
- $S_{h,i}$  = Relative humidity factor for a given month  $i$  ( $S_{h,i} = 1.1$  for  $RH < 30\%$ ,  $S_{h,i} = 1.4 - 0.01 \cdot RH$  for  $30\% < RH < 80\%$ ,  $S_{h,i} = 3.0 - 0.03 \cdot RH$  for  $RH > 80\%$ ),
- $S_{h,ave}$  = Annual average relative humidity factor (i.e., annual average of  $S_{h,i}$ ),
- $RH$  = Ambient relative humidity

With a crude assumption that the reversible shrinkage strain in Equation (2) occurs uniformly through the thickness of the PCC slab, the equivalent temperature increase can simply be obtained by equating the strain due to a uniform temperature increase (i.e.,  $\varepsilon = \alpha \cdot \Delta T$ ) to the reversible strain in Equation (2). The resulting equation is obtained as the following.

$$\Delta T_{Equivalent} = \frac{\varepsilon_r}{\alpha} = \frac{\phi \cdot \varepsilon_{su}}{\alpha} \cdot (S_{h,i} - S_{h,ave}) \quad (3)$$

It should be noted that the reversible shrinkage strain in Equation (2) is calculated based on the premise that the ambient relative humidity ( $RH$ ) is the main factor responsible for reversible shrinkage within a hardened PCC at any given time. The same premise was also used in the moisture warping model adopted in the Mechanistic-Empirical Design Guide (MEPDG)

(Yu et. al, 2004). More specifically, the MEPDG warping model converts the differential shrinkage (through the thickness of PCC) into an Equivalent Temperature Gradient (ETG) by equating the stress due to the moment caused by the reversal shrinkage (Equation (2)) within the top shrinkage zone (typically assumed to be within the top 2 inches of PCC) equal to the stress due to an equivalent linear temperature distribution (Lederle and Hiller, 2012).

It is also worth mentioning that in the previous section, the ultimate shrinkage strain,  $\varepsilon_{su}$ , was assumed to be an independent variable with a mean of 800 microstrain and a COV of 10 percent. However, the MEPDG warping model treats  $\varepsilon_{su}$  as a dependent variable predicted from the RILEM equation given as the following (RILEM, 1995).

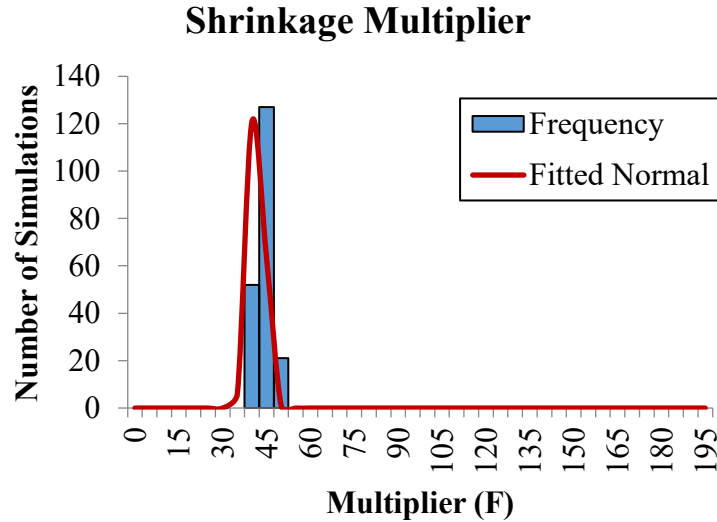
$$\varepsilon_{su} = C_1 \cdot C_2 \cdot \left( 26w^{2.1} \left( f_c' \right)^{-0.28} + 270 \right) \quad (4)$$

where,

- $C_1$  = Cement type factor (1.0 for Type I, 0.85 for Type II, and 1.1 for Type III cement)
- $C_2$  = Curing type factor (1.0 for moist curing; 1.2 if cured using a curing compound)
- $w$  = Water content (lb/ft<sup>3</sup>)
- $f_c'$  = 28-day PCC compressive strength (psi)

The significance of Equation (3) and Equation (4) is that the equivalent temperature increases due to moisture,  $\Delta T_{Equivalent}$ , would also result in a distribution from the MC simulation. The random (but normally distributed) MC variables affecting the distribution of  $\Delta T_{Equivalent}$  were assumed to be the PCC coefficient of thermal expansion ( $\alpha$ ), water content ( $w$ ), and compressive strength ( $f_c'$ ). Therefore, these independent variables were treated as normally distributed MC inputs in the subsequent analyses. Note that Equation (4) was used not only for determining the equivalent temperature increase due to moisture (Equation (3)), but also in the analytical buckling model presented previously (Equation (1)).

By defining the “Shrinkage Multiplier” as  $\phi \cdot \varepsilon_{su} / \alpha$  (i.e., the term including MC variables in the right-hand-side of Equation (3)) and its distribution determined from the MC simulation, the distribution of  $\Delta T_{Equivalent}$  can be easily obtained for any given relative humidity (or the relative humidity factor). Figure 32 shows an example of the shrinkage multiplier distribution obtained by assigning a previously specified COV to all the associated MC variables.



**Figure 32. Distribution of shrinkage multiplier.**

#### Application to Field Data

In this section of the report, the probability of buckling is assessed on two of the field sites (one control and one buckled section) based on the MC models developed previously. However, it should be noted that due to the challenges associated with assessing the amount of incompressibles in the field, it was assumed that the joint capacity to open and close due to the presence of incompressibles (percent incompressibles) followed a normal distribution. The mean and standard deviation of the normal distribution were assumed to increase linearly with pavement age, such that a mean of 50 percent and a standard deviation of 15 percent were reached at pavement age of 10 years. In other words, the percent incompressible was included in the MC simulation as an additional independent variable.

The probability of buckling is assessed by comparing two temperature components (or distributions) described in the following:

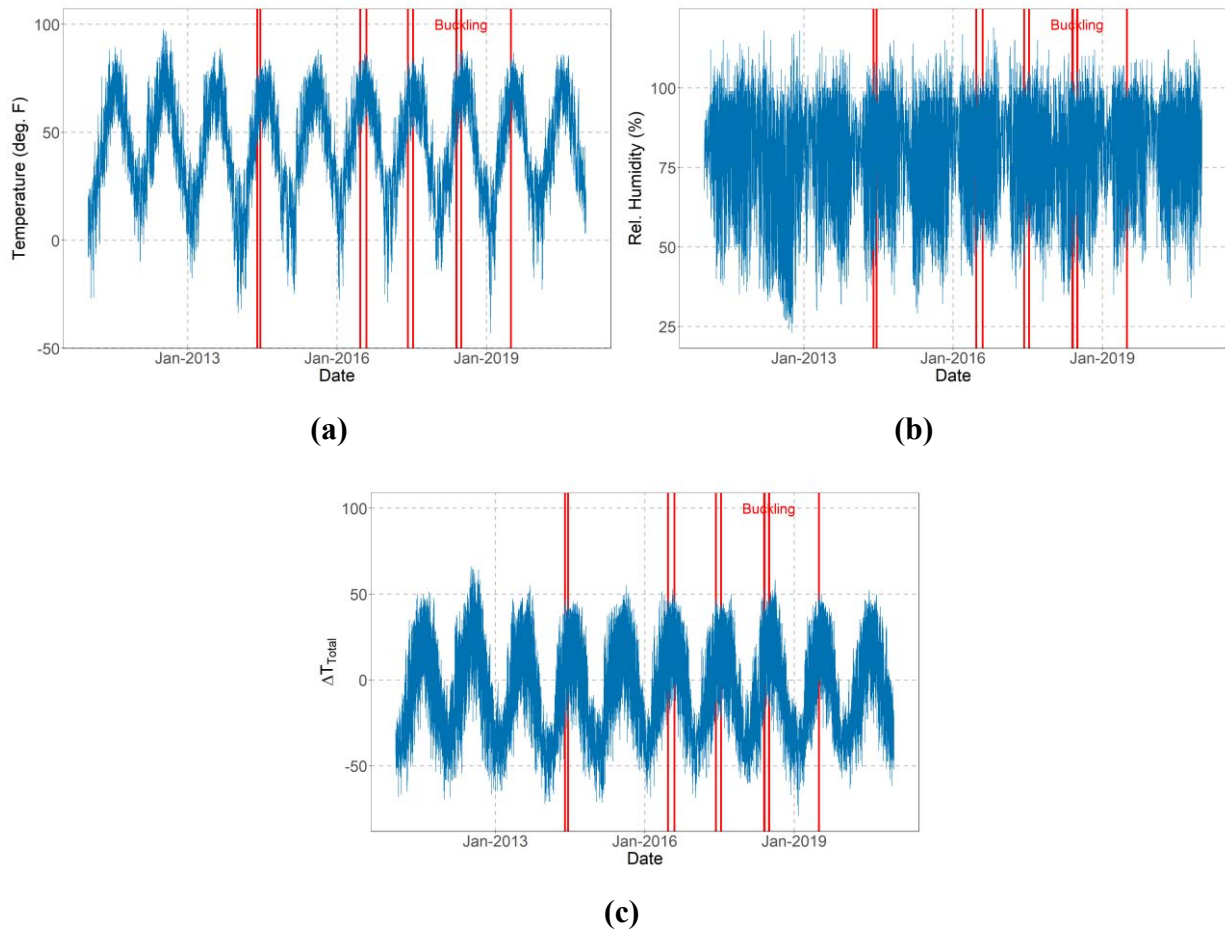
1. Equivalent temperature increase required for buckling,  $\Delta T_B$ , i.e., the minimum temperature needed to fully close the joint and buckling to occur. The distribution of  $\Delta T_B$  is obtained from the MC simulation of the analytical models described previously.
2. Equivalent temperature increase,  $\Delta T_{Total}$ , calculated from actual climate data. It is a sum of the actual temperature increase ( $\Delta T$ ) and the equivalent temperature ( $\Delta T_{Equivalent}$ ) calculated from humidity data using Equation (3). Therefore,  $\Delta T_{Total} = \Delta T + \Delta T_{Equivalent}$ .



The distribution of  $\Delta T_{Total}$  follows the distribution of  $\Delta T_{Equivalent}$ , which is obtained from MC simulation of Equation (3).

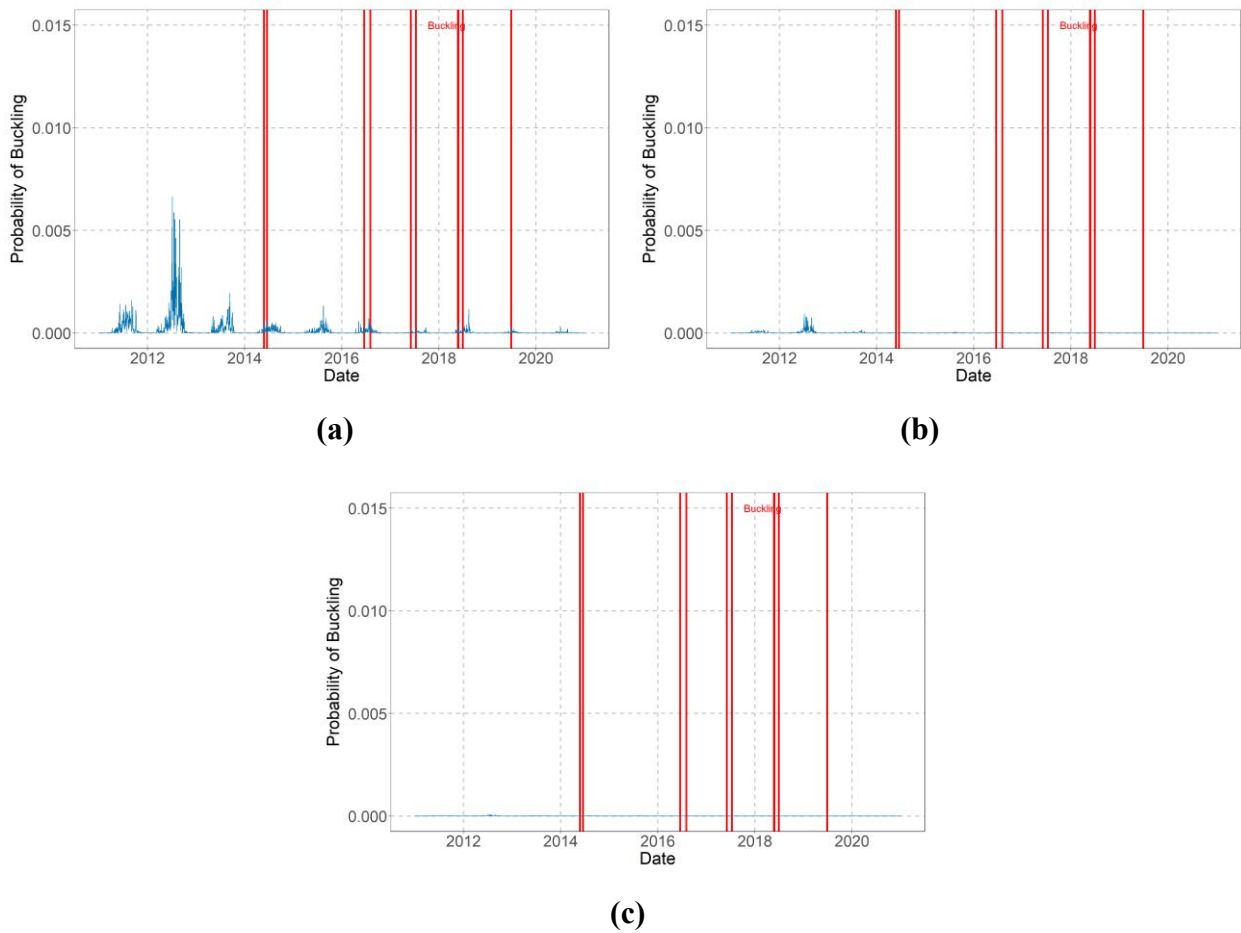
The main hypothesis is that if  $\Delta T_{Total}$  is greater than  $\Delta T_B$ , buckling may occur. Since both temperatures are obtained as a distribution, the probability of buckling is simply obtained as the probability corresponding to  $(\Delta T_{Total} - \Delta T_B) > 0$ . For the subsequent analyses,  $\Delta T_{Total}$  was calculated for every hour within the available climate data and the highest  $\Delta T_{Total}$  within each day was used for assessing the probability of buckling.

As an example, Figure 33 shows the temperature, humidity, as well as the calculated  $\Delta T_{Total}$  value for control site # 1, where the joints were relatively free of incompressible materials and no buckling was observed. The figure also shows the blowups that occurred along the same roadway within  $\pm 5.0$  miles from control site # 1, which correspond closely to the  $\Delta T_{Total}$  peaks as expected.

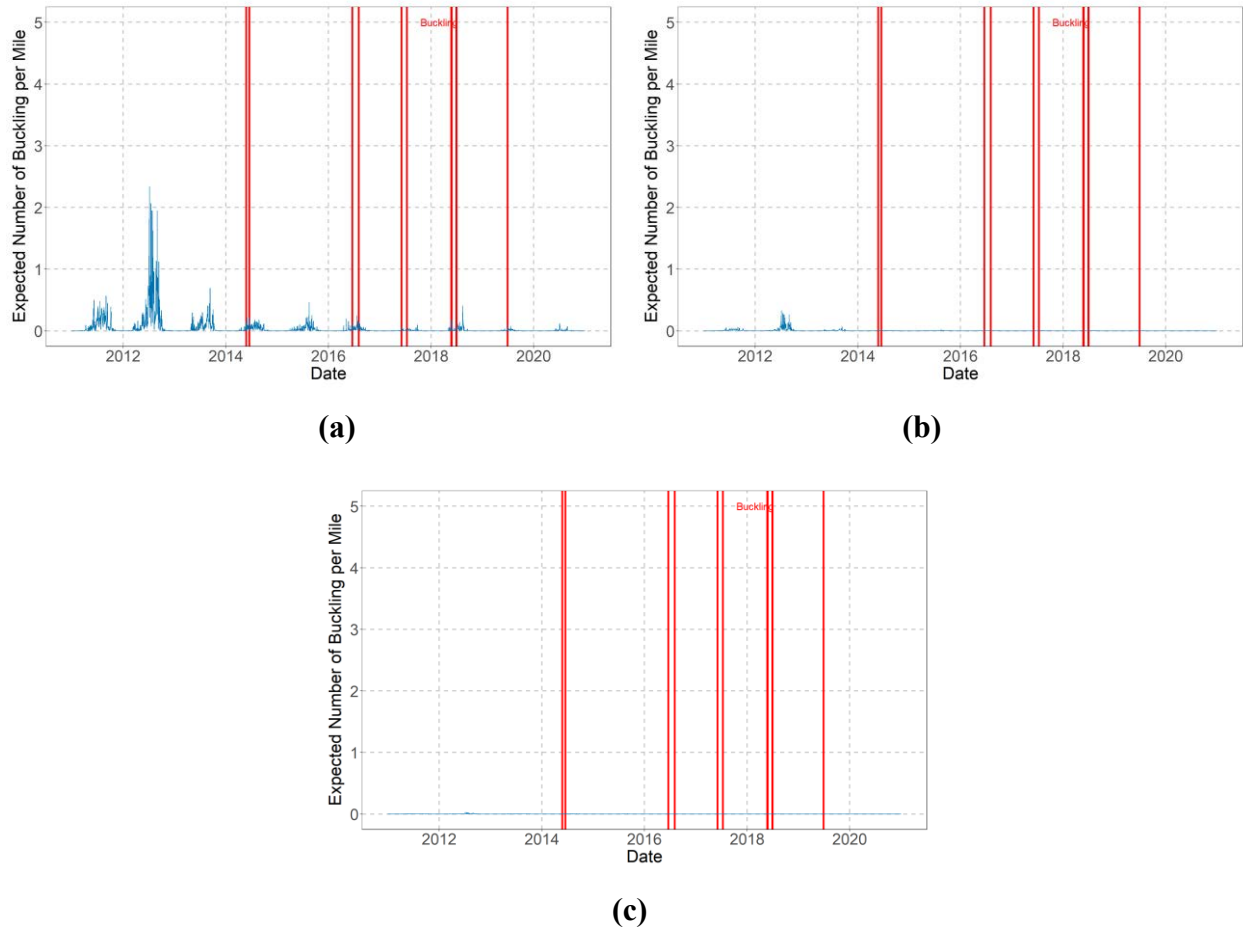


**Figure 33. Control site # 1 (a) temperature, (b) relative humidity, and (c) mean  $\Delta T_{Total}$ .**

Figure 34 shows the probability of buckling for different neutral temperatures of PCC pavement. Similarly, Figure 35 shows the expected number of joints to buckle per mile (assuming 352 total joints per mile, with 15 feet joint spacing). These figures generally show minimal probability of buckling, especially for PCC neutral temperature above 70 °F. Figure 34 and Figure 35 suggest a high probability of buckling in the summer of 2012 for the control site # 1, which corresponds to the peaks of  $\Delta T_{Total}$  in Figure 33(c), but only if the neutral temperature was not high (50 °F). However, this control site exhibited no buckling in 2012, which suggests high neutral temperatures or not enough incompressibles in the joints in 2012.

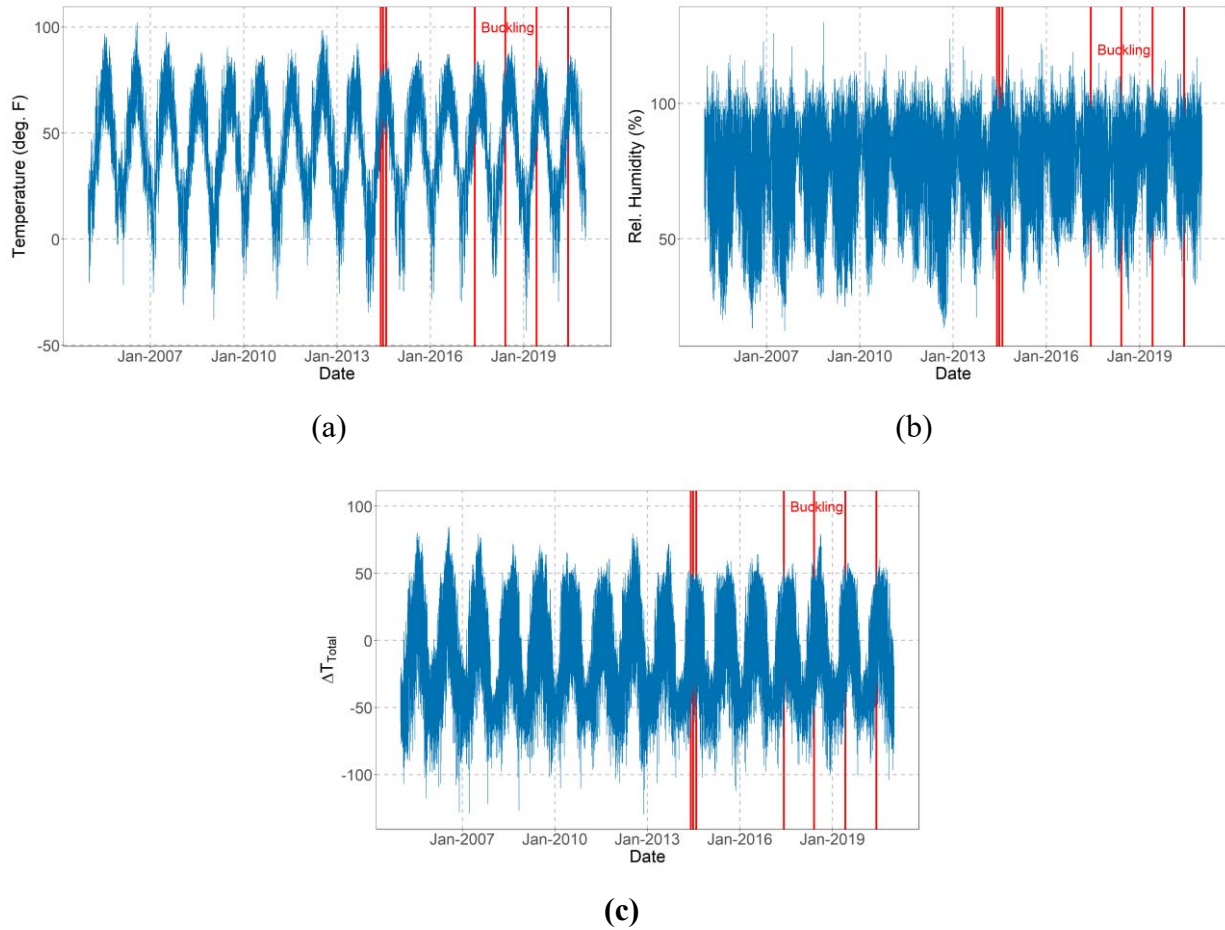


**Figure 34. Probability of buckling for control site #1 for neutral temperatures of (a) 50 °F, (b) 70 °F, and (c) 90 °F.**



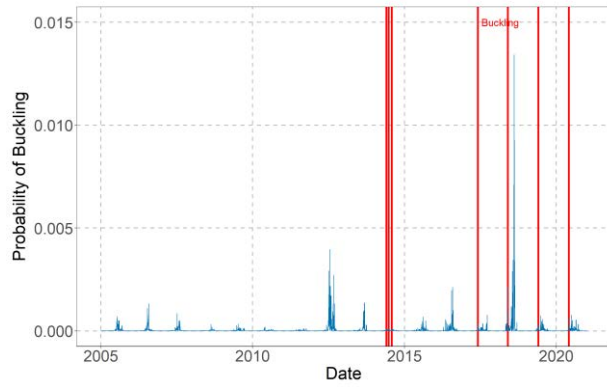
**Figure 35. Expected number of buckled joints for control site #1 for neutral temperatures of (a) 50 °F, (b) 70 °F, and (c) 90 °F.**

Similarly, Figure 36 shows the temperature, humidity as well as the calculated  $\Delta T_{Total}$  value for the buckling site # 7, where the joints were full of incompressible materials and a blowup occurred within the site in May 2019. In addition to this blowup that occurred within the site in May 2019, the figure also shows the blowups that occurred along the same roadway within  $\pm 5.0$  miles from site # 7. Note that many blowups took place in the summer of 2014.

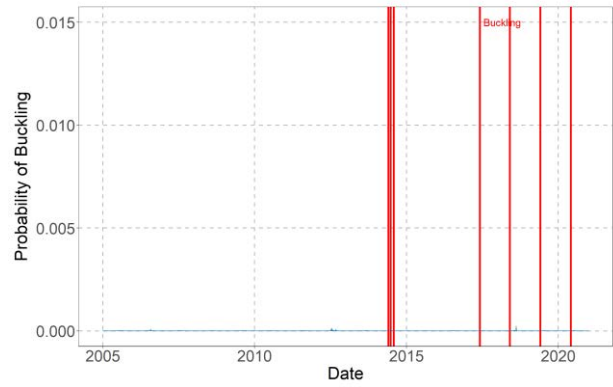


**Figure 36. Buckling site #7 (a) temperature, (b) relative humidity, and (c) mean  $\Delta T_{Total}$ .**

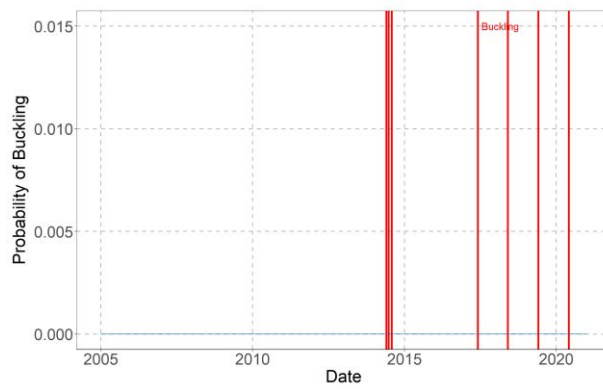
Figure 37 shows the site #7 probability of buckling for different neutral temperatures of PCC pavement, while Figure 38 shows the expected number of joints to buckle per mile. Similar to the control site previously presented, the figure shows minimal probability of buckling for neutral temperatures above 70 °F, but the probability is higher for the neutral temperature of 50 °F as compared to the control section, particularly between the years 2015 and 2020.



(a)

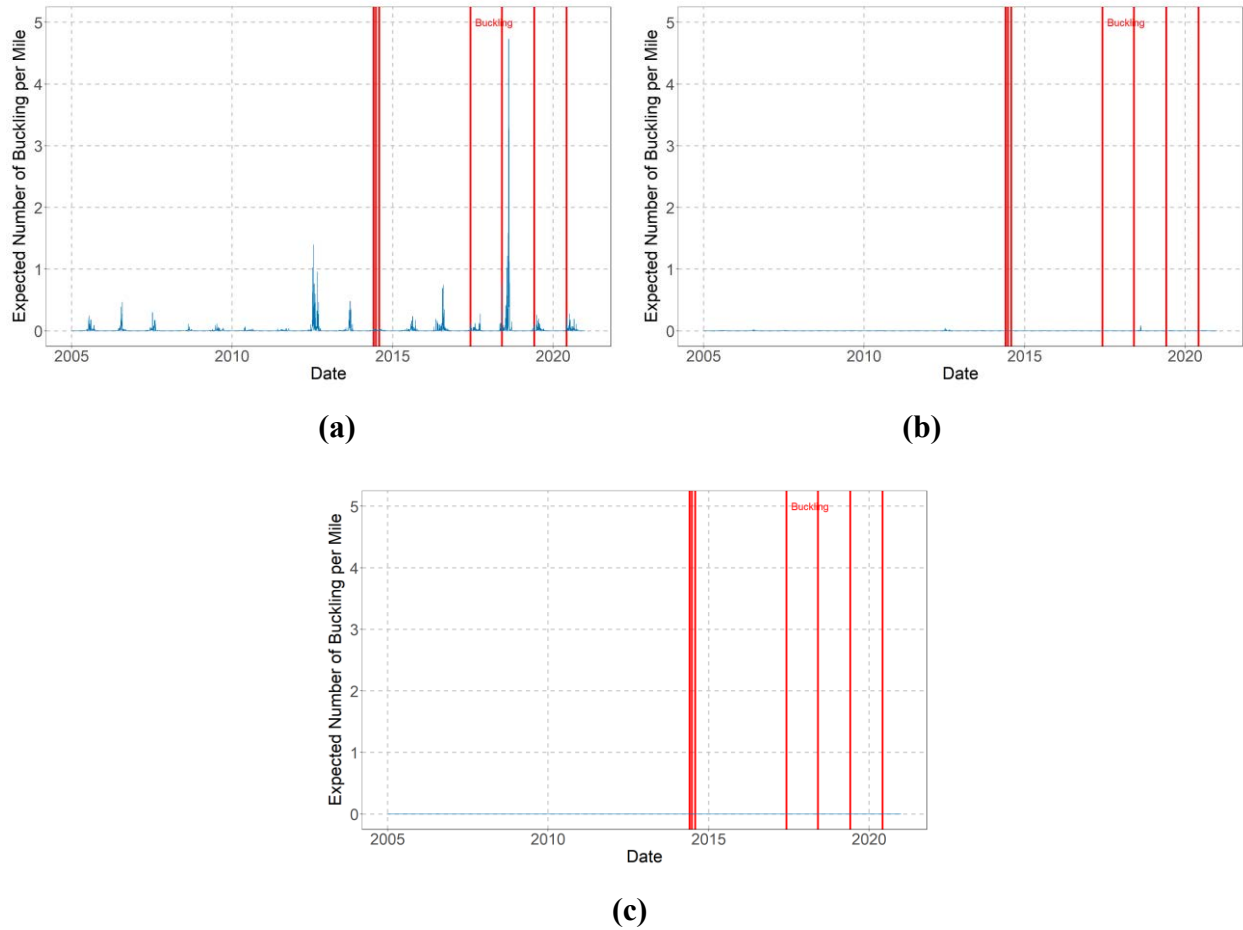


(b)



(c)

**Figure 37. Probability of buckling for site # 7 for neutral temperatures of (a) 50 °F, (b) 70 °F, and (c) 90 °F.**



**Figure 38. Expected Number of Buckled Joints for Site # 7 for Neutral Temperatures of (a) 50 °F, (b) 70 °F, and (c) 90 °F.**

It should be noted that the actual blowups that were observed from the field do not necessarily align with the days predicted to have higher chances of buckling. Such discrepancy observed between the probability of buckling and the actual blowups is believed to be due to the limitations of the mechanistic model including the following:

1. The model does not take into account the spatial variability that is inherent to any field condition, such as the joint condition, PCC/base friction, neutral temperature (because the slabs within a 10-mile section may be constructed at different months), etc.
2. The joint condition during the previous years, cannot be assessed in a reliable manner (i.e., temporal variability). Furthermore, the model does not account for any effect due to joint deterioration (e.g., spalling) over time which may contribute to the cause of buckling.

3. It is practically unfeasible to model the availability (amount and type) of incompressibles for any specific section of roadway, which is a key driver of buckling.
4. The modeling itself represents an extreme event with very low probabilities or a low base rate event. As such, models to match field observations are inherently limited.

Due to these limitations, coupled with the challenges associated with assessing the appropriate inputs for different slabs within a given site, it is deemed that a mechanistic model is not feasible for predicting the actual occurrence of blowups.

### **Sensitivity Analysis**

Although developing a mechanistic model to predict buckling has several challenges, the model is still useful in assessing the impact of various material and environmental parameters on the probability of buckling. As such, this section of the report briefly presents the outcome of the sensitivity analysis of different parameters that may contribute to buckling.

The previous sections indicate that the neutral temperature of PCC plays a crucial role in the probability of buckling. As such, the sensitivity analysis was conducted for PCC materials and PCC/base interface friction related inputs. The variables studied include the following.

- PCC Inputs
  - Joint Spacing
  - Elastic Modulus ( $E$ )
  - Thickness ( $h$ )
  - Poisson's Ratio ( $\nu$ )
  - CTE ( $\alpha$ )
  - Unit Weight ( $\gamma$ )
- PCC/Base Interface Friction Inputs
  - Steady-State Friction ( $\tau_o$ )
  - Slippage ( $\delta_o$ )

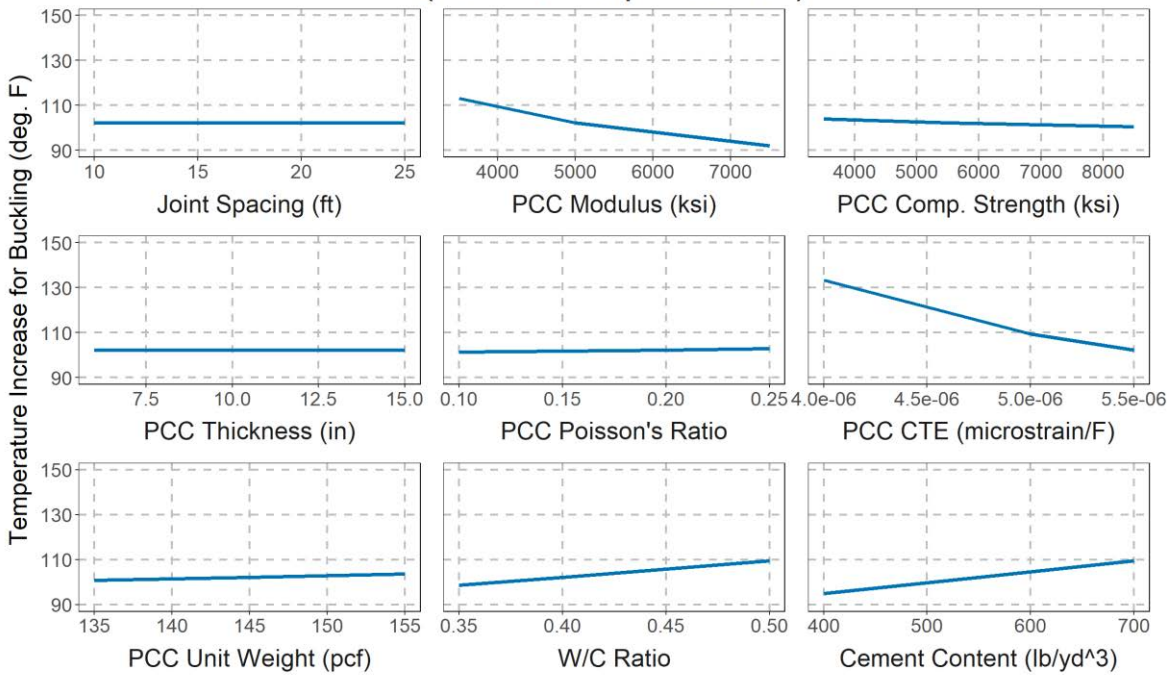
Figure 39 and Figure 40 show the results of the sensitivity analysis at PCC neutral temperature of 70 °F for GB and CTB conditions, respectively. These figures show that the interface friction provided by CTB is more effective in increasing the buckling temperature. Moreover, these figures generally show that PCC CTE has the most predominant effect on the buckling temperature, along with the cement content, w/c ratio, PCC modulus, and unit weight.

On the other hand, the joint spacing, PCC thickness and compressive strength showed negligible effect on the buckling temperature within their practical ranges.

An important assumption inherent in this sensitivity modeling is that the entire slab is uniform and of homogeneous properties, and the mechanistic model is for uniform movement of the entire slab. As such, local effects such as higher stress concentrations due to variability in type, location, and amount of incompressibles; effect of joint spacings and joint openings on the amount of incompressibles in the joints; lower strength due to damaged concrete from spalling and durability distresses; differences in frictional restraint between the center of the slab and the edges of the slab; and many others are not considered in this sensitivity analysis. Many factors are interrelated (e.g., PCC water/cement ratio, PCC compressive strength, and PCC elastic modulus) and may not be fully accounted for within the analysis. A big unknown that is practically impossible to quantify from one location to another and from one site to another is the type and availability of incompressibles. Factors impacting incompressibles entering and lodging in the transverse joints such as source, quantity, gradation, hardness, dominant joint formation, etc., can vary substantially from location to location and as such are highly uncertain factors that impact the risk of buckling of any single joint at any single site. These important caveats are not fully accounted for and need to be understood while interpreting the results of the analytical modeling and sensitivity analysis.

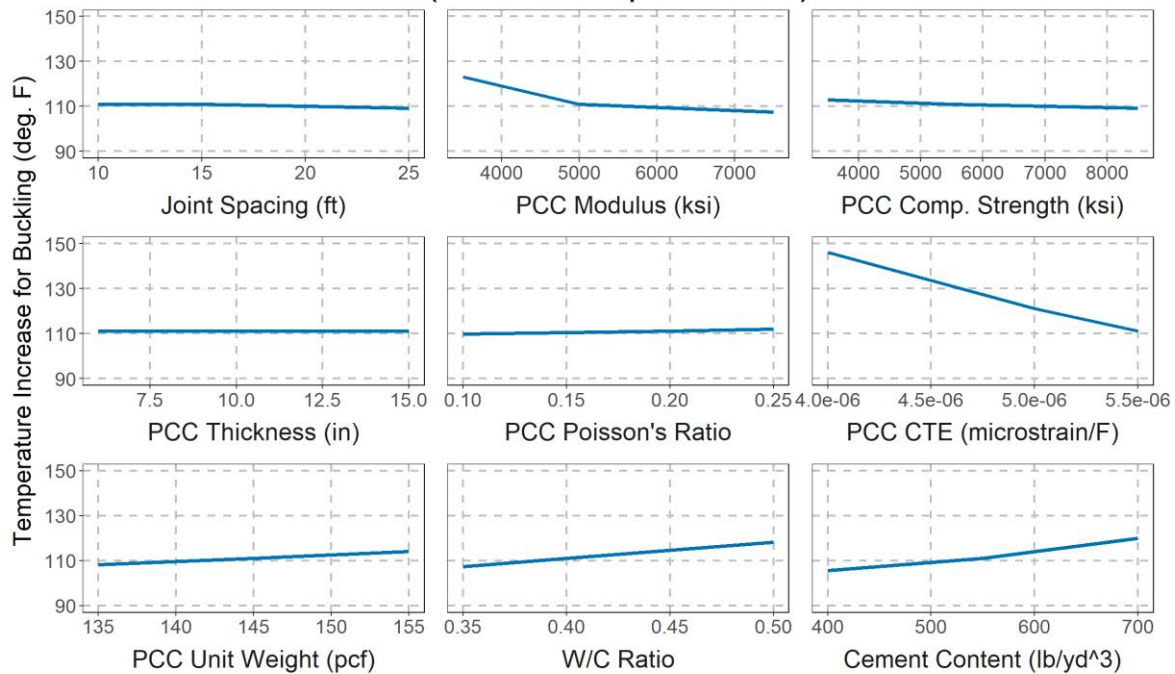


### Sensitivity of Buckling Temperature (50% Incompressibles)



**Figure 39. Sensitivity of Buckling Temperature to Various Inputs (GB).**

### Sensitivity of Buckling Temperature (50% Incompressibles)



**Figure 40. Sensitivity of Buckling Temperature to Various Inputs (CTB).**

## Conclusions

Buckling in PCC pavement is a localized upward movement at or near a joint or crack often accompanied by shattering of the adjacent PCC slabs. Buckling requires a significant maintenance and repair effort and creates a public safety risk. Specifically, in Wisconsin, the frequency and occurrences of buckling have been increasing each year over the past decade or so. This research was undertaken to identify the causes of buckling in Wisconsin and provide recommendations to reduce the frequency and occurrences of buckling in Wisconsin.

As part of this study, the research team conducted a thorough review of literature and interviewed personnel from other highway agencies and those associated with the concrete pavement industry. The research team reviewed design standards, specifications, maintenance and rehabilitation practices, and drainage considerations, of neighboring agencies, to identify differences with Wisconsin standards and provide recommendations. The most significant effort of this research was a field survey of eight buckling sites and three control sites. The field survey consisted of visual inspection of roadway conditions, coring, evaluation of joint condition, subsurface drainage systems, and geometrical parameters, and pulse induction scanning for dowel alignment. The field visit also included interviewing district maintenance staff who had direct experience with maintaining roadways and repairing buckled joints. The field data collected was analyzed and was used along with information obtained from literature to develop an analytical model and perform sensitivity analysis.

The following highlights some key findings from the above-mentioned research activities and the research team's experience with the subject matter:

1. There is no "design procedure" to prevent buckling as there is for other distress types in JRCPC, JPCPC, and CRCP.
2. Each of these types of concrete pavements include hundreds or thousands of transverse joints and cracks along a typical project. Each transverse joint and crack is unique in that each open and close a different amount over time depending on many factors. Transverse joints and cracks exhibit differences from each other in terms of effective joint spacing between working joints, concrete durability, concrete consolidation, dowel alignment, spalling along the joint or crack length, widths and orientations of transverse joint opening/crack beneath the saw cut or transverse crack opening, moisture/humidity levels, etc.

3. Over time and over hundreds and thousands of daily climatic cycles experienced by the concrete pavement during its lifetime, compressive stresses in the slab, and specifically near joints and crack fluctuate dramatically. These stresses are highest in hot and wet weather, triggering at some point in time a critical situation at a critical transverse joint or crack where the local compressive stress exceeds the local concrete strength at some transverse length across the slab and buckling develops at that critical joint or crack. These stresses are not uniformly distributed across the entire cross section at a joint but rather there are areas of high stress concentrations and areas of low stress concentrations at any given joint or crack due to spatial variability in how the crack beneath the sawcut forms, temperature curling and moisture warping of the slabs resulting in differences in joint openings between the slab corner and midslab locations, and how, when, and where incompressibles enter the joint. While the daily climatic cycles are beyond control, as discussed later in this conclusions section and in the recommendations section, steps can be taken to mitigate the pavement response to the climate cycles and reduce these compressive stresses, thus reducing the probability of buckling.
4. The flip side of concrete stress is concrete strength. Concrete strength provides resistance to concrete stress and associated failure at high stress levels. However, concrete strength is not uniform throughout the concrete slab. The local concrete strength, particularly at or near joints, may be lower than at a well-consolidated and cured midslab location due to a variety of factors such as poor consolidation, shrinkage or restraint microcracking (from dowel bars, tie bars, weight of the slab, friction between slab and base, etc.), damage due to durability distresses and spalling (both visible on the surface and not visible beneath the intact surface), damage due to pressure from incompressibles, curing and drying of the saw cuts, etc. Damaged, low strength, or weak concrete is more susceptible to the compressive stresses, and consequently buckling. As in the case of concrete stress, as discussed later in this conclusions section and in the recommendations section, steps can be taken to increase chances of having good quality concrete with sufficient strength at the joints and cracks to withstand compressive stresses.
5. Buckling as a distress type is an incredibly rare event as compared to other distress types. For example, by the end of a concrete pavements typical 40-year design life, depending on many factors, a typical pavement exhibits roughly 10 to 20 percent midslab transverse

cracks and roughly 5 to 25 percent joint spalling of varying levels of severity. By contrast, even in Wisconsin, which has the highest rates of buckling in the U.S., based on a review of the 11 projects evaluated under this study over an 8-year period, the average rate of buckling was slightly lower than one per mile over that time period. This rate translates to approximately 5 blowups per mile over a 40-year pavement life, or approximately 1 to 2 percent of the transverse joints. Many other states, even in the upper Midwest, have blowup rates 2 to 10 times lower than that of Wisconsin, which translates to approximately 0.1 to 1 percent of the transverse joints. Southern and northwestern states have even lower rates of buckling. The reasons for the higher incidences of buckling in Wisconsin and potential remedies are discussed later in the conclusions.

6. The relatively rare occurrences of blowups make developing a performance model for buckling challenging. Buckling is a phenomenon that is exhibited and corresponds to the tail ends of a statistical distribution and require many factors to align for an individual joint or crack to buckle. Each year, it only takes a small number of deficient joints or cracks along a project to result in a blowup out of hundreds and thousands of adequate joints that do not buckle. Yet, it is important to recognize that these small number of blowups can be a safety hazard and expensive to repair, which is why it is necessary to address buckling through some practical solutions.
7. Mechanisms for buckling focus on high compressive stresses in the concrete slab that are induced by expansion of the slab due to an increase in temperature of the slab. Any slab temperature that is higher than the neutral temperature (temperature of the slab when the concrete solidifies and is approximately the set temperature) results in compressive stresses in the slab near the joint or crack. The greater the slab temperature relative to the neutral temperature, the greater the risk of buckling. As such, low neutral temperatures that can arise when concrete sets during cold winter days, or is placed on a cold base course, means that concrete will have higher compressive stresses at relatively lower temperatures, resulting in buckling at relatively lower temperatures. For example, consider two identical pavement sections: one constructed during a cold winter day with a neutral temperature of 50 °F and the second constructed during a mild spring day with a neutral temperature of 70 °F. All other factors being equal, if the first pavement has a one

percent probability of having a joint buckle during a humid summer day with a concrete temperature of 95 °F, the second pavement would have to experience a concrete temperature of 115 °F at the same level of concrete moisture content to have the same one percent probability of buckling. Thus, the first pavement will buckle at a relatively lower temperature as compared to the second pavement. Stated another way, the second pavement will have a significantly lower probability of buckling (far less than one percent) at a concrete temperature 95 °F as compared to the first pavement (one percent).

8. In addition, any increase in moisture content also adds to the expansion and contributes to the compressive stresses in the slab. On the other hand, the concrete slab will also exhibit some permanent shrinkage that helps reduce a portion of the compressive stresses. In another complex interaction between moisture and temperature, the CTE of a concrete slab is highest at about 70 percent relative humidity in the slab and decreases as the slab reaches 100 percent relative humidity. As such, at higher humidity levels whereas the expansion of the slab due to moisture is higher, the expansion of the slab due to temperature is slightly reduced. Other expansive forces such as due to reactive aggregates potentially adds to the compressive stresses. Localized restraint against this expansion, such as due to incompressibles in the joint, further add to the compressive stresses.
9. In any given year, the risk of buckling is highest during the highest temperatures and moisture contents of the slab, which occurs during the hot and humid summer afternoons following days of precipitation. For example, a large percentage of blowups occurred in Illinois in the 1950s (JRCF only) when the air temperature was equal to or greater than 90°F, 73 percent occurred in the month of June, 75 percent of all blowups occurred within a week following a rainfall, and 85 percent of all blowups occurred between 1:00 and 6:00 P.M. The Wisconsin data showed that between 2013 to 2020, 83 percent of blowups occurred when the air temperature was equal to or greater than 90°F, 40 percent of blowups occurred in the month of June, 30 percent in the month of July, and 25 percent in the month of May, and 82 percent of blowups occurred between 2:00 and 7:30 P.M. The vast number of blowups occur in afternoon during the hot summer days and within a week following a rainfall event. These are the times of year and day with the highest increase in effective temperature in the slab relative to the neutral temperature.

10. The key factors impacting buckling during any given day and any given stretch of roadway include the following. Note that not all factors contribute equally and there is also considerable correlation between some of these factors.

- The maximum temperature of the slab that will occur during that day. The higher the maximum temperature, greater the expansion of the concrete slabs, and higher the risk of buckling.
- The relative humidity of the slab during the time the maximum temperature occurs. The higher the relative humidity of the slab, greater the expansion of the concrete slabs, and higher the risk of buckling.
- The neutral temperature of the concrete slab established when the concrete is paved. Lower neutral temperature translates to a higher risk of buckling at lower concrete in-service temperatures compared to higher neutral temperatures because less joint opening is available for the concrete slabs into which to expand.
- Higher CTE values translate to higher thermal expansion, higher compressive stresses, and higher risk of buckling for the same change in temperature relative to the neutral temperature.
- Some types of reactive aggregates in hardened concrete can undergoes sizable expansion when affected by aggregate freeze-thaw or alkali reactions, such as alkali aggregate reaction (AAR), alkali carbonate reaction (ACR), and alkali silica reaction (ASR). The freeze-thaw or chemical reactions can result in both an expansion of the concrete (adding to compressive stresses) and weakening of the concrete resulting in reduced localized strength (due to microcracking of the concrete around the aggregate), resulting in an overall higher risk of buckling.
- Incompressibles that infiltrate joints reduce the amount of opening available for a slab to expand into, thus increasing compressive stresses, and risk of buckling. The amount, size, and hardness of the incompressibles all contribute to the likelihood of buckling. Incompressibles infiltrate the joint from the top sawcut (wind blow from adjacent areas such as gravel or turf shoulders, aggregate popouts from the concrete surface and tines, sand and grit used for winter maintenance, aggregate haul trucks, vehicle tires carrying soil from nearby dirt or gravel roads, etc.), from the bottom through pumping of the subsurface layer

materials, and from deterioration of the existing concrete, such as from spalling, durability cracking, or high localized stresses resulting from thermal opening and closing of the joints. The amount and type of incompressibles available to enter any specific joint at any specific site is practically impossible to quantify. Factors impacting incompressibles entering and lodging in the transverse joints such as source, quantity, gradation, hardness, etc., can vary substantially from one location to another. These highly uncertain factors can impact how much incompressibles enter the joints, how quickly they migrate and collect at the bottom (cracked) portion of the joint, and the pressures exerted against the concrete by the incompressibles. Thus, these factors have a great impact on the potential for buckling of any single joint at any single site.

- The presence of dominant joints may also be a contributing factor to buckling. Depending on the amount of drying shrinkage and thermal contraction in the hours and days following concrete placement, only some of the pavement joints may have activated (cracked beneath the sawcut), while other joints may not have activated or take much longer to activate, creating what are sometimes called “dominant joints” at every third, fourth, or fifth joint. The mechanism by which dominant joints impact buckling is not clear. One mechanism is by effectively increasing joint spacing. In this situation, it is quite likely that dominant joints open and close more than other joints, thus collecting more incompressibles and resulting in higher risk of buckling of these dominant transverse joints. Another mechanism is when dominant pavement joints are not able to close all the way because the transverse joints in adjacent lanes or tied shoulders close first, thereby restraining the dominant joints from closing completely. In this situation, adjacent joints near the dominant joint have tighter cracks beneath the sawcut and less room for the slabs to expand into during moist summer days, and thus higher risk of buckling.
- Durability distresses at transverse joints and cracks, such as due to d-cracking, salt damage (particularly from the use of salt for winter maintenance activities), moisture damage, etc., result in a weakened concrete, which could lead to lower

concrete strength, less resistance to compressive stresses, and a higher risk of buckling.

- Lower friction between slab and base course (e.g., when concrete is placed on an unbound aggregate base course) versus higher friction (e.g., when concrete is placed on a stabilized base course) increases the opening and closing of joints/cracks over time. As compared to lower friction bases, higher friction bases help dissipate some of the compressive stress build up by providing greater uniform resistance to the thermal and moisture expansion. The slightly higher frictional shear stresses distributed uniformly through the longitudinal length of the concrete slab translates to lower compressive stress at the ends of the slab near the transverse joint or crack, and lower risk of buckling.
- Spalling of transverse joints and cracks may contribute to increased buckling or may be a precursor signifying the future potential of the joint to buckle. Several factors may be contributing to the impact of spalling on buckling: (1) uneven joint or crack face creates uneven stress concentrations and potential for high buildup of compressive stresses, (2) lower cross sectional area to resist expansive forces increases potential for high buildup of compressive stresses, (3) spalled joints may signify weak or deteriorated concrete of lower strength at the joint and less capacity to accommodate compressive stresses, and (4) spalled pieces of concrete and small aggregate may fall into the joint opening increasing the amount of incompressibles in the joint, further contributing to a higher risk of buckling.
- The longer the joint spacing (between working joints) the higher the risk of buckling. Longer jointed pavements have more movement and opening and closing of the joint as compared to short-jointed pavements. As such, the consequences of any restraint against this movement is more severe in long jointed pavements as compared to short jointed pavements. While the buckling model sensitivity analysis does not show a direct sensitivity of joint spacing with buckling probability, the impact is likely indirect through differences in amount of incompressibles in the joints and distribution of joint openings, both of which are considered independently from joint spacing in the sensitivity analysis and do have a direct impact on buckling probability. However, there is a point of



diminishing returns in terms of joint spacing. The greatest benefit is likely obtained in going down from JRCP to JPCP. There might not be too much benefit in further reducing joint spacing.

- Joints that have multiple dowels that are significantly out of alignment can lock up, resulting in effectively a longer joint spacing and increased risk of buckling. Dowels that are properly aligned or moderately misaligned are not known to lock joints and thus do not impact risk of buckling.
- The amount of permanent drying shrinkage in concrete affects joint opening and closing. The greater the drying shrinkage the lower the compressive stress and the lower the risk of buckling. However, very high levels of drying shrinkage may cause other problems such as with achieving desired concrete durability, which in turn could increase the risk of buckling.
- Concrete slab moisture content increases after an asphalt overlay has been placed resulting in increased compressive stress and increased risk of buckling.
- Thinner concrete slabs (less than 7 inches) result in higher slab compressive stresses that are more susceptible to buckling. These slabs may experience the similar amounts of expansive forces as compared to thicker slabs, but the expansive forces are distributed over a smaller cross-sectional area, resulting in higher compressive stresses, and higher buckling risk. Thinner concrete slabs have less friction between the slab and the base course, which could contribute additionally to an increased risk for buckling.
- Spall or cracking maintenance repairs can increase the risk of buckling if not done properly. Partial depth patching that simply removes the loose concrete in a spalled area and replaces it with hot or cold asphalt mix results in a highly variable face along the transverse joint that could lead to high localized compressive stresses and a blowup. Replacement with a concrete partial depth patch provides more structure that can bear horizontal compression stresses.
- Full-depth asphalt repairs placed in any portion of a traffic lane will often result in being compressed by the adjacent slabs on both ends causing a very high compressive stress in any adjacent concrete in the lane or adjacent lanes resulting in a high risk of buckling of the remaining concrete during hot weather.

- Concrete pavements with paved shoulders have fewer blowups compared to gravel or turf shoulders. This impact is perhaps due to less incompressibles infiltrating into the travel lane joints with paved shoulders as compared to travel lane joints with gravel and turf shoulders. The availability and type of incompressibles that infiltrate into the transverse joints and cracks can be a significant risk factor. Wide shoulders (and vegetation beyond the shoulders to control wind and water erosion) can potentially decrease the risk of incompressibles getting into the mainline transverse joints by increasing the distance between the mainline lanes and the base, subbase, ditches, turf, or subgrade that extend beyond the shoulders, and decreasing the amount of incompressibles available. It is likely that tied concrete shoulders may fare better than asphalt shoulders if there is the likelihood of the asphalt shoulders separating or settling at the longitudinal lane-shoulder joint. This joint if opened and unsealed can be a source of incompressibles from the base course immediately underneath the longitudinal joint.
11. Time since construction or pavement age increases the likelihood of buckling. The first few years following concrete placement have low buckling, but one or more of the factors listed above are worsening over time to cause an increase in the probability of buckling. These include (1) increase in the amount of incompressibles collecting in the joints each year contributing to an increase in compressive stresses, (2) spalling of the concrete near the joints over time creating uneven contact and higher compressive stresses, (3) temporary patching of spalls with asphalt along portions of the transverse joints that result in highly variable slab to slab contact across the transverse joint resulting in a increase in compressive stresses, and (4) an increase in maximum temperatures over pavement life due to climate change that contribute to an increase in compressive stresses.
  12. A common occurrence noted among most cores taken at both the buckling sites and the control sites was the presence of middepth horizontal “delamination” cracks parallel to the roadway surface that seem to start at or near the dowel bars. These were more common, more pronounced, and more deteriorated at cores from the buckling site as compared to the control sites. These cracks seem to extend middepth for a few feet away

from the transverse joint in the longitudinal direction and in some cases turn upwards and spall the joints. We currently believe that these cracks begin to form early in the life of the pavement due to restraint from the dowel bars against curling and warping during or immediately following setting of concrete when it is just starting to gain strength. It is likely that there is a link between buckling and this middepth horizontal delamination cracking. However, we are unclear how one phenomenon is related to the other, and specifically what is the cause and what is the effect.

13. CRCP in Wisconsin has experienced a much lower level of buckling than JPCP. The cause of these blowups was not determined in this study, but the findings from Illinois and other agencies may be applicable to Wisconsin as well. There appear to be three main causes of buckling of CRCP.

- Transverse cracks that widen and eventually rupture the reinforcement. If these are not repaired for months or years, they fill up with incompressibles which contributes to buckling of the CRCP.
- Construction joints in CRCP often have serious weaknesses (e.g., non-consolidated concrete) that may result in increased probability of buckling of the in-service CRCP if the concrete deteriorates significantly at these joints.
- Repair of a wide transverse crack or punchout with a partial lane width full depth repair using material other than concrete. These repairs set up high compressive stresses in the remaining original existing lane greatly increasing the risk of buckling.

14. The key factors contributing to the higher incidences of buckling in Wisconsin relative to other midwestern states and northeastern states, and much higher incidences of buckling relative to southern and northwestern states are as follows:

- Hot and humid summers with rainfall: Summer temperatures in Wisconsin can be well into the 90s lasting several days in a row. Humidity levels can reach 70 to 90 percent regularly during these hot summer months, in addition to several days of significant rainfall events totaling over 30 inches of precipitation each year.
- The above should be considered in the context of PCC construction during cold winter months. Wisconsin allows for concreting operations up to the point where the descending air temperature falls below 35 °F and allows for beginning

concreting operations when the ascending air temperature in the shade and away from artificial heat reaches 30 °F. It is quite probably that occasionally the granular base upon which the concrete is placed is at an even lower temperature. All this contributes to a potentially low neutral temperature which translates to a lower summer temperature and humidity level at which buckling can occur.

- Note that a several other upper midwestern states also experience the similar climate and temperatures during concreting operations as described above. The following factors further add to the increased risk of buckling in Wisconsin.
  - a. Joint sealing: Wisconsin uses a single saw cut that is left unsealed throughout the life of the pavement. This contributes to more incompressibles in the joints, that contributes to increased compressive stress, increased salt damage, and increased moisture in the joints that adds to moisture and salt damage.
  - b. Base course: Wisconsin typically uses an unbound aggregate base course beneath the concrete slab. The lower friction of the unbound aggregate base course as compared to a treated base course, contributes to increased joint opening and additional compressive stress at the ends of the slabs.
  - c. Concrete durability: Many Wisconsin pavements do not provide for positive drainage (such as using edge drains or daylighting a permeable base). The additional moisture in the joints stays there longer than if there was a functioning drainage layer. Some of the concrete pavements constructed in the 2000s may not have been constructed with modern durability standards. Modern durability standards consist of less permeable concrete as can be measured using concrete resistivity and good distribution of entrained air as can be measured using the super air meter (SAM). The lower durability of the concrete combined with moisture and salt damage likely resulted in weaker concrete near the joints, contributing to buckling.
  - d. Asphalt patches: Spalled joints are typically patched with asphalt patches in Wisconsin. Asphalt patches and spalled joints are correlated with buckling. They are seen to be a precursor to buckling signifying that a joint may buckle soon and may even directly contribute to a higher risk of buckling.

## Recommendations

The following highlights key recommendations based on the research activities and the research team's experience with the subject matter:

- **Fill joints with a filler/sealant:** Incompressibles and water entering joints, particularly when they are unfilled or unsealed, are both factors contributing to the higher risk of buckling in Wisconsin. Filling or sealing joints and maintaining the filler/sealant over the life of the pavement will help reduce incidences of buckling in Wisconsin by reducing the amount of incompressibles that collect within the joint and by reducing the amount of durability damage to the joint due to water and deicing chemicals. While sealed or filled joints do not eliminate water from entering the joints, they do play a role in reducing the amount of water entering the joints. The research team recommends a single saw cut filled with a low modulus filler/sealant as specified by Ontario.
- **Review cold weather concreting practices:** While much of the concrete in Wisconsin is placed during warmer times of the year, the construction season in Wisconsin stretches well into the winter months. It is likely that concrete is placed on portions of Wisconsin roadways when the ambient air temperature and/or the temperature of the base course upon which the concrete was placed, was quite low and near freezing. A review of Wisconsin specifications, cold-weather concreting practices, and associated quality control (QC) plans would be beneficial to reduce the likelihood of concrete placed during cold temperatures which contributes to lower neutral temperatures and higher risk of buckling. The review should include documentation of current practices in Wisconsin by looking at construction records and comparing them with WisDOT specifications and those of other agencies. The impact of potential changes in bid prices due to potential changes in cold weather concreting specifications should also be considered as part of this review.
- **Specify strong durable concrete:** Wisconsin DOT is well on its way working towards improving concrete durability. Wisconsin has been investigating optimized mixture gradations, tests for workability to reduce likelihood of poor consolidation, entrained air distribution using the Super Air Meter, use of supplementary cementitious materials (SCMs), and resistivity as a measure of moisture and salt transport in concrete. These modern standards for achieving quality concrete are expected to contribute to the

durability of concrete at or near joints and to reducing the risk of buckling. Higher strength, if can be achieved with durable concrete, acts as a counterweight to high compressive stresses. Higher strength concrete can withstand higher compressive stresses build up within the concrete resulting in increased strains within the concrete before it fails/cracks locally, which happens when the stresses exceed the strength. However, there is a limit to how much strength can be increased. As such, higher concrete strengths could be specified if and only if it meets all the specified durability requirements in a cost-effective manner. Optimized concrete mixtures allow for obtaining higher strength and durability while optimizing the amount of cementitious material in the concrete mix. Note that when a joint is sealed/filled, the saw cut could act as a small reservoir for the temporary collection water (and salt water) underneath the sealant/filler, which could impact joint performance and buckling negatively. However, the benefits of sealing/filling far outweigh this concern. Gravity and subsurface drainage along with joint movement due to traffic and due to thermal opening and closing of the joint will eventually draw the water downward. Another reason for using quality durable concrete to reduce the detrimental impact of this collected water.

- Use concrete with lower CTE: Wisconsin DOT can either specify CTE requirements for their concrete pavements or when a choice is presented, opt for concrete with lower CTE. The research team acknowledges that using coarse aggregates with a lower CTE may sometimes not be a practical option if the costs to transport lower CTE aggregates are exceedingly high. When using concrete with lower CTE is not a practical option due to the locally available coarse aggregate, the research team recommend increased emphasis on some of the other recommendations.
- Repair spalled joints with concrete full- or partial depth patches as soon as practical: When spalling is identified along a transverse joint or crack, maintenance should be directed to consider the spalled joint as a potential buckling situation and schedule a full depth repair of the joint for the full width of the lane. Asphalt patches can be used as a temporary fix for spalled areas, but these should be repaired with durable full depth concrete patch for larger spalls or durable partial depth concrete patch for smaller spalls prior to the next summer. Spalled joints are either a contributor or an indicator of potential future buckling and should be repaired before the joint buckles.

- Provide positive drainage in areas susceptible to water: Cut sections, sag areas, and low-lying areas close to water tables, etc., have higher likelihood of increased moisture within the pavement structure. Positive drainage, such as by using permeable (but stable) base courses, and daylighting or edge draining these base courses to remove water quickly from the pavement structure, can help with reducing humidity levels in the concrete, and can also help with reducing moisture damage in the concrete since the quality of concrete at the joints is a factor that contributes to the occurrence of buckling at that joint. If the concrete durability is excellent (good consolidation, low permeability, good entrained air distribution), it has a higher likelihood of withstanding salt and moisture damage at the joints, in which case positive drainage may not be needed. Figure 61 in Appendix F shows one such example of positive drainage from Michigan DOT.
- Use a stabilized base course: Stabilized base courses reduce the amount of opening and closing of transverse joints thus reducing the amount of incompressibles getting into the joints. The higher friction of stabilized base courses as compared to unbound aggregate base courses result in less compressive stress in the concrete near the joints, reducing the risk of buckling. Most of Wisconsin JPCP includes dowels, widened lanes, and tied shoulders. These design features result in much less pumping potential. Thus, the primary role for a stabilized base will be to reduce joint opening through frictional restraint between the slab and stabilized base and as a stabilized construction platform.
- Use wider paved shoulders and vegetation beyond shoulders: wind blow from adjacent areas such as gravel or turf shoulders is one of the sources of incompressibles that enter the mainline pavement joints. Wider shoulders (to increase distance) and vegetation beyond the shoulders (to reduce wind and water erosion of the soil) can help reduce availability of incompressibles and consequently buckling risk. It is likely that tied concrete shoulders may fare better than asphalt shoulders if there is the likelihood of the asphalt shoulders separating or settling at the longitudinal lane-shoulder joint. This joint if opened and unsealed can be a source of incompressibles from the aggregate base course immediately underneath the longitudinal joint.
- Force joints to activate: It is unclear from the current research the extent to which dominant joints (and other joints near dominant joints) impact the likelihood of buckling and also the mechanisms of these impacts. However, it stands to reason that the

existence of dominant joints skews the distribution of joint openings in and around dominant joints more so than if there are no dominant joints. If joints do not activate early in the life of the pavement, they likely do not provide sufficient opening of the crack beneath the transverse sawcut to expand into during the hot humid summer days. The dominant joints themselves may also collect more incompressibles because of the wider openings and have a higher risk of buckling. The research team does not believe there is a negative consequence of forcing joints to activate shortly following construction and sawcutting. We recommend that WisDOT work with contractors and industry to investigate methods to activate more joints early in the life of the pavement. One possibility is by driving a heavy axle load slowly on the concrete pavement after sawcutting and once the concrete has gained sufficient strength to safely handle the load.

- Use pressure relief expansion joints as a last resort: Some states have experimented with expansion joints on roadways where buckling has occurred. The experience of many of these states suggest that expansion joints work for a few years before they begin to close and deteriorate, and a full depth repair of the expansion joint needs to be performed. For emergency use on a project that is experiencing lots of buckling, expansion joints at critical locations (such as sag areas) will generally reduce the number of future blowups, but they often have a significant downside in terms of additional maintenance. Installation of expansion joints on new construction is required in some European countries such as Belgium and Germany for concrete pavement placed below a specified paving temperature. The downside is that these expansion joints require maintenance and attention for years to come. As such, the research team does not recommend pressure relief expansion joints except in situations where all other alternatives have been exhausted.

In addition to the above recommendations, the following are some additional recommendations for CRCP.

- Transverse cracks in CRCP can sometimes widen and eventually rupture the reinforcement. If these are allowed to stay unrepaired for months or years, they fill up with incompressibles that then contribute to buckling of the CRCP. The recommended solution is to require the repair of these wide cracks with a full lane width full-depth reinforced repair as soon as possible.



- Construction joints in CRCP often have serious weaknesses (e.g., non-consolidated concrete) that may result in buckling of the in-service CRCP if the concrete deteriorates significantly. Thus, increased quality control and inspection of construction joints in CRCP should be required to reduce the potential for buckling years later.
- Repair of a wide transverse crack or punchout with a partial lane width full depth repair using material other than concrete sets up high compressive stresses in the remaining original existing lane width greatly increasing the risk of buckling. Repairs should be full lane width and depth to minimize the potential for buckling in CRCP.

The research team also recommends that WisDOT evaluate the impact of executing one or more of these recommendations in terms of initial costs, bid prices, life cycle costs, pavement maintenance and rehabilitation costs, etc., and analyze the costs in view of the benefits such as reduced buckling and improved pavement performance.

## **Appendix A: Risk Factors for Buckling**

### **Climate (Temperature and Moisture)**

Temperature and moisture have significant effect on the occurrence of blowups due to the increase in axial compressive forces induced into the pavements. It has been well established that the primary factor of pavement blowups is high temperature. A statistical analysis on the occurrences of concrete pavement buckling showed that 90 percent of buckling occurred when the air temperature was equal or greater than 90 °F, 72.8 percent in the month of June, 85 percent between 1:00 to 6:00 P.M., and 75 percent within a week of rain (Illinois Division of Highways 1957). Similar findings were found in other studies (Yoder and Foxworthy 1972).

Moisture increases in the concrete slab may be expressed by an equivalent temperature rise. The occurrence of blowups was found to correlate with moisture, primarily in the form of rainfall. The most frequent occurrence of blowups is when a hot day is followed by a rainy night succeeded by another hot day, causing temperature and moisture expansion (Yoder and Foxworthy 1972).

During cold temperatures, concrete pavements contract, which allow joints to open and potentially fill with incompressibles. These incompressibles may resist the expansion of the slab upon an increase in temperature thus increasing the risk of blowups. A safe range of temperature increases was developed based on many factors including slab thickness and the axial shear resistance at the interface of pavement and base (Kerr and Dallis, 1985). This range should be below a neutral temperature to control the occurrence of buckling. The neutral temperature represents the temperature at which the PCC material solidified to form the hardened slab at which the axial compressive force within the concrete pavement is zero after construction (Kerr and Dallis 1985). Thus, the placement of concrete pavements at higher temperatures may reduce the likelihood of blowups (Smith et al. 1987).

### **Coefficient of Thermal Expansion**

Since the CTE of concrete largely depends on the type of coarse aggregate, the selection of coarse aggregate could be considered to minimize volume expansion of concrete. The CTE of concrete is defined as the change in unit length per degree of temperature change. The smaller the CTE, the smaller the change in length of the concrete due to temperature changes. The use of aggregate with low CTE can help reduce the axial compressive forces induced in the pavements. The CTE of concrete is highest at a relative humidity of about 70 percent and 20 to 25 percent

lower when the concrete is fully saturated (Hall and Tayabji 2011). Note that the laboratory test for CTE is conducted under saturation conditions to control the humidity in the concrete, although the CTE of concrete at 100 percent humidity is not as high as at 70 percent humidity (Hall and Tayabji 2011).

The effect of coarse aggregate on pavement buckling has been investigated, but it did not reveal solid findings. In 1948, a research study was conducted to correlate pavement blowups in Indiana with source of coarse aggregates based on collected data obtained from blowup reports (Woods and Sweet 1948). The researchers found that a correlation existed between certain coarse aggregate sources used in the concrete mix and the buckling performance of the pavement. Several sources of aggregate considered as primary causes of blowups were eliminated as a result of this study (Foxworthy 1973). The study found both stone and gravel coarse aggregate could contribute to buckling activity (Yoder and Foxworthy 1972, Woods and Sweet 1949). By contrast, another study found no significant difference between gravel and crushed stone as contributing factor to blowups (Foxworthy 1973). The use of unsound and expansive aggregates considerably increased the number of blowups as aggregate has a significant effect on the durability of concrete pavements (Yoder and Foxworthy 1972). Research studies conducted in Indiana and Illinois did not find a correlation between fine aggregate and blowups or type of cement and blowups (Foxworthy 1973).

### **Strength and Durability**

Strength and durability are the traditional and important properties of concrete pavement that must meet agency specifications to provide adequate resistance against compressive and flexural stresses. Concrete pavements are inherently durable if properly designed and constructed. There are many factors that impact the durability of concrete including materials-related distress and construction deficiency (i.e., consolidation, finishing, and curing). Table 9 lists types of materials-related distress that can occur in concrete pavements along with manifestations, causes, typical times of appearance, and methods of prevention or reduction (Van Dam et al. 2002a).

**Table 9. Types of materials-related distress (Van Dam et al. 2002a).**

<b>Type of Materials Related Defect</b>	<b>Surface Distress Manifestations and Location</b>	<b>Cause or Mechanisms</b>	<b>Time of Appearance</b>	<b>Prevention or Reduction</b>
<b>Due to Physical Mechanisms</b>				
Freezing and thawing deterioration of hardened cement paste	Scaling or map cracking, generally initiating near joints or cracks; possible internal disruption of concrete matrix.	Deterioration of saturated cement paste due to repeated cycles of freezing and thawing.	1–5 years	Addition of air entraining agent to establish protective air–void system.
Deicer scaling and deterioration	Scaling or crazing of the slab surface.	Deicing chemicals can amplify deterioration due to freezing and thawing and may interact chemically with cement hydration products.	1–5 years	Limiting w/cm ratio to no more than 0.45 and providing a minimum 30-day drying period after curing before allowing the use of deicers.
Deterioration of aggregate due to freezing and thawing	Cracking parallel to joints and cracks and later spalling; may be accompanied by surface staining.	Freezing and thawing of susceptible coarse aggregates results in fracturing or excessive dilation of aggregate	10–15 years	Use of nonsusceptible aggregates or reduction in maximum coarse aggregate size. 10–15 years
<b>Due to Chemical Mechanisms</b>				
ASR	Map cracking (rarely more than 50 mm deep) over entire slab area and accompanying pressure-related distresses (spalling, blowups)	Reaction between alkalis in cement and reactive silica in aggregate, resulting in an expansive gel and the degradation of the aggregate particle.	5–15 years	Use of non-susceptible aggregates, addition of pozzolans, limiting of alkalis in concrete, addition of lithium salts.
Alkali–carbonate reactivity	Map cracking over entire slab area and accompanying pressure-related distresses (spalling, blowups).	Expansive reaction between alkalis in cement and carbonates in certain aggregates containing clay fractions.	5–15 years	Avoiding susceptible aggregates or blending susceptible aggregate with nonreactive aggregate.
External sulfate attack	Fine cracking near joints and slab edges or map cracking over entire slab area.	Expansive formation of ettringite or gypsum that occurs when external sources of sulfate (e.g., groundwater, deicing chemicals) react with aluminates in cement or fly ash	1–5 years	Minimizing tricalcium aluminate content in cement or using blended cements, class F fly ash, or GGBFS.

In Utah and Indiana (Darter and Peterson 1970, Hoerner et al., 1995, Foxworthy 1973, Gress 1976), researchers observed that pavement blowups occurred more frequently in areas where sand/grit and salt were heavily used during maintenance to melt ice/snow accumulated on paved surfaces. The pavement joints in these areas exhibited the most spalling over time and contained the most amount of incompressibles.

The quality of the air-void system is a crucial factor to protect the concrete pavement from the expansion of water during freezing, which enhance pavement durability. Poor air-void systems can induce pavement distress including spalling, scaling, and freeze thaw damage, which reduces the stiffness of joints.

The use of aggregates that have potential for freeze-thaw damage (e.g. d-cracking) or expansive aggregates (alkali-aggregate reaction and alkali-silica reaction) can contribute to blowups as well as pushing shoulder and bridge abutments (Harrington et al. 2018). Concrete expansion due to the use of these aggregates can accelerate buckling. Therefore, aggregate should be evaluated for freeze-thaw damage and reactivity potential.

## **Foundation**

None of the reported studies indicate the need for special subgrade soil and base/subbase type to control pavement buckling. There are no specific references pointing to strict requirements on subgrade soil and base type for design considerations. Over the last several decades, a few studies were conducted to evaluate the effect of many parameters including subgrade soil type on pavement blowups (Yoder and Foxworthy 1972). In a Maryland study, researchers found that blowups occurred more frequently where the pavement was placed on moderate permeable subgrade, which had a medium-high plasticity index. In an Illinois study, no correlation was found between subgrade soil type and blowups. Subgrade soil is not a significant factor contributing to pavement buckling. Regarding the effect of base/subbase materials on pavement buckling, one study found that pavements placed on a stone subbase and gravel perform better than local sand borrow subbase (Yoder and Foxworthy 1972).

Type of base course, stabilized or unbound aggregate, impacts the amount of opening and closing of joints. Utah found that to estimate joint opening for a stabilized base (CTB or ATB) requires the multiplication of the computed free joint opening with no restraint by 0.65 (e.g., a reduction of 35 percent). An unbound aggregate base requires the multiplication of the free joint

opening by 0.85 (e.g., a reduction of 15 percent) (Darter and Peterson 1970). This represents a difference of about 20 percent between unbound aggregate and CTB.

### Age since Construction

Studies conducted in many states observed that the age of pavements correlated well with blowup activity. In general, blowups occurred after three to nine years following pavement construction, however, a few cases of blowups were reported after only one year following pavement construction (Foxworthy 1973). In Indiana, the occurrences of blowups continued to increase as the age of the original pavements reached 40 years.

Regarding resurfaced concrete pavements, the frequency of blowups starts very soon after an HMA overlay was placed on an existing concrete pavement since concrete slab moisture content increases after an HMA overlay has been placed.

### Shoulder

Some limited studies have investigated the impact of shoulder type on the occurrence of pavement blowups. Most studies suggested that shoulders were a source of infiltration of incompressibles into joints. Based on this assumption, the predominant type of each shoulder, where buckling occurred for each section of a road in Indiana, was recorded in order to evaluate their effect on blowups (Foxworthy 1973). The key findings of the Indiana study (Table 10) showed that paved shoulders have significantly reduced the percent of miles with four or more blowups per mile as compared to gravel or turf shoulders. 25 percent of all roads with paved shoulders had no blowups, while gravel and turf shoulders were virtually indistinguishable in terms of buckling performance. It should be noted that the type of paved shoulder was not identified in the study, but since this study was performed in the early 1970s, it likely referred to an HMA shoulder.

**Table 10. Effect of shoulder type on blowups (Foxworthy 1973).**

Level	Shoulder type	Miles of Road				Percent of Miles		
		No Blowups	< 4 Blowups per mile	≥ 4 Blowups per mile	Total Miles	No Blowups	< 4 Blowups per mile	≥ 4 Blowups per mile
1	Paved	148.6	267.7	174.0	590.3	25.2	45.3	29.5
2	Gravel	216.8	799.7	871.5	1,888.0	11.5	42.4	46.1
3	Turf	102.3	397.2	432.6	932.1	10.9	42.7	46.4

## **Joint Spacing**

Many investigations and general experience of states who have built long -jointed JRCP and then switched to short-jointed JPCP or CRCP indicate that the risk of blowups is greatly reduced. Joint spacing directly affects the amount of joint opening and closing when subjected to temperature and/or moisture changes. Thus, longer joint spacing results in wider transverse joints during winter periods. Wider joints increase the chance of incompressibles infiltration (Burke 1998). Following several cold winter cycles of infiltration of incompressibles, the longer joint spacings result in a buildup of higher and higher compressive stresses at the joints during hot weather, which then causes increased buckling (Utah 1975; Foxworthy 1973; Burke 1998; Harrington et al. 2018; Rens 2018).

In addition, many transverse cracks developed in JRCP. Due to the low reinforcement content (e.g. 0.1 percent steel), the transverse cracks would often open and deteriorate, causing the steel to rupture. The cracks would then effectively become working joints that filled with incompressibles resulting in additional buckling.

Shorter joint spacing has greatly reduced the amount of buckling (e.g., 15 ft for JPCP versus 30- to 100-ft for JRCP). States including Maryland, Illinois, Connecticut, Minnesota, Wisconsin, Nebraska, Georgia, Arkansas, the Illinois Tollway, and others have observed that short joint spacing of contraction joints made blowups less likely (Foxworthy 1973).

Due to the many blowups that occurred in several states with JRCP, expansion joints were installed for preventative maintenance. At least one state, New Jersey, installed expansion joints every 78 feet starting in the 1950s for their JRCP, which resulted in fewer blowups. Note that JPCP in New Jersey did not experience blowups either.

Expansion joints have played an important role in relieving compressive stresses and reducing deterioration of existing joints, reducing buckling, and protecting bridge abutments from shoving. However, expansion joints cause their own significant roughness and deterioration. Smith et al., (1987) and Snyder et al. (1989) document how the use of pressure relief joint (PRJ) have caused very serious problems for jointed concrete pavements.

With regards to Bonded Concrete Overlay of Asphalt (BCOA) pavements, joint spacing is typically short, however, blowups have occurred in these pavements. One report was received from Colorado where significant blowups are now occurring in BCOA pavements even though these BCOA have short 6- by 6-ft joint spacing. This phenomenon may be due to the fact that

many of the transverse joints do not form and thus there may be a series of 6-ft slabs connected by consecutive transverse joints that do not crack through. When a series of slabs are connected effectively creating longer joint spacings, they will expand and contract more than the smaller slabs; causing a potential risk for blowups.

Other factors that can lead to BCOA blowups include incompressibles in the working joints, thinner slabs (6 inches or less), and panel movement due to stripped HMA and/or a shear failure in the asphalt pavement (Harrington et al. 2018). The reduced friction between the bottom of concrete overlay and existing asphalt pavement due to stripping may increase joint movement, thus creating a potential for buckling. The potential remedial measures to mitigate blowups in BCOA associated with non-activated joints are listed as follow (Harrington et al. 2018):

- Design: PCC slab sizes should be appropriate for the PCC thickness with the ratio of width to length approximately 1.0 and not exceed 1.5. Scratch milling the surface of the existing asphalt pavement can provide more uniform friction between the PCC slab and the asphalt pavement.
- Construction: Cut all joints to a depth of one-third the PCC thickness (T/3). Reduce or eliminate cold weather paving for pavements less than 7-inches thick. Seal all joints. Saw cut expansion joints at specified intervals. Cut transverse joints full depth every 12 feet for pavements with low truck traffic.
- Treatment: When excessive slab movement or blowups occur, an unproven strategy that may mitigate future blowups is to saw full depth across the full width of the pavement at approximately 300-foot intervals.

### **Slab Neutral (Approximately Set) Temperature**

Slab neutral temperature is defined as the temperature at which the hardened curing concrete exhibits no tension or compression stresses. European and U.S. studies have stated that placing concrete pavements at warmer temperatures has the potential to reduce pavement blowups (Smith et al. 1987; Rens 2018). The temperature difference between the maximum temperatures in hot (future) periods and the installation neutral temperature will then be less than when the concrete was placed in a colder winter period (Rens 2018). Pavements tend to expand resulting in pressure damage when the air temperature is above the slab set temperature/neutral



temperature. Kerr and Dallis (1985) have demonstrated that pressure damage occurs at a predictable increase in temperature above the neutral temperature.

## **Weather**

Several studies have investigated the impact of hot- or cold-weather paving where researchers developed guidance (Kosmatka and Wilson 2011; Popovics et al. 2011; Kohn et al. 2003). In general, concrete pavements can be placed in hot or cold weather when considering the recommended steps. Hot weather is defined by ACI as a period when, for more than 3 consecutive days, the following conditions exist:

- The average daily air temperature is greater than 77 °F. The average daily temperature is the mean of the highest and the lowest temperatures occurring during the period from midnight to midnight.
  - The air temperature for more than one-half of any 24-hour period is not less than 86 °F.
- Cold weather is defined by ACI as a period when, for more than 3 consecutive days, the

following conditions exist:

- The average daily air temperature is less than 40 °F. The average daily temperature is the mean of the highest and lowest temperatures occurring during the period from midnight to midnight.
- The air temperature is not greater than 50 °F for more than one-half of any 24- hour period.

Limited studies have linked the time of year during which the concrete was placed to the occurrence of blowups. Michigan DOT used to require pressure relief joints for new construction of JRCP that was built in the spring or later in the year (Harrington et al. 2018). The rationale was that the thermal expansion that would occur when the pavements were subjected to temperature in excess of that experienced during construction would exceed the shrinkage due to drying; the net result being the generation of compressive stress at the joints. Constructing pressure relief joints was thought to alleviate the buildup of this stress and prevent blowups. A negative impact of this practice was the observation that transverse joints on either side of the pressure relief joint opened wider than anticipated, allowing for the infiltration of incompressible materials and resulting in loss of load transfer at those joints and the closure of the pressure relief joint.

Based on Belgium's experience Rens (2018) suggests that roads built during the warmer (summer) periods will expand less during hot periods and therefore joints will close less quickly. For ambient temperature warmer than 59 °F blowup risk is limited. For roads placed at ambient temperature below 59 °F, Rens recommends expansion joints at regular intervals (approx. 300 ft) so that pressure build-up between the concrete slabs can be relieved.

### **Dowels**

No studies have reported any evidence that links dowels to pavement blowups, however, dowel bar misalignments can lock up the joints and prevent them from opening and closing freely, which may result in the excessive opening of adjacent joints as well as spalling (chipping) and cracking near the joints (Rao 2005; Khazanovich 2009). Dowel bars are expected to provide adequate joint load transfer efficiency between slabs without restricting the horizontal joint movements due to thermal expansion and contraction of the concrete. State highways agencies specify dowel alignment tolerances to facilitate joints movement due to daily/hourly environmental loads (i.e., temperature/moisture) fluctuations.

Different types of dowels misalignments including horizontal and vertical translation were identified to evaluate their impacts on pavement performance. Vertical translation of dowels has potential impact on spalling while longitudinal translation has no potential impact on spalling. To evaluate dowel bar alignment at concrete joints, a non-destructive test such as pulse induction can be used. Factors that can impact the alignments of dowels include misplacement/displacement, basket rigidity, improper fastening of basket to the base/subbase, field inspection during construction, and paving operations.

### **Asphalt Overlay**

Over the past decades, the impact of asphalt overlays on buckling has been investigated in Indiana (Foxworthy 1973; Gress 1976). The researchers found that an overlaid concrete pavement becomes critically saturated with respect to freezing and thawing durability during the winter season. Blowup is related to moisture and thermal expansion by some complex interaction. The results of moisture data indicated that the resurfaced concrete pavement had a degree of saturation about 13 percent higher than bare concrete pavement. However, the authors concluded that the results are not definitive enough to allow quantitative measurements to be judged as an accept or reject system for evaluating a potential pavement for overlay and state that everything that reduced moisture will tend to reduce the likelihood of blowups.

## **Appendix B: Incompressibles in Transverse Joints as a Risk Factor for Buckling**

Many researchers who have studied blowups and spalling have identified incompressibles (e.g., hard rocks, sand, grit) that infiltrate into the transverse joints and cracks as a major risk factor. Incompressibles infiltrating into transverse joints cause an increase in compressive stresses in the concrete slabs. Incompressibles can infiltrate from both the top-down (roadway surface debris) and from the bottom-up (pumping of materials from the base, subbase, and subgrade). The availability of incompressibles, width of joint, and condition of the joint sealant affect the top-down infiltration. Base type and concrete durability have a major impact on the bottom-up infiltration.

The availability of incompressibles to infiltrate into the transverse joints and cracks may be a significant risk factor. For example, some highways have higher preponderance of trucks carrying aggregate such as sand and gravel that falls off and provides a source of incompressibles. Other highways are located where the wind brings incompressibles to the pavement from adjacent areas such as turf or gravel shoulders. Practices relating to the use of grit or sand for winter maintenance especially on upgrades are also a major source of incompressibles.

Stott and Brook (1968) describe the mechanism by which blowups may develop due to infiltration of incompressibles. Material infiltrates into open joints during the winter months either from the upper surface of the road, from material in the base, or from dislodged material in the joint itself. This material settles at the bottoms of the joints due to gravity. The material creates local point of contact between the opposite faces of the joints when the joints close in summer and the therefore local concentrations of compression arise which spall the joints. The spalled material is added to that already at the bottom of the joint and the process is repeated over several years with progressive spalling. After some years, the situation changes and the compression is transmitted to the relatively sound tops of slab. The relatively sound tops of the slabs present a reduced area to the compression force and an upwards eccentricity so there is a greater likelihood of blowup than in the original sound slab.

In a related phenomenon, Arizona has experienced significant pushing of bridge approach slabs and backwalls due to incompressibles infiltrated into adjacent transverse joints of JPCP. The incompressibles in the expansion joint located at bridge ends caused compression stresses. Once the expansion joints closed, they in turn pushed against the bridge backwalls resulting in

cracking in the backwalls. The transverse joints nearest the bridge ends were observed filled with incompressibles and were about ½- to 1-inch wide, whereas at further and further distances from the bridge, the width of the joint was narrower and narrower with fewer and fewer incompressibles.

Blowups cannot occur unless there is a large compressive stress increase in the concrete slab. Burke (1998) describes the critical pressure generation that builds up prior to the occurrence of a blowup. Debris infiltration of contraction joints will result in pressure generation where pavements are restrained or growth generation where pavements are not restrained. Burke states that “As both pressure and growth generation appear to be directly related to debris infiltration of contraction joints, it goes without saying that the factors that have a significant effect on pressure generation have a similar effect on growth generation.”

Burke adds that incompressibles can infiltrate poorly sealed transverse joints and cracks when they are open. The joints and cracks open widest during the colder seasons, which are also the seasons during which sand and other deicing materials are placed on pavement surfaces. These materials enter the joints and cracks and prevent them from closing during warm seasons. Incompressibles do not necessarily infiltrate from the top surface. Burke also states that intrusion can occur from below the slab when vertical movements at the joints and cracks cause pumping. Water and base material particles are forced upward into the joints and cracks. In time, incompressibles can buildup which prevents the joint from functioning properly. The result of concrete pavement “growth” (from incompressibles) is an increase in compressive stress in the slabs. When this stress exceeds the compressive strength of the slab at a given point, spalling or shattering of the slab occurs.” (Kerr and Dallis 1985).

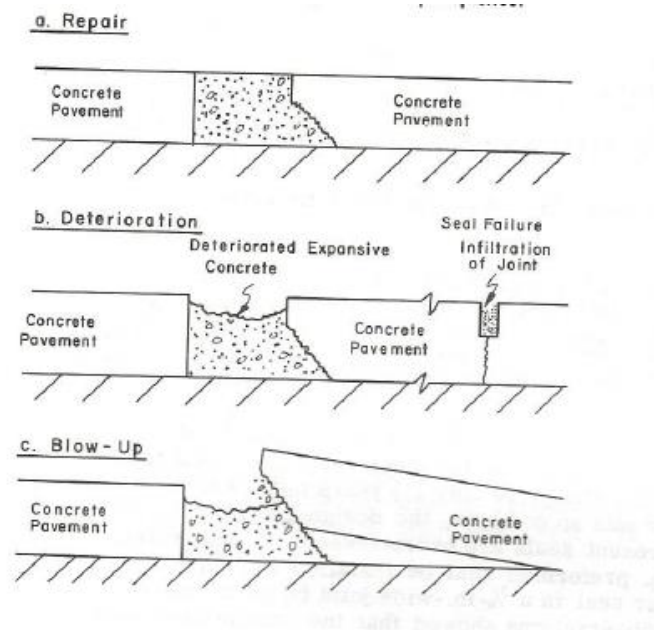
By contrast, Shober (1997) suggested that “even well-sealed joints deteriorate and become partially unsealed. He postulated that the partially sealed condition allows incompressible material to enter the joint at the discrete locations of sealant failure. When the pavement expands the expansive force is concentrated entirely at the discrete locations of the incompressibles, causing extreme stress concentrations with associated spalls and corner cracking (crows-foot cracking). Wisconsin’s unsealed joints are sawed 1/8- to ¼-inch wide and become uniformly filled with fine incompressible material except for the top 1 inch or so, which is kept clear by traffic action. According to Shober, when the PCC expands, the stress is

uniformly distributed across the entire cross section. This uniform stress amounts to 1,000 to 2,000 psi maximum, that is “well below the compressive strength of the concrete.”

### Utah Experience

Utah began constructing JPCP in the early 1960s. The design of these pavements followed similar JPCP in many western States with 12, 13, 18, and 19-ft random joint spacing, no dowels, skewed joints, filling of the transverse joints with an asphaltic material, and a cement-treated base course that bonded securely with the concrete slab.

During the summer of 1972, Utah experienced its first blowups on pavements that were 9 years of age. The initial investigation at these sites indicated that the blowups had occurred at two locations where the contractor had left transverse wooden bulkheads in-place that were laid at the end of a day’s paving (McBride and Decker 1975). These locations were later noticed and repaired as shown in Figure 41. However, the repairs were performed such that the conditions were conducive for a blowup to occur – note in Figure 41 the repair material acts as a ramp for the existing concrete pavement. About 9 years later, blowups occurred at these locations thus demonstrating how deficient construction and repair procedures can lead to buckling.



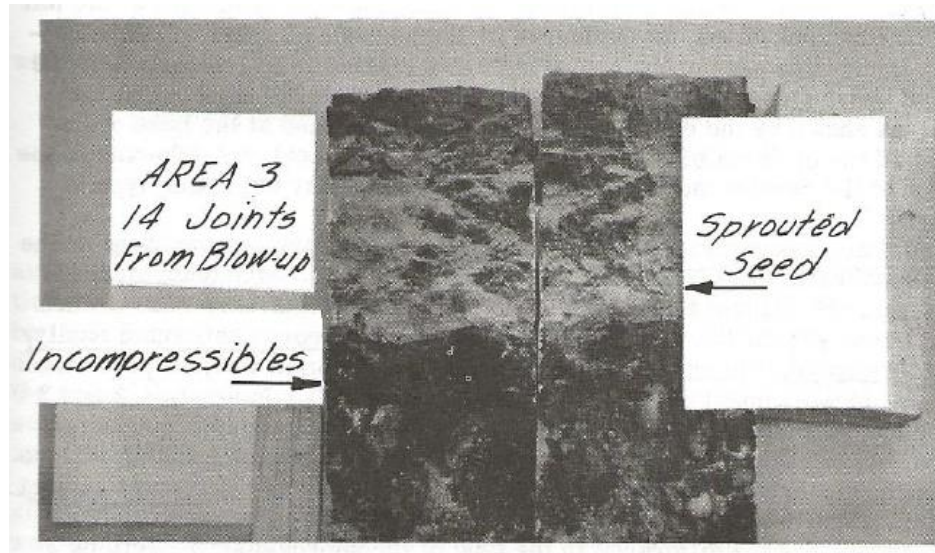
**Figure 41. Utah repair, deterioration, and buckling sequence (McBride and Decker 1975).**

These blowups led to a further investigation of six projects that ranged in age from 0.5 to 10 years. The sections were cored through the transverse joints and the amount of incompressibles assessed along with the joint conditions. Before coring, some epoxy was poured

into the joint to prevent the loss of incompressibles during the wet coring operation. The following summarizes the results from this study:

- Incompressibles were found in the adjacent joints that had opened when the blowups occurred. The cores taken in the location where the two blowups occurred revealed 3 layers of contamination (Figure 42) suggesting that a crushing action was taking place. The top contamination layer was mainly large aggregate whose size depended on the opening of the joint. The middle layer contained a fine-grained material, and coarser sandier material was at the bottom. In several cores this coarse-grained material was 0.25-inches thick and 5-inches deep.
- This buckling project area was also where both salt and sand were used as part of winter maintenance activities. The study found that more incompressibles were found in the joints in this area than in the areas where only salt was used.
- The joints that were in the area of the blowups showed the most deterioration over time (e.g., spalling) and contained the most amount of incompressibles in the joints.
- Deterioration at the slab joint bottom was detected in all but the newest pavements.
- Newer pavements showed less infiltration of incompressibles in the joints.
- The longitudinal joints in the pavement were found to be in good condition in all test sections. McBride and Decker state that movement experienced by the longitudinal joint is restricted due to the tie bars.

McBride and Decker hypothesized from the study results that during the colder months of the year, the pavement joints opened and were being infiltrated with incompressibles. They suggest that while the overall past performance of the pavements had been excellent and that at the present time, joint infiltration had not adversely affected the overall pavement performance; this may not be the case in the future, because there was evidence of spalling at the bottom of the joints. They stated that spalling in the joints is one of the steps in the mechanism for blowups.



**Figure 42. Core showing 3 layers of contamination.**

### **Nebraska Experience**

Nebraska's experience in an example of uneven infiltration of incompressibles along the transverse joint or crack resulting in spalling. A JPCP project was constructed recently along I-80 in Nebraska. The joints were filled with an asphaltic material and the project opened to traffic in the fall. After one cold winter, one hot summer, and another cold winter, the outer approximately 4 feet of the transverse joint of the tied PCC shoulder developed spalling as shown in Figure 43 (left). Closer observations showed a significant amount of incompressibles had infiltrated into the transverse joint at this outer portion of the PCC shoulder. The core shows that the joint was spalled about 1-inch deep, incompressibles were above the sealant, the sealant is 1.5-inch from the surface, and the joint is cracked and working Figure 43 (right).





**Figure 43. Spalling along the shoulder joint where incompressibles infiltrated after only 1.5-years of service on I-80 in Nebraska (left). Core taken in the spall area (right).**

## **Appendix C: Joint/Crack Spalling as a Risk Factor for Buckling**

Several research studies have concluded that joint or crack spalling is a risk factor for buckling. As such joint spalling may be considered a reasonable indicator or precursor of a future blowup at or near a joint. In addition, maintenance activity such as asphalt patching is often associated with spalling and thus may itself be a related risk factor. Several causes of joint spalling of jointed concrete pavements are identified below:

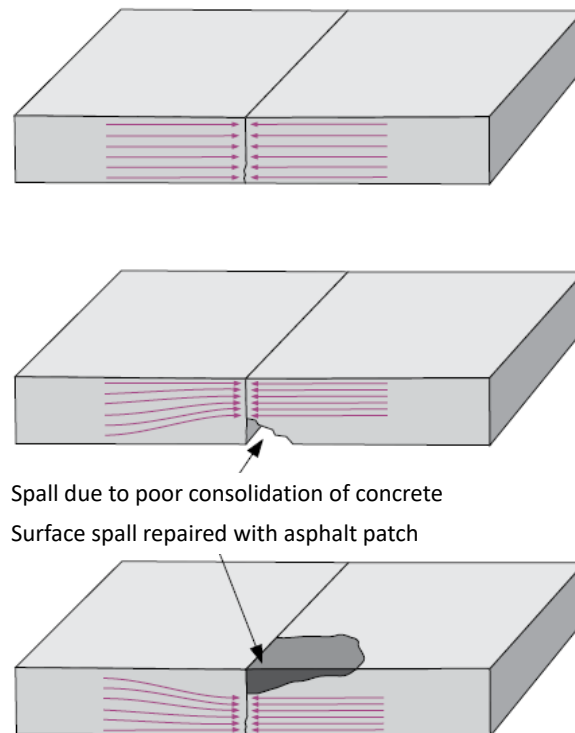
- Concrete damage caused from saw cutting too early can later develop into spalling of the transverse joint (Crovetti and Kevern 2018).
- Concrete disintegration from durability issues including “D” cracking, freeze-thaw damage, alkali-silica reactivity, etc., can result in joint and crack spalling.
- Significant misalignment of dowel bars at a joint can cause high slab stresses that may develop into spalling.
- Infiltration of incompressibles into the transverse joints and cracks mostly during cool weather cycles (Burke 1998; Smith et al. 1987; McBride and Decker 1975).

The following points to references that specifically identifies spalling as a risk factor for buckling.

- Spalling near the joints reduces the stiffness of the joints and introduces axial force eccentricities into the slabs, making them more susceptible to buckling or lift-off blowups (Kerr and Shade 1982).
- Spalling also increases the likelihood of shattered slab blowups because compressive forces must be resisted by smaller areas of concrete as spalling increases (Smith et al. 1987).
- The correlation between spalling and blowup occurrence has been verified by studies conducted in Virginia, which indicate that as many as half of the joint faces involved in blowups exhibited prior deterioration (Tyson and McGhee 1975).
- The results of a Michigan study suggest that if a transverse joint is divided into five equal length sections, the probability of a blowup occurring in the future increases greatly with the number of joint sections exhibiting spalling (Simonsen 1976).
- Variations or weaknesses in the concrete facing along a transverse joint or crack can result in variation of compressive stresses and strengths and a higher risk for buckling. For example, poor consolidation near end of day transverse joints have led to blowups in CRCP

as well as manhole covers and maintenance patching activities in JPCP in Belgium (Rens 2018).

- The result of concrete pavement “growth” (from incompressibles) is an increase in compressive stress in the slabs. When this stress exceeds the compressive strength of the slab at a given point, spalling or shattering of the slab occurs (Kerr and Dallis 1985).
- Significant variation of concrete strength along the transverse joint could cause localized excessively high compressive stress in hot and wet weather (when concrete is expanding). Partially disintegrated concrete along the joint, after spalling occurs would be even more problematic as illustrated in Figure 44. Low strength next to high strength concrete can lead to a crushing of the weaker concrete and then a blowup (Rens 2018).



**Figure 44. Illustration showing how variations in concrete facing along a transverse joint or crack can result in variation of compressive stresses and higher risk for buckling (Rens 2018).**

## **Appendix D: Literature Review – Other Agencies Experiences with Buckling**

### **Illinois**

In the 1950s, the Illinois Division of Highways conducted a study to determine the possible causes of pavement buckling (Illinois Division of Highways 1957). A database was developed to examine the factors that cause pavements to blowup. The database includes month and time of buckling, ambient temperature at time of buckling, days of last rain before buckling, location of buckling, and pavement design features. A total of 2,994 blowups were reported during the six-year study period of 1952-1957 on 11,420 miles of pavement made up of 3,368 construction sections. Of these, a total of 141 blowups were reported to have occurred in an asphalt overlay of the concrete pavement. The occurrences of pavement buckling are summarized below:

- 90 percent of all blowups occurred when the air temperature was equal to or greater than 90 °F.
- 73 percent of blowups occurred in the month of June and 17 percent of blowups occurred in May.
- 75 percent of all blowups occurred within a week following a rainfall event.
- 85 percent of all blowups occurred between 1:00 and 6:00 P.M.

No correlations were found between the occurrence of blowups and coarse aggregate sources, fine aggregate sources, cement, subgrade soil types, and the presence of granular base. Based on the findings of this study, no recommendations were provided to the Illinois Division of Highway to alter designs or materials source.

### **Indiana**

The primary objective of this study was to evaluate the effect of an asphalt overlay of concrete pavement (JRCP) on the incidents of buckling in Indiana. A statewide survey of resurfaced concrete pavement and laboratory and field testing were conducted to examine all factors that correlate with buckling (Foxworthy 1973). The survey database includes a cumulative total number of blowups for each mile, pavement design, base type, original pavement age, coarse aggregate, subgrade type, shoulder type, first overlay age, and drainage characteristics. The data collected from the survey was analyzed to identify the major factors that influence buckling activity. The key findings of the statewide survey are summarized as follows:

- Pavements with short joint spacing had reduced frequency of buckling compared to long joint spacing. Although the changes in design over the years, from 80 ft. to 40 ft. joint spacing, have reduced the severity of buckling activity, it didn't completely eliminate buckling.
- The age of the original concrete pavement correlated with buckling. Pavements up to 40 years old showed a trend of increasing buckling, while pavements over 45 years old didn't show a consistent trend for high or low frequency of buckling.
- The inclusion of a granular base underneath concrete pavements (as compared to no base) has contributed towards reducing blowups. Based on the findings, the Indiana state highway altered its pavement designs to include a granular base for concrete pavements.
- The type of coarse aggregates used in concrete pavements were investigated. There was no solid conclusion drawn from the effect of aggregate sources on pavement buckling. Crushed stone showed slightly better performance than gravel, however, no significant differences existed among aggregate types in buckling occurrences.
- Pavement buckling occurred more frequently in the northern districts than the southern districts of the state. The districts in the northern areas used heavy sand and salt during winter maintenance to melt ice and snow accumulated on paved surfaces. The use of sand and salts potentially lodged in the joints and accelerated the disintegration of concrete pavements.
- Paved shoulders significantly reduced the incidents of buckling compared to gravel or turf shoulders.
- Pavement buckling started to occur in an early age after placing an asphalt overlay on concrete pavements and dramatically increased between three to five years of the overlay's age. The thickness of overlays was not a significant factor on buckling activity.

Gress (1976) documented the second portion of the Indiana study; the laboratory and field investigation of resurfaced concrete pavements. Instrumentation sensors (i.e., temperature, moisture, and deformation) were used to monitor the performance of pavements with and without an asphalt overlay. Moisture sensors were placed at different depths of the pavement to measure moisture variation through the depths. The analysis of moisture data indicated that the

resurfaced concrete pavement had a degree of saturation about 13 percent higher than the bare concrete pavement.

### **Ohio, Michigan, New York, Wisconsin (All old long JRCP)**

Burke (1998) discusses in length the phenomenon of pavement pressure generation, that is “responsible for most of the serious pavement and highway bridge damage that has taken place in the last several decades” and that “[blowups] are unmistakable indications of high pavement pressures.” Burke also discusses a series of Wisconsin research papers, wherein the engineers of the Wisconsin Department of Transportation preached the use of unsealed contraction joints. Burke criticizes the research harshly and states “. . .it appears that results of Wisconsin’s research are inconclusive since there was no attempt made to monitor and report about the relative magnitude of generated pavement pressures for both the sealed and unsealed pavement test sections. Consequently, joint sealing recommendations coming from this research are of questionable validity.”

In the same publication, Burke summarizes some history of buckling from the 60s and 70s as follows:

- Based on a count of blowups in 11 districts in Ohio, Burke estimated that there were in excess of 500 blowups in Ohio in 1970.
- During the late 1960s and early 1970s, Burke states that Michigan reported 1,000 or more blowups a year and that a bulletin of the Associated Press in Detroit contained a report stating that in 1971, Michigan experienced 1,387 blowups in the month of June alone.
- Burke also states that New York is reported to have experienced 1,590 blowups in one year with most of them occurring on the same day, July 3, 1966.
- Burke points to a 1970 article in the Milwaukee Journal contained an interview with Mr. Charles R. Ryan, the Chief District Maintenance Engineer for the eight counties in southeastern Wisconsin who is quoted as saying: “During the last two weeks more than 200 sections of road have blowups, and many more are under stress and are ready to blow.”

## **Appendix E: Research Team Interviews – Other Agencies Experiences with Buckling**

### **Minnesota**

Only a small number of blowups have been reported in the past few years. It appears that the most active areas of buckling are on long-paneled JRCP. Minnesota built 39-ft JRCP many decades ago and those are typically the worst. Minnesota also built 27-ft JRCP for a few years and those are “not as bad.” Minnesota then changed to 15-ft JPCP and blowups are not much of an issue. Typically, the most active period is when it gets hot after a good bit of rain has fallen. There may be more blowups on the concrete pavements that have been overlaid with asphalt. The asphalt overlaid concrete pavements don't seem to blowup as badly as the plain concrete pavements, but they tend to blowup more frequently.

### **Arizona (Scott Weiland, Arizona DOT)**

Arizona began constructing short jointed JPCP with sealed joints many decades ago and have not experienced any problems with blowups over at least the past 25 years. Many of Arizona's urban JPCP have been overlaid with 1/2-inch thick asphalt rubber surface course and these projects have not developed blowups either. In the 1970's, Arizona had some serious infiltration of sand into the joints near bridge ends which pushed the approach slab into the bridge backwall resulting in cracking of the concrete backwall. The transverse joints nearest the bridge ends were found to be filled with incompressibles and were about 1/2- to 1-inch wide, whereas at further and further distances from the bridge, the width of the joint was narrower and narrower with lesser and lesser incompressible materials.

### **Iowa (Chris Brakke, Iowa DOT; Gordon Smith, National Concrete Pavement Technology Center at Iowa State University)**

Iowa does have buckling on both JPCP and the old 1920s-40s designs (which were variations of thickened edge JRCP with some longitudinal steel (2-3 strands in the thickened part and some also had a few strands in the remainder of the lane). On I-235, prior to the reconstruction project, there were blowups each summer and that was a JPCP. Generally, Iowa has blowups on pavements with D-cracking aggregates that were overlaid with HMA. No blowups have been observed on CRCP. Iowa uses early entry saws and has been filling joints since the early 1990s. Prior to the 1990s, Iowa used backer rod and sealed the joints. In a typical year, Iowa DOT maintenance equipment operators spend 2,000 to 4,000 hours performing temporary repairs of pavement blowups and another 6,000 hours replacing these



pavement sections, costing an average of \$400,000 annually (Harrington et al. 2018). Many of the blowups only result in a spall, pothole or small chunks of concrete lying around the pavement joints. Concrete durability problems such as “D” cracking has contributed to weakening the concrete near joints adding to the risk for buckling (Harrington et al. 2018). Over the past 10 years Iowa has some accelerated deterioration of joints in composite pavement (concrete pavements overlaid with asphalt) due to the use of deicing brine. Many pavements have joints that heave in the winter and summer due to deteriorating concrete.

### **Illinois**

Illinois built JRCP with very long 100-ft joint spacings many decades ago and these projects developed many blowups at transverse joints and at deteriorated transverse cracks where the steel had ruptured. “D” cracking and other concrete disintegration has been a major factor in the loss of concrete strength at transverse joints and cracks. Illinois began building CRCP in 1960s with many projects since then and there have been several blowups per year develop specifically where transverse steel ruptures occurred, and the resulting transverse crack was not repaired with a reinforced concrete full depth repair. The ruptured wide transverse CRCP crack would usually be filled with bituminous materials and often this location would eventually experience a blowup. Blowups also occurred where an asphalt full depth repair was made over about half the lane width. Full lane width blowups would sometimes occur where multiple lanes were tied together. Most of the occasional blowups on CRCP were caused by deficient maintenance procedures. Blowups have not developed significantly in JPCP, which has been constructed in Illinois since the 1990s.

### **Illinois Tollway**

The Illinois Tollway has constructed JRCP since the 1950s. These long-jointed pavements developed many blowups over time, even with expansion joints placed every 1,000 feet. The Illinois Tollway started building JPCP with 20-ft joint spacing and sealed joints in the late 80’s and moved to 15-joint spacing in the 2000s. They have not experienced any significant blowups over this time period with JPCP. The same goes for CRCP, which the Illinois Tollway has built since the early 2000s and no blowups have occurred for CRCP. The Illinois Tollway uses asphalt treated bases beneath the concrete slabs, which have higher friction than aggregate base courses, resulting in reduced joint openings. The Illinois Tollway has experienced some

cracking in pavement transitions between the CRCP and the JPCP. The details for this transition have been changed to address this cracking.

**Utah (David Holmgren, Utah DOT; Pat Nolan, Portland Cement Association)**

Utah has built JPCP with random joint spacings of 12, 13, 18, 19 ft since the 1960s and have experienced about 6 to 8 blowups per year in recent years. Utah fills all their transverse joints with asphaltic material at construction but has not maintained them afterwards. Spalling of transverse joints and a few blowups have occurred especially on upgrades where salt and sand were used for deicing. All base courses in Utah are stabilized with cement or asphalt and bonded to the slabs which reduces the joint opening about 35 percent as compared to aggregate bases. One recent unusual JPCP project on an uphill grade had an unbound aggregate base course and dowels. This section developed about 1-2 blowups per mile within 8 years of construction. The unbound aggregate base would allow the joints to open and close much more than a stabilized base on other Utah highways. Lots of sand and salt was placed for winter roadway maintenance, which appears to have infiltrated into the transverse joints contributing to the blowups. In addition, this JPCP is located near a major gravel pit and there are a lot of gravel trucks on this section.

Pat R. Nolan on the Utah experience stated: “If joint seals are effective such that sand and other incompressible materials do not infiltrate the joints, the contraction joints will easily provide for temperature expansions. Buckling problems have been nearly nonexistent in pavements with short joint spacing (less than 20 feet) with sealed joints. Blowups are much more common in pavements utilizing mesh dowel design with joint spacing of 40 feet or more.”

The following represents the research team’s comments based on interviews with DOTs and personal experiences with buckling, specifically in Utah.

- One reason for lower blowups in Utah as compared to Wisconsin may be due to the fact the concrete slabs in Utah have higher durability as compared to concrete slabs in many mid-western States, where there have historically been significant durability issues due to higher moisture, higher number of freeze thaw cycles, and concrete mix design factors. Less durable concrete at or near the transverse joints is inherently weaker resulting in an increased risk of buckling.
- A second reason may be that nearly all the JPCP in Utah have stabilized base courses (cement-treated, asphalt-treated, lean concrete), which provides a high friction interface

restricting the opening and closing of the joints as compared to unbound aggregate bases. Measurements indicated that joint opening for JPCP on unbound aggregate base was 20 percent more than on cement-treated base.

- In Utah, joints are narrowly sawed with a single saw blade and then filled with an asphaltic material. While this material is not very durable and if often over stressed, it contributes to a reduction in incompressibles infiltrating into the joints.
- Increased spalling of transverse joints does typically occur in JPCP in Utah after many years and particularly on upgrades where sand or grit and salt are used during the winter. These areas have experienced higher frequency of buckling. For example, one JPCP that was placed over an unbound aggregate base course on US89 south of Ogden on a steep grade, developed several blowups within 8 years.
- The availability of incompressibles to infiltrate into the transverse joints and cracks seems to be a factor impacting buckling. Some highways are filled with trucks carrying aggregates and sand and gravel that provides ample incompressibles. Other highways are located where the wind brings ample incompressibles to the joints and cracks. Some highway agencies use grit or sand for winter maintenance especially on upgrades. This occurred on at least two upgrades in Utah (US-89 and I-15) where sand and grit incompressibles infiltrated transverse joints resulting in spalled joints followed by blowups several years later.

## **California**

California has built JPCP for many decades and has not experienced many blowups. Most of California pavements are in temperate climates with less difference between summer and winter pavement temperatures as compared to the upper midwestern States including Wisconsin. Many JPCP in California were constructed using plastic tape to form the joints without any sealant. Other JPCP were sawed with a single saw cut and no sealant placed in the joints. Yet other had an asphaltic material poured into the sawed joint. All the California JPCP have treated bases so joint opening are less as compared to unbound aggregate bases. More recently, about twenty CRCP have been constructed with an asphalt-treated base and no blowups have occurred on these pavements.

## **Washington/Oregon**

Washington has built JPCP for decades. Oregon has JPCP as well as lots of CRCP. Buckling is uncommon in these States and the industry representative rarely hears about one.

## **Georgia**

Georgia built 30-ft joint spacing pavements in the 1960s and 1970s and then shortened to 20 feet JPCP. Georgia had a few blowups in the early years (1960s) but in the early 1970s, Georgia DOT placed a lot of emphasis on joint sealing and joint maintenance. Blowups did not occur following the 1970s and as far as is known they still do not occur on a regular basis, and probably “less than one or so in a typical year.” Georgia has built CRCP but had no blowups on this pavement type.

## **Colorado (Angela Folkestad, American Concrete Pavement Association – Colorado/Wyoming Chapter)**

Colorado has built only JPCP with short joint spacings. Colorado seals all joints with silicone sealant during initial construction. JPCP in Colorado have experienced some blowups over time, particularly on the short jointed bonded concrete overlays of asphalt (BCOA) which have been built since the 1990s. These concrete slabs are only 6-inches thick, which makes them more susceptible to buckling even though the concrete slab is well bonded to the underlying asphalt pavement. However, some of the transverse joint saw cuts do not crack through the slabs resulting in potential locations where multiple slabs act as one long slab in terms of joint opening and closing, thus contributing to buckling.

## **Europe (Luc Rens, EUROPAVE)**

Countries in Europe have constructed short jointed JPCP (15- to 20-ft joint spacing) and CRCP for many decades. European countries did not construct many long jointed JRCP, and thus avoided the risk of developing many blowups associated with JRCP. In 1992, during the U.S. Tour of European Concrete Highways, buckling was not mentioned as a significant problem (Darter 1992).

European practices differ in terms of whether transverse joints are sealed or left unsealed and the type of sealant used. Most countries seal both transverse and longitudinal joints. An exception to this practice is Austria, where, in some areas, single 0.1-in saw cuts are used to form the joints which are left unsealed. Spain seals transverse joints in wet areas but not in dry areas.

Buckling has occurred and continues to occur in various European countries during the hot summers, but they are a relatively rare occurrence. For example, Belgium experiences roughly 10 blowups per year although they have an extensive network of JPCP and CRCP. One big problem in Belgium are damaged slabs such as cracked slabs and provisionally repaired corner breaks. Repairs on local roads are often done with asphalt in a provisional manner and a permanent repair follows some years later, and sometimes never at all. These are weak points in JPCP that can often lead to buckling. Belgium has had several blowups in CRCP in the past and still have a few today. Almost all of them are located at transverse construction joints, the weak points in CRCP, and are often related to poor construction.

Germany has constructed an extensive network of JPCP with a few CRCP. Germany has experienced quite a lot of blowups in the past few years. As a result, they have started studying the problem and taking measures such as continuous monitoring of joint movement on some motorways. When the risk is high, they set a speed limit on the motorways (50 mph).

According to Mr. Rens (Rens 2018 and interview) there are several circumstances in Belgium and Germany that cause the risk of blowups to increase or decrease:

- Temperature at installation: When the concrete is placed in a warm summer period there will be less risk of blowups. The temperature difference between the maximum temperatures in hot (future) periods and the installation temperature will then be less than when the concrete was placed in a colder winter period.
- Period of the year (where most blowups occur): Blowups usually occur the period end of April-July. This is not only the period during which the chance of heat waves is the highest, but it is also the period of the year during which the days are the longest. There is therefore one longer duration of warming up of the pavement surface by the sunshine resulting in higher temperatures in the pavement. Moreover, the concrete often still contains a lot of water at the end of spring. As such, concrete pavements in these months experience high temperatures and high moisture content.
- Period of the day: Blowups occur in the afternoon, usually between 3 pm and 6 pm when the sun has had a long time to heat the pavement surface.
- Concrete thickness: Pavements with smaller thickness (or cross section) are more sensitive to blowups. The risks are even greater in the case of pavements installed with variable thickness.

- Wear / maintenance: Aging of the road surface and / or a lack of necessary maintenance may also be a factor. Over the years, poorly maintained joints get filled with incompressibles, especially in the cold periods when they are more open. When the joint filler has disappeared from the joints and not renewed, this phenomenon is exacerbated.
- Influence of asphalt overlay: when the concrete is overlaid with asphalt the road looks new again. But often defects are hidden in the concrete and remain as potential risks. Moreover, the black surface of the asphalt ensures that the road surface absorbs more heat and that the temperature in the concrete will rise, which increases the risk of blowups.

A few specific suggestions relative to reducing or eliminating blowups from occurring follow (Rens 2018 and interview):

- Weak spots in the slab: There can exist certain weak spots across a slab that can lead to an overstressed slab location enough to cause a blowup on hot and wet days.
- Discontinuities: Discontinuities such as built-in manhole covers create a potential weak spot at a location across the slab that could result in higher compression stresses and increased risk of blowup.
- Construction joints: Transverse construction joints sometimes exhibit poor consolidation near the joint at the beginning of and at the end of each day of paving that leads to localized weaker concrete and thus increased risk for blowups. Lack of uniformity along the concrete slab can lead to greater localized compressive stress. As such, it is necessary that the last and first several feet of the concrete paving be properly consolidated with manually operated vibrating needles.
- PCC thickness: Limited thickness (less than 7 inches) PCC makes slabs more sensitive to blowups. Some JPCP have been constructed with a thickness of 6 inches on top of an old concrete pavement and a new intermediate layer of asphalt. The limited thickness makes the slab more sensitive to buckling compared to thicker PCC.
- Asphalt patches: If local damage occurs (broken slabs, corner cracks, punch-out with continuous reinforced concrete) it should be restored as soon as possible in a permanent manner. Provisional repairs with asphalt form weak spots because they are more compressible than the adjacent concrete and cause stress concentrations in the remaining concrete and increases the risk of blowups (Figure 45).

- Concrete slabs replacement: Slab replacement must be carried out over the entire width and the entire thickness of the concrete slab and the length must be at least 6 feet. Moreover, the remaining parts of the slab must still be at least 6-feet long. The parts of plates to be reconstructed should be rectangular. The slabs should be cut over their entire thickness and width. The cuts should be perpendicular to the road surface. Slab replacement should be performed in cooler weather.
- Construction temperature. Roads built during the warmer summer periods will expand less during hot periods and therefore joints will close less quickly. For concrete paved under ambient temperature warmer than 59 °F, blowup risk is limited. For concrete paved under ambient temperature below 59 °F, expansion joints are recommended at a regular distance (approx. 300 ft) so that pressure build-up between the concrete slabs can be relieved.
- The few maintenance needs that concrete pavements require, specifically sealing the transverse and longitudinal joints, must be performed correctly and carried out on time. Figure 46 show examples where poor maintenance contributed to blowups.



**Figure 45. Buckling caused by HMA patching (Rens 2018).**





**Figure 46. Buckling caused by poor joint sealing (Rens 2018).**



## Appendix F: Neighboring Agency Practices and Designs

### Iowa

#### *Joint Design*

Iowa DOT provides jointing guidelines for different joint types used in a jointing plan. The goals of joints are to control cracking, accommodate slab movements due to environmental loads, reduce curling/warping stresses, and provide load transfer. In 2019, a policy change was made to change 20-ft. transverse joint spacing to 17 ft. to reflect the following: “transverse joint spacing should be limited to 24 times the slab thickness for slab placed on subgrade and granular base or 21 times the slab thickness for slab placed on stabilized subbase, existing concrete, or asphalt.” Spacing requirement of transverse joint is 12 ft. for slabs 6 in. thick, 15 ft. for slabs 7 to 9 in. thick, and a maximum of 17 ft. for slabs over 10 in. thick. Figure 47 and Figure 48 show standard transverse and longitudinal design layout. Iowa DOT specification identified four types of joints (Iowa DOT 2015). These types include transverse contraction joints, construction joints, longitudinal joints, and isolation and expansion joints.

- Standard transverse contraction joints spacing is 17 ft. for doweled contraction “CD” joints and 15 ft. for plain contraction “C” joints. Plain contraction relies on the aggregate interlock for load transfer and used for local street and minor collectors. Typically, plain contraction joints are used when the PCC slab is less than 8 inches thick and joint width and depth are  $\frac{1}{4}$  inch and  $1\frac{1}{4}$  inch, respectively. Doweled contraction joints are sealed and sawed to a depth of one third the PCC thickness ( $T/3$ ). Doweled joints are used when a slab is over 8-inch thick and where pavement carries more than 100 trucks per lane per day.
- Construction joints are installed at the end of the day paving operation, or construction interruptions, or widening a pavement. Longitudinal joints are typically installed at the location of a planned joint and transverse joints are typically located between transverse contraction joints.
- Longitudinal contraction joints are typically sealed; however, sealant is not required since longitudinal joints are tied and may not open. The depth and width of sealed joints are  $T/3$  and  $\frac{1}{4} \pm \frac{1}{16}$  inch respectively. The width of the joint is  $\frac{1}{8} \pm \frac{1}{16}$  inch for unsealed joint.

General jointing guidelines list to follow when designing a jointing plan for concrete pavement are provided by Iowa DOT specifications and are listed in order of importance. The list includes:

- Joints should be at least 2 ft. long,
- Ninety-degree angles are preferred,
- Pavement width should be kept through a project,
- Longitudinal joints are spaced at lane pavement width of 12 ft.,
- Maximum spacing of doweled transverse joints is 17 ft., and plain joints is 15 ft.,
- Number of joints intersecting at one point should not exceed four,
- A minimum spacing of 12 ft. transverse joints should be used,
- Avoid unnecessary angles and bends in the length of a joint.

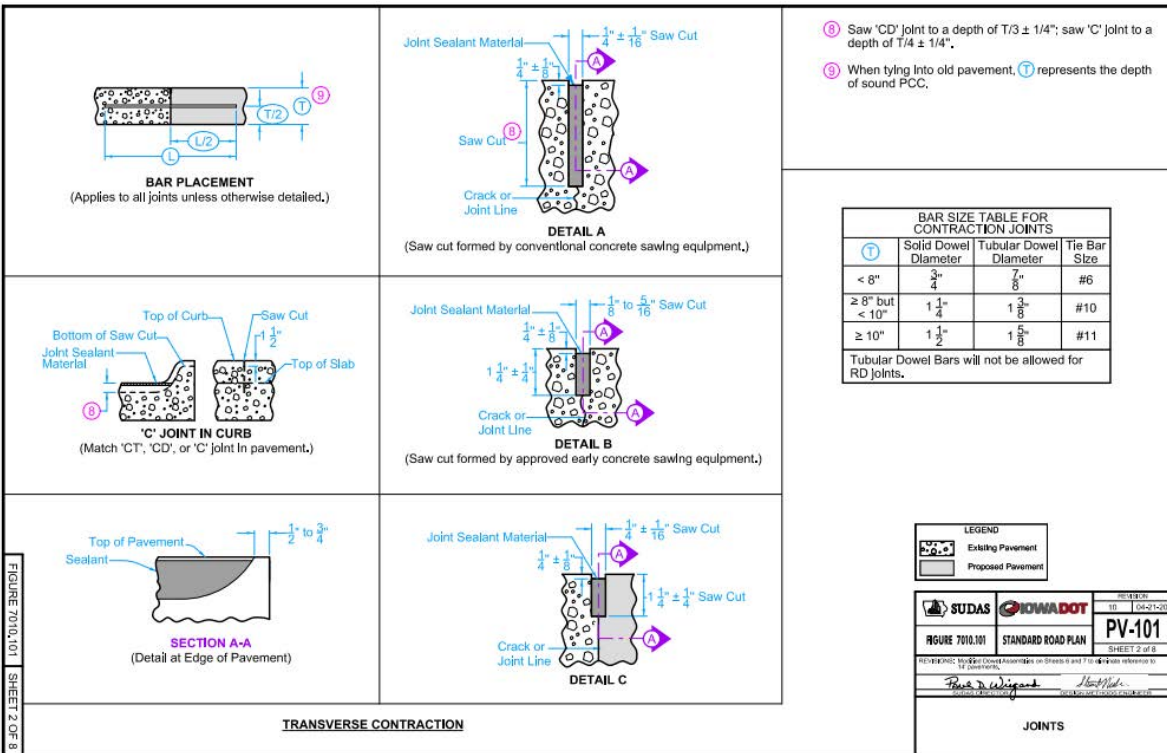
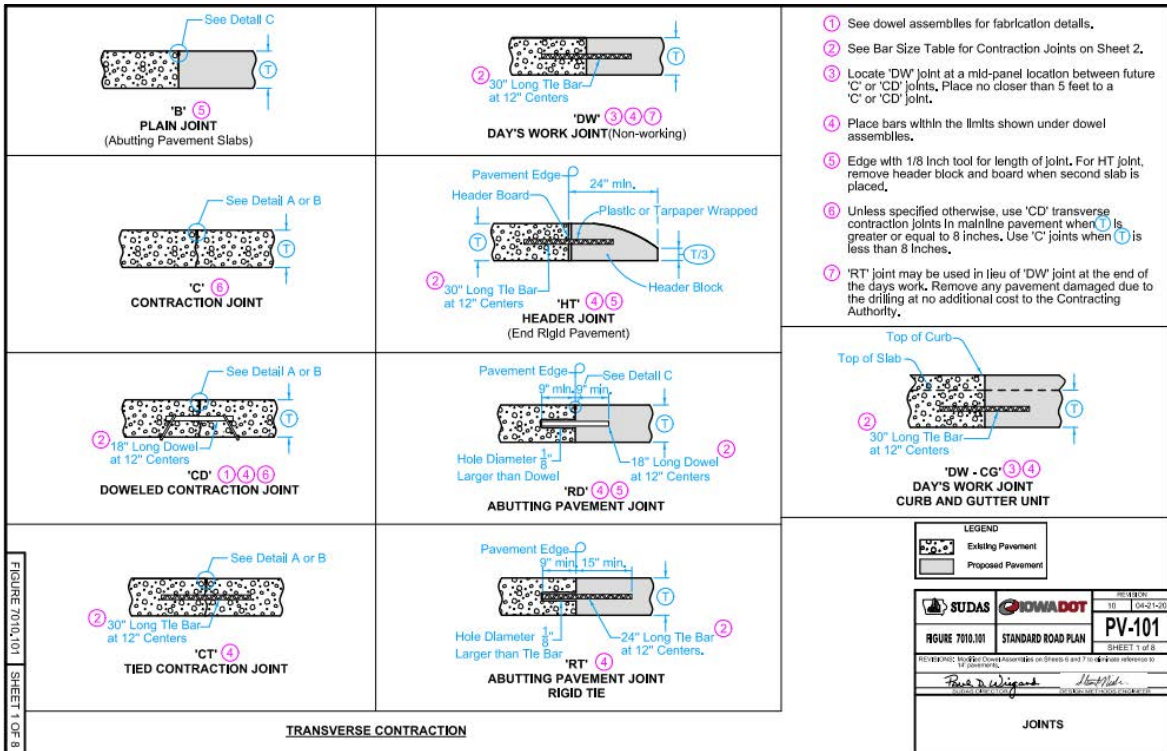


Figure 47. Transverse contraction joint design layout (Iowa DOT 2020).

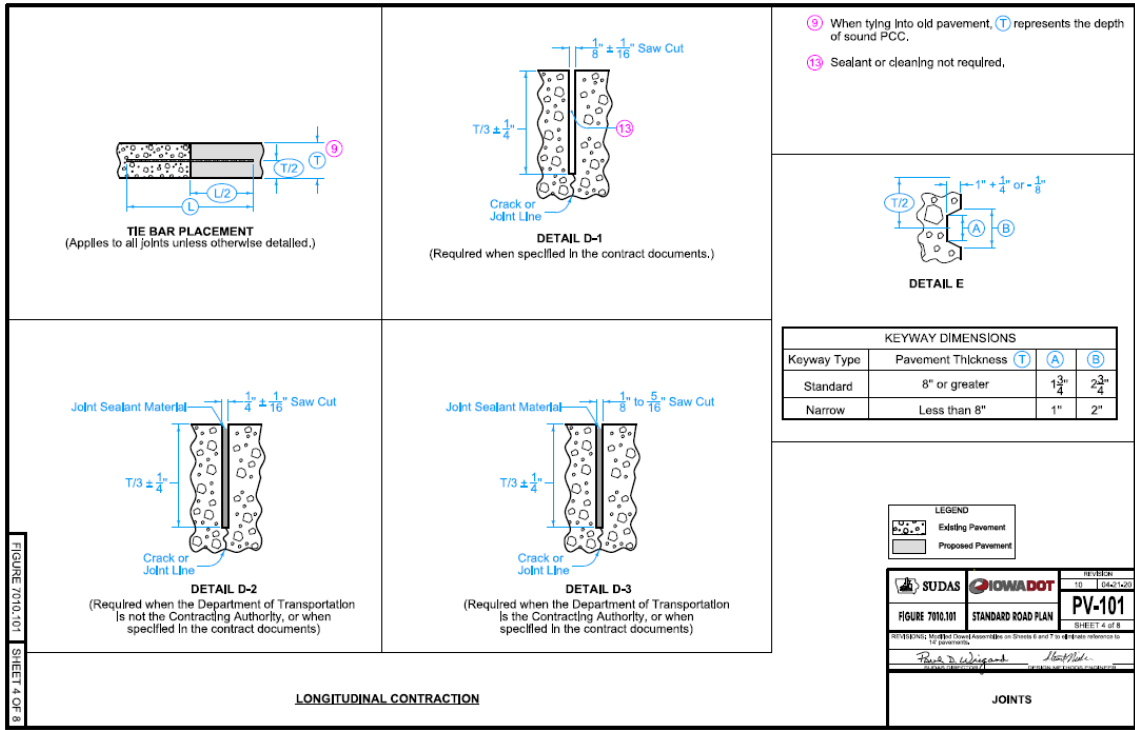
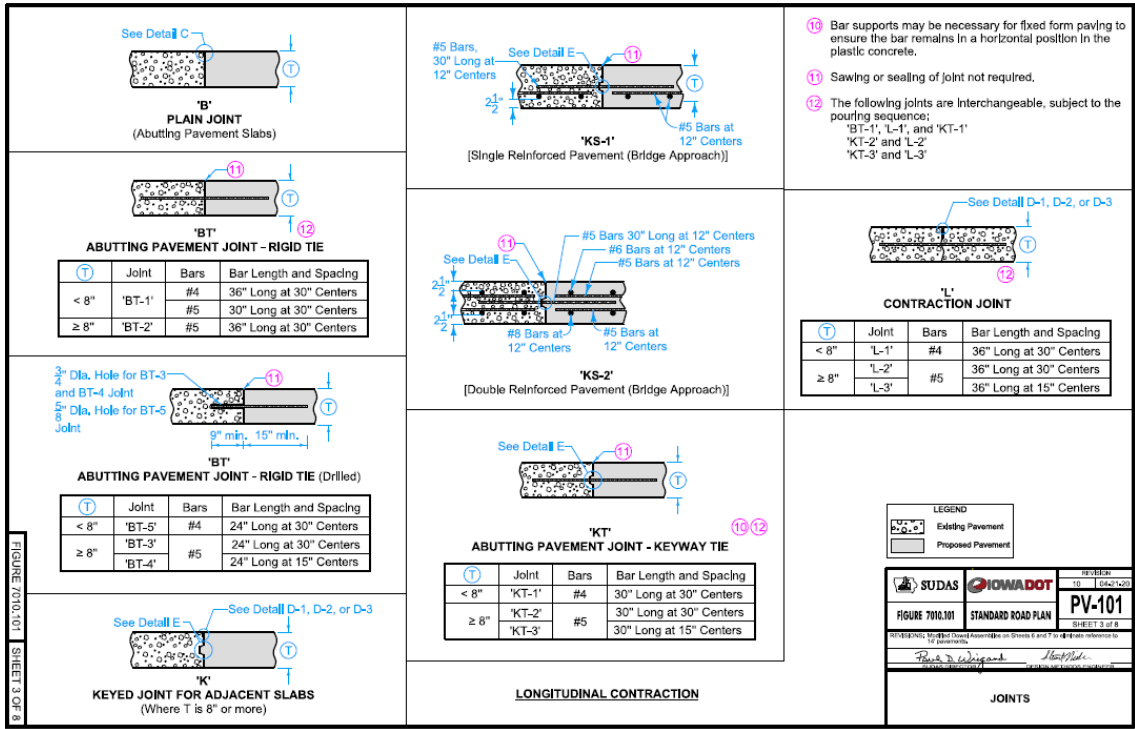


Figure 48. Longitudinal contraction joint design layout (Iowa DOT 2020).

Iowa DOT specifications requires dowel bars when PCC slab is over 8 inches thick. The dowel bars diameter and length depend on the pavement thickness as shown in Table 11. Dowel bars are typically spaced at 12 inches. Smaller dowel diameter may be used for thinner slabs.

**Table 11. Dowel bar size and length (SUDAS 2021).**

<b>Pavement thickness (inches)</b>	<b>Dowel Size (diameter in inches)</b>	<b>Dowel Length (inches)</b>
8	1 ¼	18
9	1 ¼	18
10	1 ½	18
11	1 ½	18
12	1 ½	18

*Maintenance and Rehabilitation Treatments*

Traffic and environmental loads, material problems, construction problems, joint deterioration, and moisture or incompressibles penetration through crack/joints are the typical source for concrete pavement deterioration. Iowa DOT specification and Iowa Statewide Urban Design and Specifications (SUDAS) identify several preventive maintenance treatment types to correct concrete pavement distresses as shown in Table 12.

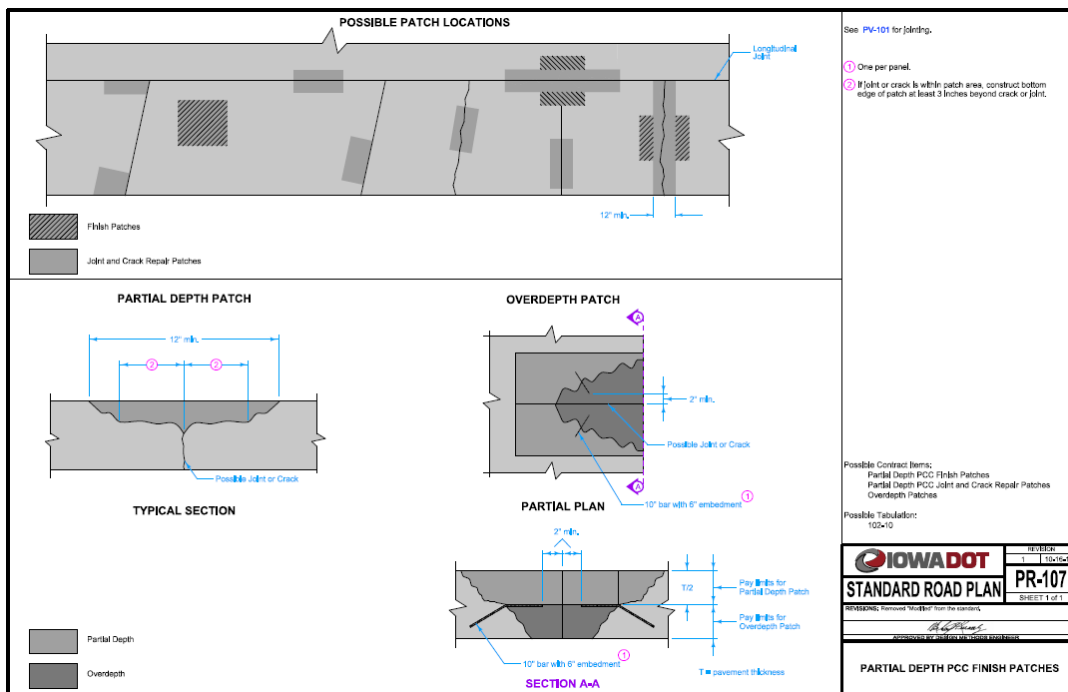
**Table 12. Maintenance and rehabilitation for concrete pavement (SUDAS 2021).**

<b>Maintenance treatment types</b>	<b>Life (years)</b>	<b>Purpose</b>
Crack sealing	4 to 8	reduce moisture intrusion
Joint resealing	4 to 8	minimize moisture and incompressibles into joint and subbase/subgrade
Partial depth patches	5 to 15	address spalling and surface scaling
Full depth patches	10 to 15	address typical PCC distress including deteriorated joints, cracks, and buckling
Dowel bar retrofit	N.A	method of load transfer restoration
Diamond grinding	5 to 15	improve ride quality
Pavement udersealing/stabilized	5 to 10	restore support beneath PCC slabs
Pavement slab jacking	N.A	correct localized settlement areas
Concrete overlays	15 to 20	eliminate surface distresses

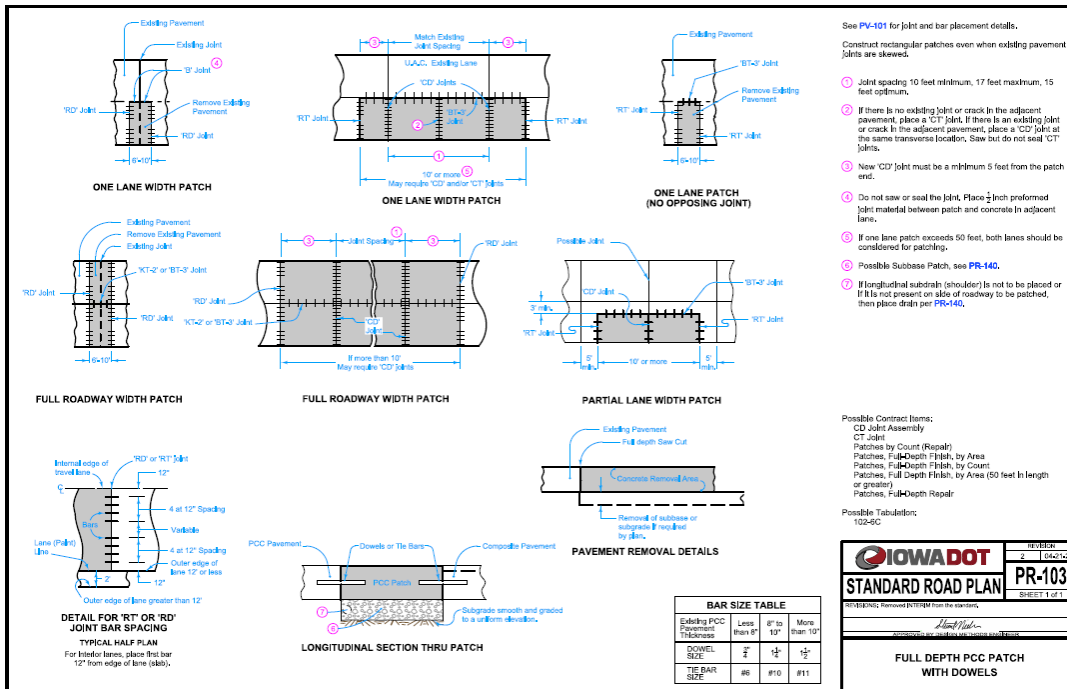
Proper guidelines to restore joint deterioration including selecting the right concrete mixture, key elements of construction partial depth patches and full depth patches were provided in Iowa DOT specification and Iowa Statewide Urban Design and Specifications.

Iowa DOT specification describes three types of patches and construction guidance for partial depth patches. Patches types include finish patches, joint and crack repair patches, and overdepth patches (Figure 49). All patches are square or rectangular in shape. Patches concrete materials identified by Iowa DOT including rapid-setting concrete and high early strength. Lifts should not exceed 3 inches in thickness with top lift 2 inches or less. Minimum removal depth should be 1½ inch and the maximum is 1/3 of slab thickness. If the required depth to sound concrete exceeds 1/3 of the slab thickness, a full depth patch is constructed.

Full depth patches with dowels apply for concrete pavement including composite sections of resurfaced concrete pavements. Figure 50 shows the Iowa DOT standard full depth patches with dowels. Full depth patches are used when joint deterioration cannot be restored using partial depth patches. Patches types are specified to be consistent with the existing pavement. Iowa DOT specification identifies several patch types including full depth patches with or without dowels. Concrete mixture with high early strength is specified to be used for patch materials to allow early opening to traffic.



**Figure 49. Partial depth PCC finish patches Iowa DOT standard (Iowa DOT 2020).**



**Figure 50. Full depth PCC patches with dowels Iowa DOT standard (Iowa DOT 2020).**

### Subsurface Drainage

Iowa DOT design manual specification for pavement drainage and strength layers provides the following guidance on the use of drainage layers. Drainage layer includes a permeable granular layer and a subdrain. Granular materials are either granular subbase or modified subbase. Granular subbase is typically used under concrete pavement and modified subbase is used under asphalt pavement or when the base needs to be driven on during staging and/or paving. The drainage layer is located under the pavement. Drainage with longitudinal subdrains is mandatory with granular subbase and modified subbase, but not with special backfill. The location of strength layer relies on the material being used. The most typical material that provide strength is Select backfill. Modified subbase or special backfill can be used as a strength layer. Polymer grid may be used to provide strength and is placed above the soil subgrade.

Recently, field and laboratory investigations were conducted to evaluate interstate pavement subdrains in Iowa on pavement surface distresses (Ceylan 2013). The cause of improper design, construction, and maintenance of subdrains were identified. It was found that moisture-related distresses were observed near blocked drainage outlet locations at asphalt pavement than concrete pavement. Clogged drainage outlets may exacerbate the development of

moisture related distress in asphalt as compared to concrete pavement. The study showed that about 35 percent of outlets in JPCP and 60 percent in asphalt pavement were not blocked. Shoulder distresses in concrete pavement were observed near blocked drainage outlets. Ceylan suggested that recycled concrete should not be used as base/subbase material due to tufa formation that cause drainage outlet blockage in concrete pavement.

*Cold Weather Concreting*

The following represents Iowa DOT’s specifications for cold weather concreting (Iowa DOT 2015):

Section 2301. Portland Cement Concrete Pavement, Cold Weather Protection.

- a. Apply cure to all concrete pavement, including exposed edges of the slab, prior to applying protection.
- b. Protect concrete pavement less than 36 hours old as shown in Table 13.

**Table 13. Concrete pavement protection requirements (Iowa DOT 2015).**

<b>Night Temperature Forecast</b>	<b>Type of Protection<sup>(a)</sup></b>
35°F to 32°F	One layer of burlap for concrete.
31°F to 25°F	Two layers of burlap or one layer of plastic on one layer of burlap.
Below 25°F	Four layers of burlap between layers of 4 mil plastic, insulation blankets meeting the requirements below, or equivalent commercial insulating material approved by the Engineer.
<p>(a) Protection shall remain overnight the first night covering is required. After the first night of covering, protection may be removed when one of the following conditions is met:</p> <ol style="list-style-type: none"> <li>1. The pavement is 5 calendar days old.</li> <li>2. Opening strength is attained.</li> <li>3. Forecasted low temperatures exceed 35°F for the next 48 hours.</li> <li>4. Forecasted high temperatures exceed 55°F in the next 24 hours and subgrade temperatures are above 40°F.</li> </ol>	

- c. When insulation blankets are used, use blankets consisting of a layer of closed cell polystyrene foam protected by at least one layer of plastic film, rated by the manufacturer with a minimum R-value of 1.0.
- d. Shut down paving operations in time to comply with protection requirements outlined above. The cover may be temporarily removed to perform sawing or



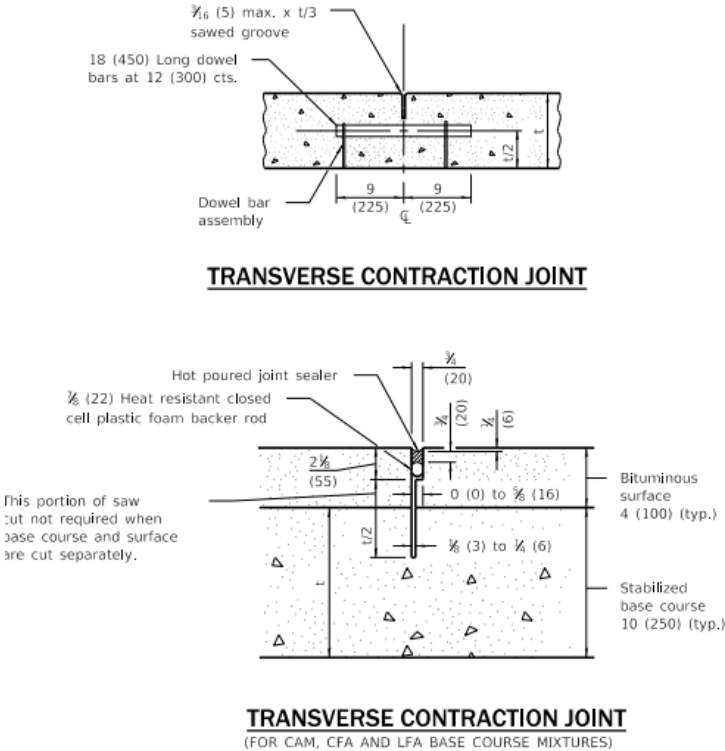
sealing. The Engineer may modify temperature restrictions and protection requirements

**Illinois**

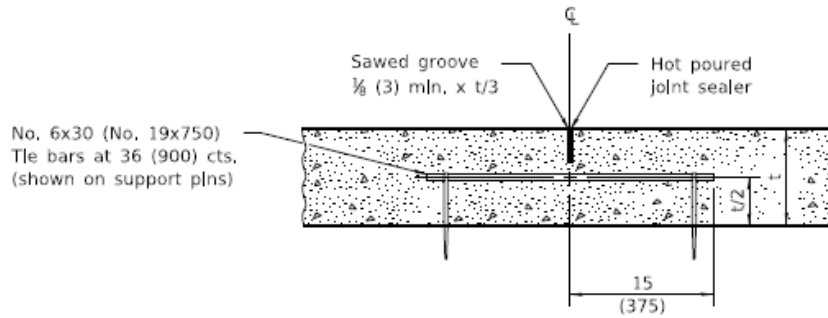
*Joint Design*

Illinois DOT standard transverse contraction joints and longitudinal joints details are depicted in Figure 51 and Figure 52 (Illinois DOT 2021). As stated in Illinois DOT standard, transverse joints are not sealed, because they are typically narrow and because unsealed transverse joints reduce vehicular noise. Longitudinal joints are sealed with hot-poured joint sealant. If concrete pavement is placed on stabilized base course, a hot poured joint sealant is required for transverse contraction joints as shown in Figure 51.

Construction joints will not be required between each day’s work, unless there is a time lapse of seven days or more between the processing of adjacent sections. When construction joints are required, they are formed by cutting back 3 ft. into the completed work to form a vertical face. Otherwise, damage to completed work is to be avoided.



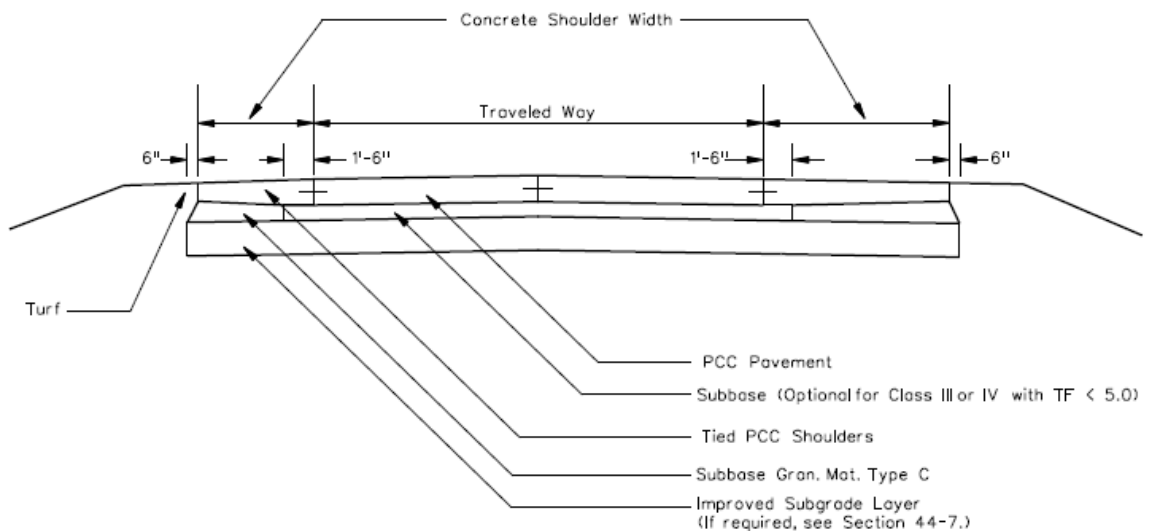
**Figure 51. Transverse contraction joint Illinois DOT standard (Illinois DOT 2021).**



**LONGITUDINAL SAWED JOINT**

**Figure 52. Longitudinal sawed joints Illinois DOT standard (Illinois DOT 2021).**

The maximum transverse joint spacing allowed is 15 ft. Transverse joint spacing depends on the pavement thickness; the maximum transverse joint spacing is 12 ft., if pavement thickness is less than 10 inches, and the maximum transverse joint spacing is 15 ft., if pavement thickness 10 inches or above. It is not recommended to randomize transverse joint spacing unless matching existing joints is required. Illinois DOT specification no longer allows for the use of skewed transverse joints. Dowel bar diameter is 1.5 inches for rigid pavement thickness of 10 inches or above, dowel bar diameter is 1.25 inches for pavement thickness between 8 and 9.99 inches, and dowel bar diameter is 1 inch for pavement thickness of 8 inches or less. Figure 53 shows the typical rigid pavement section.



**Figure 53. Typical rigid pavement design with tied shoulder (Illinois DOT 2021).**

### *Maintenance and Rehabilitation Treatments*

Illinois DOT provides several maintenance and preservation treatment and pavement management guidelines to select proper treatments for concrete pavement distresses. Illinois DOT identified factors that need to be considered to select the most appropriate preservation treatment as follows (Illinois DOT 2021):

- Availability of qualified contractors,
- Availability of quality materials,
- Time (of year) of construction,
- Initial cost,
- Ride quality (i.e., IRI),
- Pavement noise,
- Facility downtime, and
- Surface friction.

Table 14 shows the Illinois DOT treatment selections guidelines for rigid pavements. Pre-treatment activities can be used to eliminate pavement distresses when pavement preservation and rehabilitation treatment are needed. When selecting the final pre-treatment selection, other factors should be considered such as ADT, traffic control operation, constraints, condition of adjacent pavement, and life cycle cost analysis. There are several pre-treatment options that Illinois DOT identified, which may be selected based on the condition of pavement and results of the pavement field investigation. These pre-treatment options are excerpted from Illinois DOT specification (2021):

- Full-depth CRCP patches (Class A): Class A patching consists of removing the failed pavement area and patching it with a full-depth, continuously reinforced PCC patch. This can be applied for CRCP and asphalt overlaid CRCP. The patch dimensions will be a length of 4.50 ft. and a width that includes half the width of the travel lane.
- Full-depth doweled patches (Class B): Class B patching consists of removing the failed pavement area and patching it with a full-depth doweled PCC patch. The minimum patch dimensions will be a length of 6 ft. and a width that includes the full width of the travel lane.

- Full-depth undoweled patches (Class C and Class D): Class C patching consists of removing the distressed pavement area and patching it with an undoweled PCC patch. Class D patching consists of removing the distressed pavement area and replacing it with an asphalt patch. Except in an emergency, Class D patching should not be specified on the Interstate System or on any supplemental freeway constructed to Interstate standards.
- Partial-depth patches: Partial-depth patches are effective at removing distresses that are primarily in the top portion of the pavement (e.g., spalling of joints in a PCC pavement, distresses limited to the asphalt portion of a composite pavement, etc.). This method can be applied for all pavement types. This activity typically uses asphalt patching material, but some applications may warrant using PCC patching material. When patching a bare PCC pavement, the minimum partial-depth patch size will be 2 ft. by 2 ft. at a depth of 2 to 4 inches. If PCC patching material is used, all joints within patches are to be reestablished to prevent random cracking.
- Longitudinal crack repair: Longitudinal crack repair is a cost-effective method of prolonging the service life of a pavement which has distresses along a longitudinal crack while the rest of the pavement is sound. It is important to limit the depth of the milling to just above the depth of the reinforcing steel so as not to damage the steel.

**Table 14. Illinois DOT rigid pavement treatment selection decision matrix (Illinois DOT 2021).**

Pavement Conditions	Distress Levels	Proactive Maintenance Treatments				High Preservation Treatments <sup>1</sup>	
		Crack Sealing	Joint Resealing	Diamond Grinding <sup>2</sup>	Diamond Grooving	LTR <sup>3</sup>	UTBWC
D-cracking	A1, A2	R	N/A	NR	NR	NR	R
	A3	NR	N/A	NR	NR	NR	R
	A4, A5	NR	N/A	NR	NR	NR	NR
Transverse Cracking	B1, B2	R	R	NR	NR	NR	R
	B3	R	R	NR	NR	NR	NR
	B4, B5	NR	NR	NR	NR	NR	NR
Transverse Joint Deterioration	C1, C2	R	R	R	NR	R	R
	C3, C4	NR	NR	NR	NR	NR	NR
Centerline Deterioration	D1	R	R	NR	NR	NR	R
	D2, D3	NR	NR	NR	NR	NR	NR
Longitudinal Cracking	E1, E2	R	R	NR	NR	NR	R
	E3, E4	NR	NR	NR	NR	NR	NR
Edge Punchouts (CRCP)	F1	R	N/A	F	NR	NR	R
	F2, F3	NR	NR	NR	NR	NR	NR
Faulting	≤ 0.15	NR	NR	NR	NR	NR	NR
	> 0.15	NR	NR	R*	NR	R	NR
Corner Breaks (JPCP)	H1	N/A	N/A	N/A	NR	N/A	R
	H2, H3	NR	NR	NR	NR	NR	NR
Map Cracking and Scaling	I1	NR	NR	R	NR	NR	R
	I2	NR	NR	R	NR	NR	R
	I3	NR	NR	R	NR	NR	R
Popouts/High Steel	J1, J2, J3	NR	NR	NR	NR	NR	F**
Permanent Patch Deterioration	K1	R	R	F**	F**	NR	R
	K2, K3, K4	NR	NR	NR	NR	NR	NR
Roughness (High IRI)	IRI > 140 in/mi	NR	NR	R	NR	F*	F
Friction	Poor	NR	NR	R	R	N/A	R
Relative Cost	(\$ to \$\$\$\$)	\$	\$	\$\$	\$\$	\$\$\$	\$\$

R - Recommended treatment. Care must be taken to ensure all critical distress types are addressed by selected treatment.

R\* - Recommended when used in conjunction with LTR.

F - Feasible treatment but depends upon other project constraints including other existing distresses.

F\* - Feasible treatment if poor ride is a result of undoweled joints or faulted transverse (mid-slab) cracking.

F\*\* - Other distress types should dictate choice of treatment.

NR - Treatment is not recommended to correct the specified pavement condition.

N/A - Distress does not impact treatment selection.

1 - Full-Depth and Partial-Depth patching will only be allowed as a mitigating activity. A maximum of 0.50 percent will be allowed.

2 - If intermittent bump grinding, no additional activity necessary. Large areas of > 100 ft in length require diamond grooving.

3 - LTR (Load Transfer Restoration) is normally used in combination with diamond grinding.

### *Subsurface Drainage*

Open graded drainage layer (OGDL) is used to drain water into edge drain system. Stabilized asphalt drainage layer or lean concrete base can be used for concrete pavement. OGDL can be placed as one layer between 3- to 6-inches thick. Winkelman (2004) evaluated several concrete pavement projects built in Illinois with an OGDL. The study found that there was no significant difference between OGDL treated with cement or asphalt, the use of OGDL is more expensive than a standardized base material or lime, the infiltration of fines from the

subgrade and the aggregate separation layer into OGDL led to joint deterioration, pumping, and faulting.

### *Cold Weather Concreting*

The following represents Illinois DOT's specifications for cold weather concreting (Illinois DOT 2004):

Cold weather is defined as whenever the average ambient air temperature during day or night drops below 40 °F. The contractor shall submit a cold weather concreting plan to the Engineer for approval. Minimum requirements:

- The contractor must make the necessary adjustments so that the concrete temperature is maintained from 50 °F to 90 °F for placement. Acceptable methods include heating mixing water and/or heating the aggregate.
- The contractor shall monitor the mix temperature at the plant and prior to placement in the forms. Mix that does not meet the temperature requirement of 50 °F to 90 °F shall be rejected for use on the project.
- Paving or placing concrete on a frozen base, subbase, or subgrade is prohibited. The base, subbase, or subgrade on which the concrete is to be placed shall be thawed and heated to at least 40 °F. The method by which the base subbase or subgrade is to be heated shall be indicated in the contractor's cold weather concreting plan. Insulating blankets or heated enclosures may be required.
- The contractor shall protect the concrete in such a manner as to maintain a concrete temperature of at least 50 °F for 10 days. The method of concrete protection shall be by use of insulating layer or heated enclosure around the concrete.

## **Minnesota**

### *Joint Design*

Minnesota DOT provides guidance to determine joint design and joint sealing requirements for concrete pavements. The standard practice of Minnesota DOT is not to seal any contraction or longitudinal joints on concrete pavement, except for the following (Minnesota DOT 2019):

- All roadways where speed limit is  $\leq 45$  mph, excluding ramps and loops,

- Concrete overlays “whitetoppings” < 6 inches thick,
- Resealing concrete pavement rehabilitation (CPR) projects when roadway speed limits are  $\leq 45$  mph,
- Bridge approach panels,
- Expansion (E) joints.

Standard contraction joints for concrete pavements are typically doweled and the sawcut depth is 1/4 of the slab thickness. The minimum dowel bar size is 1 1/4 inches in diameter by 15 inches long. The sawcut depth of unbonded concrete overlays is 1/3 of slab thickness. The maximum transverse joint spacing is 15 ft. regardless of slab thickness. The rule of thumb of panel joint spacing is equal to 1.5 ft. times the slab thickness in inches.

Table 15 shows joint spacing, dowel bars, and tie bars requirements. Transverse contraction joint designs are presented in Table 16 and Table 17. Minnesota DOT’s specification uses the following joint references (Figure 54):

- C1U: contraction joint unsealed,
- C1U-D: contraction joint unsealed with dowel bars,
- C2H: contraction joint hot pour sealed,
- C2H-D: contraction joint hot pour sealed with dowel bars.

**Table 15. Concrete joint spacing and dowel bars (Minnesota DOT 2019).**

<b>PCC thickness (in.)</b>	<b>Longitudinal joint spacing (ft.)</b>	<b>Transverse joint spacing (ft.)</b>	<b>Dowel bar diameter (in.)</b>	<b>All longitudinal joint (in.)</b>
≥ 10.5	12 – 14	15	1.5*	No. 5 tie bar (36 long)
8-10	12 – 14	15	1.25*	No. 4 tie bar (30 long)
7-7.5	12 – 14	15	1*	No. 4 tie bar (30 long)
6-6.5	6 – 8	6	None	No. 4 tie bar (30 long)

\* Specify a full set of 11 dowels for new/reconstructed PCC pavement and a set of 8 wheelpath dowel for unbonded overlays.

**Table 16. Concrete joint sealing guidelines (Minnesota DOT 2019).**

<b>Type of construction</b>	<b>Speed limit</b>	<b>Base material</b>	<b>Joint reference</b>
All roadways, excluding ramps and loops	≤ 45 mph	All	C2H C2H-D
PCC overlay on existing asphalt < 6” thick	> 45 mph	Existing asphalt	
New construction	> 45 mph	All	C1U C1U-D
Unbonded PCC overlay of existing PCC			
Ramp and loops	All		

**Table 17. Contraction joint reference, detail, and sealant specification (Minnesota DOT 2019).**

<b>Joint reference without dowels</b>	<b>Joint reference with dowels</b>	<b>Joint sealant material and specifications</b>	<b>Joint width</b>
C1U	C1U - D	Unsealed	1/8 in.
C2H	C2H – D	Hot pour – 3725	1/8 in.
C3P	C3P – D	Preformed elastomeric - 3721	3/8 in.



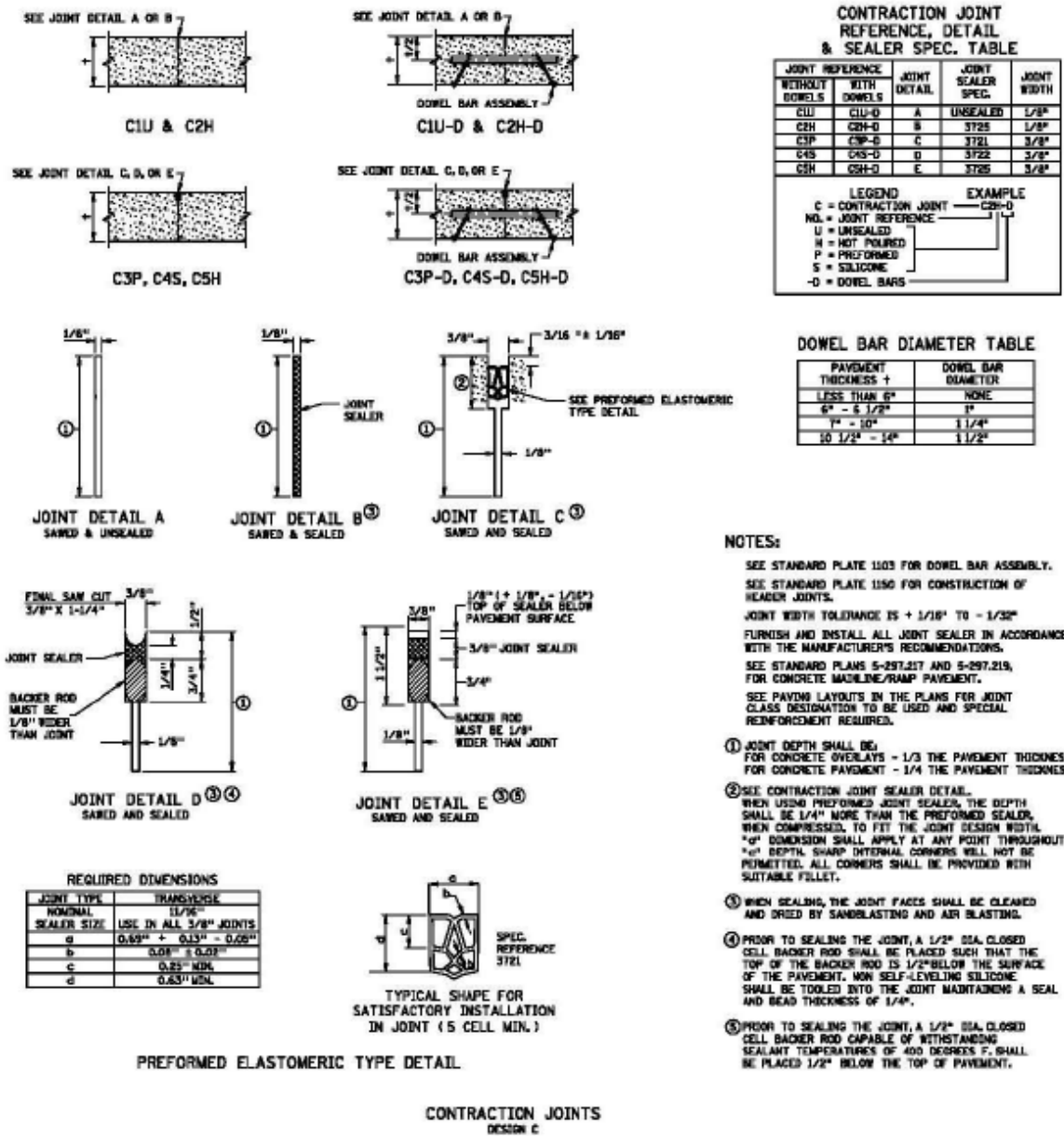


Figure 54. Contraction joints (Minnesota DOT 2019).

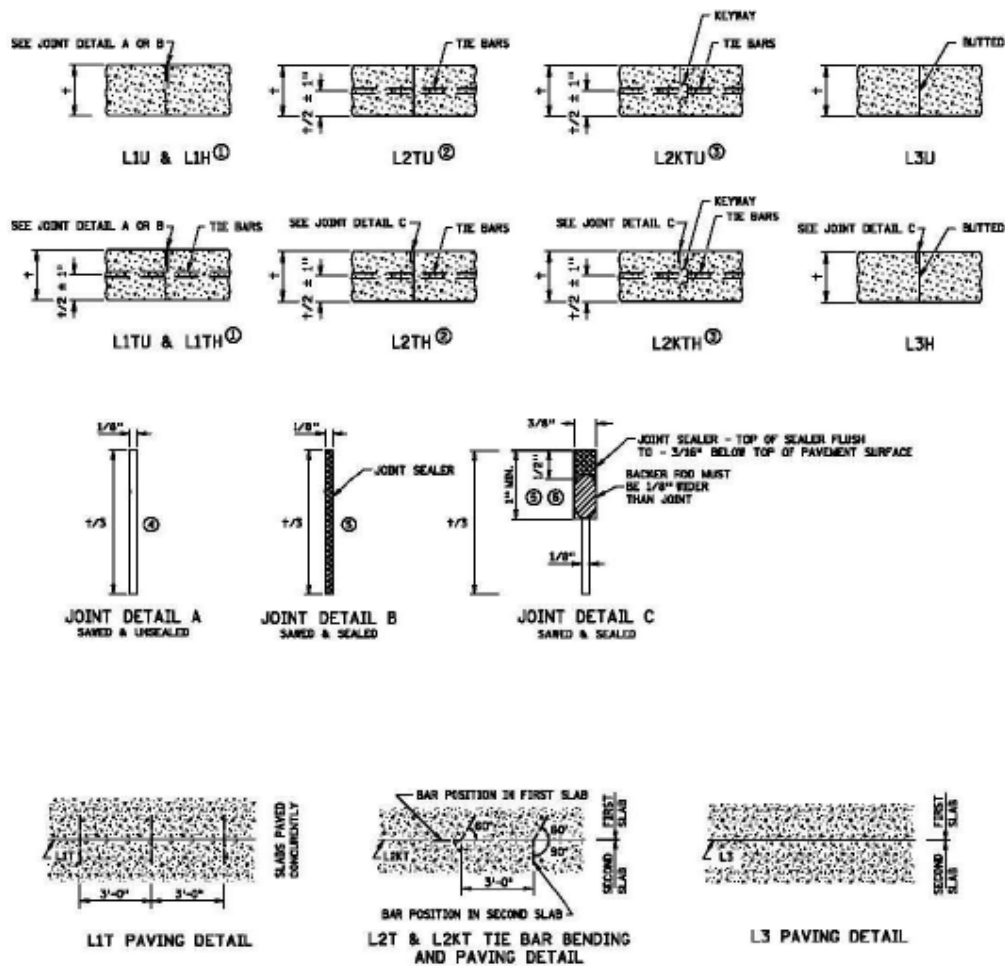
Minnesota DOT’s specification classifies standard longitudinal joints into three types:

- L1T or L1 joint: a sawed joint down the center of a roadway, either tied or untied,
- L3 joint: a construction joint between two concreting operations that are not tied to one another, typically a butt joint,
- L2KT joint: like the L3 joint except the two operations are tied together. The joint of the first pavement should be indented keyway with bending tie steel.

The tie-bars are placed at the mid-depth of the slab. Figure 55 and Table 18 show the joint details and layout of longitudinal joints. Minnesota DOT's specification indicates that expansion joints are rarely used in concrete pavements and if used, it should be constructed as provided in the plans. Expansion joints can be constructed with or without dowel bars. The width of expansion joint is 0.5 in. filled with hot pour sealant. Expansion joints are used at the bridge and its saw-cut width is 4 inches.

**Table 18. Longitudinal joint reference, detail, and sealant specification.**

Joint reference without tie-bars	Joint reference with tie-bars	Joint sealant material and specification	Joint width
L1U	L1TU	Unsealed	1/8 in.
L1H	L1TH	Hot pour – 3725	1/8 in.
	L2TU	Unsealed	
L3U		Unsealed	



**Figure 55. Longitudinal joints (Minnesota DOT 2019).**

### *Maintenance and Rehabilitation Treatments*

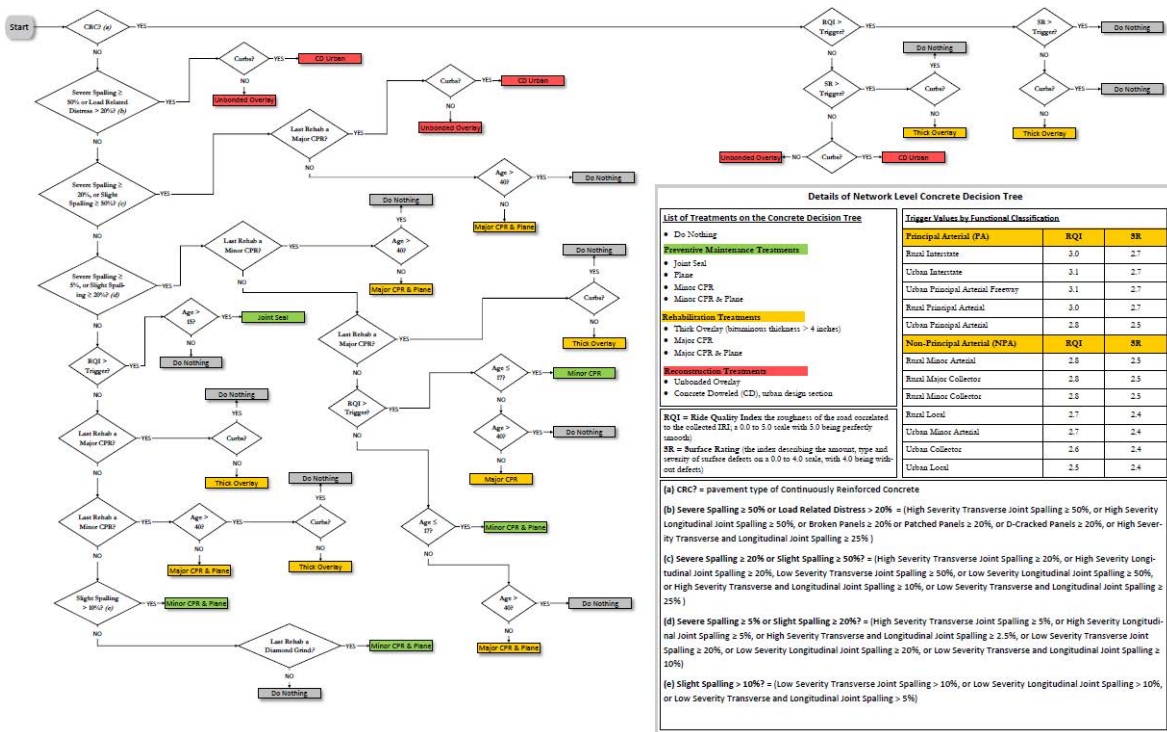
Minnesota DOT developed a decision tree (Figure 56) for concrete pavement treatments (Minnesota DOT 2018). The proper treatment selections in the decision tree depends on the severity levels of distresses and trigger values. Minnesota DOT uses five distresses in the decision tree for selecting the right concrete pavement treatments. These distresses include transverse spall, longitudinal spall, d-cracking, broken panel, patch greater than 5 sq. ft. The severity distresses criteria used in the decision tree are as follows:

- Severe spalling  $\geq$  50 percent or load related distress  $>$  20 percent,
- Severe spalling  $\geq$  20 percent or slight spalling  $\geq$  50 percent,
- Severe spalling  $\geq$  5 percent or slight spalling  $\geq$  20 percent,
- Slight spalling  $>$  10 percent.

Ride quality index (RQI) and surface rating (SR) trigger values for principle arterial and non-principle arterial (Table 19) are used as part of the decision tree to select the right treatments. List of treatment options on the concrete decision tree include do nothing, preventive maintenance treatments, rehabilitation treatments, and reconstruction treatments. Preventive maintenance treatments include joint sealing, diamond grinding, minor concrete pavement rehabilitation (CPR), minor CPR, and diamond grinding. Rehabilitation treatments include thick overlay, major CPR, and major CPR and diamond grinding. Reconstruction treatments include unbonded overlay with concrete dowels. CPR repair types are partial depth patching, full-depth patching, slab replacement, and joint/crack sealing.

**Table 19. Trigger values by functional classification (Minnesota DOT 2018).**

<b>Road functional classification</b>	<b>Ride quality index (RQI)</b>	<b>surface rating (SR)</b>
Rural Interstate	3.0	2.7
Rural Principal Arterial	3.0	2.7
Rural Minor Arterial	2.8	2.5
Rural Major Collector	2.8	2.5
Rural Minor Collector	2.8	2.5
Rural Local	2.7	2.4
Urban Interstate	3.1	2.7
Urban Principal Arterial Freeway	3.1	2.7
Urban Principal Arterial	2.8	2.5
Urban Minor Arterial	2.7	2.4
Urban Collector	2.6	2.4
Urban Local	2.5	2.4



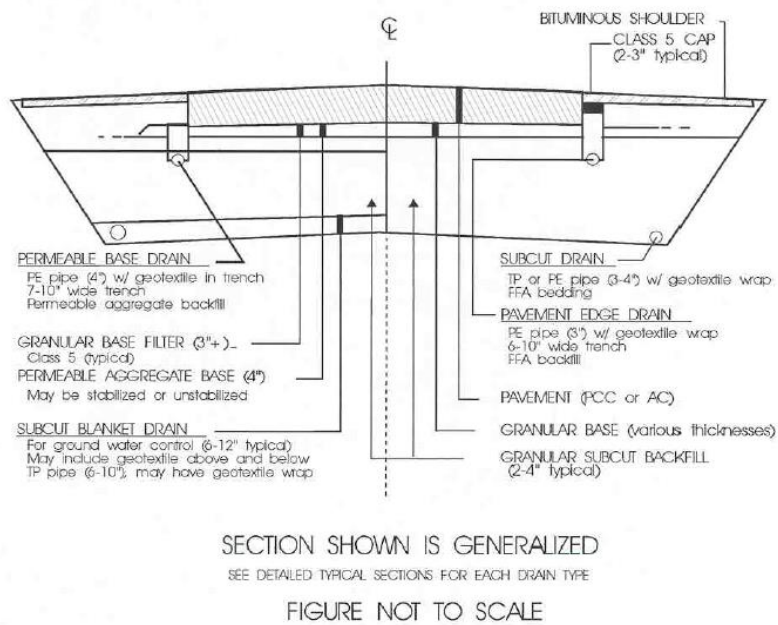
**Figure 56. Network level concrete decision tree (Minnesota DOT 2018).**

### Subsurface Drainage

Minnesota DOT uses either daylighting or subsurface drains to remove excess subsurface water. Subsurface drain layer for new/reconstructed concrete pavements can be an open-graded aggregate base (OGAB) or drainable stabilized base (DSB) with edge drains, a 4 inch thick permeable asphalt stabilized base (PASB) with edge drains, or geo-composite joint drain that drains into either edge drains or a daylighted layer (Minnesota DOT 2019). Figure 57 shows a typical subsurface drainage section. Regular inspection and maintenance are required to sustain an effective drainage system that can remove infiltrated subsurface water.

Canelon and Neiber (2009) examined the effectiveness of different types of pavement subsurface drainage systems to drain excessive subsurface water in Minnesota. Moisture conditions of pavement foundation (e.g., base and subgrade) was measured using an electromagnetic device. Drain outflows were also measured with tipping buckets placed at the outlet points. Statistical analysis results showed that edge drain effectively drained excess subsurface water compared to centerline drains. Moisture measurements indicated that edge drains showed less moisture content in pavement structures in comparison to centerline drains.

The study concluded that edge drains effectively drains trapped water underneath the pavement and centerline drains could help if the source of water is an artesian groundwater.



**Figure 57. Typical subsurface drainage section (Minnesota DOT 2007).**

### *Cold Weather Concreting*

The following represents Minnesota DOT’s specifications for cold weather concreting (Minnesota DOT 2018):

If the national weather service forecast for the construction area predicts air temperatures of 36 °F or less within the next 24 h and the Contractor wishes to place concrete, submit a cold weather protection plan. Maintain concrete temperature from 50 °F to 90 °F until placement. Contractor must use proper judgement in assuring that the concrete pavement does not freeze.

All of the materials listed below should be used in conjunction with regular membrane curing compound or extreme service membrane curing compound, depending on the date and location of the project. These guidelines are considered to be the minimum protection against frost, use of these guidelines does not guarantee concrete won't freeze or sustain other cold weather damage.

- One sheet of plastic: If overnight low temperature is expected to be from approximately 3 to 6 degrees Fahrenheit below freezing.
- Two sheets of plastic: If overnight low temperature is expected to be from approximately 7 to 10 degrees Fahrenheit below freezing.

- Straw or similar insulating material: If overnight low temperature is expected to be approximately 10 degrees or more below freezing.

## **Michigan**

### *Joint Design*

Michigan DOT's specification classifies longitudinal joints into two main types. Longitudinal lane tie joints with straight tie bars (symbol D and symbol S) and longitudinal bulkhead joints (symbol B) (Figure 58) (Michigan DOT 2020a, Michigan DOT 2020b). The minimum sawcut width is  $\frac{1}{4}$  inch and depth is  $\frac{1}{3}$  of pavement thickness ( $T/3$ ). Joints are sealed with hot poured rubber asphalt. Tie spacing depends on the total distance of tied joint from nearest free edge.

Transverse contraction joints are sealed with low modulus hot-poured rubber asphalt type joint sealing compound (Figure 59). Backer rod is used. The groove depth is 1.375 to 1.5 inch. The sawcut width of transverse joint is  $\frac{1}{4}$  inch and depth is  $\frac{1}{4}$  of PCC thickness less than or equal to 7 inches ( $T/4$ ). The depth of sawcut is  $\frac{1}{3}$  of PCC thickness for greater than 7 inches ( $T/3$ ). Transverse construction or end of pour joint can be constructed using plastic tube method, split header method, or drilled in method. Hot pour rubber-asphalt sealant of  $\frac{1}{2}$  inch by  $\frac{1}{2}$  inch with bond breaker tape placed below sealant is used for plastic type method.

Sawed expansion joints are sealed with low modulus hot-poured rubber asphalt type joint sealing compound. Dowel bars are used in expansion joints. The final groove width is 1 inch plus any increase or minus any decrease in the width of the relief cut. The final sawcut is specified to be to the top of the fiber filler (Figure 60).

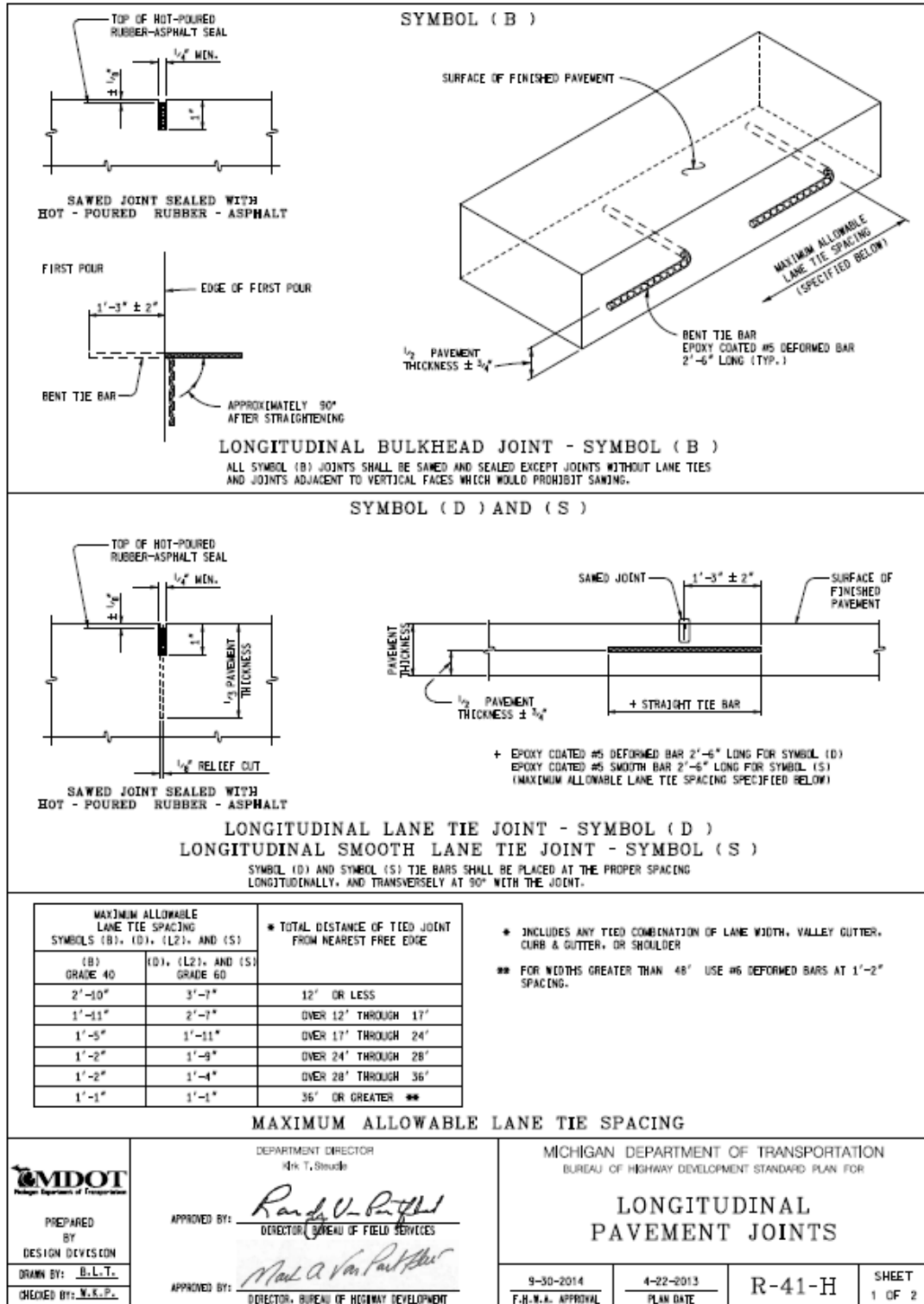
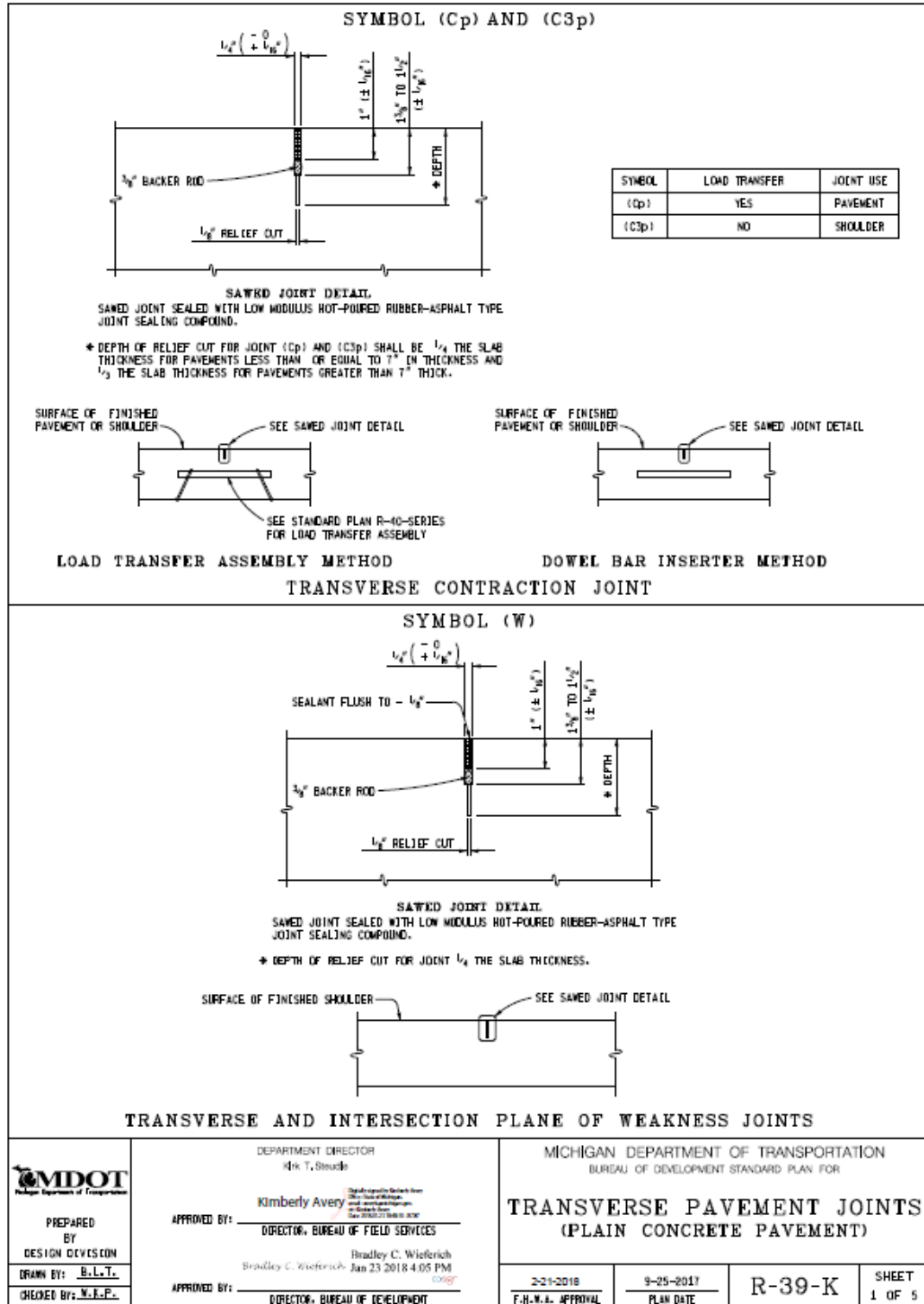


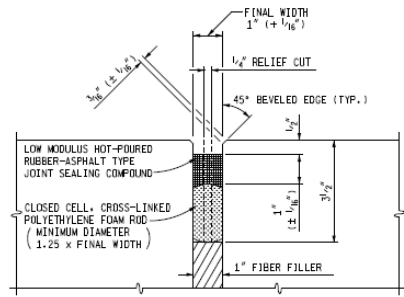
Figure 58. Longitudinal pavement joints (Michigan DOT 2020a).



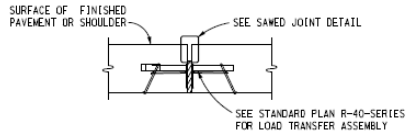
**Figure 59. Transverse construction joints (Michigan DOT 2020a).**



SYMBOL (E2) AND (E4)



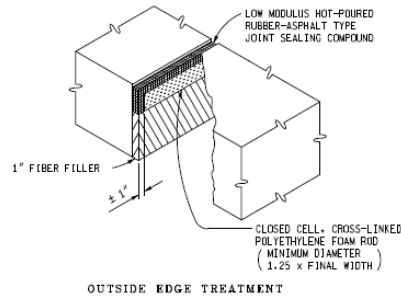
**SAWED JOINT DETAIL**  
SAWED JOINT SEALED WITH LOW MODULUS HOT-POURED RUBBER-ASPHALT TYPE JOINT SEALING COMPOUND.



NOTE:

THE FINAL WIDTH OF THE GROOVE SHALL BE  $1" + \frac{1}{16}"$  PLUS ANY INCREASE OR MINUS ANY DECREASE IN THE WIDTH OF THE RELIEF CUT. THE FINAL SAW CUT SHALL BE TO THE TOP OF THE FIBER FILLER WITH A MINIMUM DEPTH AS SHOWN AND SHALL BE CENTERED OVER THE FIBER FILLER WITH A HORIZONTAL TOLERANCE OF  $\frac{1}{2}"$ . FIBER FILLER FOR EXPANSION JOINTS IN CONCRETE SHOULDERS SHALL BE FREE OF HOLES OR OTHER DEFECTS AND TRIMMED TO FIT SHOULDER CONFIGURATIONS.

SYMBOL	LOAD TRANSFER ASSEMBLY	JOINT USE
(E2)	YES	PAVEMENT
(E4)	NO	SHOULDER



**OUTSIDE EDGE TREATMENT**

TRANSVERSE EXPANSION JOINT

**Figure 60. Transverse expansion joints (Michigan DOT 2020a).**

*Maintenance and Rehabilitation Treatments*

Table 20 summarize Michigan DOT’s concrete pavement treatments and threshold pavement condition values (Michigan DOT 2020c). Three key factors are considered for selecting the proper treatment options for concrete pavements. These factors are remaining service life (RSL), distress index (DI), and international roughness index (IRI). Michigan DOT recommended threshold values of pavement condition levels to assist engineers in identifying the proper treatments for existing concrete pavements. The preventive maintenance treatments should be applied for concrete pavements with a remaining service life of greater than two years.

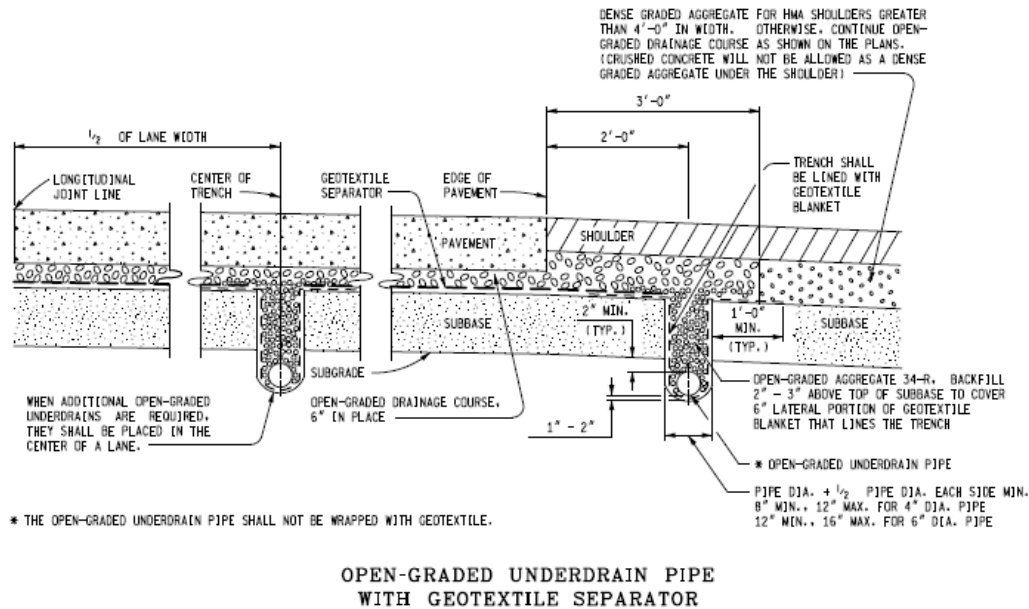
Michigan DOT’s Capital Preventive Maintenance manual guidelines provides description, purpose, existing pavement condition and pavement surface preparation, performance, and performance limitation of each treatment types as listed in Table 20. Pavement with high severely distressed or distorted structures or cross sections are typically not candidate projects for the Capital Preventive Maintenance Program. Users of this manual guidelines need to utilize both visual inspection and data from pavement management system (PMS) before identifying the proper treatments.

**Table 20. Concrete pavement treatments and trigger vales (Michigan DOT 2020c).**

Treatment types	Pavement condition levels			Life extension (yrs.)
	Minimum RSL (yrs.)	Distress index (DI)	IRI	
Joint Resealing with Minor Spall Repair	10	<15	<107	3 to 5
Concrete Crack Sealing	10	<15	<107	Up to 3
Diamond Grinding and Grooving	12	<10	90-125	3 to 5
Full Depth Concrete Pavement Repairs	7	<20	<107 <sup>a</sup>	3 to 10
Partial Depth Concrete Pavement Repairs	7	<20	<107	3 to 10 <sup>b</sup>
Dowel Bar Retrofit	10	<15	<107	2 to 3
Concrete Pavement Restoration	3	<40	<212	5 to 10
Note: the full depth concrete pavement is limited to 30 patches per lane mile <sup>a</sup> Higher IRI numbers should be consider concrete pavement rehabilitation <sup>b</sup> Michigan DOT acknowledge that partial depth concrete repair will provide a life extension to a pavement, however, data are not available to quantify the life extension				

*Subsurface Drainage*

One of current methods of subsurface drain system in Michigan is shown in Figure 61 (Michigan DOT 2019). The maximum thickness of open graded drainage course (OGDC) must not exceed 10 inches and typically 6-inch thick OGDC is used for subsurface drainage. OGDC is placed below the pavement surface. Geotextile or dense-graded aggregate separator layer can be used between the OGDC and subbase or subgrade. Subgrade and subbase underdrains were also described in DOT’s road design manual. The application of subgrade drain is to drain subgrade and subbase while subbase underdrain is to only drain the subbase. Subbase underdrain is placed below the dense-graded aggregate base. Subbase underdrain pipe should be warped with geotextile.



**Figure 61. Typical subsurface drain system (Michigan DOT 2019).**

### *Cold Weather Concreting*

The following represents Michigan DOT's specifications for cold weather concreting (Michigan DOT 2020):

Cold weather is determined to occur when the air temperature has fallen to, or is expected to fall below 40 °F. Do not place concrete if the air temperature is below 40 °F, unless form interiors, metal surfaces, and the adjacent concrete surfaces are preheated to at least 40 °F. Do not begin placing concrete if the air temperature is below 35 °F unless a specific cold weather quality control plan has been approved by the Engineer.

During cold weather, use measures to protect the concrete following placement and continuing until the concrete has reached its open to traffic strength.

- Provide concrete that has a minimum temperature of 55 °F at time of placement.
- If the National Weather Service forecasts air temperatures below 20 °F during the curing period, provide material and heating equipment on the project to protect forms and concrete.
- Cold weather protection shall consist of a method or combination of methods that ensure the concrete temperature will be maintained above 50 °F from the time that it is placed until the concrete attains opening to traffic strength.

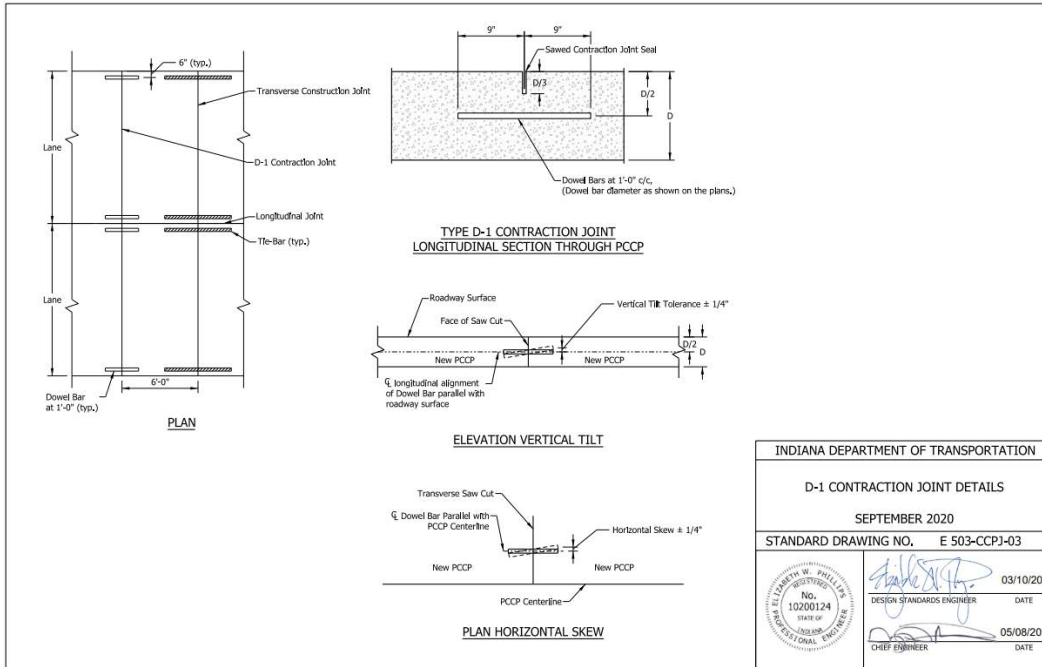
- Methods may consist of heating concrete ingredients, adding chemical accelerators, or physically covering the concrete with a protective barrier such as plastic sheeting, frost paper, insulating blankets, straw over plastic, or other methods approved by the Engineer.
- Continue to provide an ASR-resistant mix when paving during cold weather conditions.

## **Indiana**

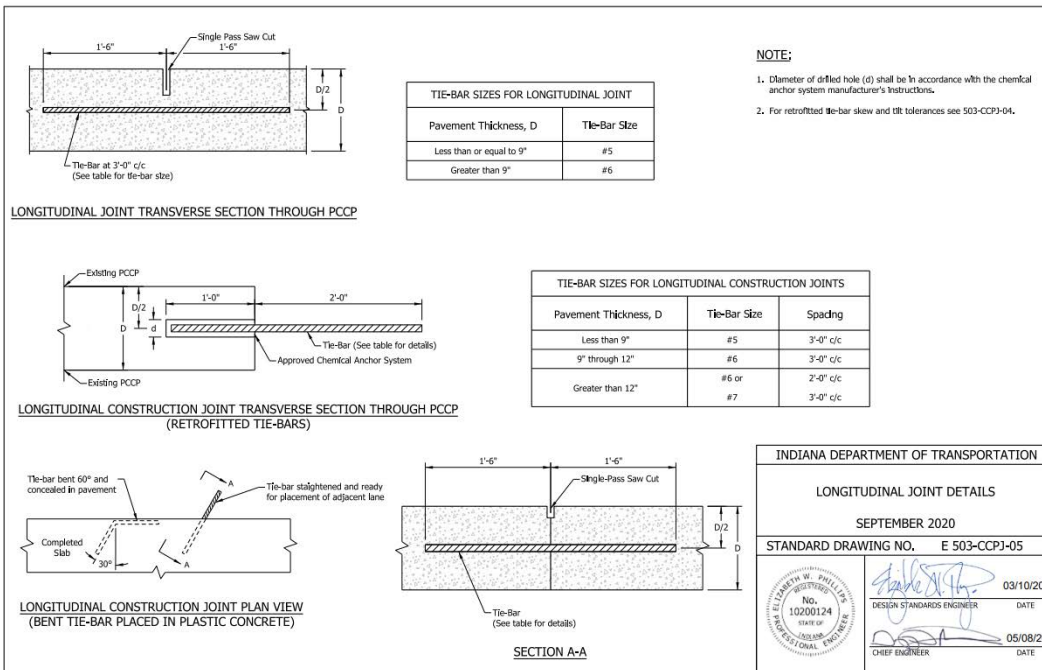
### *Joint Design*

Indiana DOT's specification categorize joint types (Indiana DOT 2021) as follow:

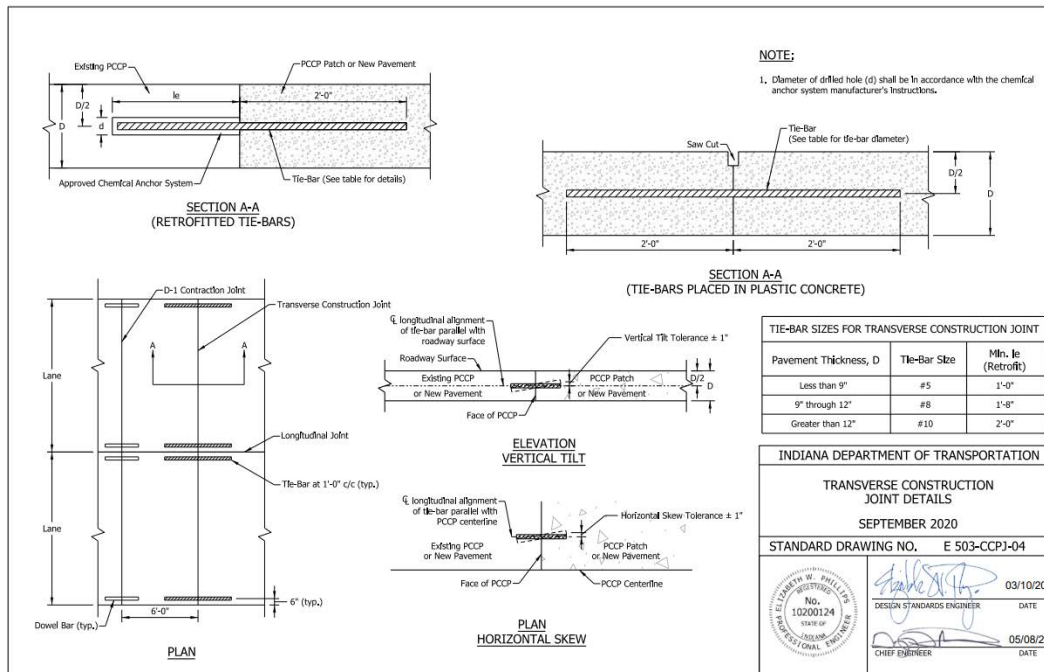
- Type D-1 contraction joint: the maximum transverse contraction joint spacing shall not exceed 18 ft. The sawcut width is ¼ inch and depth is 1/3 of pavement thickness (T/3). Joints are sealed with hot poured joint sealant in accordance with sealant manufacturer's recommendations. Joint should be cleaned before sealing and water blasting shall not be applied under pressure to avoid damage the concrete (Figure 62).
- Longitudinal joint: the maximum longitudinal contraction joint spacing shall not exceed 14 ft. The sawcut width is ¼ inch and depth is 1/3 of pavement thickness (T/3). Joints are sealed with hot poured joint sealant in accordance with sealant manufacturer's recommendations (Figure 63).
- Transverse construction joints: Joint should be placed if the construction is interfered more than 30 minutes in concrete paving operation (Figure 64). Tie bars may be placed in either plastic or hardened concrete.
- Longitudinal construction joint: the sawcut depth of joint is 1 inch (Figure 63). Joints are sealed with hot poured joint sealant in accordance with sealant manufacturer's recommendations.
- Expansion joints: if doweled bars are used, the joint shall be constructed with expansion caps and joint filler components. Joints should be sealed with hot poured joint sealant in accordance with sealant manufacturer's recommendations.



**Figure 62. Type D-1 contraction joint (Indiana DOT 2021).**



**Figure 63. Longitudinal contraction and construction joint (Indiana DOT 2021).**



**Figure 64. Transverse construction joint (Indiana DOT 2021).**

*Maintenance and Rehabilitation Treatments*

Table 21 summarize Indiana DOT’s concrete pavement preventive maintenance treatments (Indiana DOT 2018). The proper treatments selection for concrete pavement depend on a combination of pavement distresses criteria. Partial-depth patching is used to remove the one third of the upper concrete pavement joint to improve ride quality. Full-depth patching is used to replace deteriorated joints. Patching a spalled transverse joint is a temporary solution for short-term, however, full-depth repair should be considered. Indiana DOT recommends inspecting joint condition of concrete pavement at 8 to 10 years old to clean and reseal damaged joint as needed. If 10 percent of the joints have loose, or missing sealant, sawing and sealing of the joint should be considered.

**Table 21. Concrete preventive maintenance treatments (Indiana DOT 2020).**

Treatments types	Pavement distresses	Friction treatment
Crack seal	Mid-panel cracks with aggregate interlock	No
Saw and seal joints	> 10 percent of joints with missing sealant, otherwise joints in good condition	No

<b>Treatments types</b>	<b>Pavement distresses</b>	<b>Friction treatment</b>
Retrofit load transfer	Low to medium severity mid-panel cracks; pumping or faulting at joints <0.25 inch	No
Surface profiling	Faulting<0.25 inch; poor ride; friction problems	Yes
Partial-depth patch	Localized surface deterioration	
Full-depth patch	Deteriorated joints; faulting>0.25 in.; cracks	No
Underseal	Pumping; void under pavement	No
Slab jacking	Settled slabs	No

### *Subsurface Drainage*

Indiana DOT (Indiana DOT 2020) standard specifies that subbase layer for concrete pavement should consist of 3 inches of aggregate No. 8 as the aggregate drainage layer placed over a #53 6-inch coarse aggregate as the separation layer. The moisture content of aggregate is specified to be between 4 percent of the optimum moisture content before placement. Drainage layers for concrete pavement are aggregate drainage layer or open graded asphalt layer (asphalt treated permeable base). Open graded asphalt layer is typically placed at 250 lb/yd<sup>2</sup> to 300 lb/yd<sup>2</sup>. Geotextile or aggregate can be used as a separator layer to prevent pumping of erodible subgrade materials. Ceylan et al. (2013) highlights the changes in Indiana DOT subsurface drainage policy; (1) inspection of all edge drains and repair of deficiencies of all construction projects will be the contractor's responsibility, the use of large cast, or in-place concrete outlet protectors instead of pre-cast concrete, and a routine inspection and maintenance program was implemented.

### *Cold Weather Concreting*

The following represents Indiana DOT's specifications for cold weather concreting (Indiana DOT 2020):

When it is necessary to place concrete at or below an atmospheric temperature of 35 °F, or whenever it is determined that the temperature may fall below 35 °F within the curing period, the water, aggregates, or both shall be heated and suitable enclosures and heating devices provided. Cold weather concrete shall be placed at the risk of the Contractor and shall be removed and replaced with no additional payment if it becomes frozen or otherwise damaged.

When aggregates or water are heated, the resulting concrete shall have a temperature of at least 50 °F and not more than 80 °F at the time of placing. The maximum temperature of concrete produced with heated aggregates shall be 90 °F. Neither aggregates nor water used for mixing shall be heated to a temperature exceeding 150 °F. When aggregates or water are heated to 100 °F or above, they shall be combined first in the mixer before the cement is added.

Immediately after a pour is completed, the freshly poured concrete and forms shall be covered so as to form a complete protective enclosure around the element being poured. The air within the entire enclosure shall be maintained at a temperature above 50 °F for a minimum of 144 h for bridge decks, the top surface of reinforced concrete slab bridges, and for a minimum of 72 h for all other concrete. If for any reason this minimum temperature is not maintained, the heating period shall be extended. All necessary measures shall be taken during protective heating to keep the heating equipment in continuous operation and to ensure maintenance of the proper temperature around all sides, top and bottom of the concrete. The curing compound may be warmed in a water bath during cold weather at a temperature not exceeding 100 °F.

## **Ontario**

### *Joint Design*

The Ministry of Transportation Ontario (MTO) conducted comprehensive study to evaluate premature joint deteriorations of concrete pavement that were observed eight years after construction (Chan et al. 2020). Field investigations and laboratory testing were conducted on about 7.5 miles long section of the westbound lanes (WBL) of Highway 417, between Ottawa and Montreal. Researchers observed in one section of highway that deterioration of joints appeared on the surface after eight years of concrete placement. The section was then reconstructed because it experienced high severity of longitudinal and transverse spalling after 14 years of placement. Figure 65 shows an example of transverse and longitudinal joint spalling and deterioration on Highway 417 section. Some joints in the same sections appears in good condition with no visible damage. Cores were taken from joints that appeared in good conditions and researchers found that joints were spalled/deteriorated beneath the joint sealant as shown in Figure 66. Cores were also taken from middle of slab to evaluate materials properties (e.g., strength, quality of air system) in laboratory. The study concluded that the initial deterioration started at the lower reservoir sawcut area; below the joint sealant/backer rod due to the inflation of fluid and subsequent freeze-thaw cycles. Over time, the deterioration of joint manifest itself in



form of severe spalling. The key factors that caused joint spalling were freeze-thaw damage of saturated joints along with the impact of deicing chemicals.



**Figure 65. Deteriorated Joints on Highway 417 (Chan et al. 2020).**

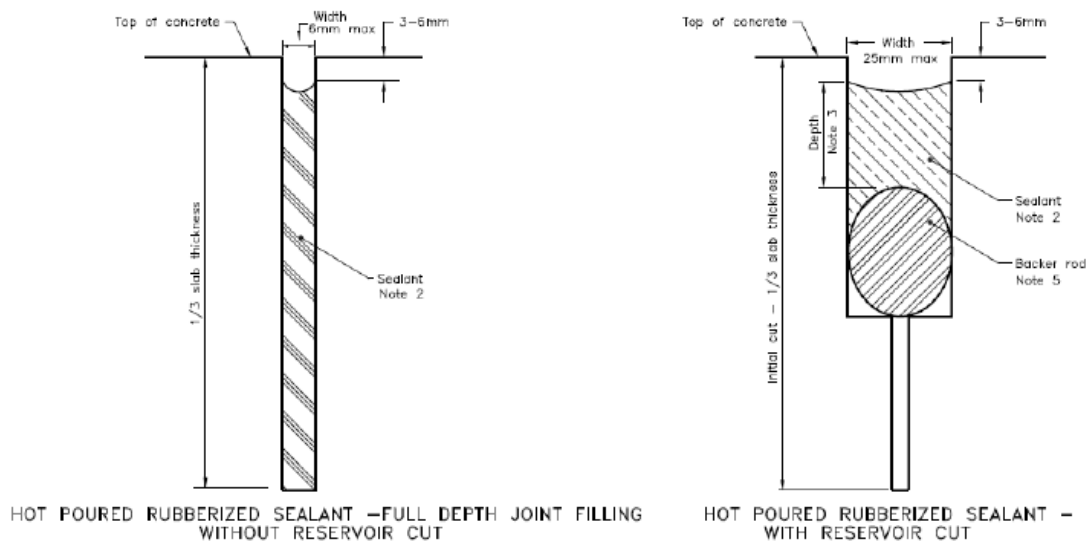


**Figure 66. Deterioration below the surface of a visibly intact joint on Hwy 417 (Chan et al. 2020).**

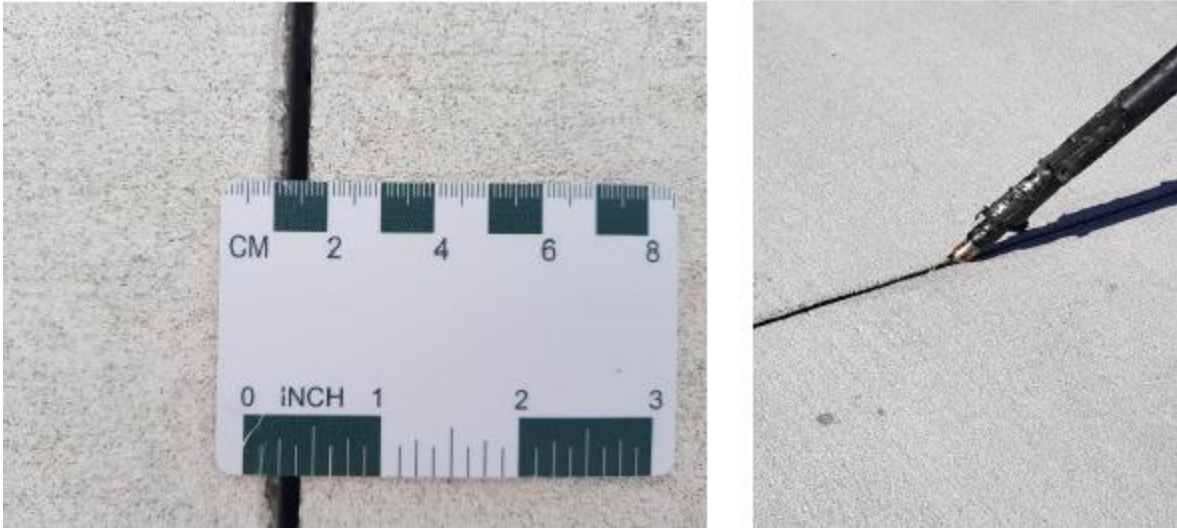
In 2018, concrete pavement specification was altered to minimize/prevent the risk of joint deterioration/spalling based on the findings from this study. The main specification changes to address this issue was to modify the existing joint design and improve concrete properties.

Several other changes in the specification include improved friction, change in QC/QA with regards to smoothness and dowel elements as summarized below:

- One of the key changes in MTO specifications was to alter a 1 inch (25 mm) wide reservoir sawcut with of backer rod to a maximum of ¼ inch (6 mm) wide joint filled with a low-modulus joint sealant (Figure 67 to Figure 69).
- Chan et al. state that the new joint design has been implemented by several agencies including New York Department of Transportation and was recommended by experts.
- To prevent locked-up joints from dowel bars, MTO specifications provides an incentive for dowel alignment. Pulse induction measurements for dowel alignment must be conducted as part of agency acceptance instead of contractor QC testing.
- Compressive strength, permeability, air void system, and the maximum allowable slag content have been changed to the following requirements:
  - 28-day compressive strength from 4,350 psi (30 Mpa) to 5,070 psi (35 Mpa),
  - maximum permeability of 2,500 coulombs using the rapid chloride permeability (RCP) test, and
  - minimum hardened air system (AVS) of 3 percent air content and a maximum spacing factor of 0.230 mm.
- MTO specifications changed transverse tining to longitudinal grooving to reduce noise.



**Figure 67. New (left) and old (right) joint design schematics (MTO 2018).**



**Figure 68. New joint design filled with a low-modulus joint sealant (MTO 2018).**



**Figure 69. Core at the joint filled with sealant (MTO 2018).**

### Maintenance and Rehabilitation Treatments

The decision matrix strategies for concrete pavement maintenance, preservation and rehabilitation treatments types are illustrated in Table 22 (MTO 2013). MTO uses riding comfort index (RCI), distress manifestation index (DMI), and pavement condition index (PCI) trigger level for each road classification to assist in making decisions to find optimum strategies to provide, evaluate, and maintain the pavement network in an acceptable condition. Routine maintenance includes treatments such as spall repair, blow-up, and distortion repairs. Cold mix can be used for temporary spall repair and for long-term spall repair, concrete is used to patch the spall. Hot-mix asphalt can be used temporarily to repair blow-up and cast-in-place concrete can be used to replace the HMA patching. Major rehabilitation that are used by MTO for concrete pavements include concrete overlays, crack and sealing with resurfacing, rubblizing and resurfacing, full-depth slab repair, and precast concrete slab repair.

**Table 22. Decision matrix for rigid pavement (MTO 2013).**

Treatment Activity		Restoring or Improving Pavement Surface in Terms of:					Expected Service Life (years)	
		Preventing Water Infiltration/ Incompressibles	Localized Severe Distress	Faulting, Spalling, or Poor Skid Resistance	Ride Quality	Environmental Deterioration		Structural Capacity & Traffic
Routine Maintenance	Pothole Repair	●	◆		●		< 1	
	Spall Repairs	○	●	◆	●		3-5	
	Blow ups		◆		●		1-5	
	Localized distortion repair		◆			○	2-5	
	Resealing and sealing of joints and cracks*	◆					7-10	
Minor Rehabilitation / Preservation*	Load transfer retrofit*			◆	●		○	10-15
	Full depth joint repair*	○		◆	●		○	10-15
	Full depth stress relief joints*			◆		●		5-10
	Milling of stepped joints and distortion*			●	◆	○		8-10
	Subsealing & joint stabilization	●	○	●				5-10
	Surface texturization / diamond grinding*			◆	●			8-12
	HMA resurfacing*	●		○	●	○	○	5-10

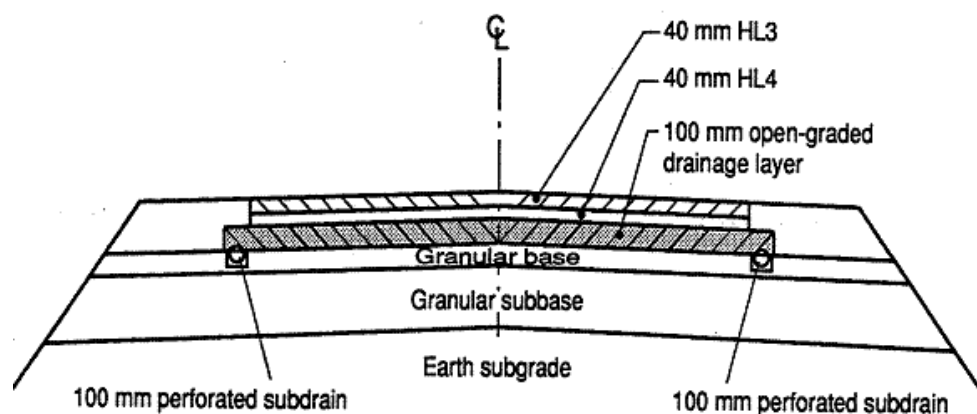
**Legend:**

- \* Pavement Preservation Treatments
- ◆ Primary Application
- Commonly Used
- May be considered

### Subsurface Drainage

MTO drainage system include subdrains, granular sheeting or open-graded drainage layers (OGDL). Figure 70 shows a typical cross-section of OGDL with subdrain. The thickness

of the OGDL is specified to be 4 inches (100 mm) and the unit weight is specified to be 1.3 t/yd<sup>3</sup> (1.7 t/m<sup>3</sup>). The OGDL is placed below concrete pavement and above a granular base course. MTO specification provides the gradation requirements for base, subbase, and OGDL materials along with their permeability values. The OGDL permeability values range from 4 to 0.04 in/sec (10 to 10<sup>-1</sup> cm/sec). The MTO standards include stabilized OGDL treated with either 1.5 to 2.0 percent asphalt cement or 265 to 397 lb./ton of hydraulic cement. Conventional paving machine is utilized to place a 4-inch lift of OGDL on a minimum 6- to 12-inch granular base thickness. The OGDL can be used for all type of pavements.



**Figure 70. Typical cross-section of subsurface drainage system (MTO 2013).**

### *Cold Weather Concreting*

The following represents Ontario Ministry of Transportation's specifications for cold weather concreting (MTO 2021):

Concrete shall not be placed when the ambient air temperature is below 0 °C (32 °F) and shall not be placed against any material whose temperature is below 5 °C (41 °F).

The Contractor shall provide protection to ensure the minimum in-place temperature of the concrete pavement or concrete base is 15 °C (59 °F) for the first three days of curing, and at 10 °C (50 °F) for the subsequent 4 days.

Concrete shall not be placed by slip-forming when the air temperature is below 0 °C (32 °F). Placing concrete by slip-forming shall not be carried out when the air temperature is below 5 °C (41 °F) unless the concrete at the time of placing is between 15 °C (59 °F) and 30 °C (86 °F).

Concrete placed by slip-forming when the air temperature is below 5 °C (41 °F) or concrete subject to temperatures below 5 °C (41 °F) during the first 7 days.

When the concrete pavement or concrete base requires protection by insulation, no more than 25 linear metres (82 linear feet) of concrete pavement or concrete base shall be exposed for sawcutting operations at any one time. In no case shall any concrete pavement or concrete base be exposed for more than one hour during sawcutting.



## References

Burke Jr., M. P., "Bridge Approach Pavements, Integral Bridges, and Cycle-Control Joints," *Transportation Research Record*, No. 1113, pp. 54-65, 1987, Transportation Research Board.

Burke Jr., M. P., "Pavement Pressure Generation Neglected Aspect of Jointed Pavement Behavior," *Transportation Research Record*, No. 1627, 1998, Transportation Research Board.

Darter, M. I., *Report on the 1992 U.S. Tour of European concrete Highways*, Publication No. FHWA-SA-93-012, 1993, Federal Highway Administration, Washington, D.C., 20590.

Darter, M. I., Barenberg, E. J., and Yrjanson, W. A., *Joint Repair Methods for Portland Cement Concrete Pavements*, National Cooperative Highway Research Program Report No. 281, 1985, Transportation Research Board.

Darter, M. I., Barnett, T. L. and Morrill, D. J., *Repair and Preventive Maintenance Procedures for Continuously Reinforced Concrete Pavement*, Report No. FHWA/IL/UI-191, 1981, Cooperative Research Program between University of Illinois, Illinois Department of Transportation and Federal Highway Administration.

Darter, M. I. and Peterson, D.E., *Thermal Expansion and Contraction of Concrete Pavement in Utah*, Research Report No. 915, 1970, HPR Cooperative Program, Utah Highway Department/U.S. Department of Transportation, Federal Highway Administration.

Canelon, D. J. and Nieber, J. L. 2009. Evaluating Roadway Subsurface Drainage Practices. MN/RC 2009-08. Minnesota: Minnesota Department of Transportation Research Services Section.

Chan, S., Titherington, M., and Lee, S., 2020. Specification Improvement to Deliver Safe and Durable Concrete Pavement in Ontario. In Transportation Association of Canada 2020 Conference and Exhibition-The Journey to Safer Roads.

Ceylan, H., Gopalakrishnan, K., Kim, S. and Steffes, R. F. 2013. Evaluating Roadway Subsurface Drainage Practices. Iowa Highway Research Board Project TR-643, Iowa Department of Transportation.

Crovetti, J. A., and Kevern, J. T. Joint Sawing Practices and Effects on Durability. Wisconsin Department of Transportation, Report No. WHRP 0092-16-01, 2018.

Foxworthy, P. T. Statewide Survey of Blowups in Resurfaced Concrete Pavements. Indiana State Highway Commission State Office of Building, Project No. C-36-460, 1973.

Gress, D. L. Blow-ups on Resurfaced Concrete Pavements. Indiana State Highway Commission State Office of Building, Report No. No. JHRP-76-25, Indianapolis, Indiana, 1976.

Hall, K., and Tayabji, S. Coefficient of Thermal Expansion in Concrete Pavement Design. No. FHWA-HIF-09-015, ACPT Tech-Brief, 2011.

Harrington, D., Ayers, M., Cackler, T., Fick, G., Schwartz, D., Smith, K., Snyder, M. B., and Van Dam, T. Guide for Concrete Pavement Distress Assessments and Solutions: Identification, Causes, Prevention, and Repair. Federal Highway Administration. 2018.

Hoerner, T. E., Darter, M. I., Khazanovich, L., Titus-Glover, L. Improved Prediction Models for PCC Pavement Performance-Related Specifications. Volume I: Final Report, Federal Highway Administration, 2000. McBride, J. C., and Decker, M. S. Performance Evaluation of Utah's Concrete Pavement Joint Seals. Transportation Research Record 535, Transportation Research Board, Washington, D.C., Number (535), pp. 35-50, 1995.

Illinois Division of Highways. A Study of Blowups in Rigid Pavements in Illinois. Research and Development Report 18, 1957.

Illinois Department of Transportation (Illinois DOT). 2021. Illinois Construction Manual. Illinois Department of Transportation. Springfield, IL.

Illinois Department of Transportation (Illinois DOT). 2021. Pavement Preservation Chapter 53. Illinois Department of Transportation: Bureau of Design & Environment Manual, Springfield, IL.

Illinois Department of Transportation (Illinois DOT). 2004.  
<https://idot.illinois.gov/Assets/uploads/files/Doing-Business/Manuals-Guides-&-Handbooks/Aero/Pol%202001-1%20Cold%20Weather%20Concrete.pdf>

Indiana Department of Transportation (Indiana DOT) .2018. Design Manual, Chapter 304: Comprehensive Pavement Analysis. Frankfort, IN.

Indiana Department of Transportation (Indiana DOT). 2020. Standard Specifications. Indiana Department of Transportation, Frankfort, IN.

Indiana Department of Transportation (Indiana DOT). 2021. Standard Drawing. Michigan Department of Transportation, Frankfort, IN.



Indiana Department of Transportation (Indiana DOT). 2021. Standard Specification for Construction. Michigan Department of Transportation, Frankfort, IN.

Iowa Department of Transportation (Iowa DOT). 2015. Standard Specification for Highway and Bridge Construction. Iowa Department of Transportation. Ames, IA.

Iowa Statewide Urban Design and Specifications (SUDAS). 2021. Iowa Department of Transportation. Ames, IA.

Kerr, A. D. and Dallis, A. Blowup of Concrete Pavements. Journal of Transportation Engineering, Vol. 111, No. 1, pp. 33-53, 1985.

Kerr, A. D. and Shade, P. J. Analysis of Concrete Pavement Blowups, *Acts Mechanical* 52, 201--224 (1984).

Khazanovich, L., Hoegh, K., and Snyder, M. B. Guidelines for Dowel Alignment in Concrete Pavements. Transportation Research Board, NCHRP Report No. 637, Washington, D.C., 2009.

Kohn, S. D., Tayabji, S., Okamoto, P., Rollings, R., Detwiller, R., Perera, R., Barenberg, E., Anderson, J., Torres, M., Barzegar, H. and Thompson, M. Best Practices for Airport Portland Cement Concrete Pavement Construction (Rigid Airport Pavement). No. ACPA No. JP007P, 2003.

Kosmatka, S. H., and William M. L. Design and Control of Concrete Mixtures, EB001, 15th edition, Portland Cement Association, Skokie, Illinois, USA, 2011.

Lederle, R.E. and Hiller, J.E. 2012. "New Warping and Differential Drying Shrinkage Models for Jointed Plain Concrete Pavements Derived with Nonlinear Shrinkage Distribution", Transportation Research Record, No. 2305, pp. 3-13.

Michigan Department of Transportation (Michigan DOT). 2019. Road Design Manual. Michigan Department of Transportation, Lansing, MI.

Michigan Department of Transportation (Michigan DOT). 2020. Capital Preventive Maintenance Manual. Michigan Department of Transportation, Lansing, MI.

Michigan Department of Transportation (Michigan DOT). 2020. Road and Bridge Standard Plans. Michigan Department of Transportation, Lansing, MI.

Michigan Department of Transportation (Michigan DOT). 2020. Standard Specification for Construction. Michigan Department of Transportation, Lansing, MI.

Ministry of Transportation Ontario (Ontario Ministry of Transportation). Pavement Design and Rehabilitation Manual, second edition, Materials Engineering and Research Office, Downsview, Ontario, 2013.

Ministry of Transportation Ontario (MTO). Ontario provincial standards for roads and public works, Volume 1, Ontario, 2021.

<https://www.library.mto.gov.on.ca/SydneyPLUS/TechPubs/Portal/tp/opsViews.aspx>

Minnesota Department of Transportation (Minnesota DOT). 2007. MnDOT Pavement Design Manual, Chapter 5: PCC (Portland Cement Concrete), St. Paul, MN.

Minnesota Department of Transportation (Minnesota DOT). 2015. Standard Plans and Plates, Chapter 5. Minnesota Department of Transportation. St. Paul, MN

Minnesota Department of Transportation (Minnesota DOT). 2018. Network Level Concrete Decision Tree.

Minnesota Department of Transportation (Minnesota DOT). 2019. MnDOT Pavement Design Manual, Chapter 5: PCC (Portland Cement Concrete), St. Paul, MN.

Minnesota Department of Transportation (Minnesota DOT). 2018.  
<https://www.dot.state.mn.us/stateaid/construction/forms/concrete/cold-weather-concrete.pdf>  
<http://www.dot.state.mn.us/materials/concretedocs/coldweather.pdf>

Naik, T.R., Kraus, R.N. and Kumar, R., 2011. Influence of types of coarse aggregates on the coefficient of thermal expansion of concrete. Journal of Materials in Civil Engineering, 23(4), pp.467-472.

NCHRP. Guide for Mechanistic-Empirical Design of New and Rehabilitated Pavement Structures. [www.trb.org/mepdg](http://www.trb.org/mepdg)., National Cooperative Highway Research Program 1-37 A. Washington, DC: Transportation Research Board, National Research Council, 2004.

Popovics, J., Roesler, J., Peterson, C., Salas, A., and Ham, S. High Plastic Concrete Temperature Specifications for Paving Mixtures. Illinois Department of Transportation, FHWA-ICT-11-087. 2011.

Rao, S. Where The Dowel Bars Are. Publican Roads Magazine, Federal Highway Administration, Publication No. FHWA-HRT-05-0006, Vol. 69, No. 1, 2005.

Rens, L. Blowups of Concrete Roads, (Translated from Dutch) Infrastructure, August 2018.

RILEM. 1995. "Creep and shrinkage prediction model for analysis and design of concrete structures - model B3", Draft Recommendation 107-GCS: Guidelines for the Formulation of Creep and Shrinkage Prediction Models, Materials and Structures, Vol. 28., pp. 357- 365.

Roesler, J.R., and Wang. D. 2011. "An Analytical Approach to Computing Joint Opening in Concrete Pavements", Proceedings of the 6th RILEM International conference on Cracking in Pavements, Chicago, IL, pp. 79-87.

Shober, S. The Great Unsealing: A Perspective on Portland Cement Concrete Joint Sealing. Transportation Record 1597, pp. 22-23, 1997.

Shober, S. and Rutkowski, T. S. "The Effect of PCC Joint Sealing on Total Pavement Performance," *Proceedings of the 4<sup>th</sup> ACI World Congress on Joint Sealing and Bearing Systems for Concrete Structures*, 1996.

Simonsen, J. E. Development of Procedures for Replacing Joints in Concrete Pavement. Final Report No. R-1020, Michigan Department of Transportation, 1976.

Smith, K. D., Snyder, M. B., Darter, M. I., Reiter, M. J. and Hall, K. T. Pressure Relief and Other Joint Rehabilitation Techniques. Final Report, Federal Highway Administration, February 1987.

Snyder, M. B., Smith, K. D., and Darter, M. I. Evaluation of Pressure Relief Joint Installations. Transportation Research Record 1215, 1989.

Stott, J. P. and Brook, K. M. Report on a Visit to USA to Study Blowups in Concrete Roads. Road Research Laboratory, Crowthorne, Berkshire, England, 1968.

Sweet, H. S. and Woods, K. B. Evaluation of Aggregate Performance in Pavement Concrete. Joint Highway Research Project. 1948.

Tyson, S. S., and McGhee, K. H. Deterioration of Jointed Portland Cement Concrete Pavements. Virginia Highway and Transportation Research Council, VHTRC 76-R19, 1975.

Van Dam, T. J., Sutter, L. L., Smith, K. D., Wade, M. J., and Peterson, K. W. Guidelines for Detection, Analysis, and Treatment of Materials-Related Distress in Concrete Pavements, Volume 1: Final Report, FHWA Publication FHWA-RD-01-163, 2002a.

Winkelman, T.J., 2004. Open Graded Drainage Layer Performance in Illinois Report No. FHWA/IL/PRR 147, Illinois Department of Transportation, Springfield, IL.

Yoder, E. J., Foxworthy, P. T. Blowups: Still a Problem? Joint Highway Research Project. Purdue University, 1972.

Yu, H.T., Khazanovich, L., and Darter, M.I. 2004. "Consideration of JPCP Curling and Warping in the 2002 Design Guide". 83rd Annual Meeting of the Transportation Research Board, Compendium of Papers, Washington, D.C.