

Optimizing Bridge Abutment Slope Protection at Stream Crossings

James Hambleton, PhD

Northwestern University

WisDOT ID no. 0092-21-02

December, 2022



RESEARCH & LIBRARY UNIT



WISCONSIN HIGHWAY RESEARCH PROGRAM

WISCONSIN DOT
PUTTING RESEARCH TO WORK

TECHNICAL REPORT DOCUMENTATION PAGE

1. Report No. 0092-21-02	2. Government Accession No.	3. Recipient's Catalog No.	
4. Title and Subtitle Optimizing Bridge Abutment Slope Protection at Stream Crossings		5. Report Date December, 2022	
		6. Performing Organization Code	
7. Author(s) Jim Hambleton, Susan-Alexis Brown, Nima Goudarzi, Peng Wang		8. Performing Organization Report No. If applicable, enter any/all unique numbers assigned to the performing organization.	
9. Performing Organization Name and Address Department of Civil and Environmental Engineering Northwestern University Technological Institute 2145 Sheridan Road, Room A236, Evanston, IL 60208		10. Work Unit No.	
		11. Contract or Grant No. 0092-21-02	
12. Sponsoring Agency Name and Address Wisconsin Department of Transportation Research & Library Unit 4822 Madison Yards Way Room 911 Madison, WI 53705		13. Type of Report and Period Covered Final Report January 2021 – December 2022	
		14. Sponsoring Agency Code	
15. Supplementary Notes If applicable, enter information not included elsewhere, such as translation of (or by), report supersedes, old edition number, alternate title (e.g. project name), or hypertext links to documents or related information.			
16. Abstract The goals of this project were to (1) develop guidance in identifying site conditions of over-water bridges which corresponded to performance issues associated with WisDOT's standard method for slope protection, and (2) to develop guidance for alternative protection methods at problematic sites, considering life-cycle costs. An initial hypothesis of scour-related concerns was abandoned, and creeping movement was identified as the most likely cause of loss of slope protection in the majority of cases. This was supported by multiple avenues of investigation, including site visits and computational analysis. Results show a clear indication of slope movement as a direct cause of loss of slope protection, directly resulting from the choice of 1.5:1 (H:V) slopes as a cost-savings measure. However, increased maintenance due to loss of protection does not appear to negate these savings. Continued use of 1.5:1 slopes, with improved nuance to geotechnical considerations that might mitigate the small percentage of bridges requiring such ongoing maintenance due to soil movement, is shown to be a cost-effective standard.			
17. Key Words Bridges, abutments, scour, geotechnical engineering, slope instability		18. Distribution Statement No restrictions. This document is available through the National Technical Information Service. 5285 Port Royal Road Springfield, VA 22161	
19. Security Classif. (of this report) Unclassified	20. Security Classif. (of this page) Unclassified	21. No. of Pages 295	22. Price

Disclaimer

This research was funded through the Wisconsin Highway Research Program by the Wisconsin Department of Transportation and the Federal Highway Administration under Project 0092-21-02. The contents of this report reflect the views of the authors who are responsible for the facts and accuracy of the data presented herein. The contents do not necessarily reflect the official views of the Wisconsin Department of Transportation or the Federal Highway Administration at the time of publication.

This document is disseminated under the sponsorship of the Department of Transportation in the interest of information exchange. The United States Government assumes no liability for its contents or use thereof. This report does not constitute a standard, specification or regulation.

The United States Government does not endorse products or manufacturers. Trade and manufacturers' names appear in this report only because they are considered essential to the object of the document.

Executive Summary

Study Goals, Objectives, and Research Approach

Wisconsin's current standard method of bridge abutment slope protection at stream crossings uses heavy riprap on top of heavyweight geotextile fabric at a 1.5:1 (H:V) slope. The Wisconsin Department of Transportation (WisDOT) has become concerned with a growing awareness in slope failures or transported riprap for these bridges. Slope repairs are expensive and may interrupt traffic for material and equipment delivery. In addition, low clearance beneath bridge decks makes replacing riprap beneath an existing bridge very difficult. Providing shallower slopes may better protect slopes; however, it requires additional bridge length, increasing structure costs.

This study evaluated the effectiveness of slope protection for Wisconsin bridges using the current WisDOT design methodology. Alternative designs to minimize observed failures were considered. A cost comparison of these alternatives led the team to conclude that despite costs and difficulty, maintaining current design standards is likely in the best interests of Wisconsin, with proposed guidelines to minimize the negative impacts of such a slope.

The original objectives were twofold. The first was to develop guidance in identifying site conditions of over-water bridges which corresponded to performance issues associated with WisDOT's standard method for slope protection. The second was to develop guidance for alternative protection methods at problematic sites, considering life-cycle costs. The research team initially considered combinations of hydraulic, geotechnical, and construction factors may also play a role in the observed abutment protection performance. Thus the team's first aim was to establish a cause-effect relationship between such combinations and the severity of slope issues, using both statistical and numerical analysis. Based on this approach, the research team outlined the method of accomplishing each of the requested tasks. An abbreviated summary is provided here, including discussion of the change in research focus which occurred after completion of the site visits.

Synthesis of current research and literature, as well as a review of relevant specifications was performed (*Task 1*). This work summarized knowledge for the evaluation of causes and countermeasures of abutment protection for bridges at stream crossings. Following the literature review, identification of Wisconsin bridges with heavy riprap slope failure was undertaken, with the goal of documenting such bridges for quantification of conditions which may have led to such failure (*Task 2*). The aim was to collect information to gauge the severity, cause, and type of slope protection issues, gather expense information for life-cycle cost analysis, and initiate storage of collected data in a GIS database. Initial information was collected on the basis that hydraulic scour was the primary mode of slope failure for the identified bridges. As will be discussed in the following sections, further information gathering was needed to account for a shift in the observed failure mode, and the use of a GIS database was considered unnecessary (as the analyzed conditions did not trend geographically, as first presumed).

A survey was conducted regarding the use of various slope failure countermeasures and their relative success in the upper Midwest, consisting of Illinois, Indiana, Iowa, Michigan, and Minnesota (*Task 3*). The initial survey gathered both qualitative and quantitative information on the type and performance of countermeasures in these states. Survey results indicated the surrounding states generally utilized riprap in the manner of WisDOT, and experienced comparatively minimal protection failures.

Site visits were planned to a selection of bridges with highly critical conditions (*Task 4*). As this study did not include any experiments, this was critical to allow for qualitative assessment of the cause of slope failures. The team was surprised to see that the majority of sites visited exhibited slope movement originating at the top or middle of the slope, and that few of the sites showed any erosion at the base of the slope, indicating that the movement was not due to loss of soil in that region. Discussion with WisDOT engineers during the site visits gave the impression that the majority of critical slopes exhibited a similar movement, originated at the top rather than the base, signalling that hydraulic scour may not be the source of the majority of riprap failures, as presumed during the original proposal.

Further discussion amongst the research team and consultant Ciorba Group (who led the site visits), as well as WisDOT engineers, confirmed initial supposition that the primary mode of failure of most concern to WisDOT is creeping (gradual) slope movement, originating at the top or middle of the abutment slope, rather than hydraulic scour, originating at the toe. That is to say, the foreslopes of the abutments were experiencing displacement due to an inability to hold their own weight, in combination with the external loadings and hydrological conditions. This conclusion initiated a shift

in focus of the project. If slope instability was the root cause, then many of the planned analysis would not be applicable to the project. Preliminary computational analysis (as part of *Task 5*) was performed to verify the possibility, showing indeed that the typical designed geometry of abutments over water has a very low factor of safety for typical Wisconsin soil.

To address this shift in focus, the research team modified the research approach for the remaining tasks. Changes included: removing the development of a GIS database from proposed tasks; a modified query for identifying the total number of bridges in the state which exhibited slope instability; shift in analysis from hygro-hydro-geotechnical to pure geotechnical computational analysis and review of the Highway Structures Information System (HSI) for relevant bridge failures; a simplified life-cycle cost analysis which reflected the reduced scope of failure analysis. HSI provides information on bridge construction, location, design characteristics, river hydraulics, etc., as well as tracking construction documents, inspection reports, and other relevant documentation. The summarized recommendations resulting from this modified approach are presented as part of *Task 7*.

Conclusions, Recommendations, and Implementable Results

As noted, the initial hypothesis of scour-related concerns was found not to be the primary mode of failure, but rather slope instability in the form of creeping slope movement was identified as the more likely cause of loss of slope protection. This was supported by multiple avenues of investigation. First, information drawn from bridge inspections indicated a statewide trend of creeping movement, as opposed to sudden failures after high rainfall events (which was primarily occurring in the southwest region but not elsewhere; moreover, the southwest region also experienced the same creeping concern). Second, a survey sent to the DOTs of surrounding states highlighted Wisconsin as unique in defaulting to a 1.5:1 (H:V) slope for over-water bridges, as opposed to 2:1 slopes noted by all surrounding Midwest states. Indeed, surrounding states stated minimal concerns for the use of riprap as slope protection, indicating that neither scour or nor slope instability plays a significant role in bridge maintenance. Computational analysis supported the shift to a flatter slope for increased stability and subsequent reduction in maintenance needs.

Site visits further supported this conclusion, whilst also providing more information about the current state of over-water bridge abutments in general. As per the WisDOT bridge manual, most riprap-covered slopes are designed to be on a 1.5:1 (H:V) slope, where the top of the riprap is designed to be 2'-6" minimum from the bottom of abutment concrete, with a flat berm at the top of the slope. However, no observed bridges showed a berm of riprap, and the measured slopes were found to be on average much flatter than the 1.5:1 (H:V) called out on plans (and assumed as built). Additional concerns due to poor drainage were present in some abutments as well, indicating seepage and related hydrological effects may be of concern. Further computational analysis supported such conclusions.

A review of the HSI database for all over-water bridges estimated that 2% of current in-use bridges in Wisconsin experience slope instability and related loss of abutment protection. Furthermore, this trend holds even for the most recent three decades, only decreasing to 1.9% of bridges built since 1990, indicating the failure is seen early on in the structure's lifespan.

A simplified bridge design was used to estimate the effect on overall cost of a steeper slope, comparing the savings due to a shorter superstructure with the assumed increased maintenance costs. It was seen that despite the need for primary and secondary repairs related to abutment foundation protection, replacement of lost slope protection, and serviceability of the roadway approach, the cost savings of a steeper abutment slope are greater than the associated maintenance costs. A slope failure rate of greater than 15% would be required, based on assumed line item costs and a simplified bridge design, for 2:1 slopes to result in equivalent costs. It is thus recommended that no change be made to the prescribed slope of over-water bridges in Wisconsin.

However, as the Wisconsin Bridge Manual does provide situational guidance for when 2:1 slopes should be implemented, this study suggests that increased nuance in the selection criteria would reduce even further the observed rate of failure, to reduce maintenance costs associated with replacement of riprap and protection of abutment foundations. These recommendations focus on characterization of abutment fill soil, to ensure correct drainage and strength. A secondary focus is on the choice of remediation material used for protection of exposed abutments due to slope movement. Site visits and discussions with WisDOT engineers showed concrete slurry as the common choice for gap 'repair'. However, it is recommended that a lightweight material such as expanding foam would equally serve the intended purposes without contributing to further slope movement due to added weight.

Overall, the completed study shows clear indication of slope instability as a direct cause of loss of slope protection, and directly resulting from the choice of 1.5:1 (H:V) slopes as a cost-savings measure. However, increased maintenance does not negate these savings, and in conclusion this study recommends continuing the use of 1.5:1 slopes, with improved nuance to geotechnical considerations that might mitigate the small percentage of bridges requiring such ongoing maintenance due to soil movement.

Acknowledgements

This project was made possible through the combined effort of many. Key contributors from Northwestern University, in alphabetical order, are Susan-Alexis Brown, Gianluca Cusatis, Nima Goudarzi, Jim Hambleton, Christopher Lee, Peng Wang, and Hao Yin. Special thanks are due to Dr. Goudarzi for getting the project off the ground and to Ms. Brown for championing the project after Nima's departure. Mr. Wang provided sustained effort over the life of the project, and his contributions are gratefully acknowledged. From Ciorba Group, contributions from Rami Asfahani, Salvatore Di Bernardo, and Tony Wolff are deeply appreciated. The research team extends heartfelt thanks to the Project Oversight Committee and support staff from WHP and WisDOT for providing technical input and administrative assistance. Charles Martell and Sarah Cowles from Northwestern University also provided administrative assistance necessary to keep the project running smoothly.

Table of Contents

Disclaimer	ii
Executive Summary	iii
Study Goals, Objectives, and Research Approach	iii
Conclusions, Recommendations, and Implementable Results	iv
Acknowledgements	vi
Table of Contents	vii
List of Tables and Figures	viii
Introduction	1
I1 Original research objectives	1
I2 Modified research approach	2
Task Outcomes	4
T1 Synthesis of current research & literature and specification review	4
T1.1 Background	4
T1.2 Parameters effecting scour depth	4
T1.3 Scour processes and failure mechanisms	6
T1.4 Abutment scour countermeasures	10
T1.5 Summary of literature review	10
T2 Identification and documentation of Wisconsin bridges with heavy riprap slope failure issues	11
T2.1 Identification of bridges with critical conditions	11
T2.2 Estimation of total percentage of undermined over-water bridges	12
T2.3 Collection of unit costs for use in life-cycle cost assessments	13
T3 Surveillance of current abutment slope protection practices in upper Midwest states	14
T3.1 Survey questions	14
T3.2 Key survey results	14
T4 Site visits and qualitative field review of bridges with heavy riprap slope failures	15
T4.1 Summary of observations	15
T4.2 Discussion of bridge conditions	17
T5 Assessment of the extent and causes of identified concerns in preceding tasks	28
T5.1 Assessment methods	28
T5.2 Verifying modelling approach using inclinometer data	28
T5.3 Investigation of failure mitigation and protections measures	30
T6 Life-cycle costs assessment according to slope inclination and protection method	38
T6.1 Single bridge cost estimates	38
T6.2 Associated long-term costs for Wisconsin	40
T7 Final recommendations and guidelines	41
Conclusions	42
C1 Key conclusions on the current state of abutment protection	42
C2 Proposed guidelines for future over-water bridge design in Wisconsin	43
C3 Potential points of further research	43
Appendix	45
A1 Identified bridges of concern	45
A1.1 Slope instability estimates	45
A1.2 Critical slope failure	45
A2 Inclinometer monitoring data	46
A3 Supporting documents	46

List of Tables and Figures

Tables

1	Bridges selected for site visits	11
2	Table 5.4-23 Stream Crossing Structures (WisDOT 2020)	13
3	Unit price estimates	13
4	Cost of material for 2:1 slope	38
5	Cost of material for 1.5:1 (H:V) slope	38
6	Maintenance histories for four bridges with recent secondary maintenance	39
A.1	Bridges identified as having critical slope failure concerns	45

Figures

1	Photos from a Utica resident document the aftermath of the collapse of the New York State Thruway bridge over the Schoharie Creek in 1987 [29]	5
2	Diagram of types of bridge scour: (a) General side view [adapted from Melville and Coleman [27], and (b) Top view of general components of scour at the location of a bridge.	6
3	Schematic view of the flow field and local scour components at (a) A circular pier (adapted from Melville and Coleman [27]), and (b) A vertical abutment (adapted from Kwan [20]).	7
4	Multi-stage collapse process of a spill-through abutment in a compound channel due to scour associated with scour condition I: (a) Hydraulic scour of the main channel bed sediment leading to riverbank instability and failure; (b) failure of the abutment embankment face. Under this condition, the floodplain is much less erodible than the main-channel sediments [adapted from NCHRP].	8
5	The two-step scour-induced collapse process of a wing-wall abutment associated with scour condition I: (a) Hydraulic scour of the main-channel bed sediment which leads to riverbank instability and failure; (b) Failure of the channel bank and the approach embankment face [adapted from NCHRP].	8
6	Collapse process of a wing-wall abutment due to the erosion of embankment soil beneath the abutment pile cap: (a) before scour; (b) scour develops under the pile cap; (c) embankment soil is sucked from the beneath of the pile cap forming a cavity in the embankment [adapted from NCHRP].	8
7	The scour-induced collapse process of a spill-through abutment in a compound channel associated with scour condition II: (a) hydraulic scour of the floodplain; (b) failure of the approach embankment face. Under this condition, the floodplain is more or less erodible. Also, the collapse of the embankment soil and armor layer into the scour hole modifies the scour area [adapted from NCHRP].	9
8	(a) Full washout of the approach embankment exposes the abutment foundation, which can result in the abutment structure's scour process as if the abutment were a form of a pier; (b) Impingement against a long approach embankment resulting in erosion of the embankment [adapted from NCHRP].	9
9	(a) Schematic of submerged vanes used to stop lateral migration of an approach channel and to narrow the width of the bridge opening [adapted from NCHRP]; (b) An example of submerged vanes [retrieved from Fitzpatrick et al. [11].	11
10		12
11		12
12	Bridges selected for site visit	15
13	Observed slopes compared to a design slope of 1.5:1 (H:V), and a mean slope of 2.25:1.	16
14	Observed slopes compared to a design slope of 1.5:1 (H:V), and an average current slope of 1.98:1 (not including grouted abutments, or bridges exhibiting purely scour failures). Orange slopes indicated abutments without any repair attempts.	16

15	B-52-114 a) South abutment, overall view, b) Zoomed in photo of wide crack in closure pour, c) North abutment concrete pour repair noted with a gap between the abutment and pour repair indicating movement of repair. Abutment stem (typical for both abutments) is 8 degrees out of plumb inwards towards the pier, d) Upstream at center pier. Blue arrows indicate water flow.	17
16	B-12-102 a) South abutment, overall, b) Erosion along the south abutment	18
17	B-12-102 a) Southwest corner noted with localized erosion b) Exposed pile, at location indicated in Figure 17a	18
18	B-12-076 a) Middle pier with retrofit, b) Water marks near the east abutment indicating the flow has diverged away from the east abutment	19
19	B-12-076 a) Looking downstream, b) Riprap scoured at north end of west abutment	19
20	B-12-076 a) Filter fabric is caught by the existing piles and tearing/damaging the fabric, b) Typical fractures noted in the riprap rocks	20
21	B-62-017 a) North abutment and north pier overall b) Corrective concrete slurry at north abutment	20
22	B-62-017 Photos showing abutment under-minding at the southwest end.	21
23	B-35-063 a) North abutment overall, b) Riprap repair near east end of north abutment	22
24	B-35-063 a) Steep change in slope at northeast wingwall, b) Gap between abutment and side riprap along wingwall	22
25	B-35-62 and B-35-63	23
26	B-35-062 a) Gap between bridge and riprap at east end of north abutment, b) West end of north abutment	23
27	B-35-062 a) Riprap near west half of north abutment, b) Hole noted near west half of abutment	24
28	B-35-062 a) Riprap existing condition at north abutment, b) Riprap at north abutment from bottom of riprap	24
29	B-43-018 a) Looking south from bridge, b) Gap at north abutment of riprap	25
30	B-43-018 a) Scour near center half of north abutment. Red dots on riprap indicates riprap elements surveyed, b) Inclinometer device	25
31	B-43-018 a) Scour under the west wingwall, b) Drain relative location compared to wingwall and abutment	26
32	B-58-075 a) Looking east along the bridge, b) Exposed piles under the abutment due to noted scour/erosion	27
33	B-58-075 Movement monitoring	27
34	B-58-075 a) Concrete slurry repair with sand bags left in place attached to the repair and adding dead weight due to soil erosion under repair, b) Scour under the abutment	28
35	Simulation geometry and initial soil properties for B-58-75	29
36	Benchmark analysis of B-58-75 for simulation validation. a) result of analysis of B-58-75 without geotextile fabric, b) simulated as-built dry conditions	29
37	Consideration of varying water table levels. a) failure with a water table 0 ft above slope base, b) failure with a water table 3 ft above slope base, c) Failure with a water table 5 ft above slope base	31
38	a) Analysis of reduce 2:1 slope, b) consideration of grouted riprap	32
39	a) Simulation of concrete fill used to protect exposed abutment piles, b) simulation of extended riprap toe, c) alternative toe shape	33
40	Preventative design using a) slope piles, and b) soil stabilization	34
41	Seepage analysis with a) zero water table differential, b) 12 ft water table differential	35
42	Rain infiltration a) immediately after rainfall, and b) 5 days after rainfall	36
43	IL slope-wall treatment a) dry, and b) with elevated water levels	37
44	Bridge schematic, with a width of 40 ft.	38
1	WisDOT Bridge Manual Section 15.2 <i>Stream Crossings</i>	41
2	Recommended changes for Section 15.2	42
A.1	Inclinometer data at bridges a) B-58-75 and b) B-43-18	46

Introduction

Wisconsin's current standard method of bridge abutment slope protection at stream crossings uses heavy riprap on top of heavyweight geotextile fabric at a 1.5:1 (H:V) slope. The WisDOT has become concerned with a growing awareness in slope failures or transported riprap of these bridges. Slope repairs are expensive and may interrupt traffic for material and equipment delivery, which makes replacing riprap beneath an existing bridge very difficult. Providing shallower slopes may better protect slopes; however, it requires additional bridge length, increasing structure costs. This study evaluated the effectiveness of slope protection for Wisconsin bridges using the current WisDOT design methodology. Alternative designs to minimize observed failures were considered. A cost comparison of these alternatives led the team to conclude that despite costs and difficulty, maintaining current design standards is likely in the best interests of Wisconsin, and proposed guidelines may be considered to minimize the negative impacts of such a slope.

I1 Original research objectives

The original objectives were twofold: (1) to develop guidance in identifying site conditions of over-water bridges which corresponded to performance issues associated with WisDOT's standard method for slope protection and (2) to develop guidance for alternative protection methods at problematic sites, considering life-cycle costs.

The following specific objectives were defined based on the request for proposal (RFP) by WHRP:

- Determine the severity, causes, and types of slope protection issues in Wisconsin by analyzing qualitative and quantitative factors believed to trigger failure in the slope protection.
- Plan and oversee comprehensive surveys providing useful information about alternative slope protection strategies practiced successfully at various other states.
- Perform Life-Cycle Cost Analysis (LCCA) to provide information about the optimum abutment slope protection strategy with maximum service life and minimum life-cycle cost.
- Update the WisDOT bridge manual with consistent recommendations and guidelines from this study.

The research approach was designed to take into consideration the feasibility of altering the current standard design approach by WisDOT, which is primarily defined by the use of heavy riprap (generally smooth) and explicit berm and toe design. The research team initially considered combinations of hydraulic, geotechnical, and construction factors may also play a role in the observed abutment protection performance. Thus the team's first aim was to establish a cause-effect relationship between such combinations and the severity of slope issues, using both statistical and numerical analysis. Based on this approach, the research team outlined the method of accomplishing each of the requested tasks. An abbreviated summary is provided here, including discussion of the change in research focus which occurred after completion of the site visits.

Synthesis of current research and literature, as well as a review of relevant specifications was performed (*Task 1*). This work summarized knowledge for the evaluation of causes and countermeasures of abutment protection for bridges at stream crossings. The literature survey focused on recent publications, reports, and practice-ready journal articles published by federal and non-federal agencies. In addition, work during this task assessed current strategies related to scour countermeasures, relying on survey responses from the Department of Transportation office of a number of U.S. states regarding some detailed information clarifying adaptivity of state's bridges to one or more protection approaches, successfully implemented countermeasures, etc.

Following the literature review, identification of Wisconsin bridges with heavy riprap slope failure was undertaken, with the goal of documenting such bridges for quantification of conditions which may have led to such failure (*Task 2*). The aim was to collect information to gauge the severity, cause, and type of slope protection issues, gather expense information for life-cycle cost analysis, and initiate storage of collected data in a GIS database. Initial information was collected on the basis that hydraulic scour was the primary mode of slope failure for the identified bridges. As will be discussed in the following sections, further information gathering was needed to account for a shift in observed

failure mode, and the use of a GIS database was considered unnecessary (as the analyzed conditions did not trend geographically, as first presumed).

To investigate possible similarities in site conditions among neighboring states, a survey was conducted regarding the use of various slope failure countermeasures and their relative success in the upper Midwest, consisting of Illinois, Indiana, Iowa, Michigan, and Minnesota (*Task 3*). The initial survey gathered both qualitative and quantitative information on the type and performance of countermeasures in these states. A second step was planned to gather complementary information on construction factors, flow, and stream bed information for critical bridges. However, initial survey results indicated the surrounding states generally utilized riprap in the manner of WisDOT, and experienced comparatively minimal protection failures. These findings, in association with a later shift in focus of the project (detailed in the following section) and discussions with the WisDOT POC and engineers, led the researchers to choose to not conduct this second step.

I2 Modified research approach

Site visits were planned to a selection of bridges with highly critical conditions (*Task 4*). As this study did not include any experiments, this was critical to allow for qualitative assessment of the cause of slope failures.

The team was surprised to see that the majority of sites visited exhibited slope movement originating at the top or middle of the slope, and that few of the sites showed any erosion at the base of the slope, indicating that the movement was not due to loss of soil in that region. Discussion with WisDOT engineers during the site visits gave the impression that the majority of critical slopes exhibited a similar movement, originated at the top rather than the base, signalling that hydraulic scour may not be the source of the majority of riprap failures, as presumed during the original proposal.

Furthermore, in the cases where hydraulic scour did appear to play a role in riprap failure, it was determined to be due to changes in the river orientation, a behavior which cannot be prevented or mitigated in most cases, and which is estimated to represent a small portion of overall streams crossings.

Further discussion amongst the research team and consultants Ciorba Group (who led the site visits), as well as WisDOT engineers, confirmed initial supposition that the primary mode of failure of most concern to WisDOT was slope instability, originating at the top or middle of the abutment slope, rather than hydraulic scour, originating at the toe. This conclusion initiated a shift in focus of the project. If slope instability was the root cause, then many of the planned analysis would not be applicable to the project. Preliminary computational analysis (as part of *Task 5*) was performed to verify the possibility, showing indeed that the typical designed geometry of abutments over water has a very low factor of safety, for typical Wisconsin soil.

To address this shift in focus, the research team modified the research approach for the remaining tasks. First, it had been previously assumed that geographic trends would be identifiable based on quantification of site conditions. However, abutment slope soil is generally not characterized during construction, and regional contractors may source the soil from a variety of locations, based on cost and ease of transportation. As such, it would not be possible to identify trends in the severity of protection failure based on soil properties or location. Thus the use of a GIS database was concluded to be unnecessary (with respect to *Task 2*). Furthermore, a modified query was used to identify the total number of bridges in the state which exhibited slope instability, via the Highway Structures Information System (HSI). Previously, hydraulic information was the focus of the search, however with the modified approach, the research team focused on identifying those bridges with slope repairs or abutment undermining which appeared to be caused by slope instability. This was a brute-force qualitative review, however the team is confident in the overall trend of the numbers.

The original proposal included a computational assessment of the extent and causes (hydrologic, hydraulic, and geotechnical) of the identified modes of failure (*Task 5*), with a focus on identifying combinations of factors which intensify such failure. The team planned to work with Ciorba Group as consultants to perform FEA and SFI (solid-fluid interaction) simulations, as well as numerical parametric studies. With the shift in focus to soil stability, it was decided that 2D limit equilibrium methods (LEM) would be more suitable; combined with a focus on the geotechnical aspects, this work was moved in-house to be performed by the Northwestern research team.

Finally, the approach used for the life-cycle cost analysis was modified (*Task 6*). The original cost analysis would consider factors as design, construction, inspection, monitoring, different level of

maintenance and repair, and compulsory construction during the bridge service life must be taken into consideration. However, for the case of slope instability, such a range of options are not necessary. Simply, either the slope is unstable (in which case either the design or maintenance should account for this by some set additional cost), or it is not. This is primarily due to the fact that for most observed cases, slope instability will not lead to a critical failure, but rather slow movement of the abutment protection over the lifetime of the structure. This may be easily accounted for during routine maintenance. Additionally, as will be seen, modification to standard over-water abutment design is not cost-effective for the state in these cases (*Task 7*), which simplifies the need for an optimized site-specific analysis.

Task Outcomes

T1 Synthesis of current research & literature and specification review

Scour is considered a significant cause of all bridge failures throughout the world. However, more than 70% of FHWA bridges have not been properly designed to withstand scour-induced instabilities, despite many having been declared “scour critical”. Work summarized in **Task 1** offers a comprehensive review of the up-to-date work on bridge abutment scour. First, a general introduction about current scour problems is presented. Then, all the possible parameters affecting scour depth are reviewed. Following, the abutment scour failure mechanism is analyzed. Finally, various countermeasures developed for bridge abutment scour are summarized.

It should be noted that the literature review was completed prior to the modification of the research objectives. Thus, the goals of the review do not reflect the final needs of the project. While additional literature review was performed following adjustment of the project aims, it was decided that a review of similar scale to the initial work was not necessary, and is thus not presented here. However, the initial review targeting hydraulic scour and similar failures was comprehensive, and remains a valuable summary of common over-water bridge conditions. A full write-up of the review is provided in the Appendix.

T1.1 Background

Displacement of riverbed substrate around bridge abutments and piers, called *scour*, introduces significant risks in the life performance and overwhelming costs in maintaining a large number of stream-crossing bridges and is considered a significant cause of all bridge failures throughout the world. In the US, while more than 80% of 616,000 archived highway bridges in the National Bridge Inventory (NBI) of Federal Highway Administration (FHWA) have been constructed over waterways, and over 21,000 having been declared “scour-critical”, more than 70% have not been designed properly to withstand scour-induced instabilities [2]. As a result, a large percentage of all bridge failures in the US can be directly or indirectly attributed to the substructure scour, mainly during short-term floods and other peak flow events, as detailed by Flint et al. [12]. More precisely, the literature suggests that hydraulic events, including foundation undermining, scour, and flooding, are the leading causes of total or partial bridge failures in the United States with an approximate annual frequency of 1/5000 [3, 7].

Two of the most iconic bridge failures due to scour in the United States history are

- Custer Creek train wreck as the worst rail disaster in Montana history, occurred on June 19, 1938, when the foundation of the bridge AA-438 washed away by a flash flood. Consequently, the bridge structure collapsed beneath the Milwaukee Road’s Olympian as it crossed the Custer Creek river near Saugus, Montana, killing about 47 people.
- Schohaire Creek Bridge’s failure over the Schohaire Creek near Fort Hunter and the Mohawk River in New York State on April 5, 1987, due to the foundations’ scour-induced failure after record rainfall. Unfortunately, the collapse caused nine casualties and one missing but served as the motivation for improving bridge design and inspection procedures with the New York State and beyond. Figure 1 presents some aftermath photos of this tragedy.

These events provide insight into the potential consequences of this behavior. It is understood that scour is a complicated process which could result into many structural instabilities. It might occur any time, especially during prolonged flooding. Thus, it is crucial to differentiate the frequency, extent, and costs associated with failure of individual components of bridges’ substructure due to scour to gain insight on the required level of comprehensiveness of countermeasure design programs. This task presents a comprehensive review of the past work on bridge abutment scour, including parameters affecting scour depth, scour process and failure mechanism and countermeasures.

T1.2 Parameters effecting scour depth

Scour depth is the main index to identify the scour condition and forecast the possible catastrophic failures of bridges. Thus, the parameters affecting scour depth are very significant to preventing scour failure. Barbhuiya and Dey [4] classified the parameters involved in the scour phenomenon at bridge abutments. Some of these parameters are discussed in the following sections.



Figure 1: Photos from a Utica resident document the aftermath of the collapse of the New York State Thruway bridge over the Schoharie Creek in 1987 [29]

Parameters relating to the geometry of the channel, including width, cross-sectional shape, and slope: The geometry of the cross-section of a river is a function of its geographical location, the characteristic of its bed and banks sediments, and its catchment area characteristics. Melville and Ettema [26] conducted some systematic investigations of channel geometry’s effect on scour depth for an abutment located in a compound channel consisting of both floodplain and main channel. In this study, the impact of the channel geometry on the depth of scour has been represented by a multiplying factor K_G defined as the ratio of the scour depth for an abutment in a compound channel to the scour depth for an abutment located in a rectangular channel with overall width and depth equal to those of the compound channel and main channel of the compound section, respectively. Generally, K_G depends on the shape, size, and abutment length with respect to the floodplain width and the roughness of the main channel and floodplains. In another study, Sturm and Janjua [36] considered the discharge contraction ratio M in the equation of the scour depth as a representative of the effect of channel geometry. They showed that as the flow passes through the bridge contraction, M could represent the redistribution of flow between the main channel and floodplains. Cardoso and Bettess [6] studied the influences of the channel geometry on scour depth by extending the length of abutment up to the edge of the main channel. Their results were in compatibility with recommendations made by Melville and Ettema [26] that the abutment scour on floodplains can be approximated by calculation for scour depth in rectangular channels with assuming an imaginary boundary that separates the flow in the main channel from that in the floodplain. However, [6] found that when the scour hole extends into the main channel, the required time to the equilibrium scour is shorter than that when the scour hole is limited to the floodplain.

Parameters relating to the abutment, including size, shape, orientation with respect to the main flow, and surface condition: The equilibrium scour depth is highly influenced by the shape of the abutments. Abutments with streamlined bodies such as semicircular (SC), spill-through (ST), and wing-wall (WW) can produce strong turbulent vortexes. As a result, when these shapes of abutments are used, relatively large scour depth at a blunt obstruction is expected. According to existing experimental data provided by different researchers (e.g., [9, 14, 23, 39]), vertical wall abutments produce larger scour depths in comparison with SC and WW. Moreover, the angle of attack defined as the angle of approaching flow with respect to the abutment alignment is another of the most influential parameters affecting scour depth. The effect of abutment alignment on the scour depth can be included in design equations using an alignment factor K_θ as first introduced by Melville and Ettema [26]. According to Melville and Ettema [26], the alignment factor is only applicable to longer abutments ($l/h \leq 3$) since the alignment effects for short abutments ($l/h \leq 1$) having $K_\theta = 1.0$, are negligible. At last, two other well-studied abutment geometrical properties influencing the maximum scour depth are abutment length and contraction ratio (as the inverse of opening ratio). According to Kandasamy [16], the increase in the length of an abutment affects the scour depth through its direct contribution to scour depth calculations and the decrease of the opening ratio. The contraction ratio has been frequently used in scour depth calculations [14, 15, 30, 41].

Parameters relating to the bed sediment such as median size, particle size distribution (PSD), mass density, angle of repose, and cohesiveness: Like all other discrete granular materials, the bed sediments’ characteristics are primarily influenced by their particle size distribution (PSD). The most widely used grain size parameters used in sedimentology are median sediment diameter d_{50} (or simply d) and geometric standard deviation $\sigma_g = (d_{84}/d_{16})^{0.5}$ as a measure of uniformity

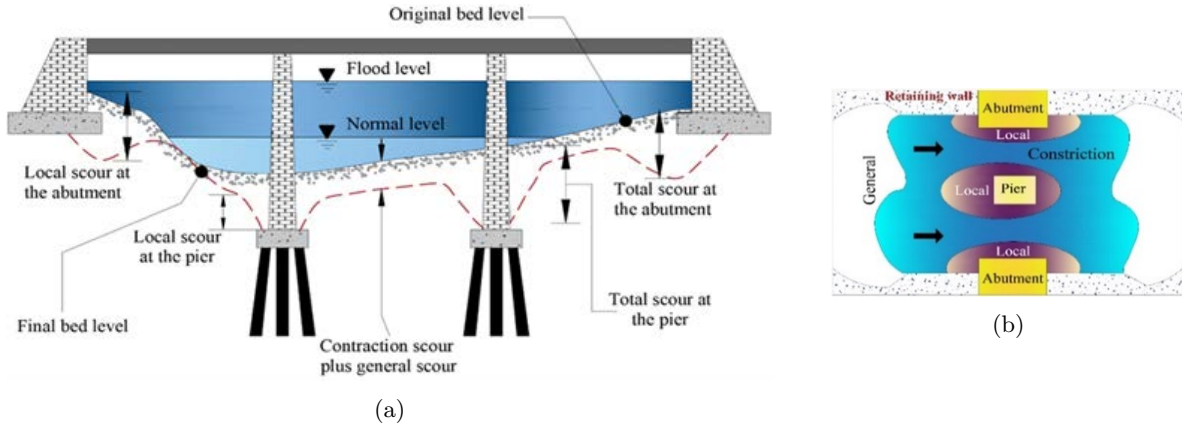

Figure 2: Diagram of types of bridge scour: (a) General side view [adapted from Melville and Coleman [27]], and (b) Top view of general components of scour at the location of a bridge.

in the bed sediment where d_{84} is the 84% and d_{16} is the 16% finer particle diameters in PSD analyses. Experimental results by Gill [15] for two sediment sizes of $d = 1.52$ and 0.914 mm indicated that for the same ratio of critical shear stress of sediment particles to bed shear stress of approaching flow (i.e., $\tau_0/\tau_c < 1$), scour depth is larger for coarse sediments than that caused by fine sediments. However, Gill [15] stated that if τ_0 is kept constant, fine sediments can produce greater scour depths. Findings by Wong [39] from experiments on wing-wall, spill-through, and semicircular abutments, indicated that scour depth increases with the increase of bed sediment size for a constant value of τ_0/τ_c (which is close to unity). As indicated by Dey and Barbhuiya [8], the effect of sediment gradation on scour depth is pronounced for nonuniform sediments meaning that the scour depth reduces significantly due to the formation of some armor layers in scour holes.

Parameters relating to the approaching flow condition, including mean flow velocity, flow depth, shear velocity, and roughness: Conventionally, the effect of approaching flow velocity U is represented in scour prediction relationships by flow Froude number F_r or shear velocity u_* . The Froude number has been frequently used in scour depth analyses [13, 14, 30, 40, 41]. In addition, experimental results obtained by [15, 16, 38, 39] suggest that for a constant value of the shear velocity ratio u_*/u_{*c} (as the ratio of the shear velocity of approaching flow to the critical shear velocity of sediment particles), the maximum scour depth increases at a decreasing rate with the increase in approaching flow depth. According to Kandasamy [16], for shallow flow depths, the scour depth is independent of the abutment length l but increases proportionally with h and for intermediate flow depths, the scour depth depends on both l and h .

T1.3 Scour processes and failure mechanisms

Scour types and local scour processes: According to Richardson and Davies [32], total scour at a bridge site can be generally divided into three major constituents including: (a) Aggradation or degradation as long-term changes in the elevation of the streambed caused naturally or induced by human interference can affect the river's reach near the bridge structure. (b) Contraction scour as the descent of materials from the riverbed and/or across all or most of the flow channel width due to the contraction of the normal flow by natural contractions or human-made contractions such as highway embankments and bridge piers. (c) Local scour as the displacement of the riverbed material from around bridges' abutments, piers, spurs, and embankments due to the acceleration of flow itself and destruction activities by vortexes generated from flow around natural or human-made hydraulic barriers. Figure 2 schematically presents the types of possible bridge foundation scour.

Local scour is a complex 3-D process that occurs when the water flow encounters a hydraulic barriers such as bridge abutments and piers. During local scour at a pier, an acceleration of a downward flow appears in the pillar's front face, which generates a pressure gradient. This gradient causes a downward vertical current toward the bottom of the channel, impacting the at-rest bed materials and forming a very localized erosion (scour hole) around the pillar's base, which can cause its unfavorable subsidence and/or rotation. Upon forming the scour hole, the direction of the downward flow changes to the

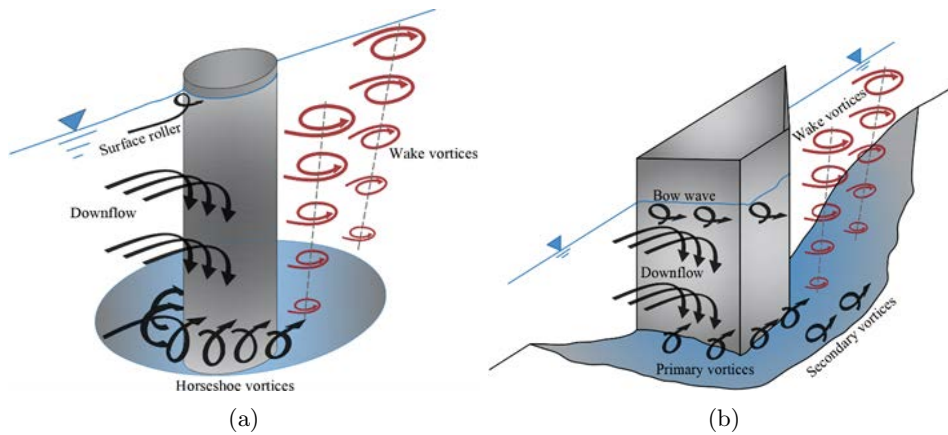

Figure 3: Schematic view of the flow field and local scour components at (a) A circular pier (adapted from Melville and Coleman [27]), and (b) A vertical abutment (adapted from Kwan [20]).

stream's surface, where it acquires a rotary movement that creates some horseshoe vortices that can drag the bed material towards the areas adjacent to the pier and downstream. Accordingly, the horseshoe-shaped vortices are the byproduct of the scour initiation and not its underlying cause. A significant property of horseshoe vortices is that they can grow in size and intensity with the erosion depth increase. Consequently, the vertical current towards the bed of the channel increases to intensify the erosion. In this way, the scour hole grows continuously until reaching a maximum or equilibrium depth. Additionally, as the flow separates to the pier's sides, some wake vortices are created at its downstream, causing all raised and transported sediments to accumulate downstream of the pier. Figure 3a presents the mechanism of the local scour around a circular bridge pier. Similar to local scour at piers, some wake vortices are formed downstream due to the separation of the flow upstream and downstream of the abutment corners. The wake vortices that drift downstream due to the main flow act like small tornadoes which lift sediments from the bed. However, these wake vortices are less potent than the primary vortices. The main components of local scour at a wing-wall abutment, as identified by Kwan (1988), are shown schematically in Figure 3b.

Abutment failure mechanisms: According to Lagasse et al. [22], the variations in the flow field and boundary susceptibility to erosion can be used to classify a series of failure-inducing scour conditions for bridge abutments under which specific locations of scour localization are expected. These conditions are reviewed as follows.

Condition I: Scour destabilization of the main channel banks near the abutment placed close to the bank. It is recognized that compared to the bed of the main channel, the floodplain is relatively resistant to erosion. Figure 4a illustrates a multi-stage failure process for a spill-through abutment due to scour leading to the geotechnical failure of the main channel banks and the abutment adjoining embankment. In this case, the hydraulically induced failure of the main-channel bed triggers the channel bank's geotechnical instability and collapse. As the bank becomes unstable, it undercuts the abutment embankment and its local collapse, and as a result, embankment and bank soil and possibly their attached protective riprap layer start to collapse into the scour hole, as shown in Figure 4b. For the wing-wall abutments, which are located within the bank of the main-channel, in addition to flow contraction, several other erosion processes can lead to the failure of the bank of the main-stream channel and the approach embankment. In this case, the local flow field emerged due to abutments' presence can result in local scour at the abutments' vicinity, as shown in Figure 5a. As the scour hole grows, the channel bank and the abutment embankment face collapse into the scoured area, as shown in Figure 5b. In the case of wing-wall abutments, it is also common to encounter the exposure of piles under the pile cap supporting the abutment and erosion of the riverbank and embankment soil from the beneath of the pile cap and in-between the piles, as shown in Figure 6.

Condition II: Scour of the floodplain around an abutment wall set back from the main channel. It is recognized that the scour at the floodplain usually occurs near and slightly downstream of the abutment. Under this condition, the scour hole can locally destabilize the embankment side slope, which can cause the embankment soil and the protective riprap layer to slide into the scour hole, as shown in Figure 7.

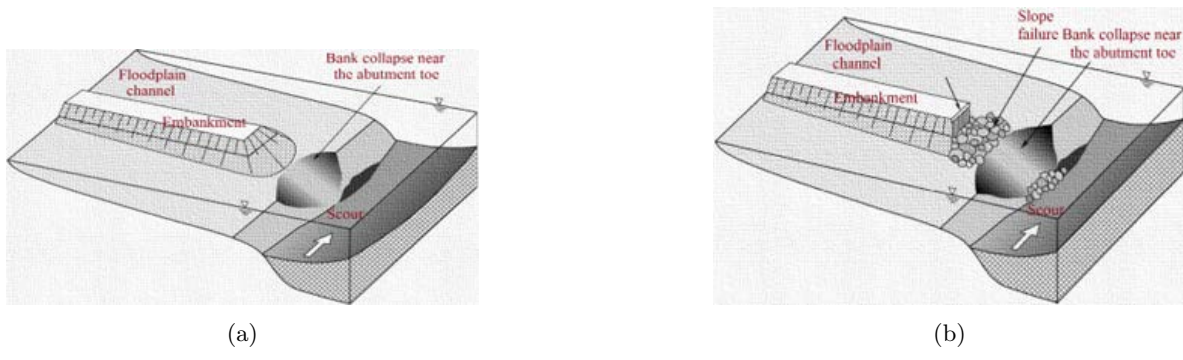

Figure 4: Multi-stage collapse process of a spill-through abutment in a compound channel due to scour associated with scour condition I: (a) Hydraulic scour of the main channel bed sediment leading to riverbank instability and failure; (b) failure of the abutment embankment face. Under this condition, the floodplain is much less erodible than the main-channel sediments [adapted from NCHRP].

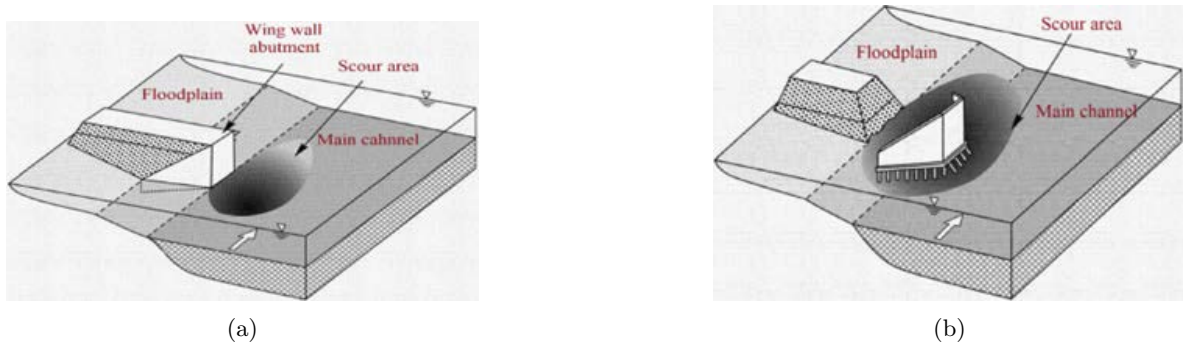

Figure 5: The two-step scour-induced collapse process of a wing-wall abutment associated with scour condition I: (a) Hydraulic scour of the main-channel bed sediment which leads to riverbank instability and failure; (b) Failure of the channel bank and the approach embankment face [adapted from NCHRP].

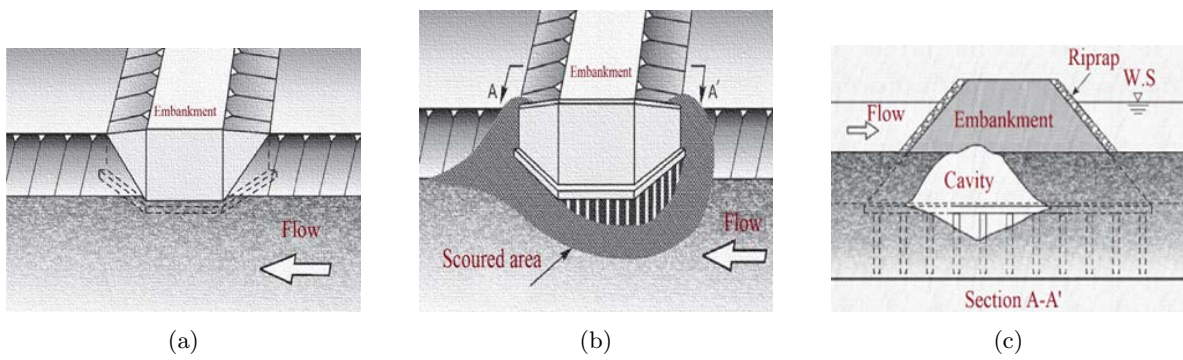

Figure 6: Collapse process of a wing-wall abutment due to the erosion of embankment soil beneath the abutment pile cap: (a) before scour; (b) scour develops under the pile cap; (c) embankment soil is sucked from the beneath of the pile cap forming a cavity in the embankment [adapted from NCHRP].

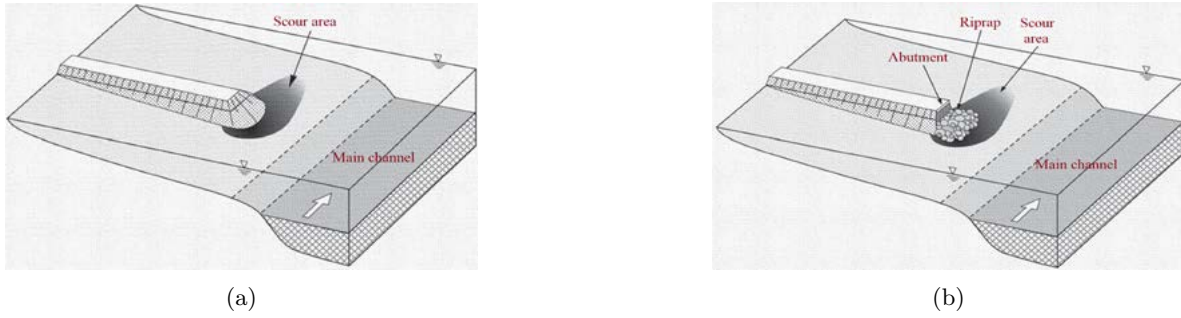

Figure 7: The scour-induced collapse process of a spill-through abutment in a compound channel associated with scour condition II: (a) hydraulic scour of the floodplain; (b) failure of the approach embankment face. Under this condition, the floodplain is more or less erodible. Also, the collapse of the embankment soil and armor layer into the scour hole modifies the scour area [adapted from NCHRP].

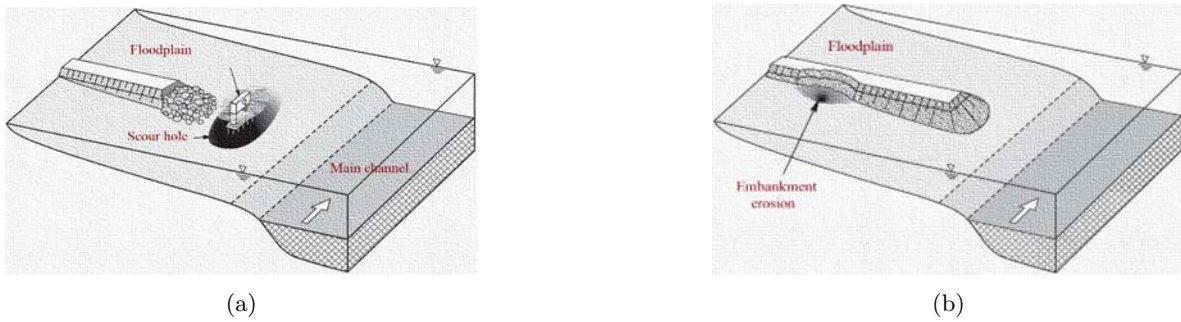

Figure 8: (a) Full washout of the approach embankment exposes the abutment foundation, which can result in the abutment structure's scour process as if the abutment were a form of a pier; (b) Impingement against a long approach embankment resulting in erosion of the embankment [adapted from NCHRP].

Condition III: Scour under conditions I and II may eventually lead to the approach embankment washout, thereby fully exposing the abutment. In this case, scour at the exposed stub or wing-wall abutment can be treated as the scour of piers, as shown in Figure 8a.

Condition IV: Scour at the embankment approach some distance from an abutment. In this case, the embankment intercepts and deflects the flow on the floodplain. Still, the unprotected portions of the floodplain near the embankment might be exposed to eroding velocities resulting in a local slide slope failure of the embankment. It should be noted that this scour mechanism under this condition is different from those described for conditions II and III, as such it does not occur at the bridge opening. Also, under somewhat extreme cases, the erosion and washout of the barriers are also possible under this scour condition.

Condition V: Scour as the result of overtopping of the approach embankment with high flow. The leading causes of overtopping at a bridge opening are the low crest elevation of the approach embankment and clogging of the bridge opening with vegetation debris and, in some cases, with ice (during the early spring season). When overtopping occurs, flow spilling over the abutment can erode the floodplain along the abutment's downstream side. As a result, the embankment side slope might experience a local slope failure. This slope failure is similar to dam-breaching, and to some extent, the scour that develops immediately downstream of an unprotected outlet of a culvert. It is noted that an abutment scour occurrence (or a series of sequential scour events) might consist of a sequence of all five scour conditions described. As some general rules, when the abutment is close to the stream main channel, condition I might develop relatively quickly while condition II progresses at a slower rate. It should also be noted that scour conditions I and II can either separately or jointly lead to the approach embankment's slope-stability failure. Suppose the embankment washes out to the degree that the abutment structure becomes exposed. In that case, the abutment structure's scouring is also

possible akin to the scouring process of piers (see Figure 8). All the described scour conditions are likely for both pile-supported or spread-footing-supported abutments and are of practical importance for the design, construction, and monitoring of abutment scour countermeasure.

T1.4 Abutment scour countermeasures

Over decades, a wide variety of approaches have been proposed to mitigate scour's destructive actions at abutments. In a broad view, two categories of scour mitigation approaches have been proposed: (1) Flow altering approaches and (2) Bank-hardening (also called bank armoring) approaches [5]. As the name implies, the basic intent of flow-altering approaches is a local modification of the flow field at an abutment to diminish its scouring capacity. This modification is generally achieved by attaching a form of a vane, plate, collar, delta wing, and other forms of flow-control structures to the abutment. The placement of such structures contributes to the flow-field modifications by constraining the flow to remain its predetermined channel with its minimum eroding capabilities, limiting bed erosion to impede the upstream progress of channel degradation, or directing flow into the bridge waterway to enhance the flow alignment and thereby minimize flow turbulence and scour at the waterway. One example is submerged vanes as shown in Figure 9. Submerged vanes are small plate structures alternative to spur dikes, bendway weirs, or barbs. Submerged vanes are installed in the main channel to improve the approach channel alignment. The vanes can separate the abutment's flowlines to minimize the flow velocity and imposed shear stresses while increasing the velocity at the middle of the channel. Fathi and Zomorodian [10] conducted some experimental laboratory studies to identify the factors affecting the performance of submerged vanes under the vertical wall and spill through abutments and concluded that the number and directions of the vane, as well as the location of the first vane, can decrease the maximum scour at the abutment up to 30%. The results showed that changing the numbers or directions of vanes or the first vane location could effectively decrease the maximum scour by around 30%.

Alternatively, bank hardening methods are those dealing with armoring of flow boundaries susceptible to erosion. If adequately implemented, armoring can substantially increase the capacity of a boundary to resist erosion. Armoring methods are by far the most common form of scour countermeasure for abutments, such as: riprap, concrete armor units (CPUs), articulating concrete block (ACB) system, gabion mattresses, grout-filled mattresses. In provisioning for appropriate abutment scour countermeasures, the following five criteria should be considered: technical effectiveness, constructability, durability and maintainability, aesthetics and environmental issue, cost. Moreover, selecting abutment scour countermeasures also need to base on scour concerns. For example, the methods like low weirs and sheet pile around the abutment could be used for countermeasures to deal with mitigation of channel bed degradation, and flow control countermeasures and bank protection strategies can be classified to use for approach-channel control.

The most investigated abutment scour countermeasure category is the approach-channel category. Extensive publications exist for the design, construction, and maintenance of the structures belonging to this countermeasure category. For example, [17, 18, 19, 24, 25, 28, 31, 33, 35, 37] presented some design recommendations for flow-control structures and bank protection. Lagasse et al. [21] and Richardson et al. [34] discussed some design guidelines for impermeable and permeable spur dikes, guide banks, and riprap stability factor design.

T1.5 Summary of literature review

A comprehensive review of the up-to-date work on bridge abutment scour is presented in this task. The state-of-the-art of bridge abutment scour and its history are introduced. Possible parameters affecting scour depth are reviewed. Abutment scour types and processes and failure mechanism are collected. Various scour countermeasures applied in practice are also summarized. Bridge abutment scour is a common but complicated 3D problem. A significant number of researchers have contributed to the field, with multiple studies addressing many different conditions. The mechanism of scour failure is diverse due to these varying conditions, and a more detailed understanding is still needed. Selecting scour countermeasures should thus be based on a series of factors, including cost considerations of possible failures in the future, rather than absolute prevention of scour.

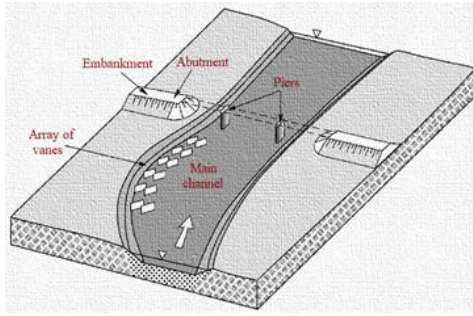

(a)



(b)

Figure 9: (a) Schematic of submerged vanes used to stop lateral migration of an approach channel and to narrow the approach channel to match the width of the bridge opening [adapted from NCHRP]; (b) An example of submerged vanes [retrieved from Fitzpatrick et al. [11].

T2 Identification and documentation of Wisconsin bridges with heavy riprap slope failure issues

Task 2 focuses on identifying and documenting bridges in Wisconsin with heavy riprap slope failure issues and collecting information required for gauging such issues in terms of cause and severity through some comprehensive surveys from WisDOT and other state transportation agencies. Moreover, this task lays the groundwork for LCCA in Task 6 by gathering such information as slope and structure repair costs and the number of repairs in given service life for existing and alternative slope protection approaches.

T2.1 Identification of bridges with critical conditions

The research team initially reached out to regional engineers to identify problem bridges within the state. From these discussions, the team received a list of 41 problematic bridges, primarily located in Wisconsin SW (encompasses most of the driftless area – steep slopes, heavily forested in the northern section, flashy streams), as well as 14 relatively new bridges (2009-2011) along the USH 10 corridor in Portage & Wood County experiencing sliding of the protection layer up to 16 inches.

The list of originally identified bridges is found in Table A.1. It was clear from discussion with WisDOT engineers that the most critical bridges were grouped geographically, as mentioned above. Figure 10 presents a map identifying these trends.

It was noted that while specific failures in the SW region appeared primarily after high rainfall (>100 year events), it was in contrast to a trend statewide towards slow methodical creeping of the abutment slope. As discussed in Section 12, this tracks with the broader conclusions of the research team, concerning general slope instability overall, as opposed to bridge-specific scour.

From the initial list of bridges identified as being of concern, a shortlist of 18 bridges was taken to represent the primary areas of concern (northcentral and southwest). The researchers outlined the details for each of the bridges, such as river hydraulics and prior maintenance. The team also reviewed how much supplemental information was available for the bridge, such as inclinometer measurements or photos from past inspections. The goal was to select bridges which both covered a range of conditions and provided sufficient information to identify the cause of failure. The final list of bridges is provided in Table 1.

Table 1: Bridges selected for site visits

Name	Bridge Design	Span Type	Span Length (ft)	Road
B-12-076	Flat Slab	Cont. Concrete	34	USH 61
B-12-102	Deck Girder	Prestressed Concrete	100	STH 60
B-35-062	Deck Girder	Prestressed Concrete	120	USH 51 NB
B-35-063	Deck Girder	Prestressed Concrete	120	USH 51 SB
B-43-018	Deck Girder	Prestressed Concrete	88	USH 51
B-52-114	Flat Slab	Cont. Concrete	26	STH 80
B-58-075	Deck Girder	Prestressed Concrete	133	STH 29 W
B-62-017	Deck Girder	Prestressed Concrete	47	USH 61-STH 131

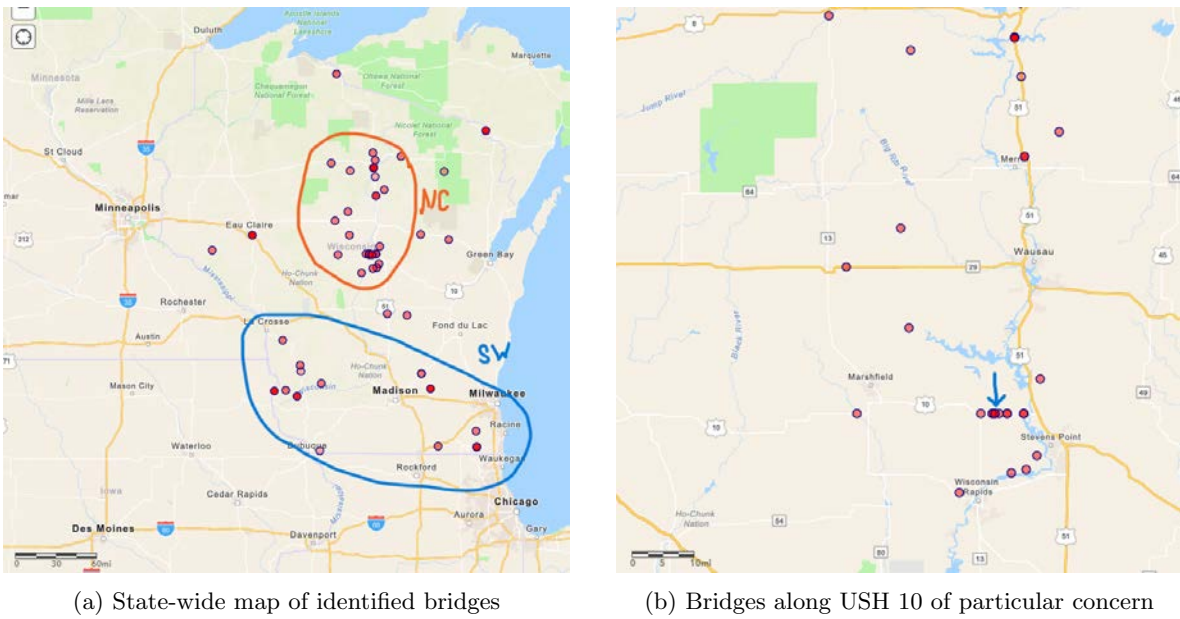
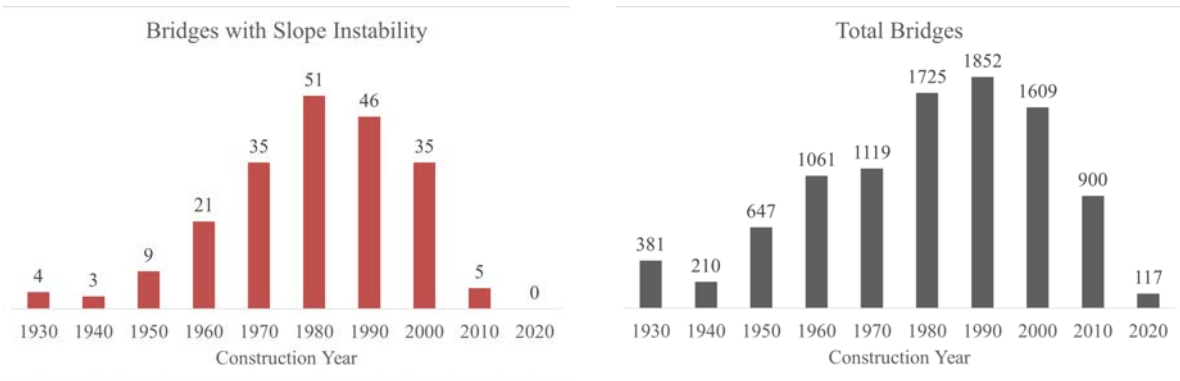

Figure 10



(a) Bridges identified as exhibiting slope instability

(b) All over-water bridges in Wisconsin by construction year

Figure 11

T2.2 Estimation of total percentage of undermined over-water bridges

According to the Wisconsin Highway Structures Information System (HSI), there are currently 1,265 bridges which are classified as needed slope protection repairs or exhibiting abutment undermining, out of roughly $B_{tot} = 9600$ total over-water bridges in the state.

It was found that an estimated 200 over-water bridges (or 16% of the 1,265 identified) do not experience river scour or localized movement. These 200 bridges are then categorized as having unstable abutment soil conditions. Thus, compared to all 9,600 over-water bridges, $X_{tot}=2.2\%$ exhibit abutment undermining due to soil instability. Figure 11 outlines trends by decade of construction. It can be concluded that the observed failures are not limited to historical construction, and indeed overall follow a similar trend based on total construction.

As bridges are designed with a lifespan of 50-75 years, it is relevant to look only at bridges less than 30 years from construction, as that is an expected time for major maintenance. Considering only bridges built after 1990, 86 bridges are exhibiting notable undermining, out of $B_{rec} = 4,500$ built, or $X_{rec}=1.9\%$, which is similar to the overall trend.

Table 2: Table 5.4-23 Stream Crossing Structures (WisDOT 2020)

Structure Type	No. of Bridges	Total Area [sq. ft.]	Total Costs	Super. Only Cost [per sq. ft.]	Cost [per sq. ft.]
PS Concrete Girders	28	236,564	35,597,272	70.46	150.48
RC Slabs (Flat)	35	57,402	10,783,692	72.40	187.86
RC Slabs (Haunched)	7	53,236	6,866,154	65.48	128.98
PS Box Girder	2	9,050	2,694,672	157.15	297.75
Steel Plate Girders	1	19,076	5,258,732	120.51	275.67

Table 3: Unit price estimates

Item	Unit Cost
Excavation (common)	\$17 /yd ³
Backfill (borrow)	\$20 /yd ³
Geofabric	\$7.5 /yd ²
Riprap	\$50 /yd ³
Superstructure	\$70 /ft ²

T2.3 Collection of unit costs for use in life-cycle cost assessments

In preparation for Task 6, information concerning bridge costs in Wisconsin is gathered. Table 2 shows units costs based on 2020 over-water bridge construction. From this, a weighted average of the three noted structure types are considered. The resulting value is estimate at \$70 per square foot of superstructure. Although substructure costs may be influenced by lengthening of the superstructure, they are not considered for this analysis. It is presumed that the majority of bridges would not need costly design remedies such as deeper girders or expansion joints. This is the conservative assumption. Similarly, as mentioned, only the superstructure cost is considered from Table 5.4-23 (Table 2), although this is not typical of WisDOT cost comparisons. This is done for simplicity of analysis, and again as a conservative assumption. Additional WisDOT documents as well as communication with WisDOT engineers led to estimations per material for abutment construction, as seen in Table 3.

T3 Surveillance of current abutment slope protection practices in upper Midwest states

A survey of the nearby states of Illinois, Indiana, Iowa, Michigan, and Minnesota was undertaken, with the goal of identifying the use of slope failure countermeasures and respective degree of success. A copy of the survey and full results are provided in Appendix ??.

T3.1 Survey questions

The survey was designed to identify trends in scour of bridge abutments in surrounding regions, as well as characterize the design guidelines and countermeasures utilized by state engineers. The following topics were surveyed:

- Observed geographic trends and regional differences with respect to scour concerns
- Typical abutment slopes and scour protection design guidelines
- Typical countermeasure failure statistics, maintenance, and historical changes in strategies
- Overall positive and negative effects of typical abutment design and countermeasure

T3.2 Key survey results

Of the five states, only Michigan indicated scour as a critical problem for the agency, estimated to be a concern for about 1600 bridges, 17% of all over-water bridges. Indiana noted 530 scour-critical structures out of 17,000 over-water bridges, while Illinois, Minnesota, and Iowa all noted less than 300 scour critical bridges per state. These are compared to the roughly 1200 identified in Wisconsin under Task 2 (Section T2). Michigan DOT noted that the majority of their scour critical bridges are found on bridges with spread footings in erodible soil - a historically common practice due to local soil over-consolidation from glaciers. Illinois did identify some regional variation in scour, and Iowa stated Loess soils in the Western region effected their bridges to some extent; Minnesota and Indiana did not note any regional difference in scour. From this, researchers concluded that the majority of surrounding states do not have an issue with over-water bridge abutment scour or slope concerns, and while Michigan does have some concern, the root cause is due to historical footing design rather than river hydraulics or abutment design. All states did refer to HEC-23 for scour protection guidelines.

All five states indicated the typical abutment slope was designed as 2:1 (H:V) or flatter, the most notable difference compared with Wisconsin, which typically calls for a 1.5:1 (H:V) slope in over-water bridges. This appears to be a critical difference, and the associated cost is explored more fully in Task 6 (Section T6). All states replied that riprap is their primary method of slope protection, supplemented by grouted riprap where appropriate, and additional measures occasionally used; geotextiles are also used in most cases. However, both Michigan and Minnesota noted that fully paved/grouted slopes were generally unsuccessful countermeasures.

Most states used biennial inspections with additional considerations after the first major flooding per bridge. Excepting Michigan, all states have had no major changes to their approach in recent decades. Michigan specified they have been attempting more designed countermeasures recently to reduce scour critical inventory. Overall, all surveyed DOTs felt their countermeasures were generally successful in reducing or eliminating scour.

Summarizing survey results, it was concluded that scour is generally not of concern to the states surrounding Wisconsin. For those sites where there was a concern, the relevant DOTs found that riprap provided sufficient protection according to their needs. Furthermore, all surveyed states design with a slope of at most 2:1. These results agree with our findings in Task 4 (Section T4), which indicates that it is not hydraulic scour which causes the observed slope failures in Wisconsin, but rather general slope instability due to steep abutments.

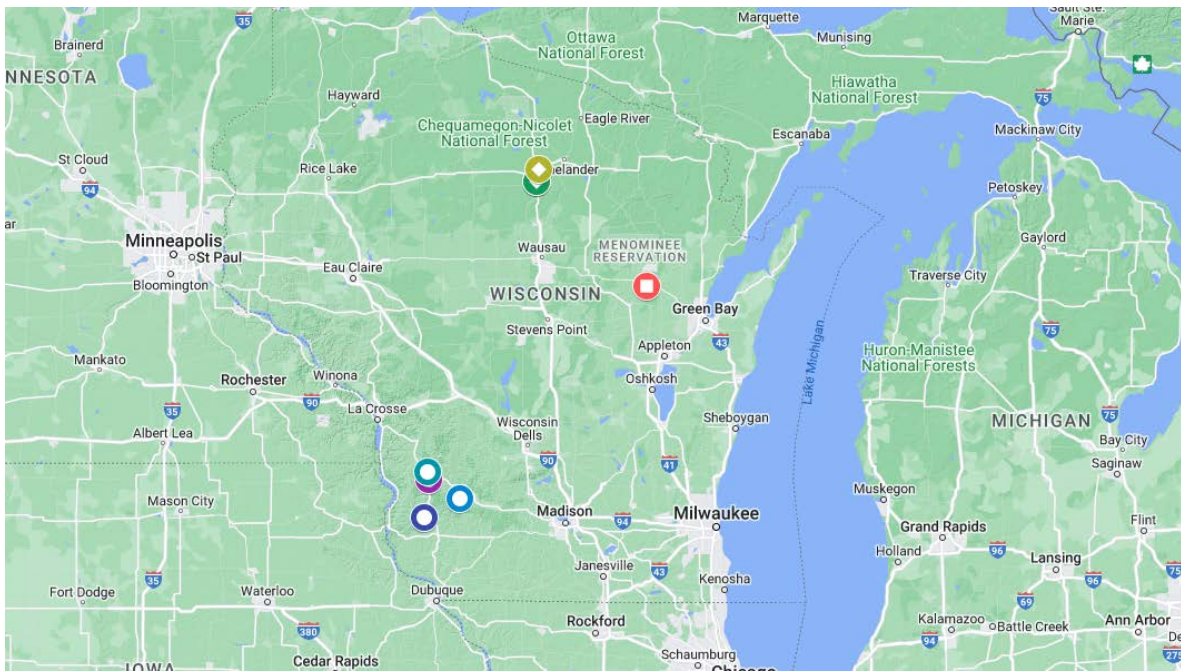

Figure 12: Bridges selected for site visit

T4 Site visits and qualitative field review of bridges with heavy riprap slope failures

As discussed in Section T2, a group of eight (8) bridges were chosen for site inspection. The bridges selected included both SW and NC locations, and expressed a variety in slope failure modes, as interpreted by information available through the HSI. Locations are shown in Figure 12. Site visits were led by Ciorba Group, consulting engineers for the project. The full inspection report is provided in the Appendix.

T4.1 Summary of observations

Although the riprap specified type is the same for all structures (heavy riprap), the actual riprap size differs between the bridges. All bridges did not have a flat area against the abutment and the riprap is placed at an angle against the abutment.

As per WisDOT maintenance engineers present in the field during the inspection, most of the ripraps evaluated are designed to be on a 1.5:1 slope (H:V) and bottom of riprap is designed to be 2'-6" minimum from bottom of abutment concrete.

It is noted that upon identifying erosion issues at abutments, concrete slurry has been the most common repair performed. The concrete pours are introduced at the gaps between the eroded riprap and the abutment especially when there is undermining observed at the abutments. However, the pours are not anchored into the abutments and thus would simply erode with the continuously eroding riprap at the abutments.

The wingwalls were observed to have steep slopes in front, and minimal proper drainage is observed for stormwater flowing from top of roadway along the side the wingwalls. Drainage treatments for stormwater runoff flowing outside the bridge / roadway limits is not consistent between all bridges evaluated in this inspection. Open guardrail with no curb or flumes, concrete curbs with gutters, HMA flumes, and concrete flumes are used at different bridges. Flumes are typically added outside the parapet limits to help guide water from the top of the roadway away from the abutments. Not only are the flumes different in materials used, but the constructed flumes of same material also have different depths, openings, and redirections between the bridges.

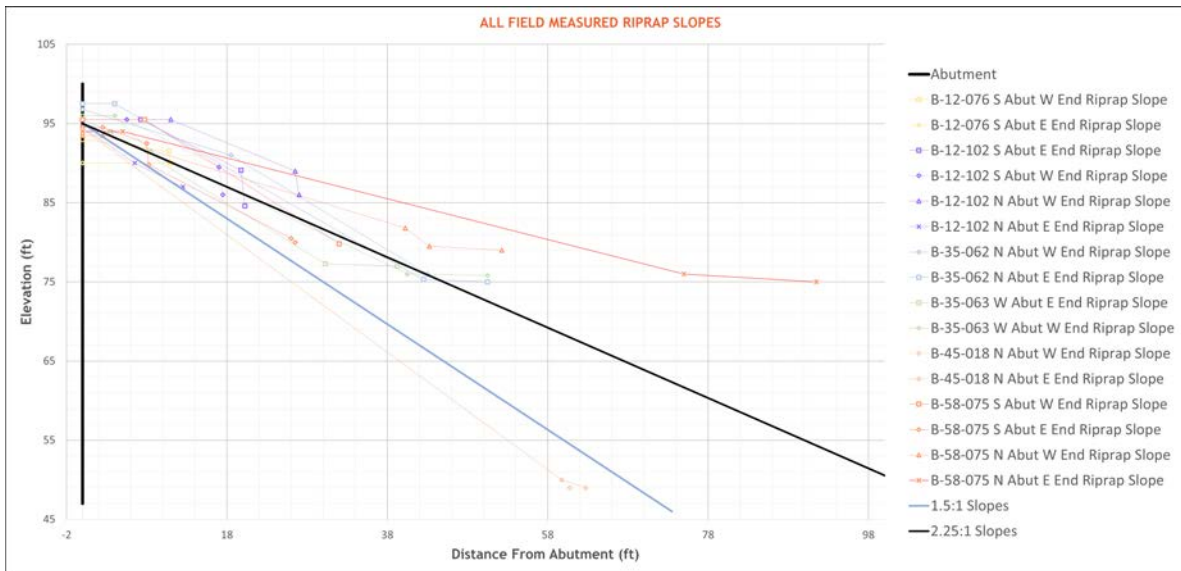

Figure 13: Observed slopes compared to a design slope of 1.5:1 (H:V), and a mean slope of 2.25:1.

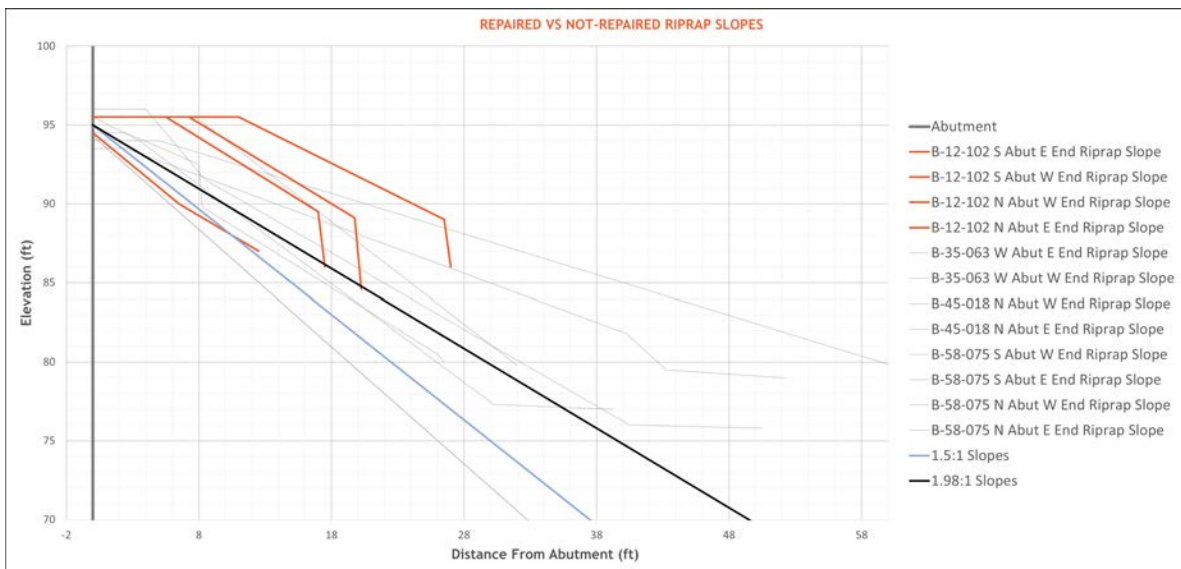

Figure 14: Observed slopes compared to a design slope of 1.5:1 (H:V), and an average current slope of 1.98:1 (not including grouted abutments, or bridges exhibiting purely scour failures). Orange slopes indicated abutments without any repair attempts.



Figure 15: B-52-114 a) South abutment, overall view, b) Zoomed in photo of wide crack in closure pour, c) North abutment concrete pour repair noted with a gap between the abutment and pour repair indicating movement of repair. Abutment stem (typical for both abutments) is 8 degrees out of plumb inwards towards the pier, d) Upstream at center pier. Blue arrows indicate water flow.

T4.2 Discussion of bridge conditions

B-52-114 (built 1990)

The two-span, slab bridge superstructure is sitting on a wall type pier on piles and integral or semi-integral abutments on piles and heavy riprap (Figure 15a). Localized scour was observed at the pier. This was hypothesized to occur in part due to the channel divergence (Figure 15d). The riprap at both abutments is eroding, originating at the top of the abutment, Figure 15c. A concrete pour along the top of the slope was performed in 2019 to protect the base of the abutment. Wide cracks were observed in the poured concrete (see Figure 15b). Cracks in riprap at the base of the slope were also observed.

B-12-102 (built 2001)

The single span bridge is made of a concrete deck with prestressed precast concrete (PPC) I-Beams and only integral / semi-integral abutments on piles with heavy riprap (Figure 16a). Localized erosion is noted at the west end of the south abutment; see Figure 17a. The noted erosion is exposing the substructure piles; see Figure 17b. The south abutment is also notably exposed throughout the length of the abutment (Figure 16b). The wingwalls are typically noted with steep riprap slopes. Roadway erosion was noted at top of wingwall at the parapet ends. Finally, the river channel has diverged behind the west abutment. No riprap repair was noted at this bridge.

B-12-076 (built 2011)

The two-span, PPC deck beams bridge superstructure is sitting on integral / semi-integral abutments on piles with a pier cap on steel H columns. The pier has been retrofitted at the center columns



(a)



(b)

Figure 16: B-12-102 a) South abutment, overall, b) Erosion along the south abutment



(a)



(b)

Figure 17: B-12-102 a) Southwest corner noted with localized erosion b) Exposed pile, at location indicated in Figure 17a



(a)



(b)

Figure 18: B-12-076 a) Middle pier with retrofit, b) Water marks near the east abutment indicating the flow has diverged away from the east abutment



(a)



(b)

Figure 19: B-12-076 a) Looking downstream, b) Riprap scoured at north end of west abutment

(Figure 18a). The west abutment heavy riprap is eroding at the north end of the abutment due to the change in the channel, see Figures 19a and 19b. The east abutment was noted with sediments indicating that the normal flow within the channel has shifted away from the abutment (Figure 18b). The existing piles from the previous structure were left in place and the filter fabric was caught by the existing piles and is causing the fabric to be torn; see Figure 20a. Finally, heavy cracks were observed in the riprap at the water level; see Figure 20b.

B-62-017 (built 1967)

The three-span concrete deck with PPC I-Beam superstructure bridge is held by integral/semi-integral abutments on piles with heavy riprap and a pier cap with circular concrete columns as shown in Figure 21a. The riprap at the south abutment, east end close to the north pier, was noted with heavy erosion. Heavy erosion was also observed at the west end of the abutment, initiating from the abutment, exposing the abutment piles; see Figure 22. The north abutment has a concrete pour correction (performed in 2014) which is eroding with the riprap and noted with heavy cracks; see Figure 21b. Finally, there are HMA flumes at the parapet ends typical for each corner.

B-35-063 (built 1983)

The multi-span PPC I-Beam with concrete deck bridge is supported by integral/semi-integral abutments on piles with heavy riprap and hammerhead piers (Figure 23a). Only the north abutment was investigated for this bridge since the south abutment is over roadway. This bridge is parallel to B-35-062 bridge (Figure 25) and has riprap connecting both bridges at the north abutment; see B-35-062 for photos and condition. The bridge has a concrete curb and gutter extending from the



(a)



(b)

Figure 20: B-12-076 a) Filter fabric is caught by the existing piles and tearing/damaging the fabric, b) Typical fractures noted in the riprap rocks



(a)



(b)

Figure 21: B-62-017 a) North abutment and north pier overall b) Corrective concrete slurry at north abutment



(a)



(b)



(c)



(d)

Figure 22: B-62-017 Photos showing abutment under-mining at the southwest end.



Figure 23: B-35-063 a) North abutment overall, b) Riprap repair near east end of north abutment

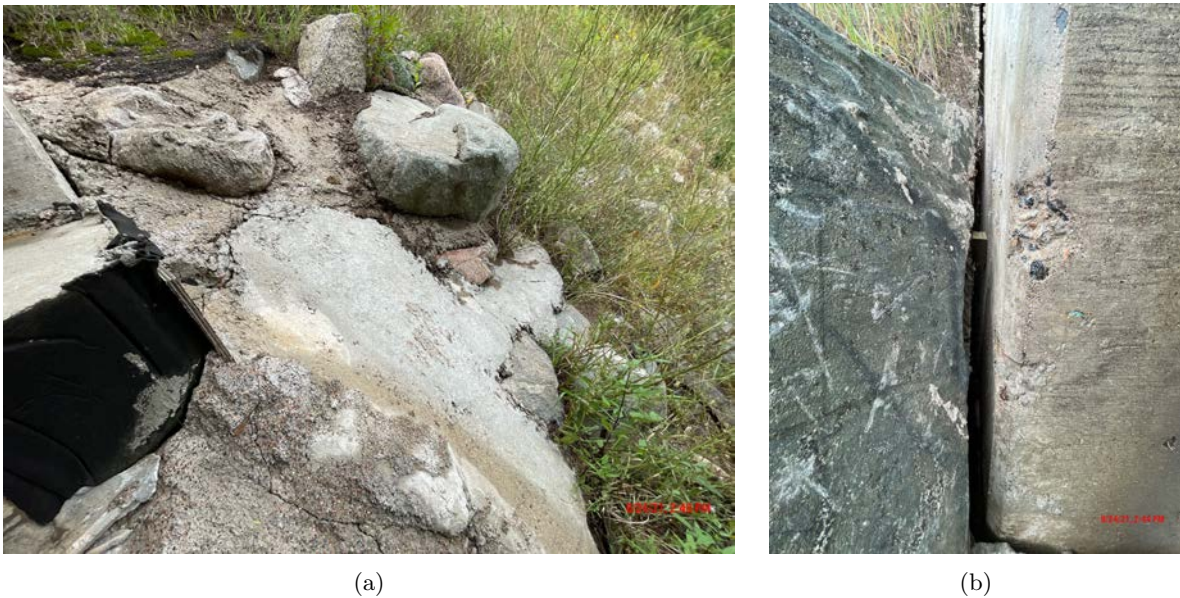

Figure 24: B-35-063 a) Steep change in slope at northeast wingwall, b) Gap between abutment and side riprap along wingwall

parapet ends at northwest and northeast locations. The east corner of the north abutment was noted with heavy erosion with concrete blocks used as repairs in 2017 (Figure 23b). A steep change in slope was observed at the northeast wingwall seemingly from the concrete repair applied at that location; see Figure 24a. The riprap at the east end of the north abutment was noted with watermarks along the riprap. The northwest wingwall has a gap between the wingwall concrete and the riprap (Figure 24b).

B-35-062 (built 2000)

The multi-span PPC I-Beam with concrete deck bridge is supported by integral/semi-integral abutments on piles with heavy riprap and hammerhead piers. The bridge is parallel to B-35-063 bridge (Figure 25) and has riprap connecting both bridges at the north abutment. The east end of the north abutment was noted with a gap between the riprap and the abutment; see Figure 26a. Per WisDOT field engineers, a concrete pour over repair was done in 2015 on the eroded riprap to cover any erosion/scour holes created by the riprap erosion; see Figure 27 for riprap existing condition overall. A severe hole near the west half of the north abutment was noted. The hole can fit a full-sized person and extends in both directions, towards the abutment (exposing abutment piles) and away from the abutment; see Figure 28. Additionally, the riprap, close to the abutment, was noted with typical cracks



Figure 25: B-35-62 and B-35-63



(a)



(b)

Figure 26: B-35-062 a) Gap between bridge and riprap at east end of north abutment, b) West end of north abutment

and sounded hollow indicating the concrete repair is not supported by soil underneath (Figure 26b).

B-43-018 (built 1992)

The three-span PPC I-Beam with concrete deck bridge is supported by integral / semi-integral abutments on piles with heavy riprap and hammerhead piers; see Figure 29a. The riprap on this bridge is being surveyed to evaluate the riprap movement and an inclinometer is being used to assess the soil erosion, Figure 30. The left in place guardrail used for concrete pour has started to erode with the existing riprap; see Figure 29b. Erosion along the riprap layout was noted at the west of the north abutment riprap. There is a localized scour under the northwest wingwall with an exposed active pipe emitting water under the abutment at the scour location; Figure 31. The guardrail post at the northeast wingwall is out of plumb due to the water passing around the wingwall.

B-58-075 (built 1996)

The multi-span PPC I-Beam with concrete deck bridge is supported by integral / semi-integral abutments on piles with heavy riprap and hammerhead piers; as shown in Figure 32a. The riprap on this bridge is being surveyed to evaluate the riprap movement and an inclinometer is being used to assess the soil erosion; see Figure 33. The wingwalls were noted with steep slopes as a typical condition. The concrete pour at the west abutment, north end, had sheared off. Concrete repairs in 2014, 2019, and 2020 have left sandbag attachments in place attached to the repair; thus, adding dead weight to the repair after the soil underneath has eroded (see Figure 34). The erosion at the south



(a)



(b)

Figure 27: B-35-062 a) Riprap near west half of north abutment, b) Hole noted near west half of abutment



(a)



(b)

Figure 28: B-35-062 a) Riprap existing condition at north abutment, b) Riprap at north abutment from bottom of riprap



(a)



(b)

Figure 29: B-43-018 a) Looking south from bridge, b) Gap at north abutment of riprap



(a)

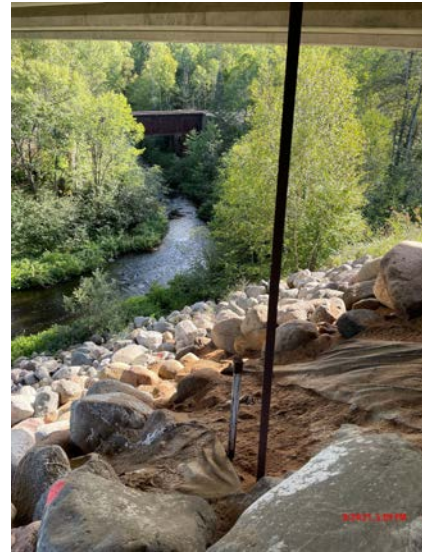

(b)

Figure 30: B-43-018 a) Scour near center half of north abutment. Red dots on riprap indicates riprap elements surveyed, b) Inclinometer device



(a)



(b)

Figure 31: B-43-018 a) Scour under the west wingwall, b) Drain relative location compared to wingwall and abutment

end of the west abutment was noted with an exposed pile; Figure 32b.



(a)



(b)

Figure 32: B-58-075 a) Looking east along the bridge, b) Exposed piles under the abutment due to noted scour/erosion



(a)



(b)

Figure 33: B-58-075 Movement monitoring



Figure 34: B-58-075 a) Concrete slurry repair with sand bags left in place attached to the repair and adding dead weight due to soil erosion under repair, b) Scour under the abutment

T5 Assessment of the extent and causes of identified concerns in preceding tasks

T5.1 Assessment methods

The goal of Task 5 is to simulate the bridge conditions typically found, investigating the causes of failure, such as abutment geometry and river flow. Although hydraulic analysis was originally planned, the results from the site visits (Section T4) led the research team to identified slope stability analysis as the primary failure mode of bridges with critical abutment undermining. Thus, the computational methods utilized for this task shifted. Potential software packages such as PLAXIS and Slide2 were discussed to determine which package provides relevant features for the planned analysis, as well as influencing factors such as geotechnical conditions and hydraulic assumptions. After consideration of licensing fees and required capabilities, Slide2 was chosen. The primary quantitative measure of failure for these analyses will be the calculated factor of safety (FS). An FS of less than 1.3 is defined as failure; this is below the minimum design requirements. An FS above 1.5 is considered adequate, and above 1.7 is classified here as exceeding requirements. Every simulation is run using multiple calculation methods (Bishop, Janbu, Spencer, and Morgenstern-Price), however all FS discussed below will be calculated using the Spencer model for simplicity.

T5.2 Verifying modelling approach using inclinometer data

Two critical bridges visited during Task 4 had inclinometers installed in 2019; B-58-75 and B-43-18. The inclinometer data of both bridges is provided in Section A2. It can be seen that the failure surface originates roughly 8-10 feet below grade. Thus the first objective of Task 5 was to replicate this failure mode. Of the two bridges, B-58-75 exhibited more extreme soil movement, and thus was chosen to validate the outlined assessment approach.

A simplified model of the abutment is shown in Figure 35, with a designed slope of 1.5:1 (H:V), along with initial approximations of the soil properties (cohesion and friction angle). The granular backfill on the foreslope was called out as Grade 1 on the bridge plans (either sand-sized particles or sand-sized particles mixed with gravel, crushed gravel, or crushed stone). Additional discussion with WisDOT geotechnical engineers also assisted in informing the choice of soil parameters, with the understanding that in-situ properties are rarely tested. As seen in Figure 35, the abutment was modeled with three layers, indicated as riprap, backfill, and local silty soil. Results for these parameters are shown in Figure 36a, where $FS = 1.252$. A geosynthetic layer was then applied between the riprap and backfill material, which was used in B-58-75. These simulation conditions are then defined as the as-built dry case, shown in Figure 36b. It can be seen that although the geotextile fabric did add some stability ($FS = 1.277$), it might be considered negligible. Regardless of geotextile, the FS is below the allowable consideration for design in dry conditions, which is generally the less conservative case.

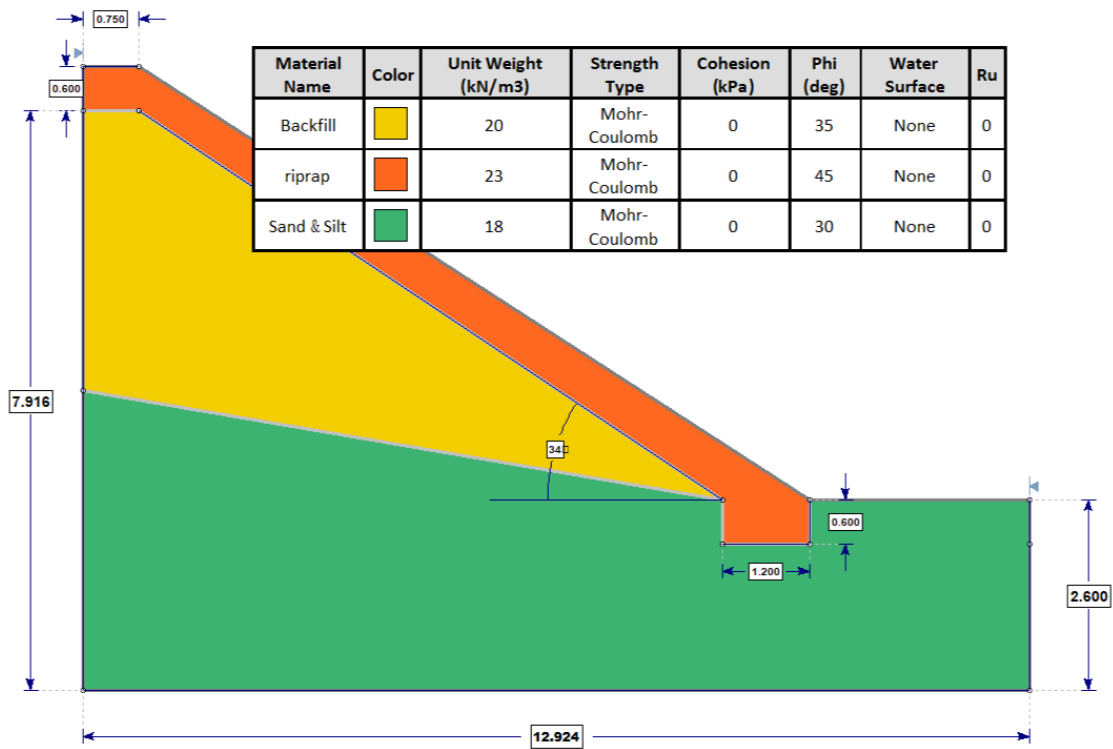

Figure 35: Simulation geometry and initial soil properties for B-58-75

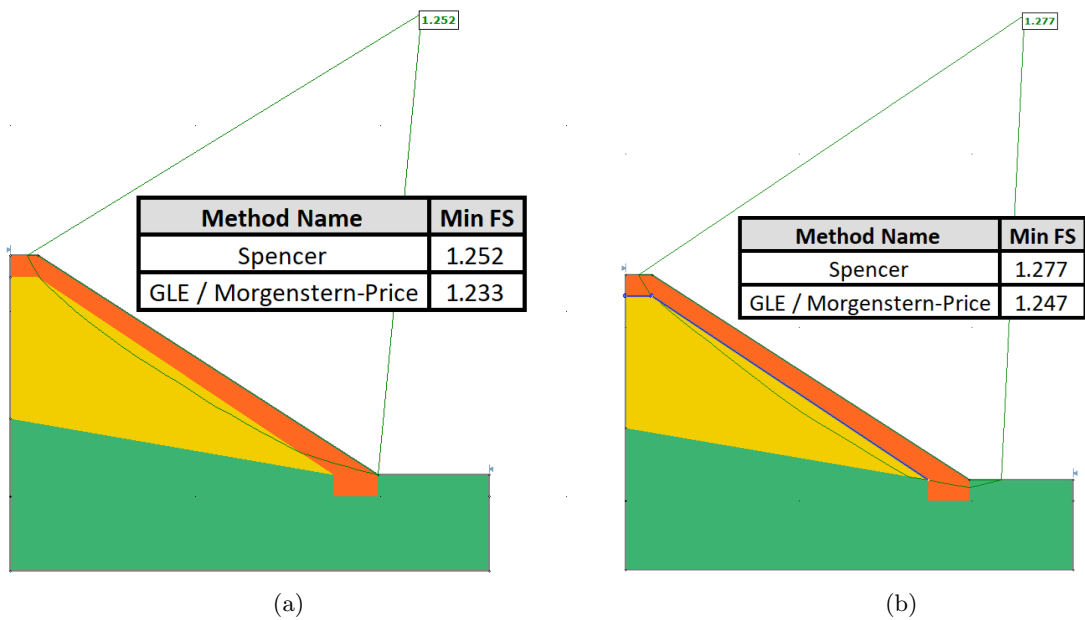

Figure 36: Benchmark analysis of B-58-75 for simulation validation. a) result of analysis of B-58-75 without geotextile fabric, b) simulated as-built dry conditions

Following the dry case, a series of simulations was run with varying water table elevations to replicate low and high river levels. Analysis with the water level at base of slope, 3 ft above base, and 5 ft above base were considered as common scenarios for low, average, and high water levels. Figure 37 shows the results. The maximum associated failure surfaces are 6 ft (FS = 1.177), 5 ft (FS = 1.175), and 8 ft (FS = 1.140) below riprap, respectively. When compared to the inclinometer data (Figure 33b), which indicate a failure depth of 8-10 ft, it can be seen that the simulations provide good agreement with measured data. Though the analysis underestimates failure depth, it also is conservative with respect to water levels and soil parameters. Thus the results are sufficient to validate the modeling approach. It can also be seen in Figure 37c that the failure surface is deeper than the riprap toe, indicating that a deeper toe may help to improve conditions in high water level events.

T5.3 Investigation of failure mitigation and protections measures

Using the same bridge model and methods, potential design improvements are investigated. The following analysis are performed on dry soil to remove the variable of river height, but it should be noted this underestimates instability with respect to actual conditions.

First, a slope of 2:1 is analyzed. As noted in Task 3 (Section T3), surrounding states primarily design over-water bridges with 2:1 or flatter slopes, in comparison to the SOP design of 1.5:1 (H:V) in Wisconsin. These states by-and-large do not experience similar abutment undermining; in combination with the observations in Task 4 (Section T4), this indicates that a flatter slope should result in improved slope stability. Indeed, when a slope of 2:1 is simulated, the resulting FS is 1.52 (Figure 38a), compared to 1.277 of the as-built dry case. This strongly indicates that a shallower slope would reduce the occurrence of abutment undermining of over-water bridges. The cost ramifications of such a slope are explored further in Task 6 (Section T6).

In addition to variation in designed slope, it is also relevant to consider various repair methods previously considered by WisDOT. For instance, grouting of the riprap is a common tool to improve scour resistance, but has occasionally been used by WisDOT in cases of abutment undermining where the cause is in fact slope stability, and not scour. In these conditions, additional weight due the grouted riprap is likely to exacerbate the condition, rather than reduce movement. This is seen clearing in bridge B-35-62 (outlined in Section T4), where although grouting prevented additional sliding of the riprap, the soil beneath continued to move, resulting in a large gap between the riprap and abutment (Figure 27). However, upon simulating such a condition, the analysis resulted in an FS of 3.0, indicating it should be a suitable method for protection (Figure 38b). This is likely due to the limitations of the utilized simulation method, which constrains the interface between cover and soil such that movement of the slope independent of the riprap is restricted. In the field such an fully bonded interface is highly unlikely to occur, and thus a FS of 3 is unlikely to be fully realized.

A similar repair method of protecting exposed abutment piles with flowable concrete also results in additional weight upon the slope, increasing instability. Figure 39a shows an increase FS compared to the as-built dry case ($1.229 < 1.277$), indicating that this is not preferred, however it is a small enough reduction that the use of such a repair as protection of undermined abutments is not a critical factor in continued slope movement. It is also seen that extension of the riprap toe (Figure 39b) does not significantly improve the stability of the slope, nor does an alternate toe shape utilized by Illinois in stream crossings (Figure 39c).

Additional preventative and repair methods might involve reinforcement of the slope itself. Figure 40 shows two different methods for improvement: vertical micropiles (Figure 40a) and soil nails (Figure 40b). Both of these methods improve the stability of the soil, with micropiles increase FS to above 1.5, an acceptable design level. However, these methods bring significant cost and increase construction complexity, and do not provide any additional benefits compared with 2:1 slope (which increases costs but would not increase complexity). Thus they are not considered as viable alternatives in Task 6.

Finally, further analysis was performed on the effects of water seepage and infiltration due to rain events, using two-dimensional finite element analysis. First, seepage due to a differential in the water table is considered. Figure 41 shows a significant decrease in the FS (< 1) due to a large water table differential. Figure 42 shows a less significant decrease in FS (from 1.265 to 1.238) in the five days following a rain event. Both of these analyses, and in particular seepage effects, in combination with the results shown in Figure 37, indicate that water movement can cause a notable shift in the soil stability after high rainfalls, which might not have been observed immediately following construction.

Additional analysis was performed based on Illinois' slope-wall treatment method, used for high

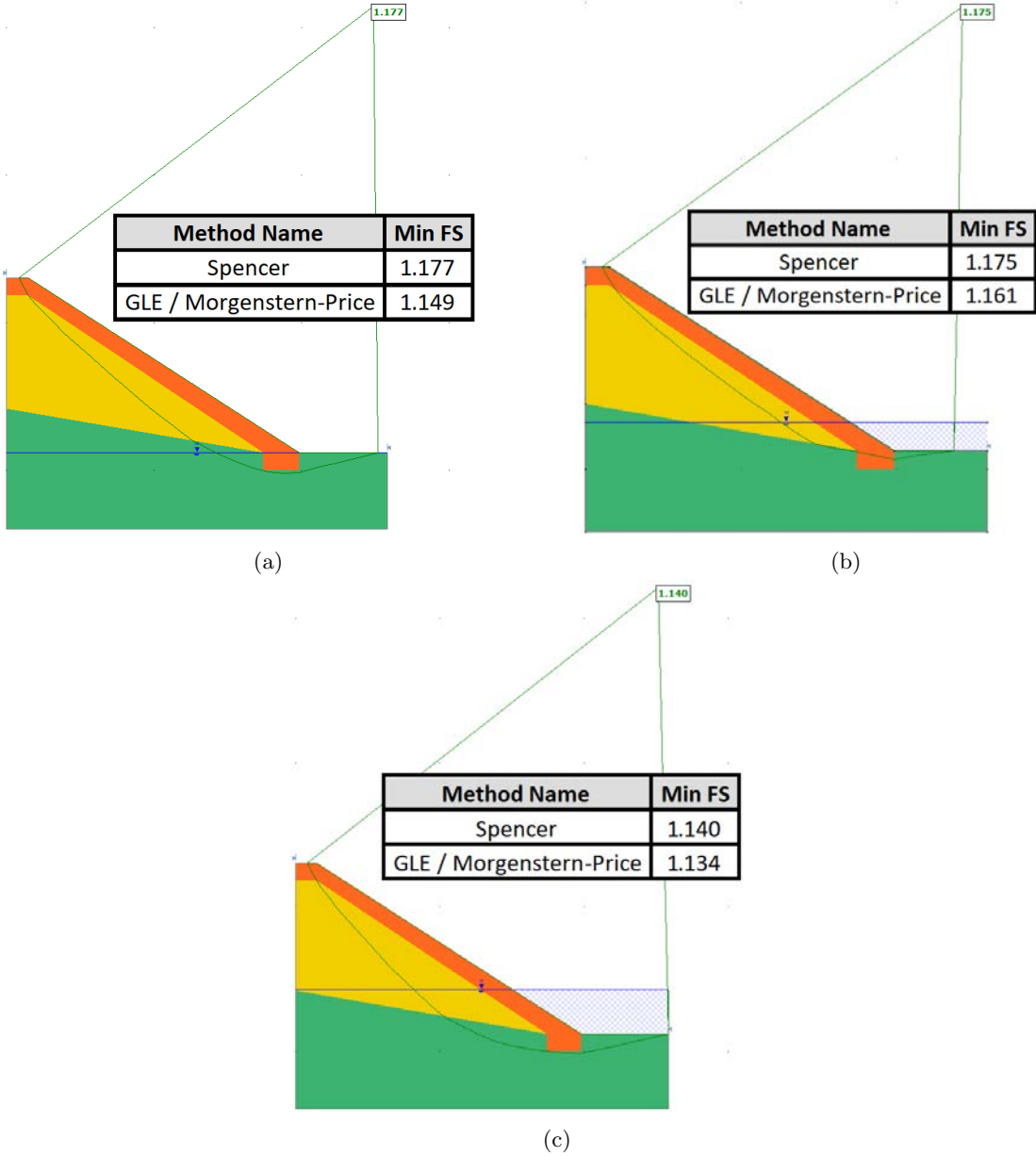

Figure 37: Consideration of varying water table levels. a) failure with a water table 0 ft above slope base, b) failure with a water table 3 ft above slope base, c) Failure with a water table 5 ft above slope base

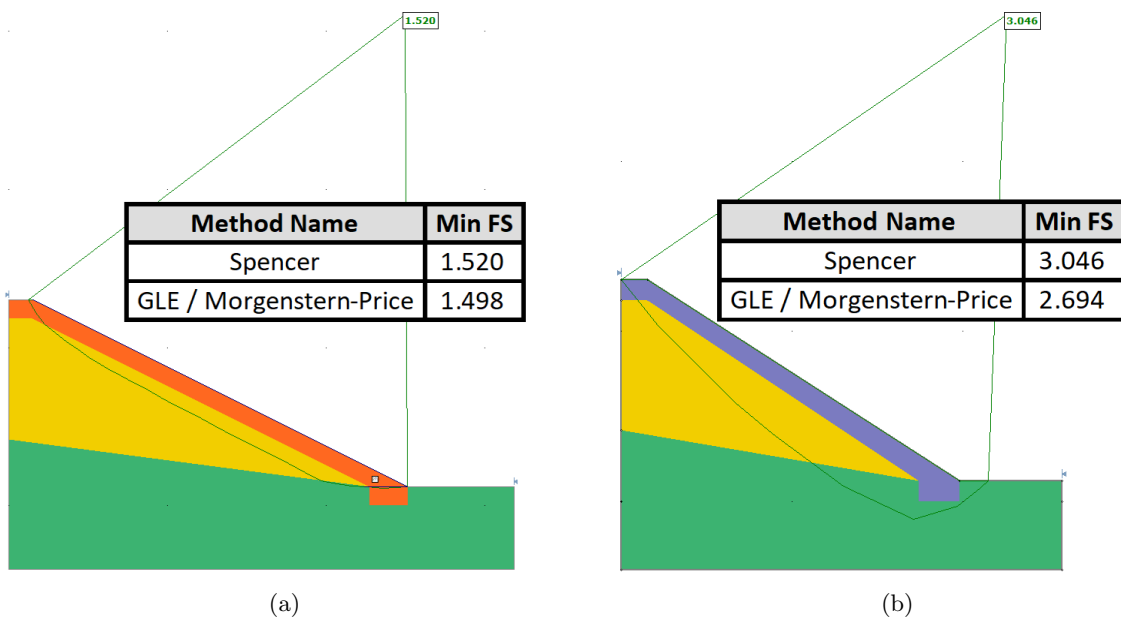

Figure 38: a) Analysis of reduce 2:1 slope, b) consideration of grouted riprap

water elevations in the state. It uses 6in+ concrete cover instead of riprap, and a deeper toe. It can be seen that this method does improve the stability, particular during high water elevations (see Figures 43a and 43b).

In conclusion, the two main concerns for slope stability of over-water bridges in Wisconsin are steep slopes and water management. If water drainage of the site is well designed, and the backfill of good quality, then it is likely there will be no critical concerns with abutment undermining. However, should either of these factors not be fully considered, then it is likely a 1.5:1 slope will not provide adequate long-term stability.

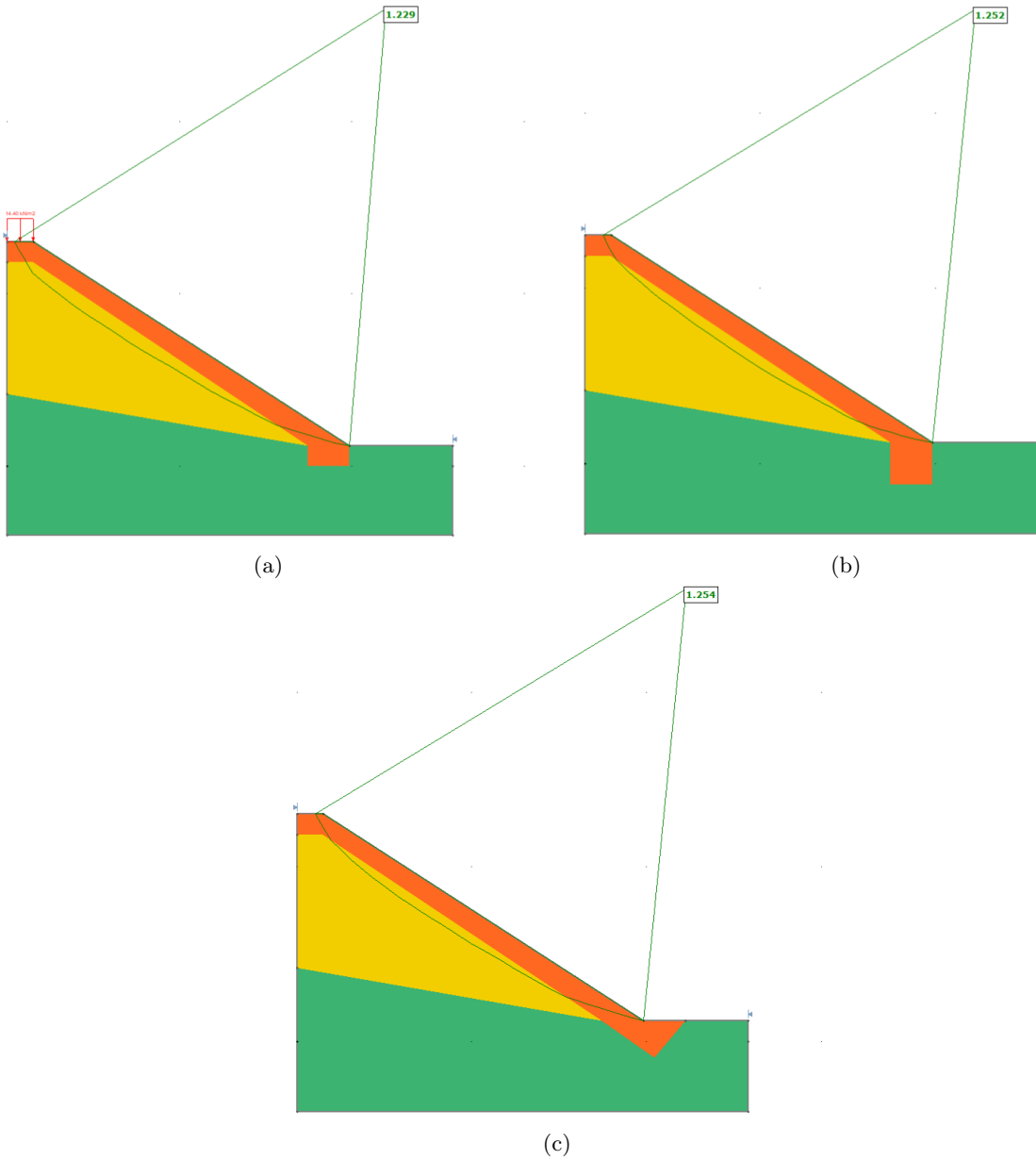
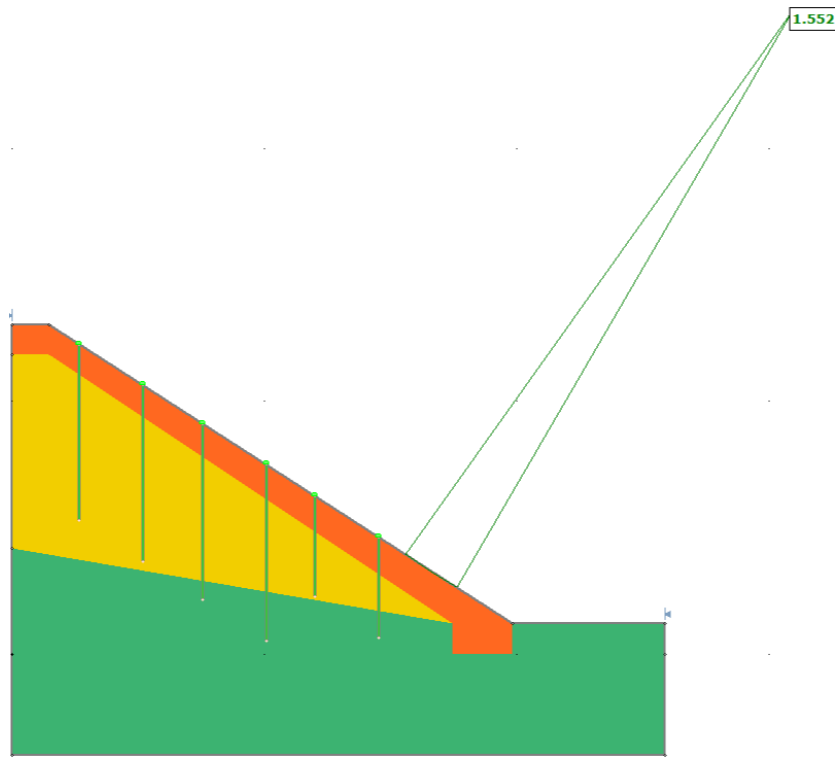
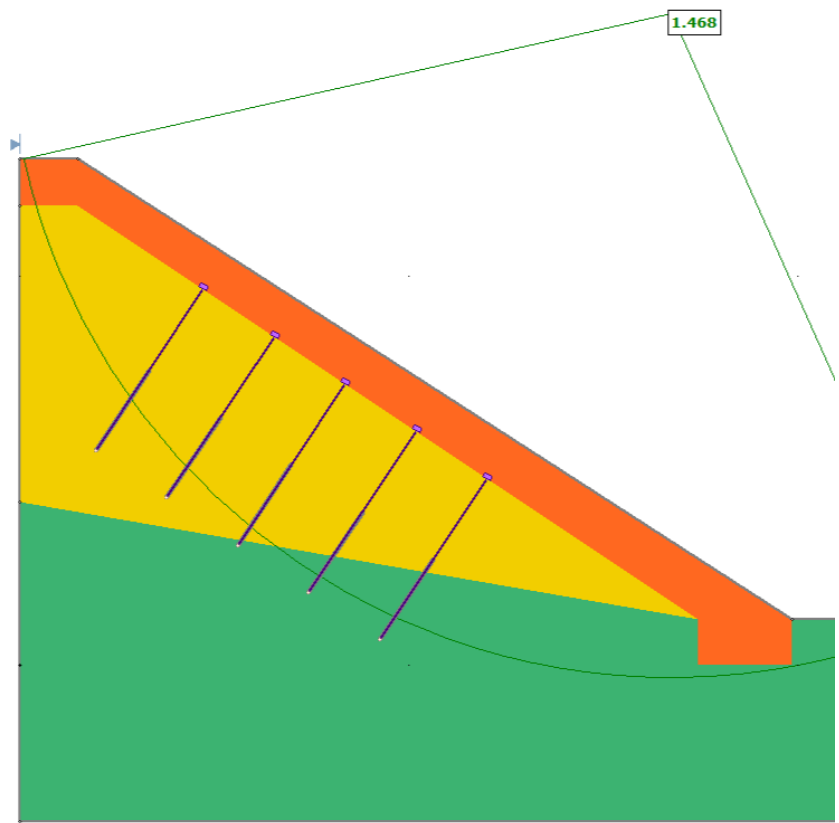

Figure 39: a) Simulation of concrete fill used to protect exposed abutment piles, b) simulation of extended riprap toe, c) alternative toe shape



(a)



(b)

Figure 40: Preventative design using a) slope piles, and b) soil stabilization

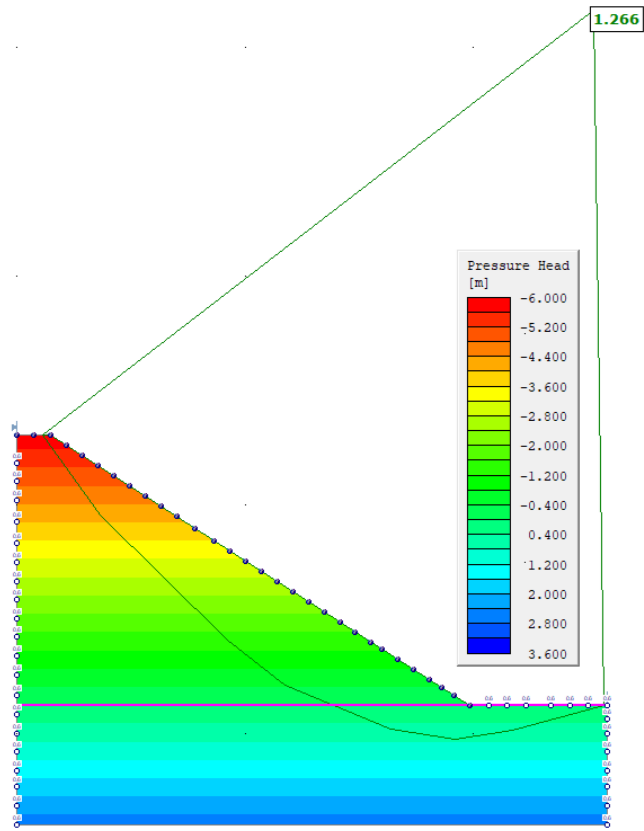

(a)

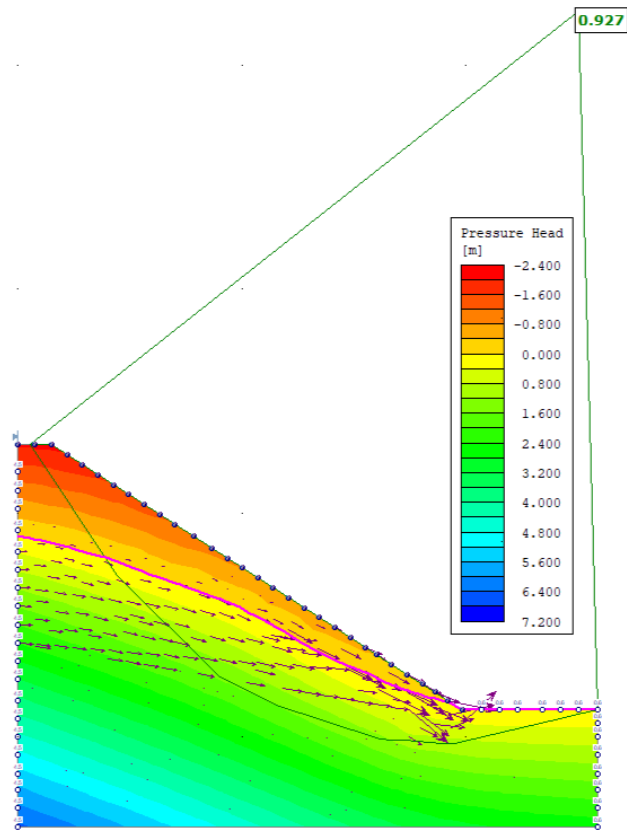

(b)

Figure 41: Seepage analysis with a) zero water table differential, b) 12 ft water table differential

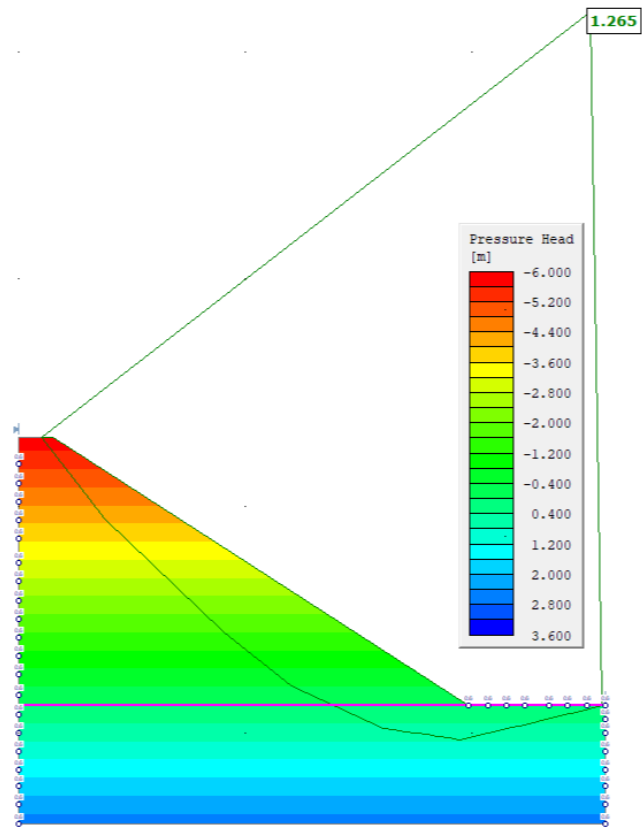

(a)

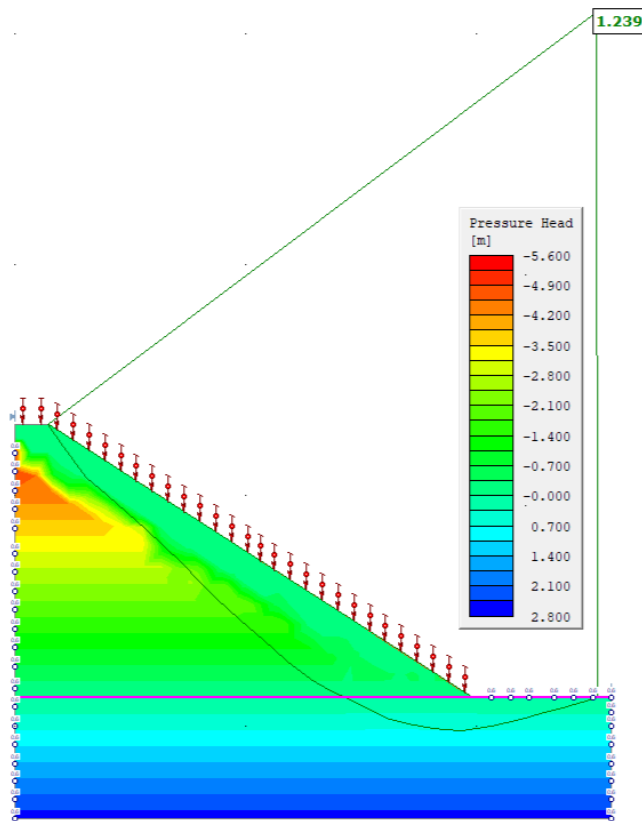

(b)

Figure 42: Rain infiltration a) immediately after rainfall, and b) 5 days after rainfall

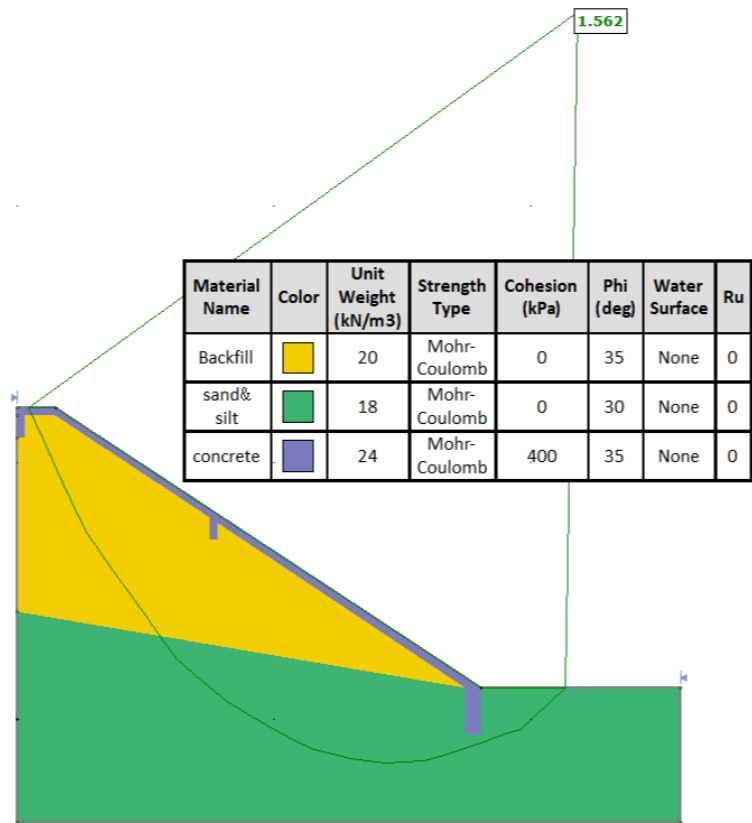

(a)

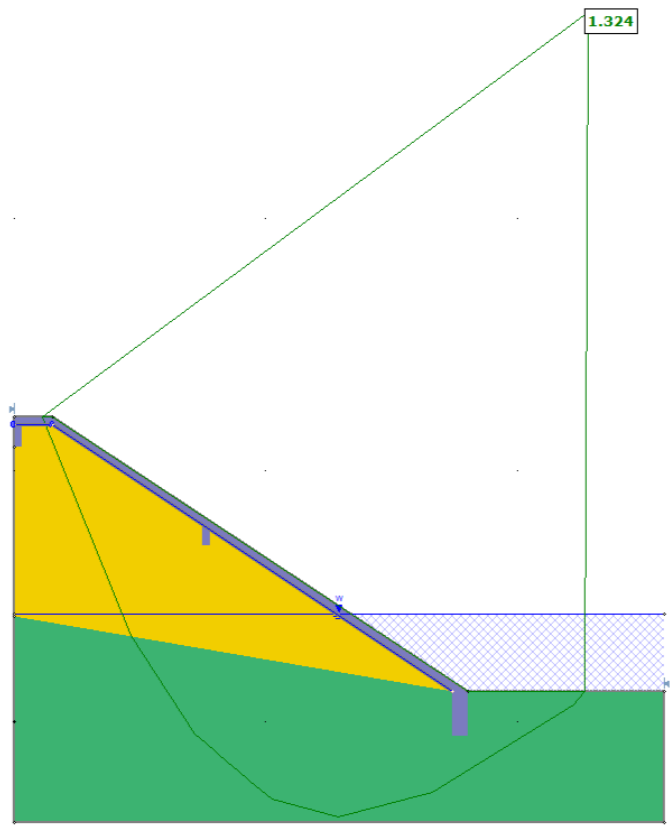

(b)

Figure 43: IL slope-wall treatment a) dry, and b) with elevated water levels

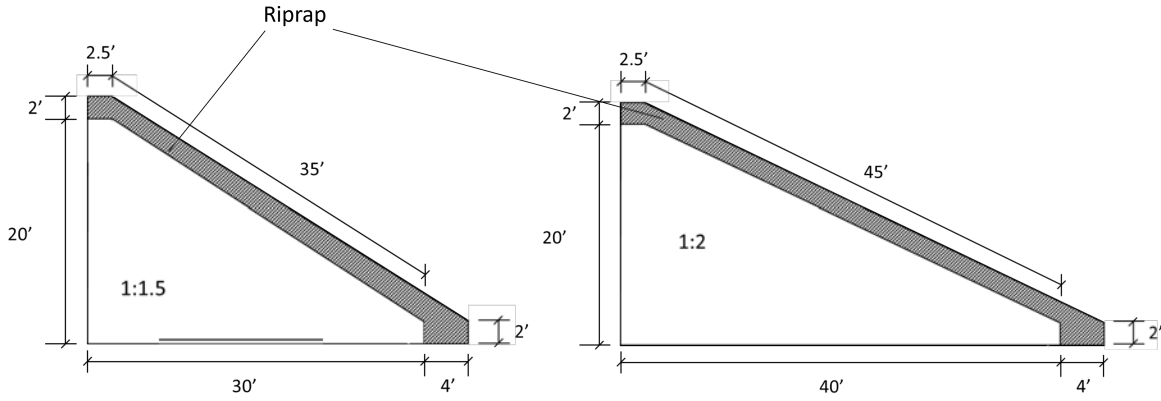

Figure 44: Bridge schematic, with a width of 40 ft.

Table 4: Cost of material for 2:1 slope

Item	Amount	Cost
Riprap	153 yd ³	\$7,650
Geofabric	200 yd ²	\$1,500
Exc. & Backfill	592 yd ²	\$21,904
Superstructure	11,200 ft ²	\$784,000
Total	C₂ =	\$815,000

Table 5: Cost of material for 1.5:1 (H:V) slope

Item	Amount	Cost
Riprap	123 yd ³	\$6,150
Geofabric	156 yd ²	\$1,170
Exc. & Backfill	444 yd ²	\$16,428
Superstructure	10,400 ft ²	\$728,000
Total	C_{1.5} =	\$751,700

T6 Life-cycle costs assessment according to slope inclination and protection method

The objective of Task 6 is the development of an informed decision-making strategy for selecting among alternatives identified during preceding Tasks. A versatile model will optimize the trade-off between minimum cost and maximum service life of Wisconsin over-water bridges, and ultimately yields the development slope protection protocol based on site-specific conditions. To estimate overall impact on Wisconsin budgets, information regarding statistics of state-wide abutment undermining from Task 2 (Section T2) is used to extrapolate from a single bridge cost analysis.

T6.1 Single bridge cost estimates

First, a simplified geometry is defined, with two schematics of slope 1.5:1 and 2:1 (H:V) (Figure 44), a width of 40 feet, and a length of 200 ft from toe to toe of abutment. From this, associated costs for the two slopes are calculated. It should also be noted that additional construction costs associated with the longer time to build of a larger bridge is not considered here, and as such the differential of superstructure costs due to a decrease in slope is underestimated.

The calculation of volumes for the bridge foreslopes are based on the dimensions shown in Figure 44. The associated cost of materials for both slopes are outlined in Tables 4 and 5.

Riprap	Geofabric	Superstructure
$V_{toe+berm} = 600/27$	$V_g^{1.5} = 40 \times 35/9$	$V_s^{1.5} = 40 \times (200 + 30 \cdot 2)$
$= 20 \text{ CUYD}$	$= 156 \text{ SQYD}$	$= 10,400 \text{ SQFT}$
$V_r^{1.5} = 20 + 40 \times (2 \cdot 35)/27$	$V_g^2 = 40 \times 45/9$	$V_s^2 = 40 \times (200 + 40 \cdot 2)$
$= 123 \text{ CUYD}$	$= 200 \text{ SQYD}$	$= 11,200 \text{ SQFT}$
$V_r^2 = 20 + 40 \times (2 \cdot 45)/27$		
$= 153 \text{ CUYD}$		

The cost of repairs must then be estimated under the assumption that the 1.5:1 (H:V) bridge will require additional maintenance due solely to its increased slope. It is assumed that the repairs will follow current SOP for WisDOT, which involves placing gravel, foam or concrete slurry underneath

Table 6: Maintenance histories for four bridges with recent secondary maintenance

Bridge	Year	Maintenance
B-07-12, STH 87	2013	Wedge Approaches
	2015	<i>Void Fill under Abutment</i>
	2017	Wedge Approaches
	2018	Replace Riprap
	2022	Wedge Approaches
B-07-24, STH 48	prior to 2014	<i>Void Fill under Abutment</i>
	2014	Replace Riprap
	2020	Wedge Approaches
B-07-32, STH 70	2022	<i>Void Fill under Abutment</i>
	2000	Replace Riprap
	2002	<i>Void Fill under Abutment & Replace Riprap</i>
	2013	Replace Riprap
B-07-45, STH 35	2022	Replace Riprap
	2013	Mudjack Approaches
	1011	<i>Void Fill under Abutment & Replace Riprap</i>

the abutment for foundation protection, but otherwise not considering adjustments such as re-grading the slope (i.e. these are repairs to mitigate damage, not to remove the cause of the problem).

According to WisDOT, the cost range for primary repairs via the County Highway Department, through the Routine Maintenance Agreements, would range from \$7,000 - \$10,000 for the average repair (e.g. filling a void underneath the abutment less than 6 inches). As this repair is not preventative, the slope will continue to move, and this must be repeated every 10-20 years. Extreme cases such as the current project for B-58-75 (budgeted at \$1.5 million) are not considered, as it is assumed that the results of this report and appropriate adjustment to guidelines will reduce the extent to which such cases will occur. If site conditions encountered during design geotechnical work are not appropriate for 1.5:1 (H:V) slope, adjustments to the slope angle and foundation can be devised to reduce the risk of slope stability issues. Moreover, the issue at B-58-75 is not typical, nor an indicator of overall trends in the state.

Additionally, there will likely be secondary repairs necessary, such as

- Mill & Overlay, or wedging for asphalt approach roadway
- Mudjacking/Foamjacking for concrete approach roadway
- Placement of new riprap to replace the riprap sloughing down the slope

As an example, WisDOT provided relevant maintenance history for a selection of four bridges which received continual maintenance - see Table 6. This is not a complete list of the maintenance repairs on these four bridges, and wedging approaches were usually completed by the county and not documented.

These secondary maintenance items occur more frequently due to the lower tolerance for settling of the approach; WisDOT engineers estimated roughly two - three times as often as the primary maintenance of void fill under the abutment. As such, total expected maintenance is comprised of the following, for a 1.5:1 (H:V) bridge:

1. Void fill under the abutment: \$10,000 every 10 years OR \$7,000 every 20 years
2. Wedging for asphalt approach: \$1,500 - \$3,500 every 3 - 5 years
OR
Mill & Overlay for asphalt approach: \$7,500 - \$15,000 every 7 - 15 years
OR
Mudjacking/foamjacking for concrete approach: \$5,000 - \$7,500 every 3 - 5 years
3. Placement of new riprap: \$2,500 - \$10,000 every 10 - 20 years*

*Wisconsin has roughly twice as many asphalt approaches as concrete approaches; asphalt was taken for the lower bound and concrete for the upper bound.

From these, two limits are considered, taking the upper and lower extremes, and considering a lifetime of 75 years per bridge.

On the higher end, \$10,000 every 10 years + \$7,500 every 3 years + \$10,000 every 10 years = \$338,000 = R_U in repairs. On the lower end, \$7,000 every 20 years + \$1,500 every 5 years + \$2,500 every 20 years = \$58,000 = R_L in repairs.

On the other hand, stabilization methods such as soil nails may greatly reduce or eliminate the need for increased maintenance costs. The costs such an intervention is not well documented, as it is rarely implemented for such a purpose. However, as an estimate, some numbers from Ohio DOT provide an expectation of roughly \$1,000-\$2,000 per linear foot [1]. For this bridge schematic, that would be an additional construction cost of \$40,000-\$80,000, with an assumed reduction in maintenance cost of about 90%, resulting in \$5,800 < R_A < \$33,800 in maintenance cost. This may be worth further consideration by WisDOT, but without more precise values the research team did not find it relevant to include as a primary consideration at this time.

T6.2 Associated long-term costs for Wisconsin

Taking the values calculated previously, the overall impact on Wisconsin bridges can be considered. Taking $X_{rec}=1.9\%$ as the expected percent of failure of 1.5:1 (H:V) over-water bridges, three expressions are compared for Z number of built bridges: upper-bound and lower-bound expectations for 1.5:1 and the flat expectation of 2:1.

Should no changes be made to the current design standards, it is calculated that the expected associated costs are bounded by:

$$\begin{aligned}
 V_{1.5L} &= (C_{1.5} + R_L X_{rec})Z & V_{1.5U} &= (C_{1.5} + R_U X_{rec})Z \\
 &= (752,000 + 58,000 \cdot 0.019)Z & &= (752,000 + 338,000 \cdot 0.019)Z \\
 &= \text{\$753,000}Z & &= \text{\$758,000}Z
 \end{aligned} \tag{1} \tag{2}$$

While the cost after decreasing the standard slope to 2:1, and assuming no stability-related maintenance, is estimated as:

$$\begin{aligned}
 V_2 &= C_2 Z \\
 &= \text{\$815,000}Z
 \end{aligned} \tag{3}$$

It can be seen that despite the additional cost of slope-specific primary and secondary repairs, the cost savings of a 1.5:1 (H:V) bridge are indeed notable, roughly \$60,000 in savings per bridge. There are some qualifications to this conclusion, as the secondary repairs are much less documented. Furthermore, the rate of slope failure, X_{rec} , was roughly estimated. However, as the difference in construction cost is \$63,000, even in the upper bound for maintenance, the required failure rate would be 18.5%, such that

$$V_{1.5U}/Z = (752,000 + 338,000 \cdot 0.185) = \$815,000$$

This is well beyond reasonable variation in X_{rec} , as discussed in Section T2. Additionally, as discussed above, it would likely be more cost effective to include slope stabilization methods. Though this results in higher upfront capital cost, it is still below expected construction costs for 2:1, and it would reduce labor cost over time (not considered in this study), compared to current 1.5:1 design.

Heavy riprap is used for slope protection at stream crossings due to its superior performance over medium random riprap. In general, due to the favorable performance and relatively low cost of geotextile fabrics, they are used under heavy riprap whenever heavy riprap is specified for a project.

Many factors influence the criteria used to select end slopes. These include:

1. The type of soil. (granular, cohesive, borrow or in-situ)
2. Type and impact of a failure to stream/roadway/structure.
3. Type of abutment foundation support. (spread footings vs. piles)
4. History of the existing slopes at structure replacement sites.
5. Additional bridge costs when structures are lengthened due to flatter slopes.

The current standard for slopes is 1.5:1 (H:V). However, for conditions where the vertical height of fill from berm to toe of slope exceeds 15 feet, consider flattening slopes to 2:1, or breaking up the slope by providing a plateau area halfway through the slope.

Furthermore, if slope soil materials are "fairly granular", use current standards. For other soil types, flatten slopes to 2:1. If existing problems are noted or there is no historical information at the site, analyze site geometry to determine slope.

Refer to the Standard for Placement of Heavy Riprap at River Crossings for placement of heavy riprap. Any additional riprap not covered by the standard is not part of the structure plans

T7 Final recommendations and guidelines

Results from Task 6 indicate little need for expansive revisions to the current design guidelines. Rather, the research team suggests focusing on the standards guiding the choice of bridge slope discussed in Chapter 15.

In particular, proposed revisions to Section 15.2 of the WisDOT Bridge Manual language include adding an explicit statement about the possibility of movement at the surface for 1.5:1 (H:V) slopes. Suggested modifications assert the importance of quality fill, adequate drainage, and compliance to specifications in construction. Poor quality fill is of particular concern. When free-draining, compactable soils are not available, slopes of 2:1 should be considered.

Considering the rate of 1.5:1 over-water bridges, it also appears that the criteria for flattening may be underestimating sites of concern. The team recommends modifying the criteria by a sufficient amount to increase the design cases requiring flattening by roughly 2%, which may mitigate the current rate of slope failure. Further work may be required to identify the specific site criteria for which such mitigation would occur, for example a vertical height of 8 ft, rather than 10 ft, as the cut-off requirement. The current language is given in Ref. 1 for reference, and recommended points of modification are shown in Ref. 2.

Additional relevant sections of the Bridge Manual include Section 9.10 regarding granular materials, Section 10.2, regarding subsurface exploration, and Chapter 12 regarding abutment design. The research team does not see the need to change these sections.

The research team does suggest changes to the typical remediation of exposed abutment piles. It was observed during site visits, and confirmed with WisDOT engineers, that a flowable concrete slurry is typically used to plug gaps under exposed abutments. However, such slurry adds notable weight to the abutment slope, which will increase the rate of slope movement and increase further exposure of the abutment (as such methods are not treating the problem, but merely minimizing impacts to the deterioration of abutment foundations). It is the recommendation of the research team that an expanding foam or similar lightweight material would provide equivalent purpose, with significantly reduced added weight. Such a method is understood to be considered for some bridge repairs already, but is recommended here as standard practice for exposed piles resulting from slope instability.

Heavy riprap is used for slope protection at stream crossings due to its superior performance over medium random riprap. In general, due to the favorable performance and relatively low cost of geotextile fabrics, they are used under heavy riprap whenever heavy riprap is specified for a project.

Many factors influence the criteria used to select end slopes. These include:

1. The type of soil. (granular, cohesive, borrow or in-situ)
2. Type and impact of a failure to stream/roadway/structure.
3. Type of abutment foundation support. (spread footings vs. piles)
4. History of the existing slopes at structure replacement sites.
5. Additional bridge costs when structures are lengthened due to flatter slopes.

The current standard for slopes is 1.5:1 (H:V). However, for conditions where the vertical height of fill from berm to toe of slope exceeds **10 feet 8 ft** [**consider further research to determine if this limit is sufficient**] consider flattening slopes to 2:1, or breaking up the slope by providing a plateau area halfway through the slope.

Furthermore, if slope soil materials are "fairly granular" **free-draining, compactable soils** [**consider more nuanced definitions and requiring some level of analysis discussed in Chapter 10 regardless of material**], use current standards. For other soil types, flatten slopes to 2:1. If existing problems are noted or there is no historical information at the site, analyze site geometry to determine slope.

Consider adding a short discussion of slope stability consequences here.

Refer to the Standard for Placement of Heavy Riprap at River Crossings for placement of heavy riprap. Any additional riprap not covered by the standard is not part of the structure plans

Conclusions

This study investigated an on-going trend in loss of slope protection of over-water bridge abutments in Wisconsin. Repairs for slope protection and maintenance of exposed abutment foundations are of continual concern for WisDOT; as such the department called for better understanding of the cause and potential solutions to this failure.

Final conclusions provide three avenues to address the observed behavior, summarized here and outlined in more detail below. First, WisDOT may make no changes to their current standard practices. This study showed that the loss of slope protection occurs infrequently and incurs minimal maintenance costs, such that continuing to address such loss as it occurs, without change, would not be an unreasonable solution. Second, WisDOT may change its standards in line with surrounding states, by means of defaulting to a 2:1 (H:V) slope. Though costly, such a solution would eliminate the majority of conditions resulting in such loss of protection. Finally, WisDOT may make small changes to current standards, following further investigation into the competing factors discussed in this report.

C1 Key conclusions on the current state of abutment protection

An initial hypothesis of scour-related concerns was found not to be the primary mode of failure, but rather slope instability identified as the more likely cause of loss of slope protection. This was supported by multiple avenues of investigation. First, information drawn from bridge inspections indicated a statewide trend of creeping movement, as opposed to sudden failures after high rainfall events (which was primarily occurring the southwest region, but not elsewhere; moreover, the southwest region also experienced the same creeping concern). Second, a survey sent to the DOTs of surrounding states highlighted Wisconsin as unique in defaulting to a 1.5:1 (H:V) slope for over-water bridges, as opposed to 2:1 slopes noted by all surrounding Midwest states. Indeed, surrounding states stated minimal concerns for the use of riprap as slope protection, indicating that neither scour or nor slope instability plays a significant role in bridge maintenance. Computational analysis supported the shift to a flatter

slope for increased stability and reduced need for maintenance.

Site visits further supported this conclusion, whilst also providing more information about the current state of over-water bridge abutments in general. As per WisDOT bridge manual, most riprap covered slopes designed to be on a 1.5:1 slope, where the top of the riprap is designed to be 2'-6" minimum from bottom of abutment concrete, with a flat berm at the slope of the slope. However, no observed bridges showed a berm of riprap, and the measured slopes were found to be on average much flatter than the 1.5:1 called out on plans (and assumed as built). Additional concerns due to poor drainage were present in some abutments as well, indicated seepage and related hydrological effects may be of concern. Further computational analysis supported such conclusions.

A review of the HSI database for all over-water bridges estimated that 2% of current in-use bridges in Wisconsin experience slope instability and related loss of abutment protection. Furthermore, this trend hold even for the most recent three decades, only decreasing to 1.9% of bridges built since 1990, indicating the failure is seen early on in the structures lifespan.

C2 Proposed guidelines for future over-water bridge design in Wisconsin

A simplified bridge design was used to estimate the effect on overall cost of a steeper slope, comparing the savings due to a shorter superstructure with the assumed increased maintenance costs. It was seen that despite the need for primary and secondary repairs related to abutment foundation protection, replacement of lost slope protection, and serviceability of the roadway approach, the cost savings of a steeper abutment slope are greater than the associated maintenance costs. A slope failure rate of greater than 15% would be required, based on assumed line item costs and a simplified bridge design, for 2:1 slopes to result in equivalent costs. It is thus recommended that no change be made to the prescribed slope of over-water bridges in Wisconsin.

However, as the Wisconsin Bridge Manual does provide situational guidance for when 2:1 slopes should be implemented, this study suggests that increased nuance in the selection criteria would reduce even further the observed rate of failure, to reduce maintenance costs associated with replacement of riprap and protection of abutment foundations. These recommendations focus on characterization of abutment fill soil, to ensure correct drainage and strength. A secondary focus is on the choice of remediation material used for protection of exposed abutments due to slope movement. Site visits and discussions with WisDOT engineers showed concrete slurry as the common choice for gap 'repair'. However, it is recommended that a lightweight material such as expanding foam would equally serve the intended purposes without contributing to further slope movement due to added weight.

C3 Potential points of further research

Due to the shift in project approach, not all avenues were fully investigated. Two potential areas of refinement are of particular interest.

First, quantification of the number of over-water bridges experiencing slope instability was only investigated at the highest level. Further refinement of both the method of characterization and the number of failure modes might be explored to better predict the future rate of such instability. Such refinement may shift the balance in costs to either increasing support or possibly condemn 1.5:1 (H:V) as the cost-effect design choice. Similarly, cost estimates associated with repairs should be improved beyond provided approximations via improved documentation and tracking, as said costs are a primary factor in the final expense comparison.

Second, stabilization methods such as micropiles, tiebacks, or soil nails may prove to be a more cost effective method to reducing slope movements and riprap loss, in comparison to flattening abutment slope. This was presented briefly in this study, but information concern construction costs of such methods was not available with respect to abutment stabilization for the express purposed of slope instability and over-water bridges. As such, the relative costs within the scope of this project were determined to be too uncertain for direct comparison. Future exploration of stabilization methods would be worth additional funds.

Overall, the completed study shows clear indication of slope instability as a direct cause of loss of slope protection, and directly resulting from the choice of 1.5:1 (H:V) slopes as a cost-savings measure. However, increased maintenance does not negate these savings, and in conclusion this study recommends continuing the use of 1.5:1 slopes, with proposed adjustments to the Bridge Manual and

improved nuance to geotechnical considerations which might reduce the small percentage of bridges requiring such ongoing maintenance due to soil movement.

Appendix

A1 Identified bridges of concern

A1.1 Slope instability estimates

See attached for spreadsheet on bridges queried from the HSI for riprap failure and abutment undermining, and related shortlists for Task 2.

A1.2 Critical slope failure

Table A.1: Bridges identified as having critical slope failure concerns

Name	Bridge Design	Span Type	Span Length (ft)	Road
B-26-015	Deck Girder	Prestressed Concrete	72	STH 77-WISCONSIN AVE
B-12-024	Deck Girder	Prestressed Concrete	68	STH 179
B-12-042	Deck Girder	Prestressed Concrete	105	STH 35
B-12-076	Flat Slab	Cont. Concrete	34	USH 61
B-12-102	Deck Girder	Prestressed Concrete	100	STH 60
B-14-032	Haunched Slab	Cont. Concrete	50	USH 151 NB
B-14-064	Haunched Slab	Cont. Concrete	50	USH 151 SB
B-18-113	Deck Girder	Steel	146	USH 12
B-19-006	Deck Girder	Prestressed Concrete	105	USH 2-USH 141
B-21-003	Deck Girder	Prestressed Concrete	52	STH 32
B-22-617	Deck Girder	Steel	50	STH 11
B-28-010	Deck Girder	Prestressed Concrete	103	STH 19
B-30-051	Deck Girder	Prestressed Concrete	82	STH 50 WB-STH 83 NB
B-30-057	Deck Girder	Prestressed Concrete	82	STH 50 EB-STH 83 SB
B-35-020	Deck Girder	Prestressed Concrete	64	STH 17
B-35-032	Deck Girder	Prestressed Concrete	92	USH 51 SB
B-35-062	Deck Girder	Prestressed Concrete	120	USH 51 NB
B-35-063	Deck Girder	Prestressed Concrete	120	USH 51 SB
B-35-098	Deck Girder	Prestressed Concrete	60	STH 86
B-35-120	Deck Girder	Prestressed Concrete	38	USH 51 NB
B-37-006	Deck Girder	Steel	52	STH 153-FIR ST
B-37-202	Deck Girder	Prestressed Concrete	81	STH 29 WB
B-37-548	Deck Girder	Steel	53	STH 97-ALFRED ST
B-39-036	Deck Girder	Prestressed Concrete	56	USH51-IH39NB
B-43-016	Deck Girder	Prestressed Concrete	66	USH 8-STH 47
B-43-018	Deck Girder	Prestressed Concrete	88	USH 51
B-43-028	Deck Girder	Prestressed Concrete	75	USH 51
B-46-030	Deck Girder	Prestressed Concrete	70	USH 10
B-49-133	Haunched Slab	Cont. Concrete	52	STH 66
B-49-152	Deck Girder	Prestressed Concrete	120	STH 13/34 S over USH10
B-49-153	Deck Girder	Prestressed Concrete	120	USH 10 WB
B-49-154	Deck Girder	Prestressed Concrete	120	USH 10 EB
B-49-155	Deck Girder	Prestressed Concrete	45	USH 10 EB
B-49-156	Deck Girder	Prestressed Concrete	45	USH10 WB
B-49-157	Deck Girder	Prestressed Concrete	110	County Rd O
B-49-158	Deck Girder	Prestressed Concrete	85	USH 10 EB
B-49-159	Deck Girder	Prestressed Concrete	85	USH 10WB
B-49-160	Deck Girder	Prestressed Concrete	150	USH 10 EB
B-49-161	Deck Girder	Prestressed Concrete	150	USH 10 WB
B-49-169	Flat Slab	Concrete	38	STH 66EB
B-49-170	Deck Girder	Prestressed Concrete	75	STH66EB
B-49-174	Deck Girder	Prestressed Concrete	65	CTH X
B-50-026	Deck Girder	Prestressed Concrete	106	STH 13
B-51-057	Deck Girder	Prestressed Concrete	63	STH 36-STH 83 SB (Milwaukee Ave)
B-52-114	Flat Slab	Cont. Concrete	26	STH 80
B-58-075	Deck Girder	Prestressed Concrete	133	STH 29 W
B-58-093	Deck Girder	Prestressed Concrete	85	STH 29 EB
B-62-017	Deck Girder	Prestressed Concrete	47	USH 61-STH 131
B-62-105	Haunched Slab	Cont. Concrete	48	USH 14-USH 61
B-64-137	Deck Girder	Prestressed Concrete	92	IH 43 SB
B-71-008	Haunched Slab	Cont. Concrete	30	STH 73
B-71-159	Deck Girder	Prestressed Concrete	62	USH 10
B-39-047	Deck Girder	Prestressed Concrete	89	STH 73-MAIN ST

A2 Inclinometer monitoring data

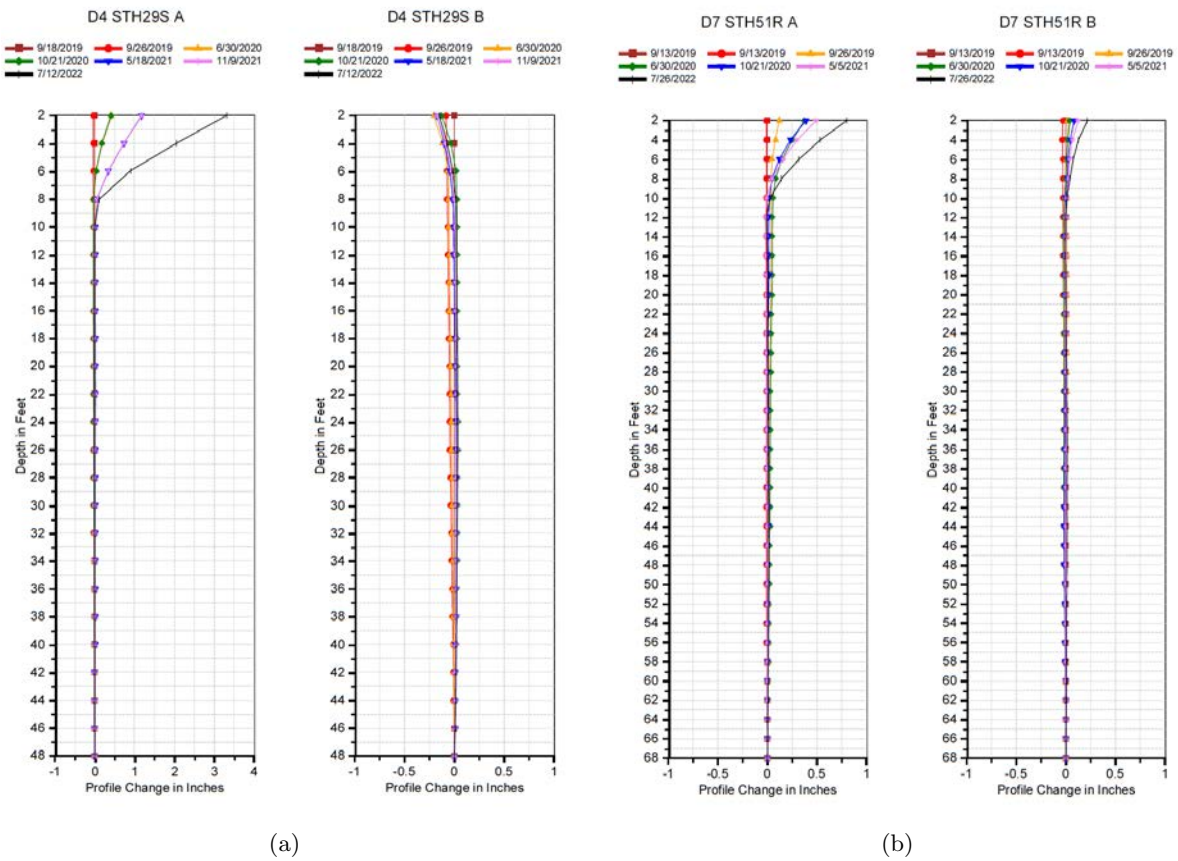

Figure A.1: Incliner data at bridges a) B-58-75 and b) B-43-18

A3 Supporting documents

References

- [1] *Ohio DOT Geotechnical Year in Review*, Lincoln, Nebraska, 2002. Ohio DOT.
- [2] FHWA (Federal Highway Administration). National bridge inventory, 2012.
- [3] LA Arneson, LW Zevenbergen, PF Lagasse, PE Clopper, et al. Evaluating scour at bridges. Technical report, National Highway Institute (US), 2012.
- [4] Abdul Karim Barbhuiya and Subhasish Dey. Local scour at abutments: A review. *Sadhana*, 29(5):449–476, 2004.
- [5] BD Barkdoll, BW Melville, and R Ettema. A review of bridge abutment scour countermeasures. In *Proc. of the 2006 World Environmental and Water Resources Congress, May 21-25, 2006, Omaha, Nebraska*, 2006.
- [6] AH Cardoso and R Bettess. Effects of time and channel geometry on scour at bridge abutments. *Journal of Hydraulic Engineering*, 125(4):388–399, 1999.
- [7] Wesley Cook, Paul J Barr, and Marvin W Halling. Segregation of bridge failure causes and consequences, 2014.
- [8] Subhasish Dey and Abdul Karim Barbhuiya. Clear-water scour at abutments in thinly armored beds. *Journal of Hydraulic Engineering*, 130(7):622–634, 2004.
- [9] Laursen E. and A. Toch. Scour around bridge piers and abutments”. *Bull*, 4, 1956.
- [10] Abazar Fathi and Seyed Mohammad Ali Zomorodian. Effect of submerged vanes on scour around a bridge abutment [j]”. *KSCE Journal of Civil Engineering*, 7):2281-2289, 2018.
- [11] Faith A Fitzpatrick, Marie C Pepler, Heather E Schwar, John A Hoopes, and Matthew W Diebel. Monitoring channel morphology and bluff erosion at two installations of flow-deflecting vanes, north fish creek, wisconsin, 2000-03. Technical report, U. S. Geological Survey, 2005.
- [12] Madeleine M Flint, Oliver Fringer, Sarah L Billington, David Freyberg, and Noah S Diffenbaugh. Historical analysis of hydraulic bridge collapses in the continental united states. *Journal of infrastructure systems*, 23(3):04017005, 2017.
- [13] D. Froehlich. Local scour at bridge abutments”. In *Proc. Natl. Conf. Hydraulic Engineering*, page 13–18, New Orleans, LA, 1989. Am. Soc. Civil Eng.
- [14] R. Garde, K. Subramanya, and K. Nambudripad. Study of scour around spur-dikes”. *J. Hydraul. Div., Am. Soc. Civ. Eng.*, 87:23–37, 1961.
- [15] Mohammad Akram Gill. Erosion of sand beds around spur dikes. *Journal of the Hydraulics Division*, 98(9):1587–1602, 1972.
- [16] J. Kandasamy. Abutment scour”. *Rep*, 458, 1989.
- [17] K.W. Khan and M.H. Chaudhry. Numerical modelling of flow around spur dikes”. In *Proc., 4 International Conference on Hydraulic Engineering Software HYDROSOFT/92*, 1992.
- [18] R.A. Kuhnle, C.V. Alonso, and F.D. Shields. Volume of scour holes for angled spur dikes”. *Proc., International Water Resources Engineering Conference. Part, 2(of 2)*, 1998.
- [19] R.A. Kuhnle, C.V. Alonso, and F.D. Shields. Geometry of scour holes associated with 90-degree spur dikes”. *Journal of Hydraulic Engineering*, 125(9), 1999.
- [20] T. Kwan. A study of abutment scour”. *Rep*, 451, 1988.
- [21] P.F. Lagasse, J.D. Schall, F. Johnson, Richardson E. V., and F. Chang. Stream stability at highway structures”. In *Report FHWA IP90-014, Hydraulic Engineering Circular 20*. Federal Highway Administration, 1995.

- [22] P.F. Lagasse, P.E. Clopper, L.W. Zevenbergen, and L.W. Girard. *NCHRP Report 593: Countermeasures to Protect Bridge Piers from Scour*". National Cooperative Highway Research Program, Washington DC, 2007.
- [23] H. Liu, F. Chang, and M. Skinner. "Effect of bridge construction on scour and backwater", 1961.
- [24] R. Mayerle, F.M. Toro, and S.S.Y. Wang. "Verification of a three-dimensional numerical model simulation of the flow in the vicinity of spur dikes". *Journal on Hydraulic Research*, 33(2), 1995.
- [25] J.A. Maza Alvarez. "Design of groynes and spur dikes". In *Proc., 1989 National Conference on Hydraulic Engineering*, 1989.
- [26] Bruce W Melville and Robert Etema. "Bridge abutment scour in compound channels. In *Stream Stability and Scour at Highway Bridges: Compendium of Stream Stability and Scour Papers Presented at Conferences Sponsored by the Water Resources Engineering (Hydraulics) Division of the American Society of Civil Engineers*, pages 428–442. ASCE, 1999.
- [27] B.W. Melville and S.E. Coleman. *Bridge scour*". Water Resources Publications, Highlands Ranch, USA, 2000.
- [28] N. Muneta and Y. Shimizu. "Numerical analysis model with spur-dike considering the vertical flow velocity distribution". *Proc., Japan Society of Civil Engineering*, page 2–2, 1994.
- [29] New York State Thruway Authority. "Thruway bridge collapse from 1987, Apr 2017. URL <https://www.uticaod.com/picture-gallery/news/disaster/2017/03/31/gallery-thruway-bridge-collapse-from/505740007/>.
- [30] N. Rajaratnam and Nwachukwu B. A. "Flow near groin-like structures". *J. Hydraul. Eng., Am. Soc. Civ. Eng.*, 109:463–480, 1983.
- [31] E. Richardson and J. Richardson. "Discussion of 'pier and abutment scour: integrated approach' by b w melville". *J. Hydraul. Eng., Am. Soc. Civ. Eng.*, 124:771–772, 1998.
- [32] EV Richardson and SR Davies. "Evaluating scour at bridges. 3rd edn. us department of transportation, hec 18. Technical report, FHWA-IP-90-017, 1995.
- [33] E.V. Richardson and D.B. Simons. "Use of spurs and guidebanks for highway crossings". *Second Bridge Engineering Conference*, 950, 1984.
- [34] E.V. Richardson, L.J. Harrison, and S.R. Davis. *Evaluating Scour at Bridges*". Report FHWA-IP-90-017, Highway Engineering Circular 18. Federal Highway Administration, 1991.
- [35] M.M. Soliman, K.M. Attia, M.M. Kotb, A.M. Talaat, and A.F. Ahmed. *Spur dike effects on the river Nile morphology after high Aswan dam*". Proc., Congress of the International Association of Hydraulic Research, Part A, 1997.
- [36] Terry W Sturm and Nazar Sadiq Janjua. "Clear-water scour around abutments in floodplains. *Journal of Hydraulic Engineering*, 120(8):956–972, 1994.
- [37] K. Suzuki, M. Michiue, and O. Hinokidani. "Local bed form around a series of spur dikes in alluvial channel". In *Proc., 22nd Congress of the International Association of Hydraulic Research*, 1987.
- [38] C. Tey. "Local scour at bridge abutments". *Rep.*, 329, 1984.
- [39] W. Wong. "Scour at bridge abutments". *Rep.*, 275, 1982.
- [40] N. Zaghoul. "Local scour around spur-dikes". *J. Hydrol.*, 60:123–140, 1983.
- [41] N. Zaghoul and J. McCorquodale. "A stable numerical model for local scour". *J. Hydraul. Res.*, 13:425–444, 1975.