



**Table of Contents**

39.1 General .....3

    39.1.1 Introduction.....3

    39.1.2 Sign Structure Types and Definitions .....3

    39.1.3 Additional Terms .....5

    39.1.4 OSS Selection Criteria .....5

    39.1.5 Cantilever OSS Selection Criteria .....6

    39.1.6 Full Span OSS Selection Criteria .....7

    39.1.7 Butterfly and Butterfly Truss OSS .....8

    39.1.8 Design Process .....8

39.2 Materials .....9

39.3 Specifications .....10

    39.3.1 LRFD Design.....10

    39.3.2 Other Specifications and Manuals.....10

39.4 Design Considerations .....11

    39.4.1 Roadside Signs .....11

    39.4.2 Overhead Sign Structures (OSS).....11

        39.4.2.1 General.....11

        39.4.2.2 Vehicular Protection .....12

        39.4.2.3 Vertical Clearance .....12

        39.4.2.4 Lighting and DMS Inspection Catwalks .....12

        39.4.2.5 Signs Mounted on the Side of Grade Separation Bridges .....13

        39.4.2.6 Sign Structures Mounted on Bridge Pedestals.....13

    39.4.3 LRFD Requirements and WisDOT Guidance for OSS Design.....14

        39.4.3.1 Loads, Load Combinations, and Limit States .....14

        39.4.3.2 Serviceability .....16

        39.4.3.3 Fatigue.....16

        39.4.3.4 Connection Design .....16

    39.4.4 OSS Standard Designs .....17

    39.4.5 OSS Non-Standard Designs .....17

    39.4.6 OSS Contractor Designed.....18

39.5 Geotechnical Guidelines .....19

    39.5.1 General .....19



39.5.2 Standard Foundations for OSS ..... 19

    39.5.2.1 General..... 19

    39.5.2.2 Design Parameters Used for Standard Foundation Design .....20

39.5.3 Standard Base Reactions for Non-Standard Foundation Design.....21

39.5.4 Subsurface Investigation and Information .....21

39.6 Appendix – OSS Limiting Parameters .....22

39.7 Design Examples .....25



### **39.1 General**

#### 39.1.1 Introduction

Signing is an integral part of the highway plan and as such is developed with the roadway and bridge design. Sign support structures are divided into two categories: Roadside signs, and Overhead Sign Structures (OSS). Roadside signs are designed and specified by the roadway engineer. OSS are designed by a Department (in-house or consultant) structural engineer or by a contractor, depending on the type of OSS.

Generally, an OSS is comprised of three components: the sign(s), the structure, and the foundation. Signage details are provided in the WisDOT Sign Plate Manual referenced below. This chapter of the WisDOT Bridge Manual (BM) governs the design of the structure and the foundation for OSS.

Regional traffic engineers determine the type of overhead sign structure that meets the signage needs for a particular project. Selection guidance and information is provided in the Facilities Development Manual (FDM) 11-55-20. That selection is communicated to the Bureau of Structures through the SSR submittal process.

The responsibility for developing contract plans depends on the type of sign structure selected and may be the role of Bureau of Structure staff, Regional staff, or engineering consultants.

#### 39.1.2 Sign Structure Types and Definitions

Roadside Sign: Refers to roadside signs supported on ground mounted posts adjacent to roadways. Ground mounted sign support posts are not considered “structures” and as such, are not assigned a structure number. See WisDOT Sign Plate Manual for details.

<https://wisconsin.gov/Pages/doing-business/local-government/traffic-operations/manuals-and-standards/signplate/signplate.aspx>

Overhead Sign Structure (OSS): Refers to structural supports for mounting signs over a roadway. OSS are assigned a structure number and inventoried in WisDOT’s Highway Structures Information (HSI) system. These structures are included on the section 8 structure sheets of a contract plan set.

In prior editions of the Bridge Manual there were two categories of overhead sign structures - “Sign Bridges” and “Overhead Sign Supports (OHSS)”. Sign bridges were Department designed, and OHSS were contractor designed. While the roles of design remain the same, this edition shifts away from that terminology, instead focusing on terminology that best describes the geometric characteristics of the sign structure.

[Table 39.1-1](#) summarize OSS types used by WisDOT:

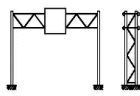
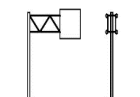
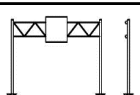
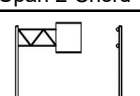
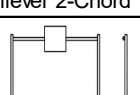
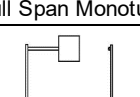
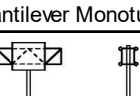
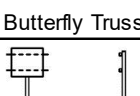
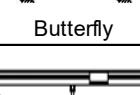
Overhead Sign Structure Type	Description	Standard Structure Design	Standard Foundation Design
 Full Span 4-Chord Truss	A 4-chord space truss with dual, trussed vertical support posts at each end. Used to support large Type I static highway sign panels and Dynamic Message Signs (DMS). Typically used over multi-lane state highways and interstate routes.	Yes	Yes
 Cantilever 4-Chord Truss	A 4-Chord space truss with a single vertical support post. Used to support large Type I static highway sign panels and DMS. Commonly used to span over the outside lanes of multi-lane state highways and interstate routes to delineate exit lanes and ramps.	Yes	Yes
 Full Span 2-Chord Truss	A 2-chord planar truss with single vertical support posts at each end. Used to support Type II and smaller Type I static signs and DMS over roadways and state highways.	No	Yes
 Cantilever 2-Chord Truss	A 2-chord planar truss with a single vertical support post. Used to support Type II and smaller Type I static signs and DMS over roadways and state highways.	No	Yes
 Full Span Monotube	Similar to a Full Span 2-Chord Truss but with only a single horizontal sign support member. Used to support small Type II static signs.	No	Yes
 Cantilever Monotube	Similar to a Cantilever 2 -Chord Truss but with only a single horizontal support member. Used to support small Type II static signs.	No	Yes
 Butterfly Truss	A 4-Chord space truss with a centrally located single vertical support post used to support DMS. Typically used in the medians of multi-lane interstate routes.	No	No
 Butterfly	Similar to a Butterfly Truss but with multiple monotube horizontal sign support members. Structures may include a light pole attached to the top of the column.	Yes	Yes
 Bridge Mounted Sign Support	Sign support brackets to mount signs to the sides of grade separation highway bridges over the underpass roadway. These are typically used in special circumstances where other OSS types cannot be used.	No	NA

**Table 39.1-1**  
WisDOT Overhead Sign Structure Types



### 39.1.3 Additional Terms

**Type I Sign:** Larger signs on an extruded aluminum base material, typically mounted on steel I-beams. Large guide and message signs with green backgrounds on interstate routes are Type I signs.

**Type II Sign:** Signs consisting of direct applied message on either plywood or sheet aluminum base material, typically mounted on wood or steel posts.

**Dynamic Message Sign (DMS):** An electronic traffic sign, often used in urban settings to inform drivers of unique and variable information. These signs are generally smaller in wind loaded area than Type I signs, but are heavier and load the truss eccentrically.

**OSS Standard Designs:** A group of pre-designed sign structures. The standard design includes both the structure and its foundation. The limitations for use is provided in section [39.1.5](#) and [39.1.6](#). See for further information on OSS Standard Designs.

**OSS Non-Standard Design:** Refers to sign structures that fall outside the OSS Standard Design parameters. It also applies to sign structure types not covered by standard design. These sign structures require a structural engineer provide a unique individual design of the structure and/or its foundation. See [39.4.5](#) for further information on OSS Non-standard Designs.

**OSS Contractor Designed:** Refer to sign structures (including anchor rods) that are designed and detailed by the contractor as part of the construction contract. The limitations for use is provided in sections [39.1.5](#) and [39.1.6](#). The contractor does not design the foundation. For this, pre-designed foundations are available for use with these types of sign structures. See [39.4.6](#) for further information on OSS Contractor Designed.

**OSS Standard Design Drawings:** Refers to a library of WisDOT developed detail drawings for the *OSS Standard Designs* and the foundations for *OSS Contractor Designed*, otherwise indicated by a “yes” in [Table 39.1-1](#). These standard design drawings are inserted into the contract plans with no additional design or detailing effort required.

### 39.1.4 OSS Selection Criteria

Chapter 11-55-20 of the Facilities Development Manual (FDM) provides selection guidance for determining sign structure type. The selection guidance was developed based on the design limitations of [Table 39.1-1](#) and [Table 39.1-2](#), and the information provided in the OSS Standard Design Drawings.



39.1.5 Cantilever OSS Selection Criteria

Cantilever OSS Type	Design	Cantilever Length <sup>1</sup>	Vertical Support Height <sup>1</sup>	Static Sign Total Area & Max. Dimensions <sup>2</sup>	OR	DMS Total Area & Weight <sup>1</sup>
Monotube	Contractor Designed	40'-0" Max.	25'-0" Max. Column Base Plate to CL of Monotube Arm	Sign Area ≤ 75 SF Max. Sign Height ≤ 5'-0"		Not Used
2-Chord Truss	Contractor Designed	40'-0" Max. (static) / 20'-0" Max. (DMS)	27'-0" Max. Column Base Plate to CL of Top Chord	Sign Area ≤ 150 SF Max. Sign Height ≤ 10'-0"		13'-9"W x 8'-0"H Max. 750 Lbs. Max
4-Chord Truss	Standard Design	20'-0" Min. 30'- 0" Max. <sup>2</sup>	30'-0" Max. Column Base Plate to CL of Top Chord	Sign Area ≤ 264 SF Max. Sign Height ≤ 15'-0"		19'-0"W x 6'-0"H 2,500 Lbs. Max.
4-Chord Truss	Standard Design	>30'-0" 38'-0" Max. <sup>2</sup>	30'-0" Max. Column Base Plate to CL of Top Chord	Sign Area ≤ 240 SF Max. Sign Height ≤ 15'-0"		19'-0"W x 6'-0"H 2,500 Lbs. Max.
4-Chord Truss	Non-Standard Design	>38'-0"	Column Height Exceeds Limit for Standard Design	Sign Area or Max. Sign Height Exceeds Limits For Standard Design		DMS Dimensions or Weight Exceeds Limits For Standard Design

**Table 39.1-2**  
Cantilever OSS Selection Criteria

Note 1: The limiting parameters of length, height and sign area are depicted in 39.6 for Contractor Designed OSS and on the Standard Design Drawings for the 4-Chord OSS.

Note 2: Static Type I sign panels may extend 1'-0" beyond end of Cantilever 4-Chord Truss.



39.1.6 Full Span OSS Selection Criteria

Full Span OSS Type	Design	Span Length <sup>1</sup>	Vertical Support Height <sup>1</sup>	Static Sign Total Area & Max. Dimensions	OR	DMS Max. Dimensions & Max. Weight <sup>1</sup>
Monotube	Contractor Designed	40'-0" Min. 75'-0" Max.	25'-0" Max. Column Base Plate to CL of Monotube Arm	Sign Area ≤ 150 SF Max. Sign Height ≤ 5'-0"		Not Used
2-Chord Truss	Contractor Designed	40'-0" Min. 100'-0" Max. (static) / 70'-0" Max. (DMS)	27'-0" Max. Column Base Plate to CL of Top Chord	150 SF < Sign Area ≤ 300 SF Max. Sign Height ≤ 10'-0"		10'-6"W x 6'-0"H Max. 850 Lbs. Max
4-Chord Truss	Standard Design	40'-0" Min. 130'-0" Max.	30'-0" Max. Column Base Plate to CL of Top Chord	300 SF < Sign Area ≤ Note 2 Max. Sign Height ≤ 12'-0"		26'-0"W x 9'-0"H 4,500 Lbs. Max.
4-Chord Truss	Non-Standard Design	>130'-0"	Column Height Exceeds Limit for Standard Design	Sign Area or Height Exceeds Limits For Standard Design		DMS Dimensions or Weight Exceeds Limits For Standard Design

**Table 39.1-3**  
Full Span OSS Selection Criteria

Note 1: The limiting parameters of length, height and sign area are depicted in 39.6 for Contractor Designed OSS and on the Standard Design Drawings for the 4-Chord OSS.

Note 2: Maximum sign area for full span 4-chord standard design = 12' x (90% \* Span Length).



39.1.7 Butterfly and Butterfly Truss OSS

OSS Type	Design	Static Sign Total Area & Max. Dimensions <sup>2</sup>	OR	DMS Total Area & Weight
Butterfly	Standard Design	Sign Area ≤ 200 Sq. Ft. Sign Height ≤ 10'-0"		N.A.
Butterfly Truss <sup>1</sup>	Non-Standard Design	Sign area > 200 sq. ft. Sign Height > 10'-0"		See 4-Chord full span requirements. Limit 2 per structure.

**Table 39.1-4**  
Butterfly and Butterfly Truss OSS Selection Criteria

Note 1: Butterfly Trusses should use the WisDOT 4-chord cantilever truss dimensions (3'-9"W x 5'-0"H). Details similar to the 4-chord cantilever should be used in the design of these structures.

Note 2: The above sign areas are for one side only. Butterfly and Butterfly Truss structures can have double the total sign area listed with back-to-back signs mounted on each side of the structure.

39.1.8 Design Process

The design process for sign structures generally follows the process for bridge structures as detailed in chapter 6. There are some notable exceptions. First, the design of sign structures are usually initiated later in the overall process because they are dependent on a fairly established roadway plan. Second, a certain subset of sign structure types are permitted to be designed and detailed by a contractor, with other types requiring a department structural engineer (in-house or consultant) providing the design and detailing.

As outlined in 11-55-20.3 of the FDM, the Region initiates the sign structure design process by submitting to BOS an SSR. For *Contractor Designed* or *Standard Design* OSS types, as defined in 39.1.3, the Region or their consultant prepare final contract plans and submits via the structure e-submit process at least two months prior to PS&E. BOS must be notified if there are changes to the sign structure type after the SSR is submitted.

Region or consultant staff assemble final contract plans using the lead sheet templates and the *OSS Standard Design Drawings*, available on the BOS [website](#) under the Chapter 39 Bridge Standards - *LRFD Standardized Plans*. See 39.4.4 and 39.4.6 for more information on preparing standardized plans.

Involvement of a Department structural engineer in the design and detailing of individual sign structures is generally limited to *Non-standard* design types. If a Non-standard design is warranted, for reasons detailed in 39.4.5, then the design process follows the normal flow as defined in Chapter 6, requiring either BOS design staff or an engineering consultant provide a unique design and the final contract plans. Non-standard designs should make use of the OSS Standard Design Drawings where appropriate.





39.2 Materials

WisDOT uses the following for round, hollow structural sections (HSS) for truss chord members, vertical support members and horizontal monotube members.

Member Type	Material Requirements	
HSS Chords, Vertical Supports, & Horizontal Monotubes	Wall Thickness ≤ 1/2"	ASTM A500, Grade C (Fy = 46 ksi)
	Wall Thickness > 1/2" and Pipe Diameter ≤ 20"	ASTM A1085 (round HSS) Or API 5L Grade 46 PSL-2 (round pipe)
	Pipe Diameter > 20" (Any Wall Thickness)	API 5L Grade 46 PSL-2 (round pipe)
Plates, Bars, and Structural Angles	ASTM A709, Grade 36	
Round or Multi-Sided Tapered Poles	ASTM A595, Grade A (Fy = 55 ksi) Or ASTM A572, Grade 55	

Galvanized ASTM F3125 A325 bolts with DTI washers are to be used in all primary structural connections, including those that are fully tensioned. A449 bolts are not allowed in fully tensioned connections and are only allowed in full span chord to column saddle or full span post to chord clamp connections. More details can be found in the OSS Standard Design Drawings and Standard Specifications Section 532.

**WisDOT policy item:**

Installation of flat washers in between faying surfaces of mast arm connection plates is not allowed.

When selecting members sizes for individually designed OSS, it is important to select members that are regularly produced and domestically available. Specifying members that are infrequently produced may result in higher bid prices, longer fabrication lead time, and/or member substitution requests that may delay the fabrication and production process. A general rule of thumb is to select HSS round tube members that match standard (Schedule 40) outside pipe diameters and thickness. The Steel Tube Institute provides current information on their website regarding domestic availability of HSS sections at:

<https://steeltubeinstitute.org/hss/availability-tool/>.

Designers can also consult the Bureau of Structures.



### **39.3 Specifications**

#### 39.3.1 LRFD Design

WisDOT has transitioned the design of all roadside standard Type 1 breakaway sign supports and foundations to be in accordance with the *AASHTO LRFD Specifications for Structural Supports for Highway Signs, Luminaries, and Traffic Signals, 1<sup>st</sup> Edition (2015) (LRFDLTS-1)* with current Interim revisions.

WisDOT is currently transitioning the design of OSS to be in accordance with the AASHTO LRFDLTS-1 with current Interim revisions. Use of the AASHTO LRFDLTS-1 specification for OSS is currently optional and will be required beginning with the December 2020 letting.

#### 39.3.2 Other Specifications and Manuals

The following manuals and specifications provide further guidance and requirements for the design and construction of OSS:

- Wisconsin Department of Transportation “*Bridge Manual*” (BM)
- Wisconsin Department of Transportation “*Geotechnical Manual*”
- Wisconsin Department of Transportation “*Facilities Development Manual*” (FDM)
- State of Wisconsin “*Standard Specifications for Highway and Structure Construction*”
- State of Wisconsin “*Construction and Materials Manual*” (CMM)
- AASHTO “*LRFD Bridge Design Specifications*” (Current Edition and Interim Specifications)
- American Society for Testing and Materials Standards (ASTM)
- American National Standards Institute / American Petroleum Institute 5L Specification for Line Pipe. (ANSI / API 5L)
- AWS D1.1 Structural Welding Code (Steel)
- AWS D1.2 Structural Welding Code (Aluminum)



### 39.4 Design Considerations

#### 39.4.1 Roadside Signs

Supports for roadside signs are of two types, depending upon the size and type of the sign to be supported. For small signs, the column supports are treated timber embedded in the ground. For larger Type 1 signs and DMS, the columns are galvanized steel supported on drilled shafts. Standard design and support estimates are given in the A3 Series of the [“Sign Plate Manual.”](#)

Roadside sign supports are located behind existing or planned guardrail as far as practical from the roadway and out of the likely path of an errant vehicle. If roadside signs are located within the 30-foot corridor and not protected, break-away sign supports are detailed. Roadside sign supports for DMS, which includes dynamic message signs and variable message signs, are to be protected by concrete barrier or guardrail.

Currently, all steel column supports for roadside Type 1 signs, and DMS are designed to break-away upon impact.

The Wisconsin DOT Bureau of Traffic Operations has standard designs and details available for Type 1 Roadside Sign supports and foundations. The standard steel post design tables provide maximum sign mounting heights. If a sign configuration is required that does not fall within the limits of the standard designs, the sign support must be designed by a structural engineer. The design must be in compliance with the applicable specifications listed in [39.3](#). The Type 1 roadside sign standard foundation designs are based on the assumptions of cohesionless soils with the following properties:

- Soil Unit Weight = 115 pounds per cubic foot
- Angle of Internal Friction = 24 degrees
- Soil Modulus Parameter = 25 pounds per cubic inch

Wisconsin has standard design and details available for DMS roadside sign supports. If weaker subsurface conditions are known or suspected, a subsurface soil investigation per [39.5](#) would be implemented to gather necessary design information.

#### 39.4.2 Overhead Sign Structures (OSS)

##### 39.4.2.1 General

OSS types and names used by WisDOT are summarized in [Table 39.1-1](#).

The connections of web members to chords are designed for bolted or shop welded connections to allow the contractor the option to either galvanize individual members or complete truss sections after fabrication. Steel base plates are used for anchor rod support attachment.

Aluminum sign structures are currently not being designed for new structures. Rehabilitation and repair type work may require use of aluminum members and shall be allowed in these



limited instances. The following guidelines apply to aluminum structures in the event of repair and rehabilitation type work.

Aluminum sign structure trusses are designed and fabricated from tubular shapes shop welded together in sections. The minimum thickness of truss chords is 1/4-inch and the minimum outside diameter is 4 inches. The recommended minimum ratios of “d/D” between the outside diameter “d” of the web members and “D” of chord members is 0.4. A cast aluminum base plate is required to connect the aluminum columns to the anchor rods. AASHTO Specifications require damping or energy absorbing devices on aluminum overhead sign support structures to prevent vibrations from causing fatigue failures. Damping devices are required before and after the sign panels are erected on all aluminum sign bridges. Stock-bridge type dampers are recommended.

#### 39.4.2.2 Vehicular Protection

Vertical supports for OSS Standard Designs are not designed for vehicular impact loads and must meet clear zone or barrier protection requirements in the FDM. Generally, all overhead sign structure vertical supports are located at the edge of shoulder adjacent to the traveled roadway and placed behind roadside concrete barriers or barrier type guardrail. See the FDM 11-55-20.6 for information on shielding requirements. Sign supports protected by roadside barriers or guardrail with adequate barrier deflection clearance between the backside of the barrier and the sign support are not required to be designed for Extreme Limit State vehicular collision loads.

When protection is not feasible, the vertical supports shall be designed with applicable Extreme Event collision loads in accordance to 13.4.10. This typically requires the use of a special, individually designed reinforced column and foundation to resist the large vehicular impact loads. In this situation the sign structure would be a non-standard design and BOS or an engineering consultant would need to provide the design.

#### 39.4.2.3 Vertical Clearance

As provided in the FDM 11-35-1 Attachment 1.8, a minimum vertical clearance of 18’-3” is required for most routes. For sign structures over a designated High Clearance Route, 20’-3” above the roadway is required. See FDM 11-35-1 Attachment 1.9 for clearances relating to existing sign structures.

#### 39.4.2.4 Lighting and DMS Inspection Catwalks

Lighting is no longer required on sign structures. Catwalks are only on 4-chord cantilever and full span OSS with DMS. When catwalks are provided for OSS supporting a DMS, additional vertical height must be provided to meet the vertical clearance requirements in [39.4.2.3](#) to the bottom of the catwalk brackets. Catwalk grating and toe plates shall be galvanized steel.

Along with inspection catwalks, all DMS OSS require hand holes, rodent screens and electrical conduits through the foundation to one of the vertical support posts to route electric power to the DMS. Standard Details are provided on the BOS website.



### 39.4.2.5 Signs Mounted on the Side of Grade Separation Bridges

When no practical alternatives exist, signs may be mounted on the side of grade separation bridges. This application requires individually designed structural mounting brackets to attach the sign to the side of the grade separation bridge. Wisconsin allows sign attachments orientated up to a maximum of a 20-degree skew to the roadway below. Any grade separation bridge structure with greater skew requires the mounting brackets to attach signs so they are orientated perpendicular to the roadway below.

Where possible, the depth of bridge mounted signs should be limited so the top of the sign does not extend above the top of the bridge parapets or railing. Signs are not permitted to extend below the bottom of the bridge girders. The minimum vertical clearance is set slightly above the clearance line of the overpass structure for signs attached directly to the side of a bridge.

Signs attached to the side of bridge superstructures and retaining walls are difficult to inspect and maintain due to lack of access. Attachment accessories are susceptible to deterioration from de-icing chemicals, debris collection and moisture. Therefore, the following guidance should be considered when detailing structure mounted signs and related connections:

1. Limit the sign depth to a dimension equal to the bridge superstructure depth (including parapet) minus 3 inches.
2. Provide at least two support connections per bracket.
3. Utilize cast-in-place anchor assemblies to attach sign supports onto new bridges and retaining walls.
4. Galvanized or stainless-steel adhesive concrete masonry anchor may be used to attach new signs to the side of an existing grade separation bridge or retaining wall orientated for shear load application only. Overhead anchor installation (direct pullout loading on anchor) is not allowed. Reference 40.16 for applicable concrete masonry anchor requirements.

### 39.4.2.6 Sign Structures Mounted on Bridge Pedestals

This refers to sign structures mounted across the top of roadways carried by a bridge structure. Sign structures can be mounted directly to the top of pier caps. This requires the pier cap to be extended beyond the limits of the superstructure width. Sign structures mounted to pier caps are not affected by superstructure deflections. Wisconsin allows sign attachments orientated up to a maximum of a 20-degree skew to the roadway below. Any grade separation bridge structure with a greater skew requires the mounting brackets to attach signs so they are oriented perpendicular to the roadway below.

Span live load deflections of the vehicular bridge superstructure affect sign structures mounted on to bridge superstructure concrete barrier pedestals. The magnitude of sign structure deflections and duration of sign structure vibrations is dependent on the stiffness of the girder and deck superstructure, the location of the sign structure on the bridge, and



the ability of the sign structure to dampen those vibrations out; among others. These vibrations are not easily accounted for in design and are quite variable in nature. For these reasons, the practice of locating sign structures on highway bridges should be avoided whenever possible.

The following general guidance is given for those instances where locating a sign structure on a bridge structure is unavoidable. This may occur due to the length of the bridge, or a safety need to guide the traveling public to upcoming ramp exits or into specific lanes on the bridge.

1. Locate the sign structure pedestals at pier locations.
2. Build the sign structure base off the top of the pier cap.
3. Provide adequate set back of the tower support of the sign structure behind the face of the parapet to avoid snagging of vehicles making contact with the parapet. See FDM 11-45-2.3.6.2.3 for information on required set back distances.
4. Use single pole sign supports (equal balanced butterfly's) in lieu of cantilevered (with an arm on only one side of the vertical support) sign supports.
5. Consider the use of a Stockbridge type damper in the horizontal truss of these structures.
6. Do not straddle the pier leaving one support on the pier and one support off the pier in the case of skewed substructure units for full span sign bridges

### 39.4.3 LRFD Requirements and WisDOT Guidance for OSS Design

#### 39.4.3.1 Loads, Load Combinations, and Limit States

All OSS are to be designed per the AASHTO LRFDLTS-1. The following LRFD specification requirements are highlighted:

Design Wind Speed Recurrence Interval:

- Full Span 4-Chord Truss and median Butterfly Sign Structures are designed for a basic wind speed recurrence interval of 1,700 years as defined in the AASHTO LRFDLTS-1 Specifications.
- All other OSS shall be designed for a basic wind speed recurrence interval of 700 years as defined in the AASHTO LRFDLTS-1 Specifications.

Wind load and wind load combinations shall be applied and investigated per AASHTO LRFDLTS-1. In general, horizontal wind pressure is applied normal to the center of gravity of exposed horizontal members and sign panels. For the design of vertical supports, three wind load cases are investigated and applied to the entire structure to determine the controlling wind load effect on the vertical supports:



Wind Load Case	Description	Normal Wind Component	Transverse Wind Component
1	Full Wind Normal to the Plane of the Structure	100%	0%
2	Full Wind Transverse to the Plane of the Structure	0%	100%
3	75% Full Wind in Both Directions Simultaneously	75%	75%

**Figure 39.4-1**  
AASHTO LRFDLTS-1 Vertical Support Load Cases

Design sign area assumed for standard designs accommodates 12-foot high sign panels over 90% of the span length for full span 4-chord truss OSS. In the case of a proposed non-standard OSS with a required span length of 130 feet or less, the non-standard OSS should be individually designed for the actual anticipated sign panel area or DMS and mounting locations. In the case of a proposed non-standard OSS with required span length greater than 130 feet, the Bureau of Structures should be consulted to confirm the design sign area to be used for the design of the non-standard OSS.

Applied design wind pressure is determined for individual truss members and sign panels per the AASHTO LRFDLTS-1 specification Section 3.8. WisDOT design practice is to assume members located directly behind sign or DMS panels are shielded from wind exposure and are not loaded with wind pressure. No wind shielding is assumed provided to members that directly align with each other in plan or elevation views, but are several feet apart. This means no shielding effect is assumed for members in the front and back truss planes of a 4-chord truss even if the members are perfectly aligned. For example, viewing a 4-chord truss in elevation view, members in the front truss plane, located directly behind a sign panel would be assumed to be shielded from wind pressure by the sign panel, but members in the back-truss plane would be assumed to be loaded with wind pressure, despite also being behind the sign panel or aligned with other members in the front truss plane.

Strength 1 load combinations in AASHTO LRFDLTS-1 include only dead load and live load. A 500-pound live load distributed over 2'-0" transversely to the member, only applies to catwalks and catwalk support brackets when catwalks are included for OSS with DMS. The Strength 1 load combination may control the design of the catwalk and catwalk support brackets, but does not control the design of the truss superstructure the catwalk brackets are attached to. For OSS carrying static Type 1 signs, the Strength I load combination includes only dead load and does not control.

Load combinations that include wind generally control the design of sign structures. A change in the AASHTO LRFDLTS-1 specification is that load combinations that include wind are considered Extreme Event load cases.

AASHTO LRFDLTS-1 specifications do not define an ice loading and leave it to the discretion of individual owners to consider and specify an ice loading if warranted in their climate. WisDOT policy is to maintain consideration of an ice load and include in the Extreme Event I load combination.

Load Combinations are as follows:





- Strength I: 1.25 DL + 1.6 LL
- Extreme Event I (Load Case 1): 1.1 DL + 1.0 ICE + W (Max. DL and ICE effects)
- Extreme Event I (Load Case 2): 0.9 DL + W (Min. DL and no ICE effects)

Ice build-up is modeled as a 3 psf load applied to the exposed surface area (circumference) of truss members. It is not necessary to increase the wind pressure load on truss members due to increased member exposure area caused by ice build-up. Ice load is applied to only the front face of sign or DMS panels.

For vertical column support members, W in the above Extreme Event load cases is the controlling wind load case as specified in [Figure 39.4-1](#).

### 39.4.3.2 Serviceability

Serviceability checks should conform to 10.4 and 10.5 of AASHTO LRFDLTS-1. However, the vertical deflection limit  $L/150$  shall include ICE load, applied per 39.4.3.1.

### 39.4.3.3 Fatigue

AASHTO LRFDLTS-1 specifies three fatigue loads to check against member and connection fatigue stress range limits as follows:

- Galloping – AASHTO LRFDLTS 11.7.1.1: Applies to all cantilever OSS, except cantilever 4-chord truss
- Natural Wind Gust – AASHTO LRFDLTS 11.7.1.2: Applies to all OSS.
- Truck Induced Gust – AASHTO LRFDLTS 11.7.1.3: Applies to all OSS.

Truck induced gust pressure is applied in the upward direction and reduces with increasing height. Truck induced gust pressure applied to truss members in the top horizontal truss plane, will be less than truck induced gust pressures applied to truss members in the bottom horizontal truss plane. Since truck induced gust pressure is acting upward, Type 1 static signs receive and transmit only minimal gust pressure due to their narrow profile when viewed in plan. DMS however, have considerable width and “wind exposure area” when viewed in plan. Truck induced gust pressure can impart a significant upward pressure on DMS that also creates a torque on the truss superstructure due to the offset between the center of gravity of the DMS and the truss superstructure.

### 39.4.3.4 Connection Design

**WisDOT policy item:**

Bureau of Structures policy is to design welded and bolted connections per the applicable provisions of the current AASHTO LRFD Bridge Design Specifications. This is a deviation from the AASHTO LRFDLTS-1, which refer the design of welded connections to the AWS D1.1 Structural Welding Code.





For truss superstructures, current practice is to design and provide alternate details of the connection of web members (angles) to main chord members (HSS tubular round sections) for both welded and bolted connections, except the chord to column connection and first panel of cantilever trusses which must be bolted. This affords the fabricator the option of galvanizing individual members prior to truss fabrication (using bolted connections) or galvanizing entire truss segments after assembly (using bolted or welded connections).

#### 39.4.4 OSS Standard Designs

Standard Design OSS types and limitations are listed in [Table 39.1-2](#) and [Table 39.1-3](#). Because these structures are pre-designed and pre-detailed the involvement of a Department structural engineer is usually not required. Bureau of Structures is responsible for maintaining and updating the Standard Designs as needed.

The Standard Design OSS types were developed to cover a wide range of signage requirements while placed over typical roadway and roadside configurations. Standard Designs are not intended to cover unique situations or unusual geometry, or for reasons described in 39.4.5. Contact the Bureau of Structures Design Section with questions regarding applicability of standard designs.

Standard Foundation Designs are included in the OSS Standard Detail Drawings. See [39.5](#) for further guidance on subsurface investigation, assumed soil parameters, and foundation design.

When Standard Design OSS are used in a project, the Region or their consultant prepare final contract plans as described in [39.1.9](#). This includes filling out the appropriate sign structure specific information on both the General Notes and General Layout sheets and combining those with the appropriate OSS Standard Design Drawings to make up the final plan set.

#### 39.4.5 OSS Non-Standard Designs

Design and plan detailing must be provided by Bureau of Structures or by a structural design consultant for all non-standard designs. The following circumstances warrant a non-standard design:

1. The OSS type is Butterfly Truss or Bridge Mounted
2. The OSS type falls outside the limits of span length, sign area, DMS weight, or sign height in FDM 11-55-20 Figure 20.2.3 and Figure 20.2.4.
3. Region soil engineer advises that subsurface conditions at the site are expected to negatively differ from assumed soil profile and design parameters of standard foundations (e.g. soft soil or shallow bedrock – see [39.5.2.2](#)).
4. Excessive sign structure height (e.g. sign structure behind MSE wall) or requires the use of concrete column (designed for impact load – see [39.4.2.2](#))



BOS must be consulted to verify and confirm the need for individual designs before undertaking this effort.

The design detailing shall generally follow the guidance provided by the OSS Standard Design Drawings but should clearly delineate any required changes to individual member sizes, connections and foundation details necessary to satisfy the AASHTO LRFDLTS-1 Design Specifications.

In some instances, it may still be appropriate to use part or all of the Standard Designs even though the sign structure is considered a Non-standard Design. A couple of examples include:

1. A sign structure has both static and DMS sign types specified for mounting (consult with BOS before using a standard design in this situation).
2. A Standard Design structure is used in conjunction with a Non-standard foundation. See section [39.5.3](#).

In any case, the sign structure is still considered a Non-standard design in terms of the design process and should proceed as detailed in [39.1.9](#).

#### 39.4.6 OSS Contractor Designed

Contractor Designed OSS types and limitations are listed in [Table 39.1-2](#) and [Table 39.1-3](#). Because these structures are designed by the contractor, involvement of a Department structural engineer is usually not required.

Standard Foundation Designs are included in the OSS Standard Detail Drawings. The standard foundations only include the design of the drilled shaft, the contractor is responsible for designing the anchor rods and superstructure. See [39.5](#) for further guidance on subsurface investigation, assumed soil parameters, and foundation design. Bureau of Structures is responsible for maintaining and updating the standard foundation designs that go along with the Contractor Designed OSS types.

These structures are designed for the required actual sign area and configuration, unless future expansion is anticipated, which should be noted and shown on the plans. The required actual sign area, span length, etc. is used to select the appropriate standard foundation from the figure provided in chapter 11-55-20 of the FDM.

When Contractor Designed OSS are used in a project, the Region or their consultant prepare final contract plans as described in [39.1.9](#). This includes filling out the appropriate sign structure specific information on both the General Notes and General Layout sheets and combining those with the appropriate OSS Standard Design Drawings to make up the final plan set.



### **39.5 Geotechnical Guidelines**

#### **39.5.1 General**

For butterfly structures and 4-chord trusses, the typical preferred foundation is comprised of two cylindrical drilled shafts connected by a concrete cross-girder, as detailed in the OSS Standard Design Drawings. The top of the cross-girder is set 3 feet above the highest ground elevation at the foundation. For all other types, the typical preferred foundation is comprised of a single cylindrical drilled shaft directly supporting the column vertical support. Occasionally, some columns are mounted directly on top of modified bridge parapets, pier caps and concrete towers instead of footings.

There are several potential challenges regarding subsurface exploration for OSS foundations:

- The development and location of these structures are typically not known at the onset of the preliminary design stage, when the most subsurface exploration typically occurs. This creates the potential need for multiple drilling mobilizations for the project.
- OSS are often located in areas of proposed fill soils. The source and characteristics of fill soil is unknown at the time of design.
- OSS foundations are often located on the shoulder or median directly adjacent to high-volume roadways. Obtaining boings in these locations typically requires significant traffic control, night work, and working in a potentially hazardous work zone.
- If a consultant is involved in the project, the unknowns associated with these structures in the project scoping stage complicate the consultant contracting process. It is often difficult to determine the need for OSS specific subsurface investigation at the time the consultant contract is normally being scoped. In cases where the need for a specific subsurface investigation is known or anticipated, an assumption must be made regarding the level of subsurface investigation to include in the consultant design contract. Alternatively, a decision can be made to assume use of standard OSS and foundation designs. If the need for specific subsurface investigation is later determined to be necessary, this may require a change to add it to the consultant contract.

#### **39.5.2 Standard Foundations for OSS**

##### **39.5.2.1 General**

WisDOT has created standard full span and cantilever 4-chord truss designs that include fully designed and detailed drilled shaft foundations as part of the overall standard design. The standard foundation details are incorporated with the OSS Standard Design Drawings for these structures and are available on the BOS website.

Single drilled shaft OSS Standard Design Drawings for use with contractor designed full span and cantilever 2-chord truss and monotube OSS are also available on the BOS website.



WisDOT has no standard foundation design details for alternate foundation types and the selected alternative foundations would be required to be individually designed and reviewed by BOS.

### 39.5.2.2 Design Parameters Used for Standard Foundation Design

Standard dual and single drilled shaft foundation designs were developed in accordance with applicable requirements of Section 10 of the *AASHTO LRFD Bridge Design Specifications*.

The standard foundation designs are based on the following design parameters:

- Total Unit Weight = 125 pcf
- Granular Soil Profile: Internal Angle of Friction = 24 degrees, or
- Cohesive Soil Profile: Undrained Shear Strength = 750 psf
- Soil and drilled shaft downward resistance factor  $\phi = 1.0$ <sup>1</sup>
- Drilled shaft uplift resistance factor  $\phi = 0.8$ <sup>1</sup>
- Depth of water table assumed 10 feet below the ground surface
- Soil side resistance is considered fully effective to the top of the drilled shaft or top of ground surface, whichever is the lower elevation.
- Lateral deflection at the top of the foundation limited to 1-inch at the Service I Limit State

Note 1: Resistance factors per AASHTO 10.5.3.3 assuming the drilled shaft design is governed by the wind load combination which is an Extreme Event load combination.

**WisDOT policy item:**

Design of standard sign structure foundations assumes soil side resistance is fully effective to the top of the drilled shafts for full span 4-chord OSS foundations and to within 3 feet below the lowest ground surface for all other OSS foundations. This is a deviation from AASHTO 10.8.3.5 1b.

Use of the standard foundations requires that the in-situ soils parameters at the site meet or exceed the assumed soil design parameters noted above. Soil parameters were selected to be sufficiently conservative to cover most sites across the state. Designers should contact the Region Soils Engineer or the Geotechnical Consultant to assist in the evaluation of the subsurface conditions compared to the assumed soil parameters. An assessment can also be made by checking nearby borings and as-built drawings of nearby existing structures, and similar sources. If there is reason to suspect weaker soils or that shallow bedrock is present, OSS specific soil borings should be obtained to confirm in-situ soil properties meet or exceed the assumed parameters used for the standard designs. If these site-specific soil properties



do not meet the above minimums, a special individual foundation design will be required using actual soil parameters determined from a subsurface investigation per [39.5.3](#).

### 39.5.3 Standard Base Reactions for Non-Standard Foundation Design

There may be instances when a Standard Design sign structure is used in conjunction with a non-standard foundation, for reasons detailed in [39.4.5](#). Contact Bureau of Structures to obtain the Standard Design or Contractor Designed sign structure base reactions that were used in developing the standard foundations.

### 39.5.4 Subsurface Investigation and Information

No subsurface investigation/information is necessary for the use of WisDOT standard foundations. Appropriate subsurface information is necessary for any non-standard OSS or situation that is outside any of the standard design ranges of applicability which requires an individual foundation design to be performed.

There may be several methods to obtain the necessary subsurface soil properties for a custom, individual foundation design, as described below:

- In areas of fill soils, the borrow material is usually unknown. The designer should use their best judgment as to what the imported soils will be. Standard compaction of this material can be assumed.
- The designer may have a thorough knowledge of the general soil conditions and properties at the site and can reasonably estimate soil design parameters.
- The designer may be able to use information from nearby borings. Judgment is needed to determine if the conditions present in an adjacent boring(s) are representative of those of the site in question.
- If the designer cannot reasonably characterize the subsurface conditions by the above methods, a soil boring and Geotechnical report (Site Investigation Report) should be completed. Necessary soil design information includes soil unit weights, cohesions, phi-angles and location of water table.

Designers, both internal and consultant, should also be aware of the potential of high bedrock, rock fills and the possible conflict with utilities and utility trenches. Conservative subsurface design parameters are encouraged.

39.6 Appendix – OSS Limiting Parameters

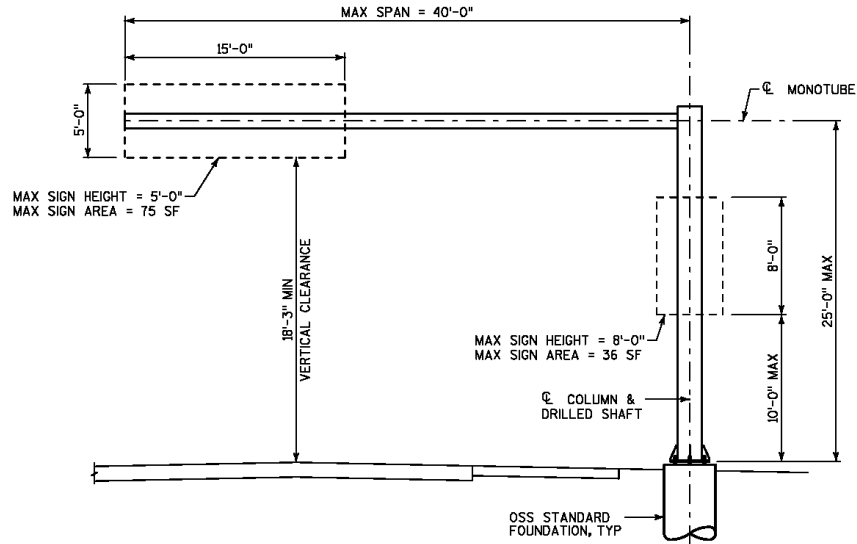

**CANTILEVER MONOTUBE**

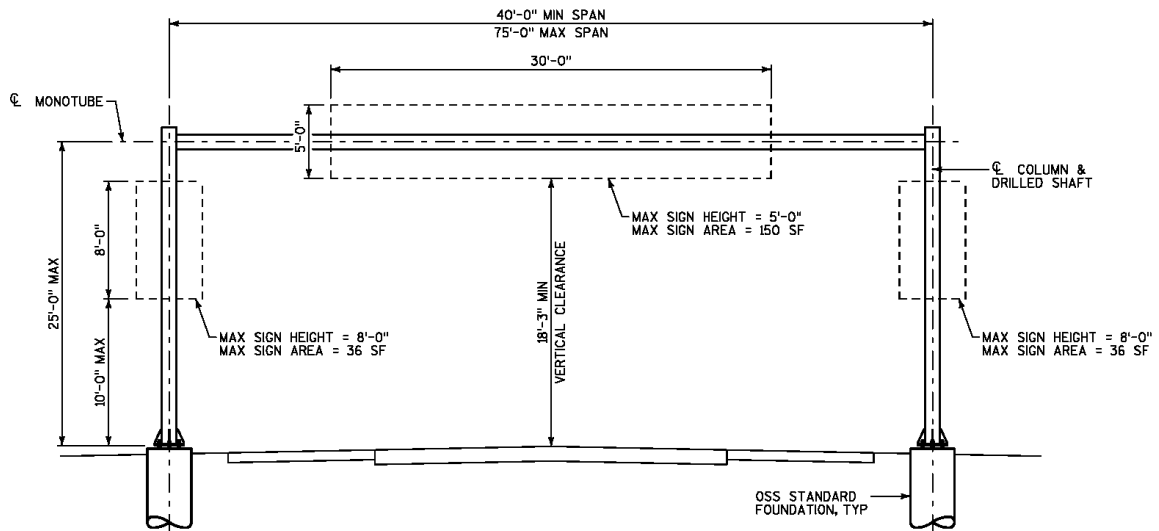

**FULL SPAN MONOTUBE**

**DESIGNER NOTES:**

1. SELECT STRUCTURE TYPE BASED ON REQUIRED SPAN LENGTH AND DESIGN SIGN AREA TO BE SUPPORTED ON THE STRUCTURE. SHOW ON THE "GENERAL LAYOUT" SHEET FOR THE STRUCTURE.
2. SELECT OSS STANDARD FOUNDATION TYPE AND SHOW ON THE "GENERAL LAYOUT" SHEET. SEE "OSS MONOTUBE & 2-CHORD TRUSS STANDARD FOUNDATIONS" SHEET AND SECTION II-55-20 OF THE WISDOT FACILITIES DEVELOPMENT MANUAL FOR FOUNDATION SELECTION CRITERIA.
3. COLUMN SIGN AREA DOES NOT CONTRIBUTE TO THE SELECTION LIMITS OF THE FDM, BUT ARE PERMITTED UP TO THE LIMITS SHOWN IN THE FIGURES.

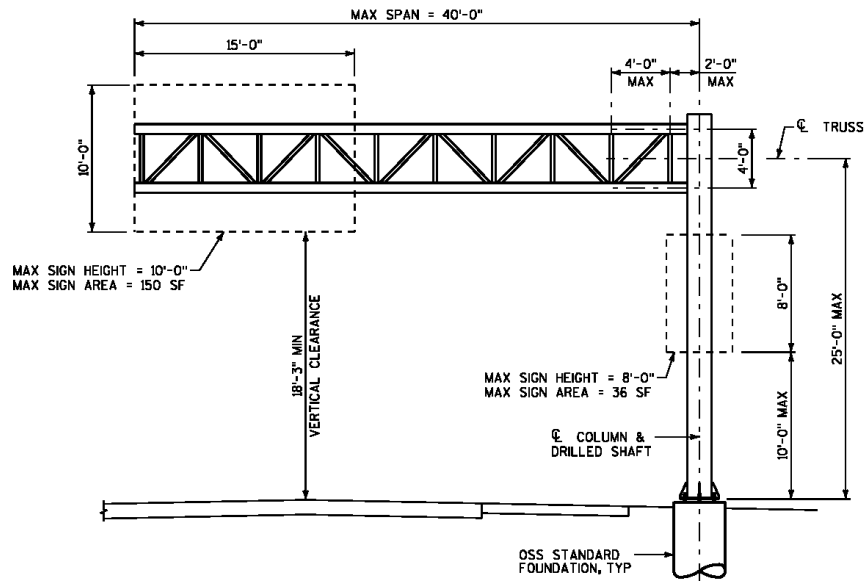

**CANTILEVER 2-CHORD TRUSS**

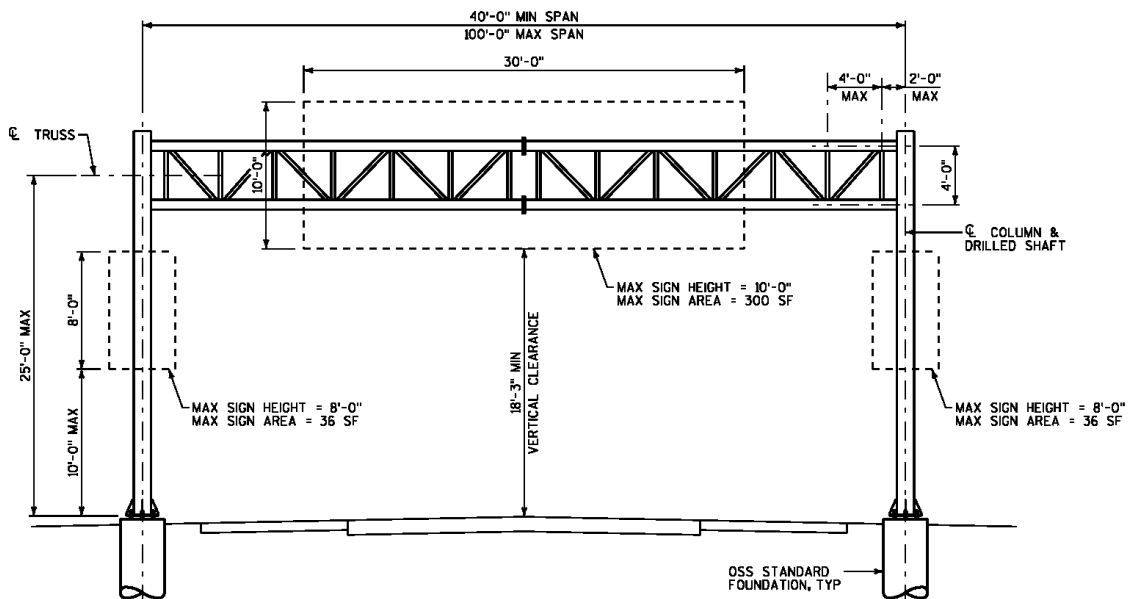

**FULL SPAN 2-CHORD TRUSS**

**DESIGNER NOTES:**

1. SELECT STRUCTURE TYPE BASED ON REQUIRED SPAN LENGTH AND DESIGN SIGN AREA TO BE SUPPORTED ON THE STRUCTURE. SHOW ON THE "GENERAL LAYOUT" SHEET FOR THE STRUCTURE.
2. SELECT OSS STANDARD FOUNDATION TYPE AND SHOW ON THE "GENERAL LAYOUT" SHEET. SEE "OSS MONOTUBE & 2-CHORD TRUSS STANDARD FOUNDATIONS" SHEET AND SECTION II-55-20 OF THE WISDOT FACILITIES DEVELOPMENT MANUAL FOR FOUNDATION SELECTION CRITERIA.
3. COLUMN SIGN AREA DOES NOT CONTRIBUTE TO THE SELECTION LIMITS OF THE FDM, BUT ARE PERMITTED UP TO THE LIMITS SHOWN IN THE FIGURES.

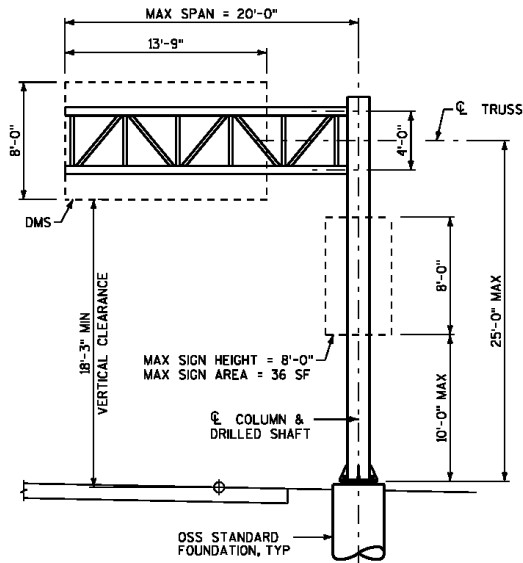

**CANTILEVER 2-CHORD TRUSS DMS**

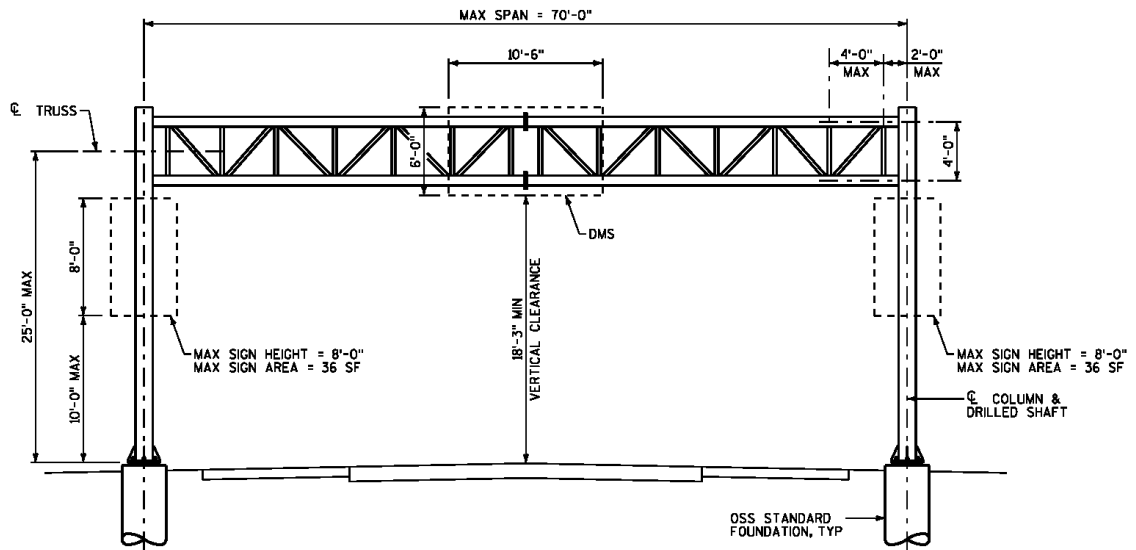

**FULL SPAN 2-CHORD TRUSS DMS**

**DESIGNER NOTES:**

1. SELECT STRUCTURE TYPE BASED ON REQUIRED SPAN LENGTH AND DESIGN SIGN AREA TO BE SUPPORTED ON THE STRUCTURE. SHOW ON THE "GENERAL LAYOUT" SHEET FOR THE STRUCTURE.
2. SELECT OSS STANDARD FOUNDATION TYPE AND SHOW ON THE "GENERAL LAYOUT" SHEET. SEE "OSS MONOTUBE & 2-CHORD TRUSS STANDARD FOUNDATIONS" SHEET AND SECTION II-55-20 OF THE WISDOT FACILITIES DEVELOPMENT MANUAL FOR FOUNDATION SELECTION CRITERIA.
3. COLUMN SIGN AREA DOES NOT CONTRIBUTE TO THE SELECTION LIMITS OF THE FDM, BUT ARE PERMITTED UP TO THE LIMITS SHOWN IN THE FIGURES.





**39.7 Design Examples**

- E39-1 Design of Foundation Cap Beam / Integral Barrier TL-5 Loading
- E39-2 Design of Sign Bridge Concrete Column for Vehicle Impact



This page intentionally left blank.



Table of Contents

E39-1 Design of Foundation Cap Beam / Integral Barrier - TL-5 Loading . . . . .	2
E39-1.1 Design Criteria . . . . .	3
E39-1.2 Design Forces for Traffic Railings . . . . .	3
E39-1.3 Loads . . . . .	4
E39-1.4 Limit States and Combinations . . . . .	4
E39-1.5 Analysis Case I . . . . .	4
E39-1.6 Analysis Case II . . . . .	5
E39-1.7 Flexural Strength Capacity . . . . .	6
E39-1.8 Shear Capacity . . . . .	8
E39-1.9 Check Reinforcement at Top of Drilled Shaft . . . . .	11
E39-1.10 Interface Shear Transfer . . . . .	13



**E39-1 Design of Foundation Cap Beam / Integral Barrier - TL-5 Loading**

This example shows design calculations for a four chord sign bridge foundation cap beam supported on two drilled shafts that is integral with a roadway barrier. The AASHTO LRFD Bridge Design Specifications 8th Edition - 2017 are followed for the cap beam design using a TL-5 design force for traffic railings.

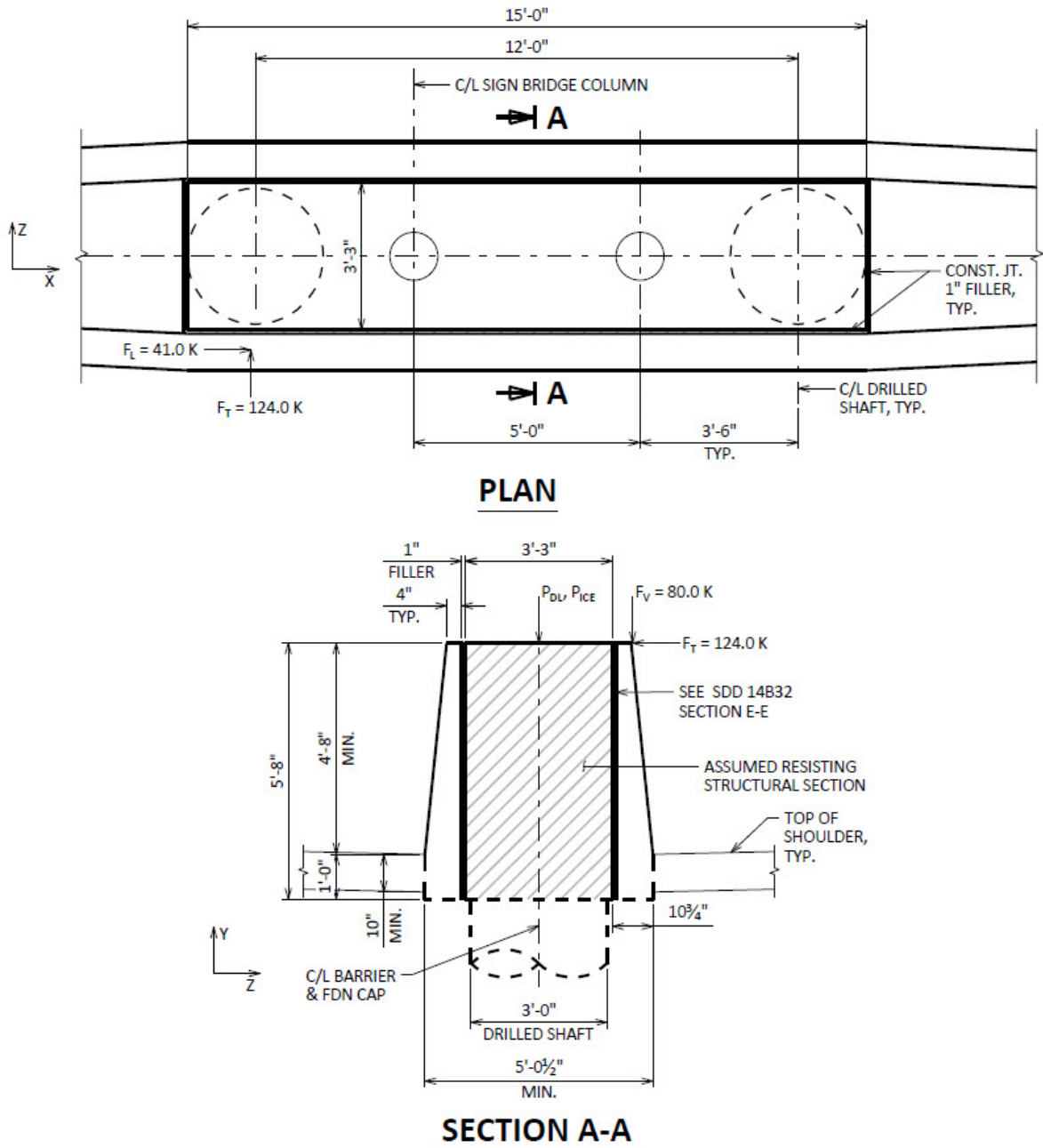



E39-1.1 Design Criteria

Cap/Integral Barrier Material Properties

$f'_c := 3.5 \text{ ksi}$	Concrete Strength
$f_y := 60 \text{ ksi}$	Yield Strength of Reinforcement
$E_s := 29000 \text{ ksi}$	Modulus of elasticity of steel
$w_c := 0.150 \text{ kcf}$	Unit Weight of concrete

Barrier and Foundation Geometry

$H_{barrier} := 66.00 \text{ in}$	Height of Barrier
$H_{barrier\_vert} := 10.00 \text{ in}$	Height of Barrier Vertical Section
$W_{barrier\_top} := 49.00 \text{ in}$	Width of Barrier at Top
$W_{barrier\_bott} := 60.5 \text{ in}$	Width of Barrier at Bottom
$W_{barrier\_str} := 39.00 \text{ in}$	Width of Barrier Structural Section
$L_{barrier} := 15.00 \text{ ft}$	Length of Barrier Section
$Diam_{shaft} := 3.00 \text{ ft}$	Diameter of Drilled Shaft
$Shaft\_Spa := 12.00 \text{ ft}$	Spacing Between Drilled Shafts

E39-1.2 Design Forces for Traffic Railings

From **LRFD Table A13.2-1**, use Test Level Five (TL-5) design forces for integral barrier/cap check. Forces are conservatively applied as point loads instead of being distributed longitudinally along the integral barrier/cap foundation length.

$F_t := 124.0 \text{ kips}$	Transverse design load
$F_L := 41.0 \text{ kips}$	Longitudinal design load
$F_v := 80.0 \text{ kips}$	Vertical design load (down)
$H_e := 56.0 \text{ in}$	Minimum height of transverse design load = 42". Apply transverse load at top of barrier.



E39-1.3 Loads

Barrier/Cap Uniform Dead Load

Note - Uniform Dead Load is for the full area of the integral barrier including portions of the barrier outside the structural section.

$$H_{\text{barrier\_slope}} := H_{\text{barrier}} - H_{\text{barrier\_vert}} \qquad H_{\text{barrier\_slope}} = 56.00 \text{ in}$$

$$\text{Area}_{\text{barrier}} := \left( H_{\text{barrier\_slope}} \cdot \text{mean} (W_{\text{barrier\_top}}, W_{\text{barrier\_bott}}) \downarrow + H_{\text{barrier\_vert}} \cdot W_{\text{barrier\_bott}} \right) \cdot \frac{1}{144}$$

$$\text{Area}_{\text{barrier}} = 25.493 \text{ ft}^2$$

$$W_{DC} := \text{Area}_{\text{barrier}} \cdot w_c \qquad W_{DC} = 3.824 \text{ kips/ft}$$

Sign Structure Dead and Ice Loads - bottom of column reaction taken from SAP2000 analysis for an 82 ft span sign bridge with 30 ft column height.

$$P_{dl} := 8.05 \text{ kips} \qquad P_{ice} := 3.34 \text{ kips}$$

Barrier Live Load - There is no live load on the barrier since there is no live load on the sign structure.

E39-1.4 Limit States and Combinations

Limit State Extreme Event II for vehicle collision shall be applied using the following equation and load factors from **LRFD Table 3.4.1-1 & Table 3.4.1-4**.

$$M_u := 1.0 \cdot DC + 0.5 \cdot LL + 1.0 \cdot IC + 1.0 \cdot CT$$

E39-1.5 Analysis Case I

Maximize moments in integral barrier/foundation cap by placing TL-5 loads at midspan between the drilled shafts. Assume barrier is a simply supported span between the centerlines of the drilled shafts.

Moments due to transverse forces:

$$M_{y\_DC} := 0.0 \qquad M_{y\_LL} := 0.0 \qquad M_{y\_IC} := 0.0$$

$$M_{y\_CT} := F_t \cdot \frac{(L_{\text{barrier}} - \text{Diam}_{\text{shaft}})}{4} \qquad M_{y\_CT} = 372.0 \text{ ft} \cdot \text{kips}$$

$$M_{uy} := 1.0 \cdot M_{y\_DC} + 0.5 \cdot M_{y\_LL} + 1.0 \cdot M_{y\_IC} + 1.0 \cdot M_{y\_CT} \qquad M_{uy} = 372.0 \text{ ft} \cdot \text{kips}$$

Moments due to vertical forces:



$CL_{col\_shaft} := 4.25 \text{ ft}$  Distance from CL drilled shaft to center of cap.

$$M_{z\_DC} := \frac{W_{DC} \cdot (Shaft\_Spa)^2}{8} + \frac{P_{dl}}{2} \cdot CL_{col\_shaft} \quad M_{z\_DC} = 85.9 \text{ kip} \cdot \text{ft}$$

$$M_{z\_IC} := \frac{P_{ice}}{2} \cdot CL_{col\_shaft} \quad M_{z\_IC} = 7.1 \text{ kip} \cdot \text{ft}$$

$$M_{z\_LL} := 0.0 \quad M_{z\_LL} = 0 \text{ kip} \cdot \text{ft}$$

$$M_{z\_CT} := \frac{F_v \cdot Shaft\_Spa}{4} \quad M_{z\_CT} = 240.0 \text{ kip} \cdot \text{ft}$$

$$M_{uz} := 1.0 \cdot M_{z\_DC} + 0.5 \cdot M_{z\_LL} + 1.0 \cdot M_{z\_IC} + 1.0 \cdot M_{z\_CT} \quad M_{uz} = 333.0 \text{ kip} \cdot \text{ft}$$

### E39-1.6 Analysis Case II

Maximize shears in integral barrier/foundation cap by placing TL-5 loads at centerline of drilled shaft. Assume shear is resisted by a single shaft (conservative).

Shears due to transverse forces:

$$V_{z\_DC} := 0.0$$

$$V_{z\_LL} := 0.0$$

$$V_{z\_IC} := 0$$

$$V_{z\_CT} := F_t \quad V_{z\_CT} = 124.0 \text{ kips}$$

$$V_{uz} := 1.0 \cdot V_{z\_DC} + 0.5 \cdot V_{z\_LL} + 1.0 \cdot V_{z\_IC} + 1.0 \cdot V_{z\_CT} \quad V_{uz} = 124.0 \text{ kips}$$

Shears due to vertical forces:

$$V_{y\_DC} := P_{dl} + W_{DC} \cdot \frac{L_{barrier}}{2} \quad V_{y\_DC} = 36.73 \text{ kips}$$

$$V_{y\_IC} := P_{ice} \quad V_{y\_IC} = 3.34 \text{ kips}$$

$$V_{y\_LL} := 0.0$$

$$V_{y\_CT} := F_v \quad V_{y\_CT} = 80.00 \text{ kips}$$

$$V_{uy} := 1.0 \cdot V_{y\_DC} + 0.5 \cdot V_{y\_LL} + 1.0 \cdot V_{y\_IC} + 1.0 \cdot V_{y\_CT} \quad V_{uy} = 120.07 \text{ kips}$$



E39-1.7 Flexural Strength Capacity

For rectangular section behavior (vertical loading):

$$c := \frac{A_s \cdot f_y}{\alpha_1 \cdot f'_c \cdot \beta_1 \cdot b}$$

LRFD [5.6.2.2]

$$\alpha_1 := 0.85$$

(for  $f'_c < 10.0 \cdot \text{ksi}$ )

$$\beta := \begin{cases} \text{if } f'_c \leq 3.5 \\ \quad \parallel \\ \quad \parallel 0.85 \\ \quad \parallel \\ \text{else} \\ \quad \parallel \\ \quad \parallel 0.85 - (f'_c - 4) \cdot 0.05 \\ \quad \parallel \end{cases}$$

$$\beta_1 := \max(\beta, 0.65)$$

$$\beta_1 = 0.85$$

$$b := W_{\text{barrier\_str}}$$

$$b = 39.00 \text{ in}$$

The 82 ft. span sign bridge with 30 ft. column height standard foundation cap provides #6 bars for bottom reinforcement and #6 bar stirrups. For the vehicular collision force, which is an extreme limit event state not included in the standard foundation cap designs, it is necessary to increase the bottom reinforcement to at least 7 - #7 bars:

$$A_{st\_7} := 0.60 \text{ in}^2$$

$$Num\_bars := 7$$

$$A_s := A_{st\_7} \cdot Num\_bars$$

$$A_s = 4.20 \text{ in}^2$$

$$c := \frac{A_s \cdot f_y}{\alpha_1 \cdot f'_c \cdot \beta_1 \cdot b}$$

$$c = 2.56 \text{ in}$$

$$a := \beta_1 \cdot c$$

$$a = 2.17 \text{ in}$$

$$Clr\_cov := 3.00 \text{ in}$$

Bottom bar clear cover

$$dia_7 := 0.875 \text{ in}$$

Diameter bottom bars

$$dia_6 := 0.75 \text{ in}$$

Diameter stirrup bars

$$d_{\text{vert}} := H_{\text{barrier}} - Clr\_cov - dia_6 - 0.5 \cdot dia_7$$

$$d_{\text{vert}} = 61.81 \text{ in}$$

$$M_{nz} := A_s \cdot f_y \cdot \left( d_{\text{vert}} - \frac{a}{2} \right) \cdot \frac{1}{12}$$

$$M_{nz} = 1275.3 \text{ kip} \cdot \text{ft}$$





For reinforced concrete sections:

$\phi_f := 0.9$  LRFD [5.5.4.2]. Therefore, the factored flexural resistance is:

$$M_{rz} := \phi_f \cdot M_{nz} \qquad M_{rz} = 1147.7 \text{ kip} \cdot \text{ft}$$

For rectangular section behavior (transverse loading):

$$b := H_{\text{barrier}} \qquad b = 66.00 \text{ in}$$

Assume side reinforcement is #6 bars and stirrups are #6 bars:

$$A_{st\_6} := 0.44 \text{ in}^2 \qquad \text{Num\_bars} := 8$$

$$A_s := A_{st\_6} \cdot \text{Num\_bars} \qquad A_s = 3.52 \text{ in}$$

$$c := \frac{A_s \cdot f_y}{\alpha_1 \cdot f'_c \cdot \beta_1 \cdot b} \qquad c = 1.27 \text{ in}$$

$$a := \beta_1 \cdot c \qquad a = 1.08 \text{ in}$$

$$\text{Clr\_cov} := 2.00 \text{ in} \qquad \text{Side bar clear cover}$$

$$\text{dia}_6 := 0.75 \text{ in} \qquad \text{Diameter of stirrup/side bars}$$

$$d_{\text{horiz}} := W_{\text{barrier\_str}} - \text{Clr\_cov} - \text{dia}_6 - 0.5 \cdot \text{dia}_6 \qquad d_{\text{horiz}} = 35.88 \text{ in}$$

$$M_{ny} := A_s \cdot f_y \cdot \left( d_{\text{horiz}} - \frac{a}{2} \right) \cdot \frac{1}{12} = 621.934 \qquad M_{ny} = 621.9 \text{ kip} \cdot \text{ft}$$

For reinforced concrete sections:

$\phi_f := 0.9$  LRFD [5.5.4.2]. Therefore, the factored flexural resistance is:

$$M_{ry} := \phi_f \cdot M_{ny} \qquad M_{ry} = 559.7 \text{ kip} \cdot \text{ft}$$

If the factored axial load is less than  $\phi_c f'_c A_g$ : LRFD [5.6.4.5]

$$\frac{M_{uy}}{M_{ry}} + \frac{M_{uz}}{M_{rz}} < 1.00 \qquad \frac{M_{uy}}{M_{ry}} + \frac{M_{uz}}{M_{rz}} = 0.95$$

| Is 0.95 < 1.0 ? **Yes** check = OK



**E39-1.8 Shear Capacity**

For rectangular section behavior (vertical loading):

The nominal shear resistance of the section is calculated as follows, **LRFD [5.7.3.3]**:

$$V_n := \min (V_c + V_s + V_p, 0.25 \cdot f'_c \cdot b_v \cdot d_v + V_p)$$

The nominal shear of the concrete is calculated as follows:

$$V_c := 0.0316 \cdot \beta \cdot \lambda \cdot \sqrt{f'_c} \cdot b_v \cdot d_v$$

$$\beta := 2 \quad \text{Simplified procedure LRFD 5.7.3.4.1}$$

$$\lambda := 1 \quad \text{Concrete density modification factor LRFD 5.4.2.8}$$

$$b_v := b \quad b_v = 66.00 \text{ in}$$

$$\text{Clr}_{cov} := 3.00 \text{ in} \quad \text{Bottom bar clear cover}$$

Determine effective shear depth,  $d_v$ :

For non-prestressed sections:

$$d_e := d_{vert} \quad \text{LRFD 5.7.2.8-2} \quad d_e = 61.81 \text{ in}$$

$d_v$  is the maximum of the following three equations: **LRFD 5.7.2.8**

$$d_{v1} := d_{vert} - \frac{a_{vert}}{2} \quad d_{v1} = 60.73 \text{ in}$$

$$d_{v2} := 0.9 \cdot d_e \quad d_{v2} = 55.63 \text{ in}$$

$$d_{v3} := 0.72 \cdot H_{barrier} \quad d_{v3} = 47.52 \text{ in}$$

$$d_v := \max (d_{v1}, d_{v2}, d_{v3}) \quad d_v = 60.73 \text{ in}$$

$$V_c := 0.0316 \cdot \beta \cdot \lambda \cdot \sqrt{f'_c} \cdot b_v \cdot d_v \quad V_c = 473.9 \text{ kips}$$

The shear resistance provided by transverse reinforcement

$$V_s := \frac{A_v \cdot f_y \cdot d_v \cdot \cot(\theta)}{s}$$

$$\theta := 45 \text{ deg} \quad \text{Simplified procedure LRFD 5.7.3.4.1}$$

$$A_v := 0.88 \text{ in}^2 \quad \text{\#6 stirrups (2 legs)}$$

$$s := 6.00 \text{ in} \quad \text{Stirrup spacing}$$



$$V_s := \frac{A_v \cdot f_y \cdot d_v \cdot \cot\left(\theta \cdot \frac{\pi}{180}\right)}{s} \qquad V_s = 534.4 \text{ kips}$$

$$V_{n1} := V_c + V_s + V_p \qquad V_{n1} = 1008.3 \text{ kips}$$

$$V_{n2} := 0.25 \cdot f'_c \cdot b_v \cdot d_v + V_p \qquad V_{n2} = 3507.0 \text{ kips}$$

$$V_n := \min(V_{n1}, V_{n2}) \qquad V_n = 1008.3 \text{ kips}$$

For reinforced concrete sections:

$\phi_v := 0.9$  **LRFD [5.5.4.2]**. Therefore, the factored shear resistance is:

$$V_{ry} := \phi_v \cdot V_n \qquad V_{ry} = 907.5 \text{ kips}$$

For rectangular section behavior (transverse loading):

The nominal shear resistance of the section is calculated as follows, **LRFD [5.7.3.3]**:

$$V_n := \min(V_c + V_s + V_p, 0.25 \cdot f'_c \cdot b_v \cdot d_v + V_p)$$

The nominal shear of the concrete is calculated as follows:

$$V_c := 0.0316 \cdot \beta \cdot \lambda \cdot \sqrt{f'_c} \cdot b_v \cdot d_v$$

$$\beta := 2 \qquad \text{Simplified procedure } \mathbf{LRFD 5.7.3.4.1}$$

$$\lambda := 1 \qquad \text{Concrete density modification factor } \mathbf{LRFD 5.4.2.8}$$

$$b_v := b \qquad b_v = 66.00 \text{ in}$$

$$Clr\_cov := 2.00 \text{ in} \qquad \text{Side bar clear cover}$$

Determine effective shear depth,  $d_v$ :

For non-prestressed sections:

$$d_e := d_{horiz} \qquad \mathbf{LRFD 5.7.2.8-2} \qquad d_e = 35.88 \text{ in}$$

$d_v$  is the maximum of the following three equations: **LRFD 5.7.2.8**

$$d_{v1} := d_{horiz} - \frac{a_{horiz}}{2} \qquad d_{v1} = 35.34 \text{ in}$$

$$d_{v2} := 0.9 \cdot d_e \qquad d_{v2} = 32.29 \text{ in}$$

$$d_{v3} := 0.72 \cdot W_{barrier\_str} \qquad d_{v3} = 28.08 \text{ in}$$



$$d_v := \max(d_{v1}, d_{v2}, d_{v3}) \qquad d_v = 35.34 \text{ in}$$

$$V_c := 0.0316 \cdot \beta \cdot \lambda \cdot \sqrt{f'_c} \cdot b_v \cdot d_v \qquad V_c = 275.8 \text{ kips}$$

The shear resistance provided by transverse reinforcement

$$V_s := \frac{A_v \cdot f_y \cdot d_v \cdot \cot(\theta)}{s}$$

$\theta := 45$  deg Simplified procedure **LRFD 5.7.3.4.1**

$A_v := 0.88$  in<sup>2</sup> #6 stirrups (2 legs)

$s := 6.00$  in Stirrup spacing

$$V_s := \frac{A_v \cdot f_y \cdot d_v \cdot \cot\left(\theta \cdot \frac{\pi}{180}\right)}{s} \qquad V_s = 311.0 \text{ kips}$$

$$V_{n1} := V_c + V_s + V_p \qquad V_{n1} = 586.7 \text{ kips}$$

$$V_{n2} := 0.25 \cdot f'_c \cdot b_v \cdot d_v + V_p \qquad V_{n2} = 2040.7 \text{ kips}$$

$$V_n := \min(V_{n1}, V_{n2}) \qquad V_n = 586.7 \text{ kips}$$

For reinforced concrete sections:

$\phi_v := 0.90$  **LRFD [5.5.4.2]**. Therefore, the factored shear resistance is:

$$V_{rz} := \phi_v \cdot V_n \qquad V_{rz} = 528.1 \text{ kips}$$

Check combined shear::

$$\frac{V_{uy}}{V_{ry}} + \frac{V_{uz}}{V_{rz}} < 1.0$$

$$\frac{V_{uz}}{V_{rz}} + \frac{V_{uz}}{V_{rz}} = 0.47 \qquad \text{Is } 0.47 < 1.0? \quad \text{Yes} \qquad \text{check} = \text{OK}$$

E39-1.9 Check Reinforcement at Top of Drilled Shaft

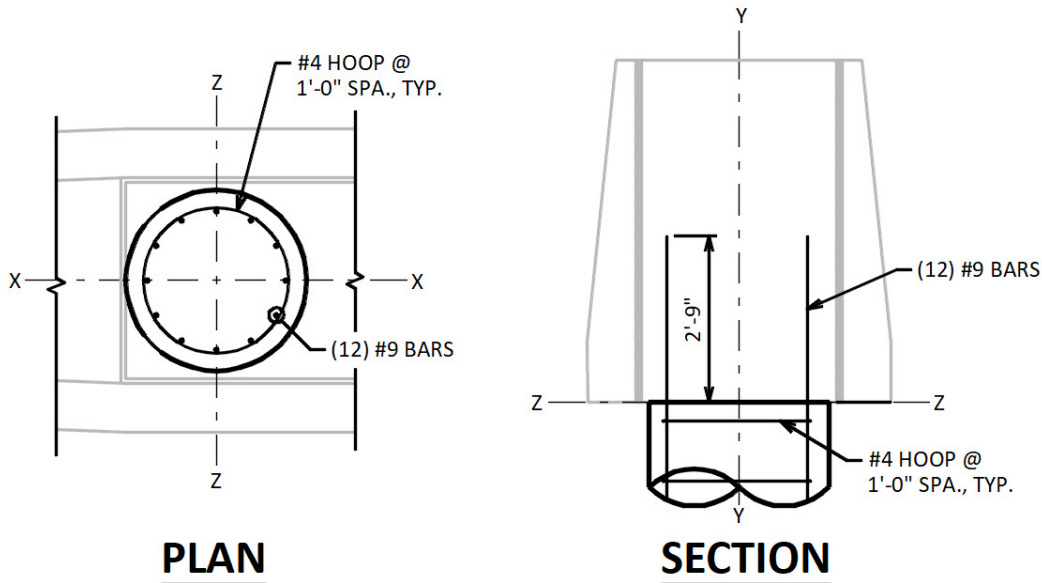

Check Case II - TL-5 Loading at C/L of drilled shaft, this develops the maximum moment and shear at the top of the drilled shaft. It is assumed that the adjacent pavement prevents the shaft from rotating, therefore only in the interface between the shaft and cap need be check for this loading. This example also conservatively assumes only one shaft resists the TL-5 loading.

$$F_x := F_L \qquad F_x = 41.0 \text{ kips}$$

$$F_y := 0.5 \cdot W_{DC} \cdot L_{barrier} + F_v \qquad F_y = 108.7 \text{ kips}$$

$$F_z := F_t \qquad F_z = 124.0 \text{ kips}$$

$$M_x := F_z \cdot H_{barrier} \cdot \frac{1}{12} \qquad \text{Conservatively ignore vertical load} \qquad M_x = 682.0 \text{ kip} \cdot \text{ft}$$

$$M_y := F_x \cdot (0.5 \cdot W_{barrier\_top}) \cdot \frac{1}{12} \qquad M_y = 83.7 \text{ kip} \cdot \text{ft}$$

$$M_z := F_x \cdot H_{barrier} \cdot \frac{1}{12} \qquad M_z = 225.5 \text{ kip} \cdot \text{ft}$$

Check shear resistance:

Assume shaft reinforcement is #9 bars vertical with #4 ties:

$$dia_4 := 0.50 \text{ in}$$

$$dia_9 := 1.128 \text{ in}$$

$$clr\_cov := 3.00 \text{ in}$$

The nominal shear resistance of the section is calculated as follows, **LRFD [5.7.3.3]**:

$$V_n := \min(V_c + V_s + V_p, 0.25 \cdot f'_c \cdot b_v \cdot d_v + V_p)$$



The nominal shear of the concrete is calculated as follows:

$$V_c := 0.0316 \cdot \beta \cdot \lambda \cdot \sqrt{f'_c} \cdot b_v \cdot d_v$$

$$\beta := 2$$

Simplified procedure **LRFD 5.7.3.4.1**

$$\lambda := 1$$

Concrete density modification factor **LRFD 5.4.2.8**

$$b_v := Diam_{shaft} \cdot 12$$

$$b_v = 36.00 \text{ in}$$

$$d_e := \frac{b_v}{2} + \frac{(b_v - 2 \cdot (clr_{cov} + dia_4) - dia_9)}{\pi}$$

$$d_e = 26.87 \text{ in}$$

$$d_v := 0.9 \cdot d_e$$

Effective shear depth **LRFD C5.7.2.8-2**

$$d_v = 24.18 \text{ in}$$

$$V_c := 0.0316 \cdot \beta \cdot \lambda \cdot \sqrt{f'_c} \cdot b_v \cdot d_v$$

$$V_c = 102.9 \text{ kips}$$

The shear resistance provided by transverse reinforcement

$$V_s := \frac{A_v \cdot f_y \cdot d_v \cdot \cot(\theta)}{s}$$

$$\theta := 45 \text{ deg}$$

Simplified procedure **LRFD 5.7.3.4.1**

$$A_v := 0.40 \text{ in}^2$$

#4 ties (2 legs)

$$s := 12.00 \text{ in}$$

Stirrup spacing

$$V_s := \frac{A_v \cdot f_y \cdot d_v \cdot \cot\left(\theta \cdot \frac{\pi}{180}\right)}{s}$$

$$V_s = 48.4 \text{ kips}$$

$$V_{n1} := V_c + V_s + V_p$$

$$V_{n1} = 152.3 \text{ kips}$$

$$V_{n2} := 0.25 \cdot f'_c \cdot b_v \cdot d_v + V_p$$

$$V_{n2} = 762.8 \text{ kips}$$

$$V_n := \min(V_{n1}, V_{n2})$$

$$V_n = 152.3 \text{ kips}$$

For reinforced concrete sections:

$\phi_v := 0.9$  **LRFD [5.5.4.2]**. Therefore, the factored shear resistance is:

$$V_r := \phi_v \cdot V_n$$

$$V_r = 137.1 \text{ kips}$$

$$V_u := \sqrt{F_x^2 + F_z^2}$$

$$V_u = 130.6 \text{ kips}$$

Is  $V_u = 130.6 \text{ kips} < V_r = 142.0 \text{ kips}$ ? **Yes**

check = OK



Check the top of drilled shaft as a reinforced concrete column:

The assessment of the resistance of a compression member with biaxial flexure is dependent upon the magnitude of the factored axial load. If the factored axial load is less than ten percent of the gross concrete strength multiplied by the phi-factor for compression members, then use Equation 5.6.4.5-3. Otherwise, use Equation 5.7.4.5-1. Regardless of which equation in the above paragraph controls, commercially available software is generally used to obtain the moment and axial load resistances.

The procedure as discussed above is carried out as follows:

$\phi := 0.75$  **LRFD [5.5.4.2]**. Therefore, the factored shear resistance is:

$$A_g := \frac{\pi \cdot (Diam_{shaft} \cdot 12)^2}{4} \qquad A_g = 1017.9 \text{ in}^2$$

$$0.10 \cdot \phi \cdot f'_c \cdot A_g = 267.2 \text{ kips}$$

$$P_r := \phi \cdot f'_c \cdot A_g = 2671.9 \text{ kips}$$

$$0.10 \cdot P_r = 267.2 \text{ kips}$$

$$F_y = 108.7 \text{ kips} < 267.2 \text{ kips} \quad \text{Therefore, use LRFD [Equation 5.6.4.5-3]}$$

$$M_{ux} := M_x \qquad M_{ux} = 682.0 \text{ kip} \cdot \text{ft}$$

$$M_{uz} := M_z \qquad M_{uz} = 225.5 \text{ kip} \cdot \text{ft}$$

$$M_u := \sqrt{M_{ux}^2 + M_{uz}^2} \qquad M_u = 718.3 \text{ kip} \cdot \text{ft}$$

$$M_r := 719.0 \text{ kip} \cdot \text{ft}$$

$$\frac{M_u}{M_r} = 0.999 \qquad \text{Is } 0.999 < 1.0 ? \quad \text{Yes} \quad \text{check} = \text{OK}$$

The factored flexural resistances shown above,  $M_r$ , was obtained by the use of commercial software.

### E39-1.10 Interface Shear Transfer

Check interface shear capacity across construction joint between transition barrier section and foundation cap per **LRFD 5.7.4**.

Per SDD-14B32 the standard barrier transition section has 6 - #5 horizontal bars on each face continuing across the interface construction joint between the barrier transition and foundation cap sections.

Area of shear reinforcement crossing the shear plane

$$A_{st\_5} := 0.31 \text{ in}^2 \quad \text{Area of \#5 bar}$$

$$A_{vf} := 2 \cdot 6 \cdot A_{st\_5} \quad A_{vf} = 3.72 \text{ in}^2$$

Calculate shear resistance. For purpose of determining shear transfer contact area, use gross combined area of resisting foundation cap section and integral barriers.

$$A_{cv} := Area_{barrier} \cdot 144 \quad A_{cv} = 3671 \text{ in}^2$$

Check that minimum shear interface reinforcement is provided per LRFD 5.7.4.2:

$$A_{vf\_min} := \frac{0.05 \cdot A_{cv}}{f_y} \quad \text{LRFD 5.7.4.2-1} \quad A_{vf\_min} = 3.06 \text{ in}^2$$

$$\text{Is } A_{vf\_min} < A_{vf} = 3.72 \text{ in}^2 \quad \text{Yes} \quad \text{check} = \text{OK}$$

Summary: Due to the 1" filler between the cap and barrier shown in SDD-14B32, there is no friction between the concrete surfaces, shear is resisted by reinforcing steel only. Shear interface reinforcement of 12 - #5 bars per SDD-14B32 is adequate.

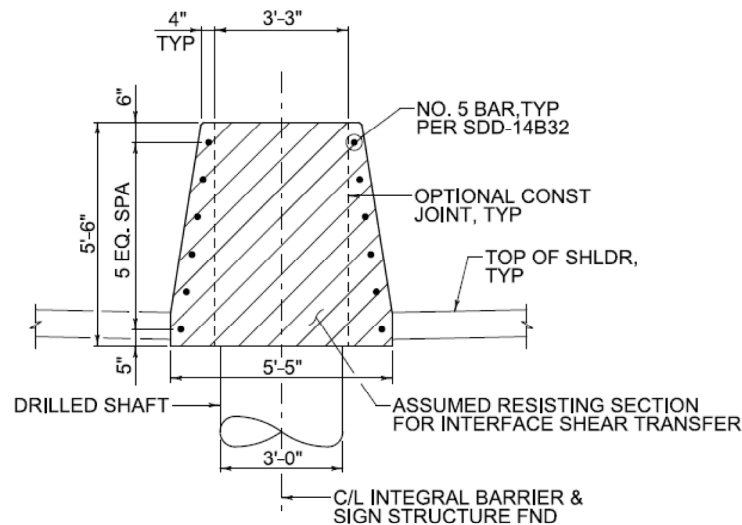

**INTEGRAL BARRIER SECTION**

Check interface shear capacity across construction joint between drilled shaft and foundation cap per LRFD 5.7.4. Conservatively assumes a single shaft.

(12) #9 bars cross the shear plane at the top of the drilled shaft.

$$A_{st\_9} := 12 \cdot \pi \cdot \left( \frac{dia_9}{2} \right)^2 \quad A_{st\_9} = 11.992 \text{ in}^2$$

Calculate interface shear resistance. For purpose of determining shear transfer contact area, use gross combined area of resisting foundation cap section and one drilled shaft.





$$A_{cv\_shaft} := \pi \cdot \left( \frac{Diam_{shaft}}{2} \right)^2 \cdot 144 \qquad A_{cv\_shaft} = 1017.876 \text{ in}^2$$

Check that minimum shear interface reinforcement is provided per LRFD 5.7.4.2:

$$A_{vf\_min} := \frac{0.05 \cdot A_{cv\_shaft}}{f_y} \qquad \text{LRFD 5.7.4.2-1} \qquad A_{vf\_min} = 0.85 \text{ in}^2$$

$$\text{Is } A_{vf\_min} < A_{st\_9} = 11.992 \text{ in}^2 \qquad \text{Yes} \qquad \text{check} = \text{OK}$$

Calculate factored interface shear force due to TL-5 vehicular collision forces only:

$$V_{CT} := \left( V_{z\_CT}^2 + V_{y\_CT}^2 \right)^{0.5} \qquad V_{CT} = 147.57 \text{ Kips}$$

Vehicle collision force is extreme event limit state, therefore load factor = 1.0:

$$V_{ui} := 1.0 \cdot V_{CT} \qquad V_{ui} = 147.57 \text{ Kips}$$

Assume clean construction joint, not intentionally roughened. Per LRFD 5.7.4.3:

$$c_{cv} := 0.075$$

$$\mu := 0.6$$

$$K_1 := 0.2$$

$$K_2 := 0.8$$

Permanent axial compression across shear interface = 0 (conservative)

The nominal shear interface (shear friction) capacity is the smallest of following three equations:

$$V_{nsf1} := c_{cv} \cdot A_{cv\_shaft} + \mu \cdot A_{st\_9} \cdot f_y \qquad \text{LRFD 5.7.4.3-3} \qquad V_{nsf1} = 508.05 \text{ Kips}$$

$$V_{nsf2} := K_1 \cdot f'_c \cdot A_{cv\_shaft} \qquad \text{LRFD 5.7.4.3-4} \qquad V_{nsf2} = 712.51 \text{ Kips}$$

$$V_{nsf3} := K_2 \cdot A_{cv\_shaft} \qquad \text{LRFD 5.7.4.3-5} \qquad V_{nsf3} = 814.3 \text{ Kips}$$

Nominal shear interface (shear friction) capacity:

$$V_{nsf} := \min(V_{nsf1}, V_{nsf2}, V_{nsf3}) \qquad V_{nsf} = 508.05 \text{ Kips}$$

Factored shear interface resistance; for extreme event loading:

$$\phi_{si} := 1.0 \qquad \text{LRFD 5.7.4.3}$$



Therefore, the factored interface shear resistance is:

$$V_{ri} := \phi_{si} \cdot V_{nsf} \qquad V_{ri} = 508.05 \text{ Kips}$$

$$\frac{V_{ui}}{V_{ri}} = 0.2905 \qquad \text{Is } V_{ui} < V_{ri} = 508.25 \text{ kips? } \text{Yes} \qquad \text{check} = \text{OK}$$

Summary: Shear interface reinforcement at the top of the shaft of 12 - #9 bars is adequate. A shear key should be provided at the top of the shaft as shown in the standard plans.



Table of Contents

E39-2 Design of Sign Bridge Concrete Column for Vehicle Impact .....	2
E39-2.1 Design Criteria .....	2
E39-2.2 Vehicular Collision Force .....	3
E39-2.3 Limit States and Combinations .....	3
E39-2.4 Analysis .....	3
E39-2.5 Flexural Strength Capacity .....	4
E39-2.6 Shear Capacity .....	5
E39-2.7 Analysis and Design Check for Case II Loading .....	8
E39-2.8 Summary Sketch E39-2.9 Column to Foundation Cap Interface Shear Check .....	9



E39-2 Design of Sign Bridge Concrete Column for Vehicle Impact

This example shows design calculations for a four chord sign bridge concrete column supported on a concrete foundation cap beam that is impacted by a vehicular collision force. The AASHTO LRFD Bridge Design Specifications 8th Edition - 2017 are followed for the column design assuming the equivalent static force acts in a direction of zero to 15 degrees with the edge of pavement in a horizontal plane.

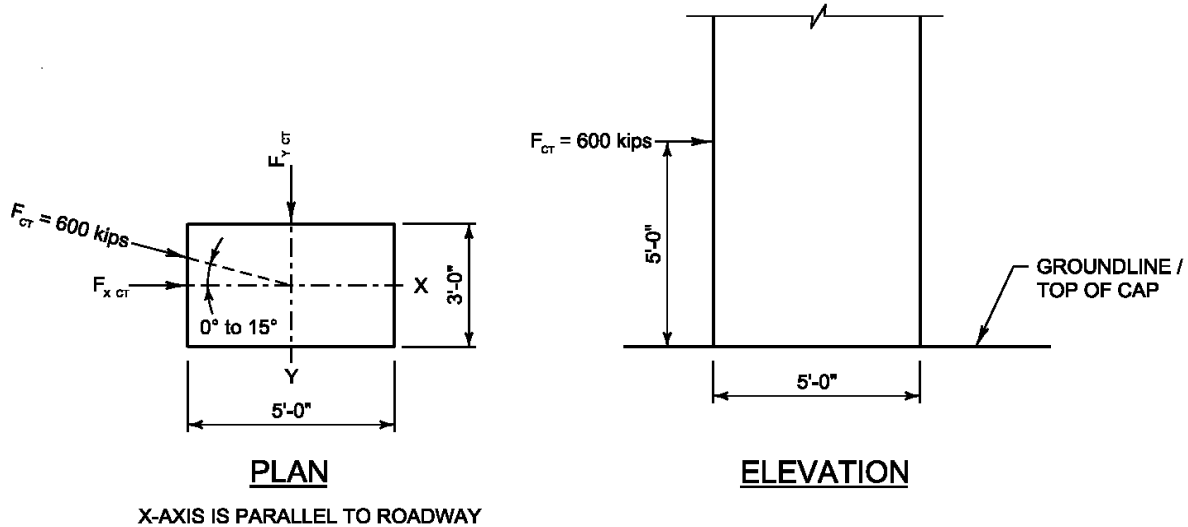

E39-2.1 Design Criteria

Column Material Properties

- $f_{c\_col} := 3.5$  ksi      Concrete Strength
- $f_y := 60$  ksi      Yield Strength of Reinforcement
- $E_s := 29000$  ksi      modulus of elasticity of steel
- $w_c := 0.150$  kcf      Unit Weight of concrete

Footing Material Properties

- $f_{c\_ftg} := 3.5$  ksi      Concrete Strength

Column Geometry

- $W_{col} := 3.00$  ft      Width of Column
- $L_{col} := 5.00$  ft      Length of Column at Base

Footing Geometry

- $W_{ftg} := 3.25$  ft      Width of Footing
- $L_{ftg} := 12.00$  ft      Length of Footing



E39-2.2 Vehicular Collision Force

F<sub>CT</sub> := 600.0 kips Vehicular impact design force [LRFD 3.6.5.1]

H<sub>CT</sub> := 5.00 ft Height of vehicular impact design force above ground [LRFD 3.6.5.1]

Equivalent static force is assumed to act in a direction of zero to 15 degrees with the edge of the pavement. Two load cases will be analyzed:

Case I - Angle of Force = 15 deg

Case II - Angle of Force = 0 deg

E39-2.3 Limit States and Combinations

Limit State Extreme Event II for vehicle collision shall be applied using the following equation and load factors from LRFD Table 3.4.1-1 & Table 3.4.1-4.

V<sub>u</sub> := 1.0·DC + 0.5·LL + 1.0IC + 1.0·CT

M<sub>u</sub> := 1.0·DC + 0.5·LL + 1.0IC + 1.0·CT

E39-2.4 Analysis

Sign bridge column will be analyzed as a cantilever fixed at the column base.

Case I - Equivalent Static Load acting at 15 deg with edge of pavement

V<sub>x\_DC</sub> := 0.0

V<sub>x\_LL</sub> := 0.0

V<sub>x\_IC</sub> := 0.0

V<sub>x\_CT</sub> := F<sub>CT</sub>·cos(15·π/180) [V<sub>x\_CT</sub> = 579.6] kips

V<sub>ux</sub> := 1.0V<sub>x\_DC</sub> + 0.5V<sub>x\_LL</sub> + 1.0·V<sub>x\_IC</sub> + 1.0·V<sub>x\_CT</sub> [V<sub>ux</sub> = 579.6] kips

V<sub>y\_DC</sub> := 0.0

V<sub>y\_LL</sub> := 0.0

V<sub>y\_IC</sub> := 0.0

V<sub>y\_CT</sub> := F<sub>CT</sub>·sin(15·π/180) [V<sub>y\_CT</sub> = 155.3] kips

V<sub>uy</sub> := 1.0V<sub>y\_DC</sub> + 0.5V<sub>y\_LL</sub> + 1.0·V<sub>y\_IC</sub> + 1.0·V<sub>y\_CT</sub> [V<sub>uy</sub> = 155.3] kips

M<sub>x\_DC</sub> := 0.0

M<sub>x\_LL</sub> := 0.0

M<sub>x\_IC</sub> := 0.0

M<sub>x\_CT</sub> := (F<sub>CT</sub>·sin(15·π/180))·H<sub>CT</sub> [M<sub>x\_CT</sub> = 776.5] kip·ft

M<sub>ux</sub> := 1.0M<sub>x\_DC</sub> + 0.5M<sub>x\_LL</sub> + 1.0·M<sub>x\_IC</sub> + 1.0·M<sub>x\_CT</sub> [M<sub>ux</sub> = 776.5] kip·ft

M<sub>y\_DC</sub> := 0.0

M<sub>y\_LL</sub> := 0.0

M<sub>y\_IC</sub> := 0.0



$$M_{y\_CT} := F_{CT} \cdot H_{CT} \cdot \cos\left(15 \cdot \frac{\pi}{180}\right) \quad \boxed{M_{y\_CT} = 2897.8} \text{ kip}\cdot\text{ft}$$

$$M_{uy} := 1.0M_{y\_DC} + 0.5M_{y\_LL} + 1.0 \cdot M_{y\_IC} + 1.0 \cdot M_{y\_CT} \quad \boxed{M_{uy} = 2897.8} \text{ kip}\cdot\text{ft}$$

E39-2.5 Flexural Strength Capacity

For rectangular section behavior (longitudinal loading):

$$c := \frac{A_s \cdot f_y}{\alpha_1 \cdot f'_{c\_col} \cdot \beta_1 \cdot b}$$

**LRFD [5.6.2.2]**  $\alpha_1 := 0.85$  (for  $f'_c < 10.0\text{ksi}$ )

$$\beta_1 := \max[0.85 - (f'_{c\_col} - 4) \cdot 0.05, 0.65] \quad \boxed{\beta_1 = 0.875}$$

$$b := W_{col} \cdot 12 \quad \boxed{b = 36.00} \text{ in}$$

It is assumed that bundled #11 bars are used for the column vertical reinforcement. The bars are fully developed at the bottom of the column by utilizing standard 180 degree hooks.

Try: Bar size #11  $A_{st\_11} := 1.56 \text{ in}^2$   $Num\_bars := 12$

$$A_s := A_{st\_11} \cdot Num\_bars \quad \boxed{A_s = 18.72} \text{ in}$$

$$c := \frac{A_s \cdot f_y}{\alpha_1 \cdot f'_{c\_col} \cdot \beta_1 \cdot b} \quad \boxed{c = 11.99} \text{ in}$$

$$a := \beta_1 \cdot c \quad \boxed{a = 10.49} \text{ in}$$

$Clr\_cov := 2.50$  in Column tie clear cover

$dia_5 := 0.625$  in Diameter of tie bars

$dia_{11} := 1.41$  in Diameter of vertical column bars

$$d_{long} := L_{col} \cdot 12 - Clr\_cov - dia_5 - dia_{11} \quad \boxed{d_{long} = 55.47} \text{ in}$$

$$M_{ny} := A_s \cdot f_y \cdot \left(d_{long} - \frac{a}{2}\right) \cdot \frac{1}{12} \quad \boxed{M_{ny} = 4700.7} \text{ kip}\cdot\text{ft}$$

For reinforced concrete sections:

$\phi_f := 0.9$  **LRFD [5.5.4.2]**. Therefore, the factored flexural resistance is:

$$M_{ry} := \phi_f M_{ny} \quad \boxed{M_{ry} = 4230.6} \text{ kip}\cdot\text{ft}$$



For rectangular section behavior (transverse loading):

b := L\_col · 12 b = 60.00 in

Try: Bar size #11 A<sub>st\_11</sub> := 1.56 in<sup>2</sup> Num\_bars := 14

A<sub>s</sub> := A<sub>st\_11</sub> · Num\_bars A<sub>s</sub> = 21.84 in

c :=  $\frac{A_s \cdot f_y}{\alpha_1 \cdot f'_{c\_col} \cdot \beta_1 \cdot b}$  c = 8.39 in

a := β<sub>1</sub> · c a = 7.34 in

d<sub>tran</sub> := W\_col · 12 – Clr\_cov – dia<sub>5</sub> – dia<sub>11</sub> d<sub>tran</sub> = 31.46 in

M<sub>nx</sub> := A<sub>s</sub> · f<sub>y</sub> ·  $\left(d_{tran} - \frac{a}{2}\right) \cdot \frac{1}{12}$  M<sub>nx</sub> = 3035.1 kip·ft

For reinforced concrete sections:

φ<sub>f</sub> := 0.9 **LRFD [5.5.4.2]**. Therefore, the factored flexural resistance is:

M<sub>rx</sub> := φ<sub>f</sub> · M<sub>nx</sub> M<sub>rx</sub> = 2731.6 kip·ft

If the factored axial load is less than φ<sub>c</sub> · f<sub>c</sub> · A<sub>g</sub>: **LRFD [5.6.4.5]**

$\frac{M_{ux}}{M_{rx}} + \frac{M_{uy}}{M_{ry}} < 1.00$   $\frac{M_{ux}}{M_{rx}} + \frac{M_{uy}}{M_{ry}} = 0.97$

Is 0.97 ≤ 1.0? **Yes** check = OK

E39-2.6 Shear Capacity

Compute shear resistance in the longitudinal direction (V<sub>rx</sub>):

The nominal shear resistance of the section is calculated as follows, **LRFD [5.7.3.3]**:

V<sub>n</sub> := min(V<sub>c</sub> + V<sub>s</sub> + V<sub>p</sub>, 0.25 · f'<sub>c\_col</sub> · b<sub>v</sub> · d<sub>v</sub> + V<sub>p</sub>)

The nominal shear of the concrete is calculated as follows:

V<sub>c</sub> := 0.0316 · β · λ · √f'<sub>c\_col</sub> · b<sub>v</sub> · d<sub>v</sub>

β := 2 Simplified procedure **LRFD 5.7.3.4.1**

λ := 1 Concrete density modification factor **LRFD 5.4.2.8**

b<sub>v</sub> := b b<sub>v</sub> = 60.00 in



Determine effective shear depth,  $d_v$ :

For non-prestressed sections:

$d_e := d_{long}$  **LRFD 5.7.2.8-2**  $d_e = 55.47$  in

$d_v$  is the maximum of the following three equations: **LRFD 5.7.2.8**

$d_{v1} := d_{long} - \frac{a_{long}}{2}$   $d_{v1} = 50.22$  in

$d_{v2} := 0.9 \cdot d_e$   $d_{v2} = 49.92$  in

$d_{v3} := 0.72 \cdot L_{col} \cdot 12$   $d_{v3} = 43.20$  in

$d_v := \max(d_{v1}, d_{v2}, d_{v3})$   $d_v = 50.22$  in

$V_c := 0.0316 \cdot \beta \cdot \lambda \cdot \sqrt{f'_{c\_col}} \cdot b_v \cdot d_v$   $V_c = 356.3$  kips

The shear resistance provided by transverse reinforcement

$V_s := \frac{A_v \cdot f_y \cdot d_v \cdot \cot(\theta)}{s}$

deg 45 Simplified procedure **LRFD 5.7.3.4.1**

$A_v := 1.24$  in<sup>2</sup> #5 double stirrups (4 legs of stirrups)

$s := 6.0$  in Stirrup spacing

$V_s := \frac{A_v \cdot f_y \cdot d_v \cdot \cot\left(\theta \cdot \frac{\pi}{180}\right)}{s}$   $V_s = 622.7$  kips

$V_{n1} := V_c + V_s + V_p$   $V_{n1} = 979.0$  kips

$V_{n2} := 0.25 \cdot f'_{c\_col} \cdot b_v \cdot d_v + V_p$   $V_{n2} = 2636.6$  kips

$V_n := \min(V_{n1}, V_{n2})$   $V_n = 979.0$  kips

For reinforced concrete sections:

$\phi_v := 0.90$  **LRFD [5.5.4.2]**. Therefore, the factored shear resistance is:

$V_{rx} := \phi_v \cdot V_n$   $V_{rx} = 881.1$  kips





Compute shear resistance in the transverse direction ( $V_{TV}$ ):

The nominal shear resistance of the section is calculated as follows, LRFD [5.7.3.3]:

$$V_n := \min(V_c + V_s + V_p, 0.25 \cdot f'_{c\_col} \cdot b_v \cdot d_v + V_p)$$

The nominal shear of the concrete is calculated as follows:

$$V_c := 0.0316 \cdot \beta \cdot \lambda \cdot \sqrt{f'_{c\_col}} \cdot b_v \cdot d_v$$

$\beta := 2$  Simplified procedure LRFD 5.7.3.4.1

$\lambda := 1$  Concrete density modification factor LRFD 5.4.2.8

$b_v := b$   $b_v = 60.00$  in

Determine effective shear depth,  $d_v$ :

For non-prestressed sections:

$d_e := d_{tran}$  LRFD 5.7.2.8-2  $d_e = 31.46$  in

$d_v$  is the maximum of the following three equations: LRFD 5.7.2.8

$d_{v1} := d_{tran} - \frac{a_{tran}}{2}$   $d_{v1} = 27.79$  in

$d_{v2} := 0.9 \cdot d_e$   $d_{v2} = 28.32$  in

$d_{v3} := 0.72 \cdot W_{col} \cdot 12$   $d_{v3} = 25.92$  in

$d_v := \max(d_{v1}, d_{v2}, d_{v3})$   $d_v = 28.32$  in

$V_c := 0.0316 \cdot \beta \cdot \lambda \cdot \sqrt{f'_{c\_col}} \cdot b_v \cdot d_v$   $V_c = 200.9$  kips

The shear resistance provided by transverse reinforcement

$$V_s := \frac{A_v \cdot f_y \cdot d_v \cdot \cot(\theta)}{s}$$

$\theta := 45$  deg Simplified procedure LRFD 5.7.3.4.1

$A_v := 1.24$  in<sup>2</sup> #5 double stirrups (4 legs of stirrups)

$s := 6.0$  in Stirrup spacing



$$V_s := \frac{A_v \cdot f_y \cdot d_v \cdot \cot\left(\theta \cdot \frac{\pi}{180}\right)}{s}$$

$$V_s = 351.1 \text{ kips}$$

$$V_{n1} := V_c + V_s + V_p$$

$$V_{n1} = 552.0 \text{ kips}$$

$$V_{n2} := 0.25 \cdot f_{c\_col} \cdot b_v \cdot d_v + V_p$$

$$V_{n2} = 1486.7 \text{ kips}$$

$$V_n := \min(V_{n1}, V_{n2})$$

$$V_n = 552.0 \text{ kips}$$

For reinforced concrete sections:

$\phi_v := 0.90$  **LRFD [5.5.4.2]**. Therefore, the factored shear resistance is:

$$V_{ry} := \phi_v \cdot V_n$$

$$V_{ry} = 496.8 \text{ kips}$$

Check combined shear:

$$\frac{V_{uy}}{V_{ry}} + \frac{V_{uz}}{V_{rz}} < 1.0$$

$$\frac{V_{ux}}{V_{rx}} + \frac{V_{uy}}{V_{ry}} = 0.97$$

Is  $0.97 \leq 1.0$ ? **Yes**

**check = OK**

### E39-2.7 Analysis and Design Check for Case II Loading

Case II - Equivalent Static Load acting at 0 deg with edge of pavement

$$V_{x\_DC} := 0.0$$

$$V_{x\_LL} := 0.0$$

$$V_{x\_IC} := 0.0$$

$$V_{x\_CT} := F_{CT} \cdot \cos\left(0 \cdot \frac{\pi}{180}\right)$$

$$V_{x\_CT} = 600.0 \text{ kips}$$

$$V_{ux} := 1.0V_{x\_DC} + 0.5V_{x\_LL} + 1.0 \cdot V_{x\_IC} + 1.0 \cdot V_{x\_CT}$$

$$V_{ux} = 600.0 \text{ kips}$$

$$M_{y\_DC} := 0.0$$

$$M_{y\_LL} := 0.0$$

$$M_{y\_IC} := 0.0$$

$$M_{y\_CT} := F_{CT} \cdot H_{CT} \cdot \cos\left(0 \cdot \frac{\pi}{180}\right)$$

$$M_{y\_CT} = 3000.0 \text{ kip}\cdot\text{ft}$$

$$M_{uy} := 1.0M_{y\_DC} + 0.5M_{y\_LL} + 1.0 \cdot M_{y\_IC} + 1.0 \cdot M_{y\_CT}$$

$$M_{uy} = 3000.0 \text{ kip}\cdot\text{ft}$$

Check Shear:

$$V_{rx} = 881.1 \text{ kips}$$

Is  $940.4 > 600.0$ ? **Yes**

**check = OK**

Check Moment:

$$M_{ry} = 4230.6 \text{ kip}\cdot\text{ft}$$

Is  $4285.9 > 3000.0$ ? **Yes**

**check = OK**



E39-2.8 Summary Sketch

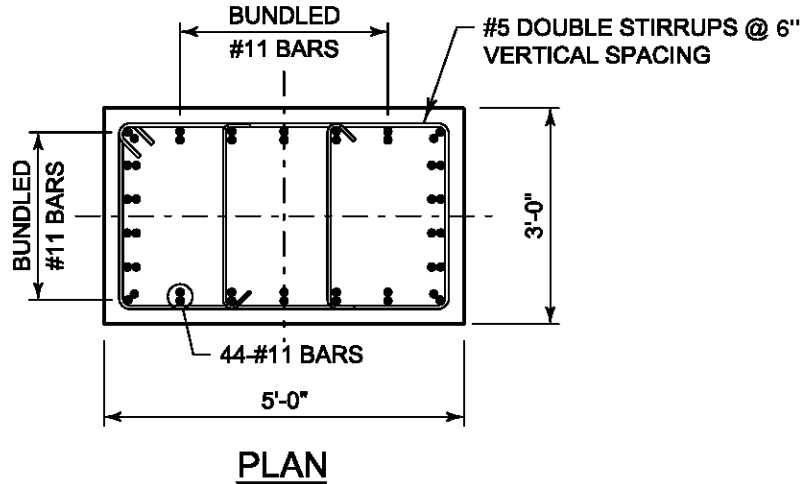

E39-2.9 Column to Foundation Cap Interface Shear Check

Confirm the shear capacity at the column to foundation cap interface per **LRFD 5.7.4**.

Refer to **E13-1.9.3** for an example of this calculation. Following this example calculation the factored interface shear resistance is determined to be 1,512 kips with  $\phi = 1.0$  for the extreme limit state per **LRFD 5.7.4.3**. This far exceeds the factored shear force  $V_u = 600$  kips due to the vehicular collision force and therefore the column to foundation cap interface shear capacity is adequate.



This page intentionally left blank.