

TYPE I

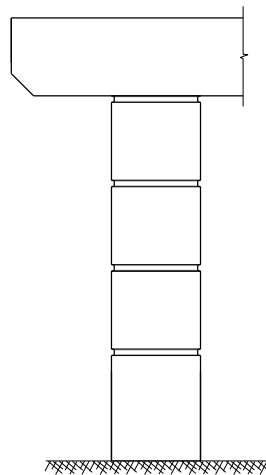

(P1) SINGLE RUSTICATION LINES

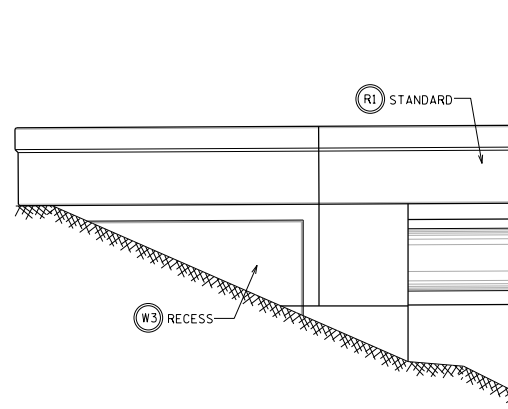

TYPE III

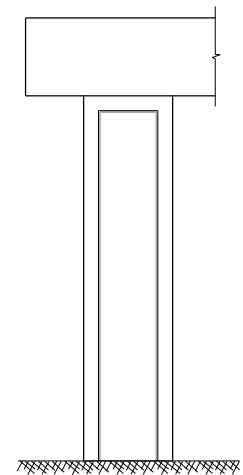

(P3) RECESSED PANEL

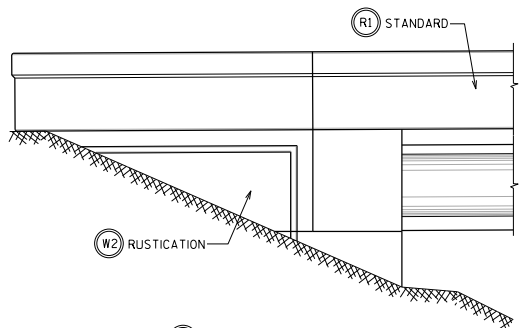

TYPE II

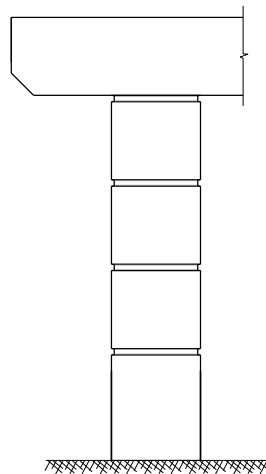

(P1) SINGLE RUSTICATION LINES

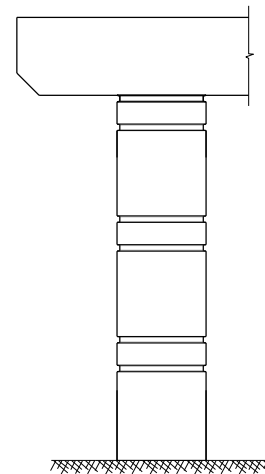

(P2) DOUBLE RUSTICATION LINES

(R2) DOUBLE RUSTICATION LINES.
(SINGLE RUSTICATION LINE ON
32SS PARAPET MAY ALSO BE USED)

DESIGNER NOTES

THE THREE TYPES SHOWN ARE PREFERRED AESTHETIC CONCEPTS FOR WISDOT PROJECTS, WHEN USED WITHOUT STAINING, COSTS ARE INCIDENTAL TO "CONCRETE MASONRY BRIDGES" AND NOT SUBJECT TO CSS FUNDING.

ONLY THE CHOICE OF PARAPET, WING AND PIER DETAILS SHOWN FOR A GIVEN TYPE SHOULD BE USED FOR THAT TYPE.

WINGS PARALLEL TO CENTERLINE OF ABUTMENT (ELEPHANT EAR) ARE TO BE PLAIN (TYPE I).

SEE STANDARDS 4.04 AND 4.05 FOR ADDITIONAL DETAILS.

SEE BRIDGE MANUAL SECTION 4.9 FOR LOCATION OF USE AND RENDERINGS.

AESTHETIC CONCEPTS WITHOUT PEDESTRIAN ACCOMMODATIONS	
	BUREAU OF STRUCTURES
APPROVED: <i>Laura Shadewald</i>	DATE: 7-22