

CORRESPONDENCE/MEMORANDUM _____ *State of Wisconsin*

DATE: 5/14/2020
TO: All WisDOT Standard Sign Plate Holders
FROM: Ryan A. Mayer, P.E.
State Signing Engineer
SUBJECT: Revised WisDOT Standard Sign Plates

Listed below and placed in the Traffic Operations Manuals website are changes and additions to the WisDOT Standard Sign Plates. Please make your coworkers aware of the following changes and that they can be found at: <http://wisconsindot.gov/Pages/doing-bus/local-gov/traffic-ops/manuals-and-standards/manuals.aspx>

Many changes have taken place in this listing. The revisions are as follows:

Sign Plate Additions/Revisions

A3-1	A3-1M	A3-2	A3-3	A4-1	A4-3
A4-3S	A4-6	A4-7A	A4-7B	A4-8	A4-10
A5-2	D7-77A	G20-40	G20-57C	MR1-99	R9-10
R9-11A	R10-30A	R10-72	R10-85	R12-59	W1-13
W8-3	W8-7	W8-9A	W8-11	W8-12	W8-15
W8-17	W11-2	W16-7	W16-9P	W20-1	W20-40
W21-1	W21-1A	W21-2	W21-3	W21-5	W21-6
W21-7	W21-52	W21-60	W21-63	WO8-3	WO8-6A
WO8-6B	WO8-6C	WO8-7	WO8-15	WO8-74	WO8-76
WO8-77	WO11-2				

Retired Sign Plates

A4-7	W8-6A	W8-52	W8-74	W8-76	W08-52
------	-------	-------	-------	-------	--------

If you want to be removed from our distribution list or if your address has changed, please contact Ryan Mayer at the email address or phone number below.

Ryan Mayer
WisDOT Central Office
Bureau of Traffic Operations
3609 Pierstorff St
Madison, WI 53704
(608) 246-3810
ryan.mayer@dot.wi.gov

STANDARD SIGN PLATE LISTING

A1-1	A5-8	A11-17	D4-55A
A1-2	A5-9	A11-18	D4-56
A2-1	A5-10	D1-51	<u>D5-5A</u>
A2-1S	A11-1	D1-55	D5-5B
A3-1	A11-2	D1-56	D5-61
A3-1M	A11-3	D1-57	D5-62
<u>A3-2</u>	A11-4	D1-60	D5-63
A3-3	A11-5	D1-60A	D5-64
A4-1	A11-6	<u>D1-61</u>	D5-65
A4-2	A11-7	<u>D1-63</u>	D5-66
A4-3	A11-8A	<u>D1-64</u>	D5-67
A4-3B	A11-8B	<u>D1-65</u>	D5-68
A4-3S	A11-8C	<u>D1-66</u>	D6-4
A4-4	A11-9	D1-70	D6-4N
A4-5	A11-10	D1-71	D6-4S
A4-6	A11-11A	D1-72	D6-51
A4-7A	A11-11B	<u>D1-80</u>	D6-53
A4-7B	A11-11D	<u>D1-81</u>	D7-51
A4-8	A11-11F	<u>D18-82</u>	D7-53
A4-9	A11-11G	D4-1	D7-54
A4-10	A11-11H	D4-2	D7-56
A4-11	A11-11I	D4-2A	D7-57
A4-12	A11-11J	D4-3	D7-59
A4-14	A11-11K	D4-4	D7-60
A4-15	A11-11L	D4-5A	D7-61
A4-16	A11-12	D4-5	D7-63
A4-17	A11-13	D4-51	D7-64
A4-18	A11-14	D4-52	D7-66
A5-2	A11-15	D4-54	D7-67
A5-3	A11-16	D4-55	D7-68
A5-7			

STANDARD SIGN PLATE LISTING

D7-69	D11-9	E5-52A	E10-56
D7-71	D11-10	E5-53	E10-60
D7-72	D11-10A	E5-54	<u>E10-61</u>
D7-74	D11-10P	E5-54A	E10-62
D7-75	D12-2	E5-56A	E10-63
D7-77	D12-2A	E5-56L	E10-64
D7-77A	D12-2B	E5-57	<u>E10-82</u>
D7-81	D12-3	E5-57D	E10-82A
D7-81A	D12-3A	E5-57E	E10-83
D7-82	D12-5	E5-58	<u>E10-83A</u>
D7-82A	D12-50	E5-60	E11-1
D7-82B	D13-3	E5-61	E13-1P
D7-91	D15-1	E5-62	G20-1
D7-92	D15-2	E5-63	G20-2A
D7-93	D16-1	E5-64	G20-40
D7-95	D17-2	E5-65	G20-51
D9-2	D17-7	E6-51	G20-52
D9-6	D52-53	E6-52	G20-52A
D9-13C	D52-54	E6-53	G20-53
D9-51	D52-58	E6-54A	G20-53A
D9-52	DB5-69	E6-54L	G20-55
D9-52A	DR1-53	E6-54R	G20-56
D9-54	E1-5	E7-1	G20-57
D9-54A	<u>E2-1</u>	E7-2	G20-57B
D10-3	E5-1	E7-3	G20-57C
D11-1	E5-1A	E7-4	<u>G20-58</u>
D11-1A	E5-1B	E9-1	G20-59
D11-6	E5-51	E10-51	G20-60
D11-7	E5-51A	E10-53	G20-61
D11-8	E5-52	E10-54	G20-62
		E10-55	G20-63

STANDARD SIGN PLATE LISTING

G20-64	M1-51	M4-5	MR4-53
G20-65	M1-54	M4-6	MR4-56
G20-66	M1-55	M4-8	MR5-53
G20-67	M1-56	M4-8A	MR5-54
G20-68	M1-56B	M4-9A	R1-1
I2-1	M1-85	<u>M4-9AA</u>	R1-1B
<u>I2-1B</u>	M1-85B	M4-9BA	R1-1F
I2-2	M1-86	M4-9B	R1-2
I2-2R	M1-87	M4-9C	R1-3P
I2-3	M1-88	<u>M4-9CA</u>	R1-5L
I2-3A	M1-88A	<u>M4-9D</u>	R1-5R
I3-1	M1-90	<u>M4-9DA</u>	R1-6
I5-1	M1-91	M4-9R	R1-9
I52-52	M1-92	<u>M4-9RA</u>	R1-10P
I55-56	M1-93	M4-10	R1-53
I55-56B	M1-94	M4-20C	R1-54
I55-57	M1-94H	M4-20L	R1-55
I55-57A	M1-94S	M4-20R	R1-61
I56-50	M1-95	M4-21	R2-1
I57-10	M1-95A	M4-22	R2-4
I57-10W	M1-96	M4-59A	R2-6P
JV-F	M1-97	M4-59L	R3-1
M1-1	M1-98	M5-1	R3-2
M1-4	M2-1	M5-51	R3-3
M1-5A	M3-1	M5-52	R3-4
M1-6	M4-1	M6-1	R3-4A
M1-6B	M4-1A	M6-4	R3-4B
M1-7	M4-2	M6-5	R3-5
M1-8	M4-3	M6-50	R3-5A
M1-8A	M4-4	M7-1	R3-5U
M1-9		M50	
		MR1-99	

STANDARD SIGN PLATE LISTING

R3-5X	R3-51R	R5-2	R7-51
R3-6	R3-52B	R5-2A	R7-52
R3-6T	R3-52C	R5-3	R7-53
R3-6U	R3-52P	R5-6	R7-63
R3-6V	R3-53	R5-50	R7-64
R3-6W	R3-54	R5-51	R7-65
R3-6X	R3-55A	R5-54	R7-66
R3-7	R3-57	R5-57	R8-4
R3-7B	R3-58	R5-57A	R8-7
R3-7C	R3-59	R5-57B	R8-8
R3-7S	R3-60	R5-60	R8-9
R3-8	R3-60X	R5-60RU	R8-10
R3-9B	R4-1	R5-96	R8-51
R3-9C	R4-2	R5-97	R8-52
R3-11D	R4-3	<u>R5-98</u>	R8-53
R3-12G	R4-4	R5-99	R8-54
R3-17	R4-5	R6-1	R8-55
R3-18	R4-7	R6-2	R8-56
R3-20L	R4-9	R6-3	R8-74
R3-20LL	R4-11	R6-4B	R9-1
R3-20R	R4-13	R6-6	R9-2
R3-20RR	R4-14	R6-7	R9-3
R3-25U	R4-18	R7-1	R9-3A
R3-27	R4-50	R7-2	R9-3B
R3-33	R4-52	R7-4	R9-3BL
R3-50	R4-53	R7-5	R9-4
R3-50A	R4-55	R7-6	R9-4A
R3-50U	R4-55S	R7-7	R9-8
R3-51	R5-1	R7-8	R9-9
R3-51L	R5-1A	R7-8A	<u>R9-9A</u>
	R5-1AB	R7-8V	R9-10

STANDARD SIGN PLATE LISTING

R9-11	R10-11S	R11-51	R53-55
R9-11A	R10-11T	R11-52	R53-56
R9-53	R10-12	R11-53	R53-57
R9-55	<u>R10-15L</u>	R11-54F	R55-51
R9-56	<u>R10-15R</u>	R12-1	R55-53
R9-98	R10-16	R12-2	R55-54
R9-99	R10-17A	R12-52	R55-58
R10-1	R10-23	R12-53	R55-58A
R10-2	R10-25	R12-54	R55-59
R10-3	R10-26	R12-55	R55-61
R10-3B	R10-30A	R12-56	R55-61M
R10-3E	R10-50	R12-57	R55-62
R10-3H	R10-61	R12-58	R55-63
R10-3I	R10-62	R12-58F	R55-64
R10-3J	R10-63	<u>R12-59</u>	R55-65
R10-3N	R10-64	R12-70	R55-66
R10-4	R10-64B	R12-70B	R55-67
R10-4B	R10-64F	R13-1	RR2-60
R10-4D	R10-65	R13-49	S1-1
R10-4X	R10-70	R13-50	S1-51
R10-5	R10-71	R14-1	S3-1
R10-6	R10-72	R14-52	S3-51
R10-6B	R10-85	R15-3	S4-2
R10-7	R11-2	R15-50	S4-5
R10-10	R11-2B	R52-55	<u>S4-51</u>
R10-10A	R11-3	R52-57A	<u>S4-52</u>
R10-11	R11-3B	R52-59	S5-2
R10-11B	R11-3C	R53-51	S13-1
R10-11C	R11-4	R53-52	S16-5P
R10-11F	R11-5	R53-53	S16-7

STANDARD SIGN PLATE LISTING

S16-8	W3-3	W5-61	W8-14
S16-9P	W3-4	W5-64	W8-15
S54-61	<u>W3-5</u>	W5-65	W8-16
S57-51	W3-6	W6-1	W8-17
W1-2	W3-8	W6-3	W8-57
W1-3	W4-1	W6-53	W8-58
W1-4	W4-2	W6-54	W8-60
W1-4B	W4-3	W6-54A	W8-61
W1-4C	W4-4A	W6-54B	W8-62
W1-5	W4-4B	W6-54C	W8-63
W1-6	W4-4C	W6-54D	W8-64
W1-7	W4-4P	W6-60	W8-65
W1-8	W4-6	W7-1	W8-66
W1-8B	W4-7	W7-2B	W8-67
W1-10	W5-1	W7-3	W8-68
W1-10F	W5-2	W7-6	W8-69
W1-11	W5-3	W7-61	W8-70
W1-13L	W5-52	W8-1	W8-71
W1-13R	W5-53	W8-1A	W8-72
W1-51	W5-53S	W8-2	W8-72P
W1-60	W5-54	W8-3	W8-73
W2-1	W5-56	W8-4	W8-75
W2-2	W5-57	W8-5	W9-1
W2-3	W5-58D	W8-6	W9-2
W2-6	W5-58L	W8-7	W9-3A
W2-7L	W5-58R	W8-8	W9-62
W2-7R	W5-59L	W8-9	W9-63
W2-50	W5-59R	W8-9A	W10-1
W3-1	W5-60L	W8-11	W10-1A
W3-1B	W5-60R	W8-12	W10-2
W3-2			

STANDARD SIGN PLATE LISTING

W10-3	W13-1	W20-50	W23-2
W10-4	W13-2	W20-50M	W24-1L
W10-5	W13-2A	W20-53	W24-1R
W10-11A	W13-2B	W20-58	W24-1aL
W10-11B	W13-2C	W21-1	W24-1aR
W10-12	W13-2D	W21-1A	W24-1bL
W10-52	W13-3	W21-2	W24-1Br
W11-1	W13-3A	W21-3	W24-1P
W11-2	W13-3B	W21-5	W25-2
W11-4	W13-3C	W21-5A	W54-51
W11-5	W13-3D	W21-5B	W54-52
W11-6	W14-1	W21-6	W54-53
W11-7	W14-2	W21-7	W54-54
W11-8	W14-3	W21-51	W54-55
W11-9	W16-1P	W21-52	W54-56
W11-11	W16-2A	W21-60	W54-57
W11-14	W16-5P	W21-61	W54-58
W11-15	W16-7	W21-62	W54-59
W11-15A	W16-7D	W21-62P	W54-60
W11-50	W16-9P	W21-62Q	W54-62
W11-55	W16-15P	W21-62R	W54-63
W11-57	W19-1	W21-63	W56-51
W11-59P	W19-2	<u>W21-64A</u>	W57-51
W12-1	W20-1	<u>W21-64B</u>	W57-52
W12-1D	W20-2	<u>W21-64C</u>	WO1-1
W12-2	W20-3	W21-66	WO1-2
W12-2A	W20-4	<u>W21-67</u>	WO1-3
W12-50	W20-5	<u>W21-68</u>	WO1-4B
W12-52	W20-7	W22-1	WO1-4
W12-52P	W20-7A	W22-2	WO1-4C
	W20-40	W22-3	

STANDARD SIGN PLATE LISTING

W01-6	W08-6A
W01-7	W08-6B
W03-1	W08-6C
W03-2	W08-7
W03-3	W08-8
W03-4	W08-9
W03-5	W08-15
W04-1	W08-74
W04-2	W08-76
W04-3	W08-77
W04-5	W09-1
W04-5P	W09-2
W05-1	W011-2
W05-2	W012-1
W05-52	W012-1D
W05-53	W013-1
W05-58	W013-2
W05-58D	W016-7
W05-59	W016-9P
W05-60	W024-1
W06-1	W057-51
W06-2	W057-52
W06-3	
W07-61	
W08-1	
W08-1A	
W08-2	
W08-3	
W08-4	
W08-5	
W08-6	

2-POST STEEL POST SELECTION TABLE

		MAXIMUM GROUND LINE TO BOTTOM OF PRINCIPAL SIGN PANEL												SIGN PANEL WIDTH													
		16'	15'	14'	13'	12'	11'	10'	9'	8'	7'	6'	5'	4'	3'	10'-0"	11'-0"	12'-0"	13'-0"	14'-0"	15'-0"	16'-0"	17'-0"	18'-0"	19'-0"	20'-0"	21'-0"
SIGN PANEL HEIGHT	14'	15'	16'	-	-	-	-	-	-	-	-	-	-	-	-	-	-	-	-	-	-	-	-	-	-	-	
	13'	14'	15'	16'	-	-	-	-	-	-	-	-	-	-	W12X26	-	-	-	-	-	-	-	-	-	-	-	-
	12'	13'	14'	15'	16'	-	-	-	-	-	-	-	-	-	W12X26	W12X26	W12X26	-	-	-	-	-	-	-	-	-	-
	11'	12'	13'	14'	15'	16'	-	-	-	-	-	-	-	-	W12X26	W12X26	W12X26	W12X26	-	-	-	-	-	-	-	-	-
	10'	11'	12'	13'	14'	15'	16'	-	-	-	-	-	-	-	W12X26	W12X26	W12X26	W12X26	W12X26	W12X26	-	-	-	-	-	-	-
	9'	10'	11'	12'	13'	14'	15'	16'	-	-	-	-	-	-	W10X22	W12X26	W12X26	W12X26	W12X26	W12X26	W12X26	W12X26	-	-	-	-	-
	8'	9'	10'	11'	12'	13'	14'	15'	16'	16'	16'	16'	16'	16'	W8X21	W10X22	W10X22	W12X26	W12X26	W12X26	W12X26	W12X26	W12X26	W12X26	-	-	
	7'	8'	9'	10'	11'	12'	13'	14'	15'	15'	15'	15'	15'	15'	W8X21	W8X21	W8X21	W10X22	W10X22	W12X26	W12X26	W12X26	W12X26	W12X26	W12X26	-	
	6'	7'	8'	9'	10'	11'	12'	13'	14'	14'	14'	14'	14'	14'	W8X21	W8X21	W8X21	W8X21	W10X22	W10X22	W12X26	W12X26	W12X26	W12X26	W12X26	W12X26	
	5'	6'	7'	8'	9'	10'	11'	12'	13'	13'	13'	13'	13'	13'	W8X18	W8X18	W8X21	W8X21	W10X22	W10X22	W10X22	W12X26	W12X26	W12X26	W12X26	W12X26	
	4'	5'	6'	7'	8'	9'	10'	11'	12'	12'	12'	12'	12'	12'	W6X15	W8X18	W8X18	W8X18	W8X21	W10X22	W10X22	W10X22	W12X26	W12X26	W12X26	W12X26	
	-	4'	5'	6'	7'	8'	9'	10'	11'	11'	11'	11'	11'	11'	W6X15	W6X15	W8X18	W8X18	W8X21	W8X21	W10X22	W10X22	W10X22	W12X26	W12X26	W12X26	
	-	-	4'	5'	6'	7'	8'	9'	10'	10'	10'	10'	10'	10'	W6X15	W6X15	W8X18	W8X18	W8X18	W8X21	W8X21	W10X22	W10X22	W10X22	W12X26	W12X26	
	-	-	-	4'	5'	6'	7'	8'	9'	9'	9'	9'	9'	9'	W6X15	W6X15	W6X15	W8X18	W8X18	W8X18	W8X21	W8X21	W10X22	W10X22	W10X22	W12X26	
	-	-	-	-	4'	5'	6'	7'	8'	8'	8'	8'	8'	8'	W6X15	W6X15	W6X15	W6X15	W6X15	W8X18	W8X18	W8X18	W8X21	W8X21	W10X22	W10X22	
	-	-	-	-	-	4'	5'	6'	7'	7'	7'	7'	7'	7'	W6X15	W6X15	W6X15	W6X15	W6X15	W6X15	W8X18	W8X18	W8X18	W8X21	W8X21	W10X22	
-	-	-	-	-	-	4'	5'	6'	6'	6'	6'	6'	6'	W6X15	W6X15	W6X15	W6X15	W6X15	W6X15	W8X18	W8X18	W8X18	W8X21	W8X21	W10X22		
-	-	-	-	-	-	-	4'	5'	5'	5'	5'	5'	5'	W6X15	W6X15	W6X15	W6X15	W6X15	W6X15	W6X15	W8X18	W8X18	W8X18	W8X21	W8X21		
-	-	-	-	-	-	-	-	4'	4'	4'	4'	4'	4'	W6X15	W6X15	W6X15	W6X15	W6X15	W6X15	W6X15	W6X15	W8X18	W8X18	W8X18	W8X18		

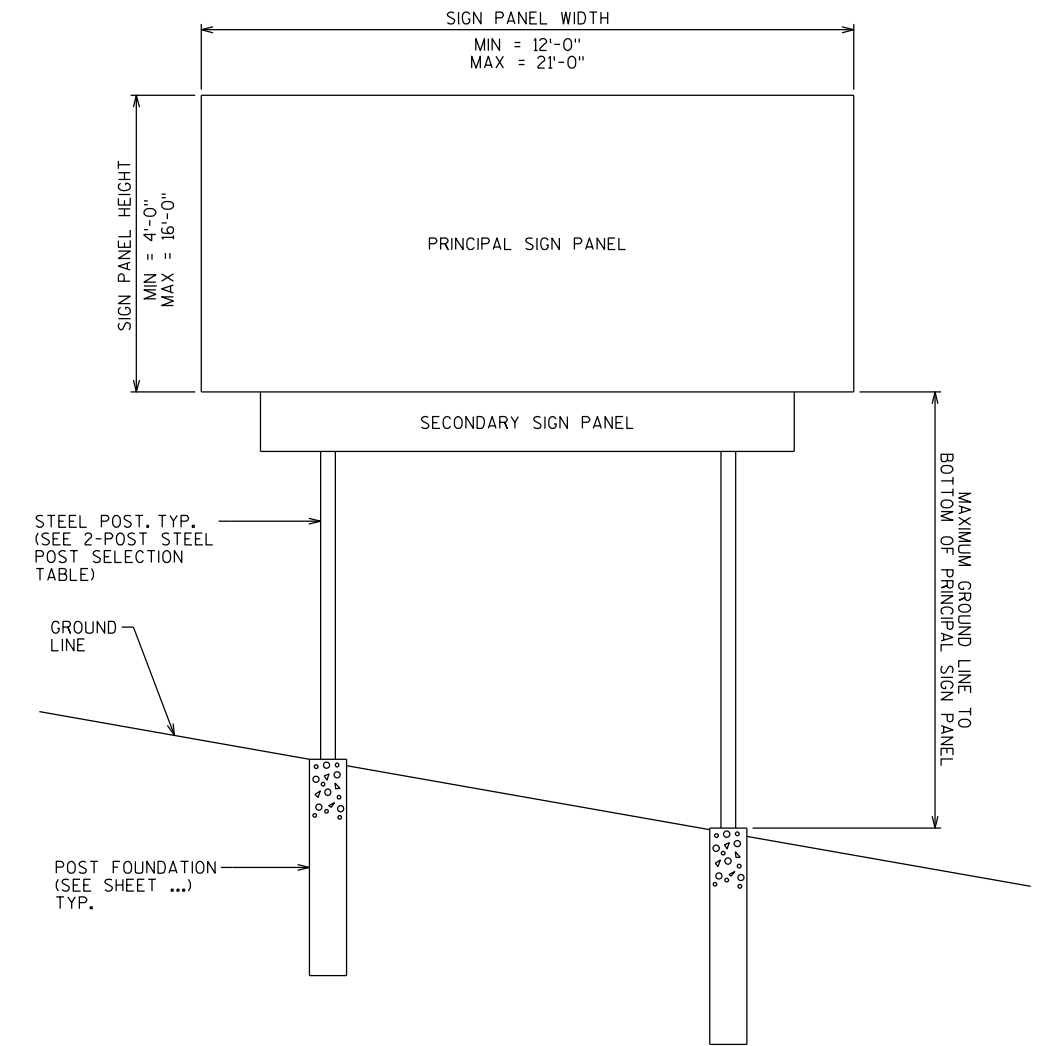

STEEL POST SELECTION NOTES:

USE PROPOSED SIGN PANEL DIMENSIONS AND THE MAXIMUM HEIGHT FROM THE GROUND LINE TO THE BOTTOM OF THE PRINCIPAL SIGN PANEL TO DETERMINE THE MINIMUM REQUIRED STEEL POST SIZE.

"-" INDICATES THAT THERE IS NO STANDARD STEEL POST DESIGN FOR THE PROPOSED SIGN CONFIGURATION. CONTACT THE WISDOT BUREAU OF STRUCTURES TO REQUEST AN ANALYSIS AND DESIGN FOR THE PROPOSED SIGN CONFIGURATION.

IF THE MAXIMUM PROPOSED HEIGHT FROM THE GROUND LINE TO BOTTOM OF SIGN PANEL IS NOT IN A 1-FOOT INCREMENT, SELECT THE MINIMUM REQUIRED STEEL POST SIZE BASED ON THE NEXT LARGEST 1-FOOT INCREMENT. (FOR EXAMPLE, IF THE PROPOSED GROUND LINE TO BOTTOM OF SIGN PANEL HEIGHT IS 14'-2", SELECT THE POST SIZE BASED ON A GROUND LINE TO BOTTOM OF SIGN PANEL HEIGHT OF 15'-0").

IF A PROPOSED SIGN PANEL HEIGHT DIMENSION IS IN A 6" INCREMENT, SELECT THE MINIMUM REQUIRED STEEL POST SIZE THAT FALLS WITHIN THE NEXT LARGEST 1-FOOT INCREMENT. (FOR EXAMPLE, IF THE REQUIRED SIGN PANEL HEIGHT IS 12'-6", SELECT THE POST SIZE BASED ON A SIGN PANEL HEIGHT OF 13'-0")

FOR PROPOSED SIGN CONFIGURATIONS WHERE THE POST HEIGHTS VARY, SELECT THE STEEL POST SIZE BASED ON THE MAXIMUM DIMENSION FROM THE GROUND LINE TO THE BOTTOM OF PRINCIPAL SIGN PANEL. (FOR EXAMPLE, IF THE DIMENSION FROM THE GROUND LINE TO THE BOTTOM OF THE PRINCIPAL SIGN PANEL IS 8- FEET FOR ONE POST AND 10- FEET FOR THE SECOND POST, SELECT THE POST SIZE BASED ON THE 10-FOOT DIMENSION.)

2-POST SIGN CONFIGURATION

NO.	DATE	REVISION	BY
STATE OF WISCONSIN DEPARTMENT OF TRANSPORTATION STRUCTURES DESIGN SECTION			
STRUCTURE BTO TYPE I SIGNS			
		DRAWN BY	PLANS CKD.
2-POST SIGN CONFIGURATION		SHEET A3-2.7	

7

7

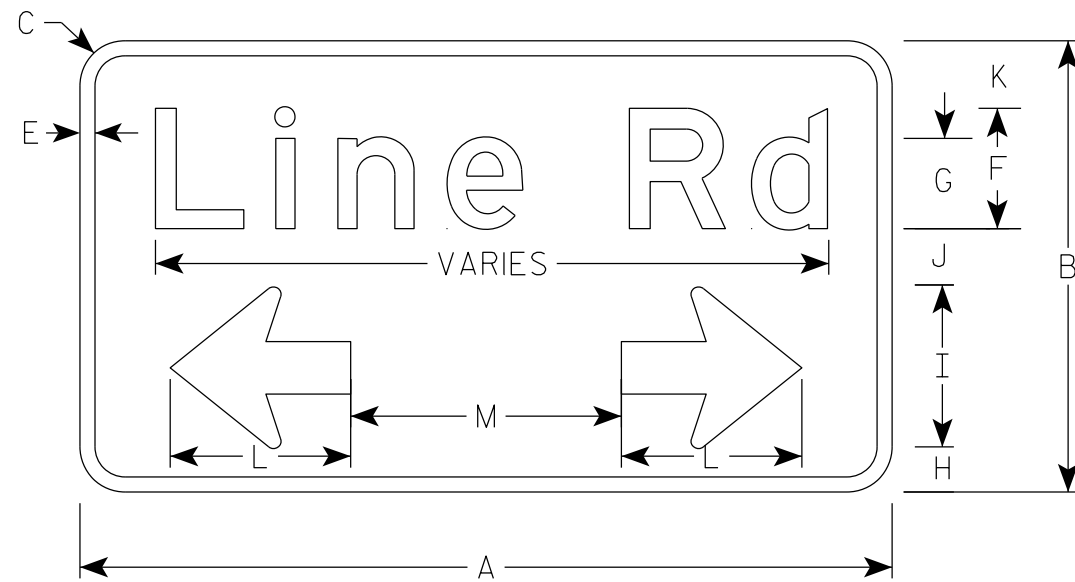
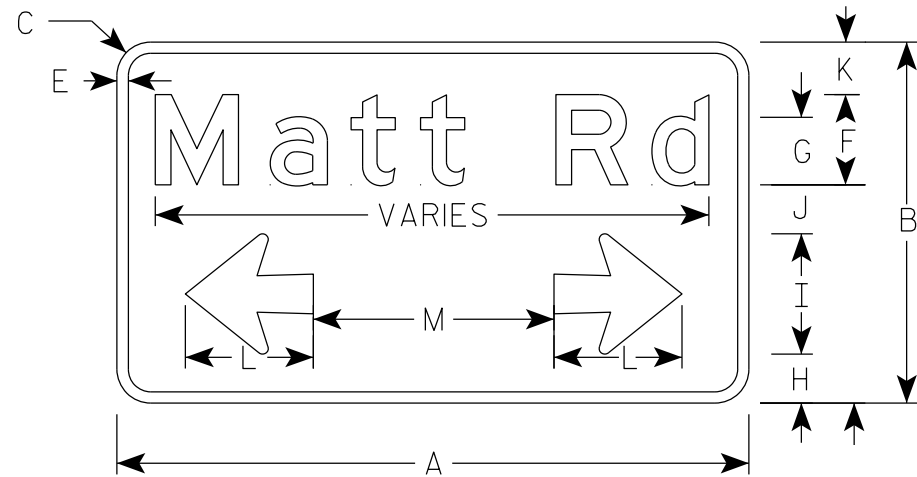

D1-61

NOTES

1. Sign is Type II - Type H Reflective
2. Color:
Background - Green
Message - White
3. Message Series - E
4. Overall length of this sign is in 6" increments.
5. Minimum is 42 inches for width of this sign for size 2.
Minimum is 54 inches for width of this sign for size 3 & 4.
6. Arrows as per standard plate A1-2.

* "M" Minimum dimension is 16 inches for size 2

* "M" Minimum dimension is 18 inches for sizes 3 and 4

7

7

SIZE	A	B	C	D	E	F	G	H	I	J	K	L	M	N	O	P	Q	R	S	T	U	V	W	X	Y	Z	Area sq. ft.
1																											
2	VARIES	24	2 1/4		3/4	6	4 1/2	3 1/4	8	3 1/4	3 1/2	8 1/2	*														Varies
3	VARIES	30	3		1	8	6	3	10 3/4	3 3/4	4 1/2	12	*														Varies
4	VARIES	30	3		1	8	6	3	10 3/4	3 3/4	4 1/2	12	*														Varies
5																											

STANDARD SIGN
D1-61

WISCONSIN DEPT OF TRANSPORTATION

APPROVED *Matthew R. Rauch*
For State Traffic Engineer

DATE 11/5/2020 PLATE NO. D1-61.2

PROJECT NO: _____ HWY: _____ COUNTY: _____ SHEET NO: _____ **E**

NOTES

1. Sign is Type II - Type H Reflective
2. Color:
Background - Green
Message - White
3. Message Series - E
4. Overall length of this sign is in 6" increments.
5. Minimum is 78 inches for width of this sign for size 2.
Minimum is 102 inches for width of this sign for size 3 & 4.

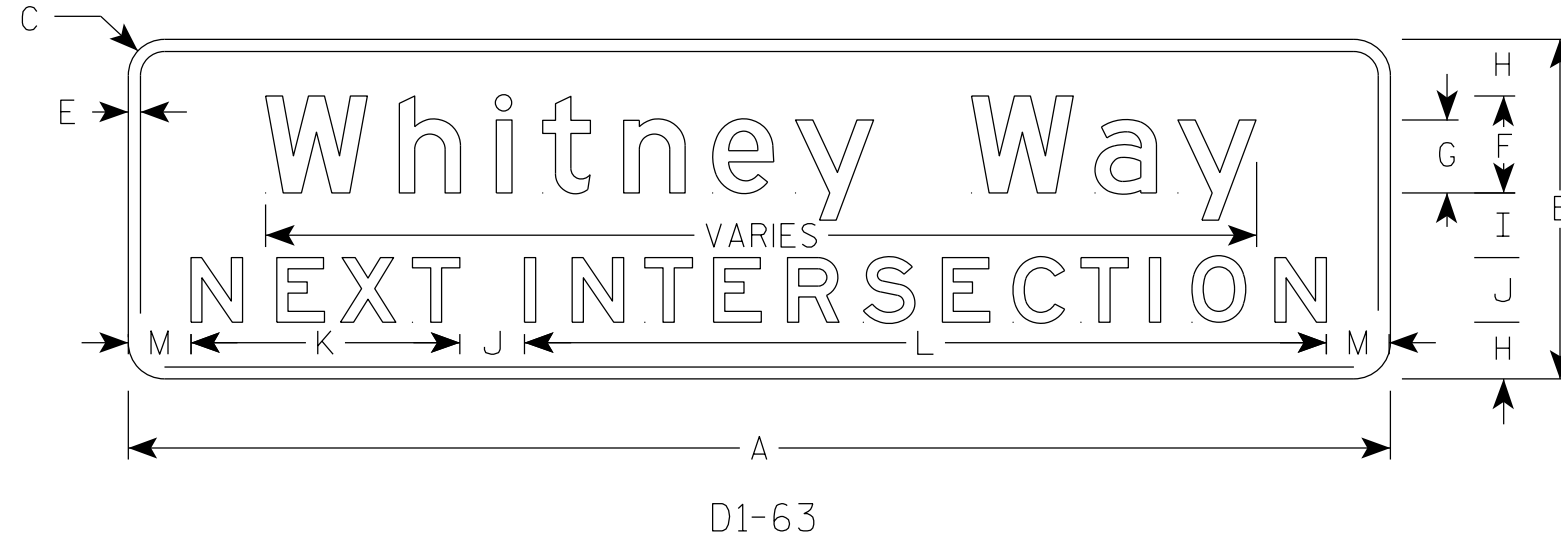

7

7

SIZE	A	B	C	D	E	F	G	H	I	J	K	L	M	N	O	P	Q	R	S	T	U	V	W	X	Y	Z	Area sq. ft.
1																											
2	VARIES	21	2 1/4		3/4	6	4 1/2	3 1/2	4	4	16 5/8	49 5/8	3 7/8														VARIES
3	VARIES	30	3		1	8	6	5 1/2	6	5	20 3/4	61 7/8	7 1/8														VARIES
4	VARIES	30	3		1	8	6	5 1/2	6	5	20 3/4	61 7/8	7 1/8														VARIES
5																											

STANDARD SIGN
D1-63

WISCONSIN DEPT OF TRANSPORTATION

APPROVED *Matthew R. Rauch*
for State Traffic Engineer

DATE 11/5/2020 PLATE NO. D1-63.3

PROJECT NO: _____ HWY: _____ COUNTY: _____ SHEET NO: **E**

NOTES

1. Sign is Type II - Type H Reflective
2. Color:
Background - Green
Message - White
3. Message Series - E
4. Overall length of this sign is in 6" increments.
5. Minimum is 90 inches for width of this sign for size 2.
Minimum is 114 inches for width of this sign for size 3 & 4.

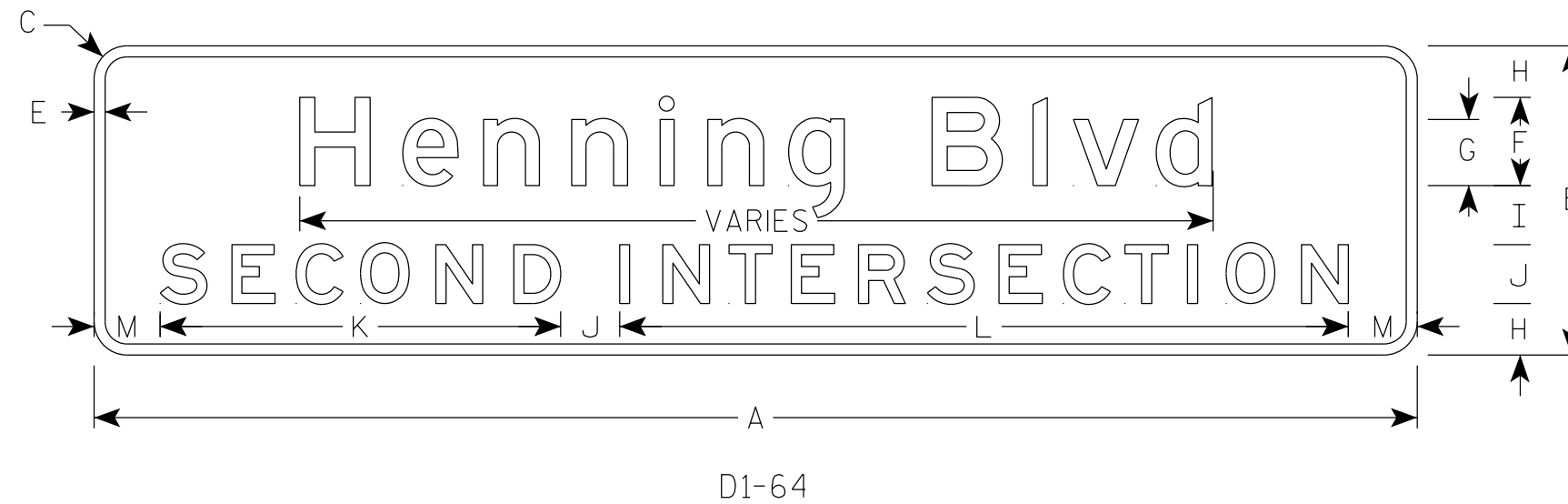

7

7

SIZE	A	B	C	D	E	F	G	H	I	J	K	L	M	N	O	P	Q	R	S	T	U	V	W	X	Y	Z	Area sq. ft.
1																											
2	VARIES	21	2 1/4		3/4	6	4 1/2	3 1/2	4	4	27 1/4	49 5/8	4 5/8														VARIES
3	VARIES	30	3		1	8	6	5 1/2	6	5	34 1/8	61 7/8	6 1/2														VARIES
4	VARIES	30	3		1	8	6	5 1/2	6	5	34 1/8	61 7/8	6 1/2														VARIES
5																											

STANDARD SIGN
D1-64

WISCONSIN DEPT OF TRANSPORTATION

APPROVED *Matthew R. Rauch*
For State Traffic Engineer

DATE 11/5/2020 PLATE NO. D1-64.3

NOTES

1. Sign is Type II - Type H Reflective
2. Color:
Background - Green
Message - White
3. Message Series - E
4. Overall length of this sign is in 6" increments.
5. Minimum is 54 inches for width of this sign for size 2.
Minimum is 72 inches for width of this sign for size 3 & 4.

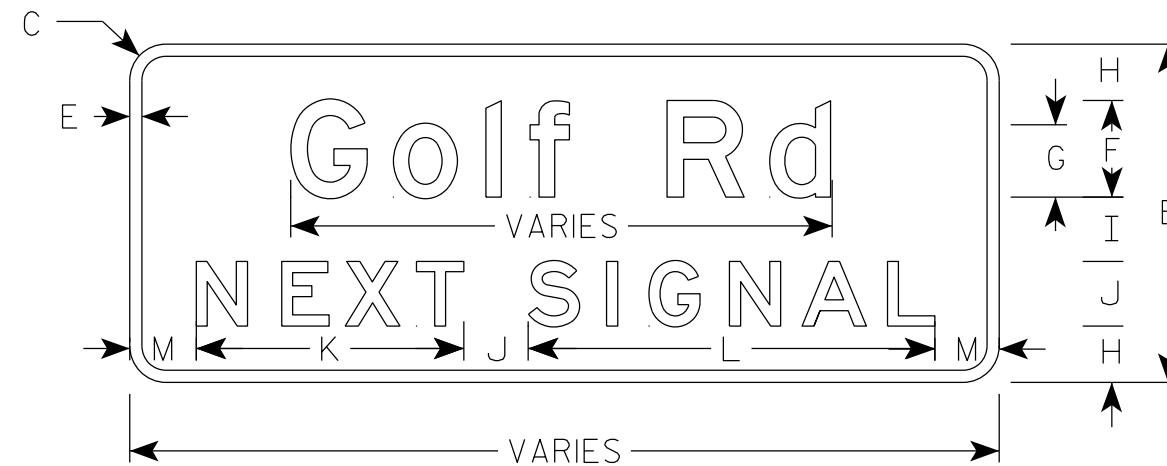

D1-65

7

7

SIZE	A	B	C	D	E	F	G	H	I	J	K	L	M	N	O	P	Q	R	S	T	U	V	W	X	Y	Z	Area sq. ft.
1																											
2	VARIES	21	2 1/4		3/4	6	4 1/2	3 1/2	4	4	16 1/2	25 1/4	4 1/8														VARIES
3	VARIES	30	3		1	8	6	5 1/2	6	5	20 3/4	31 5/8	7 3/8														VARIES
4	VARIES	30	3		1	8	6	5 1/2	6	5	20 3/4	31 1/2	7 3/8														VARIES
5																											

STANDARD SIGN
D1-65

WISCONSIN DEPT OF TRANSPORTATION

APPROVED *Matthew R. Rauch*
for State Traffic Engineer

DATE 11/5/2020 PLATE NO. D1-65.3

PROJECT NO: _____ HWY: _____ COUNTY: _____ SHEET NO: **E**

NOTES

1. Sign is Type II - Type H Reflective
2. Color:
Background - GREEN
Message - WHITE
3. Message Series - E except as shown

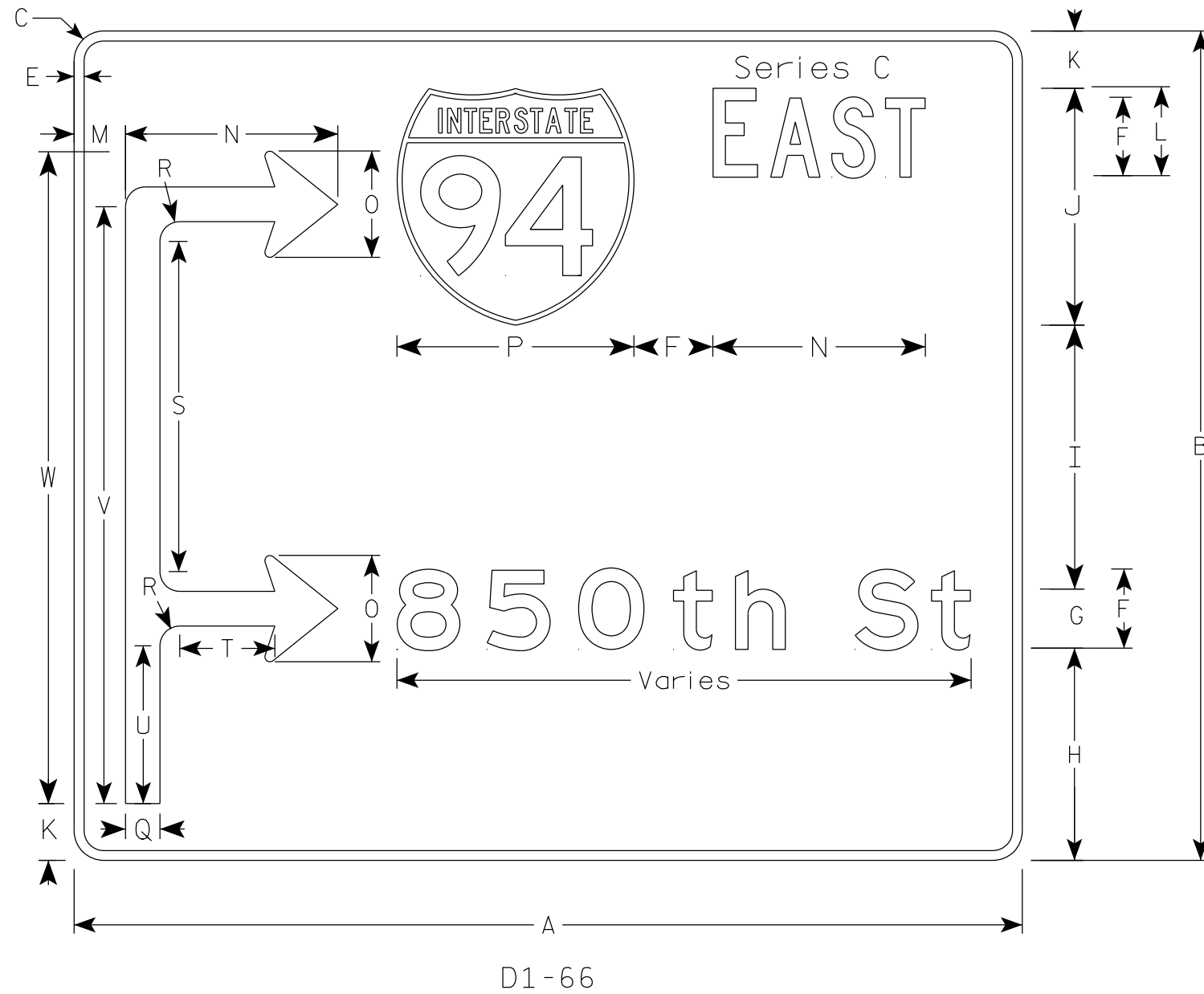

SIZE	A	B	C	D	E	F	G	H	I	J	K	L	M	N	O	P	Q	R	S	T	U	V	W	X	Y	Z	Area sq. ft.
1																											
2	VARIES	84	3		1	8	6	21 1/2	26 3/4	24	5 3/4	9	5 1/4	21 1/2	10 3/4	24	3 1/2	2	33 1/2	9 5/8	16	60 1/2	66				VARIES
3																											
4																											
5																											

STANDARD SIGN
D1-66

WISCONSIN DEPT OF TRANSPORTATION

APPROVED *Matthew R. Rauch*
for State Traffic Engineer

DATE 11/5/2020 PLATE NO. D1-66.2

NOTES

1. All Signs Type II - Type H Reflective
2. Color:
Background - Green
Message - White
3. Message Series - C except as Shown

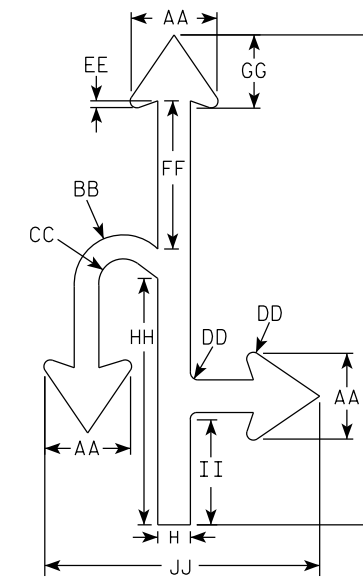
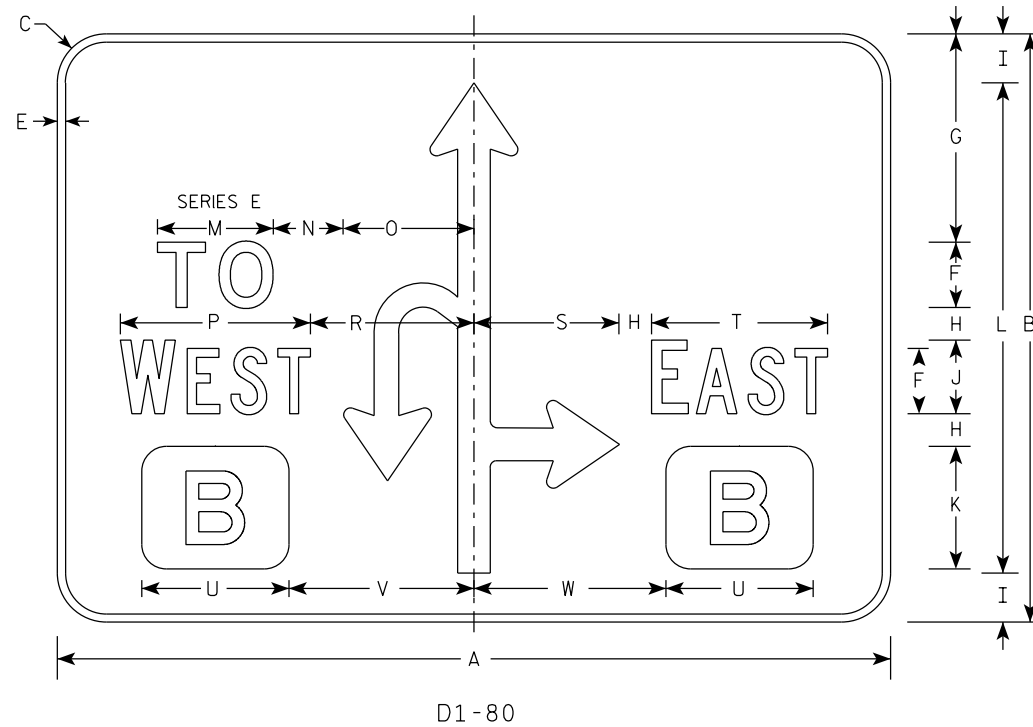

Arrow Detail

SIZE	A	B	C	D	E	F	G	H	I	J	K	L	M	N	O	P	Q	R	S	T	U	V	W	X	Y	Z	Area sq. ft.
1																											
2																											
3	102	72	6		1	8	19	4	6	9	15	60	14 1/8	8 5/8	16	23 1/4		20	17 3/4	21 1/2	18	22 5/8	23 1/2			51.0	
4	114	72	6		1	8	10	4	6	9	20	60	14 1/8	12 7/8	15 7/8	23 1/4		24 1/4	27 7/8	21 1/2	24	23 7/8	25 7/8			57.0	
5																											

SIZE	AA	BB	CC	DD	EE	FF	GG	HH	II	JJ
1										
2										
3	10 1/2	6	3	7/8	3/4	18 1/8	9	30 1/8	12 7/8	33 5/8
4	10 1/2	6	3	7/8	3/4	18 1/8	9	30 1/8	12 7/8	33 5/8
5										

STANDARD SIGN
D1-80

WISCONSIN DEPT OF TRANSPORTATION

APPROVED *Matthew R. Rauch*
for State Traffic Engineer

DATE 12/9/2020 PLATE NO. D1-80.1

PROJECT NO: _____ HWY: _____ COUNTY: _____ SHEET NO: _____ **E**

NOTES

1. All Signs Type II - Type H Reflective
2. Color:
Background - Green
Message - White
3. Message Series - E except as noted

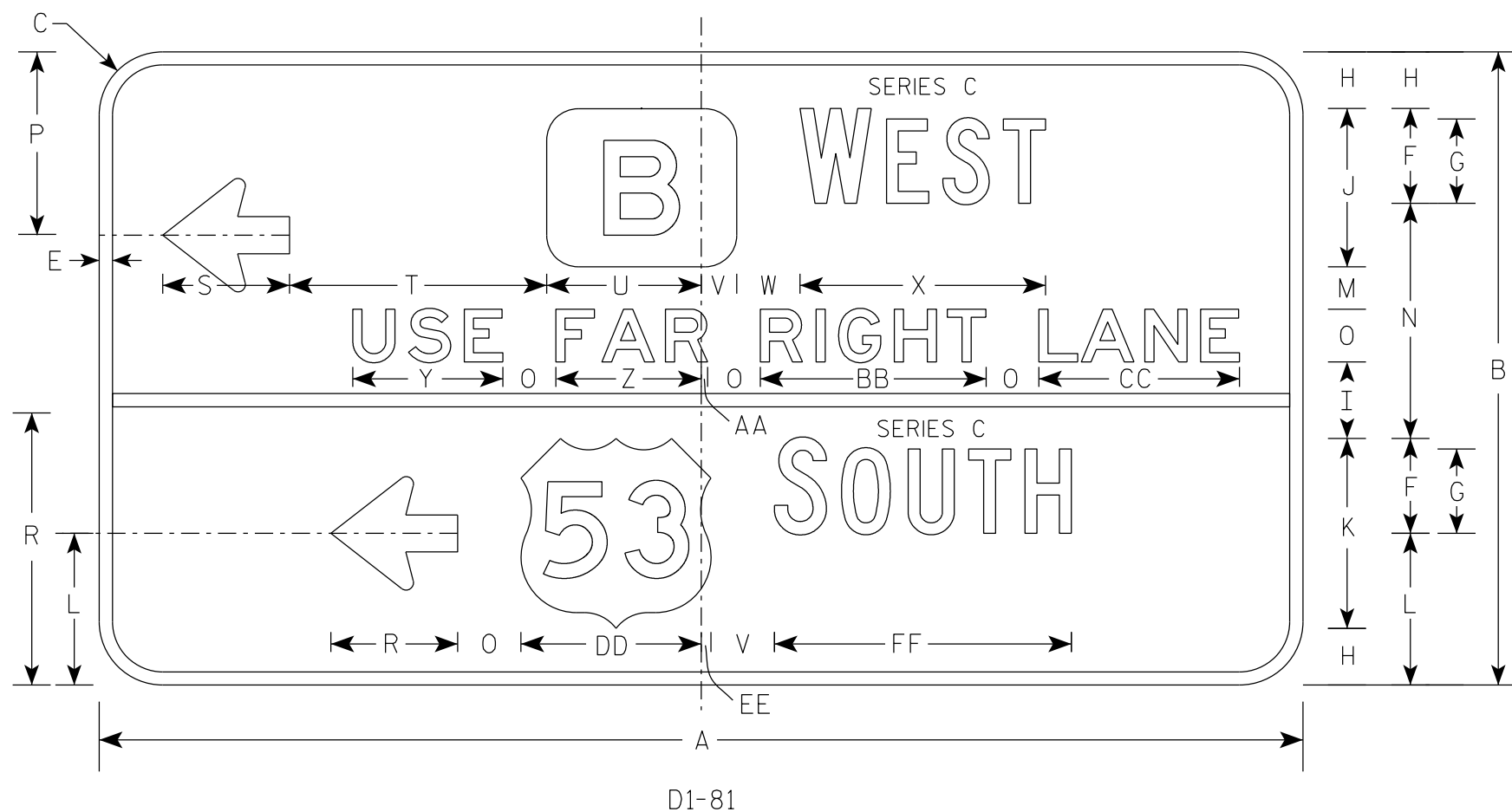

7

SIZE	A	B	C	D	E	F	G	H	I	J	K	L	M	N	O	P	Q	R	S	T	U	V	W	X	Y	Z	Area sq. ft.
1																											
2																											
3	114	60	6		1 1/4	9	8	5 3/8	7 1/4	15	18	14 3/8	4	22 1/4	5	17 1/4		25 3/4	12	24 3/8	14 5/8	3 3/8	6	23 1/4	14 1/4	13 3/4	47.5
4																											
5																											

SIZE	AA	BB	CC	DD	EE	FF
1						
2						
3	5/8	21 3/8	19	17	1	28 1/8
4						
5						

STANDARD SIGN
D1-81

WISCONSIN DEPT OF TRANSPORTATION

APPROVED *Matthew R Rauch*
For State Traffic Engineer

DATE 12/9/2020 PLATE NO. D1-81.1

PROJECT NO: _____ HWY: _____ COUNTY: _____ SHEET NO: **E**

7

NOTES

1. All Signs Type II - Type H Reflective
2. Color:
Background - Green
Message - White
3. Message Series - E except as noted

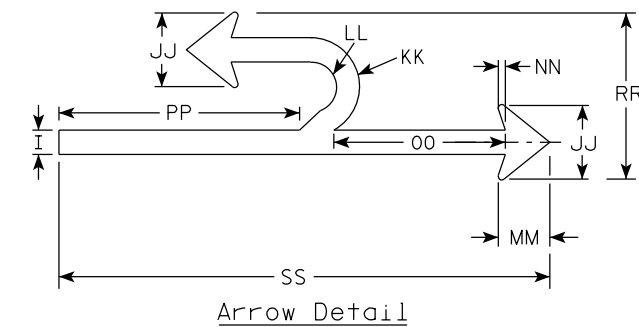
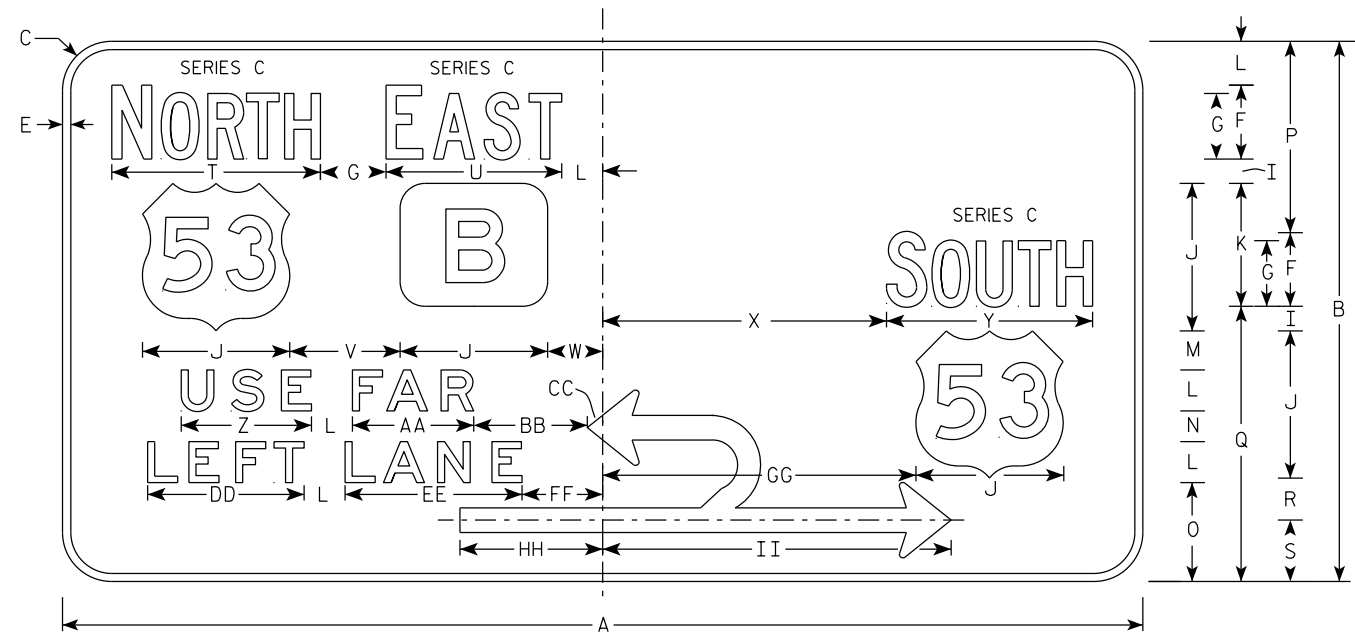

D1-82

SIZE	A	B	C	D	E	F	G	H	I	J	K	L	M	N	O	P	Q	R	S	T	U	V	W	X	Y	Z	Area sq. ft.
1																											
2																											
3	132	66	6		1	9	8	6 3/4	3	18	15	5	4 3/4	3 3/4	12 1/8	23 3/8	33 5/8	5 1/8	7 1/2	25 1/8	21 1/2	13 1/2	6 3/4	34 5/8	25 1/8	16	60.5
4																											
5																											

SIZE	AA	BB	CC	DD	EE	FF	GG	HH	II	JJ	KK	LL	MM	NN	OO	PP	QQ	RR	SS
1																			
2																			
3	14 7/8	13 7/8	1 7/8	19 1/8	21 5/8	9 7/8	38 1/4	17 1/2	42 1/2	9	6	3	6 3/8	7/8	20 7/8	29 3/8		20 3/8	60
4																			
5																			

STANDARD SIGN
D1-82

WISCONSIN DEPT OF TRANSPORTATION

APPROVED *Matthew R Rauch*
For State Traffic Engineer

DATE 12/9/2020 PLATE NO. D1-82.1

PROJECT NO: _____ HWY: _____ COUNTY: _____ SHEET NO: **E**

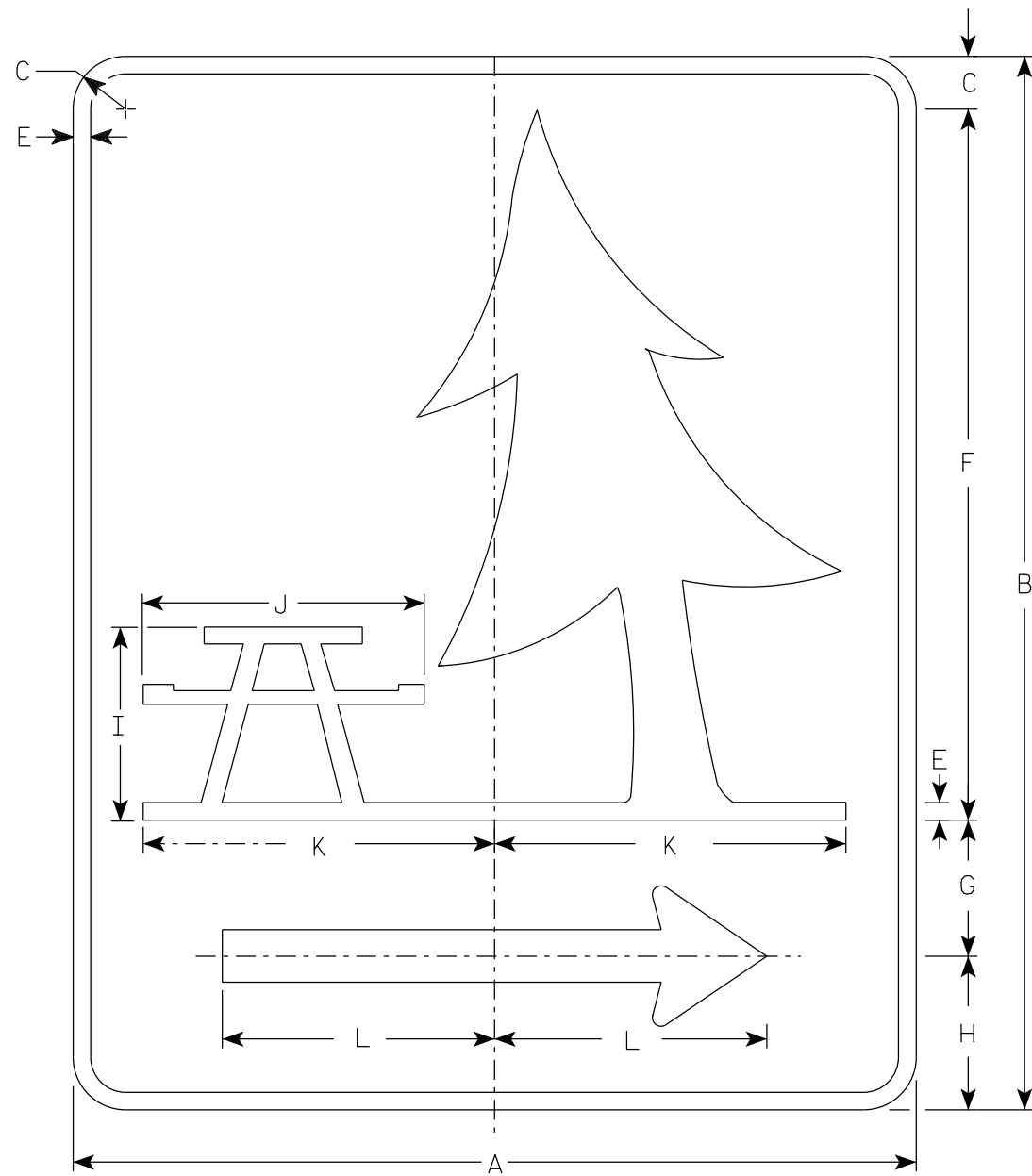

D5-5AR

NOTES

1. Sign is Type II - Type H Reflective
2. Color:
Background - Blue
Message - White
3. D5-5AL is the same as D5-5AR except the arrow is reversed.

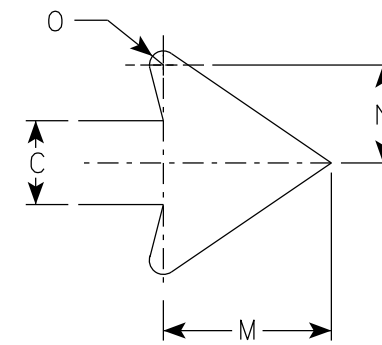

Arrow Detail

7

7

SIZE	A	B	C	D	E	F	G	H	I	J	K	L	M	N	O	P	Q	R	S	T	U	V	W	X	Y	Z	Area sq. ft.
1	24	30	1 1/2		1/2	20 1/4	3 7/8	4 3/8	5 1/2	8	10	7 3/4	3	1 3/4	3/4												5.0
2	24	30	1 1/2		1/2	20 1/4	3 7/8	4 3/8	5 1/2	8	10	7 3/4	3	1 3/4	3/4												5.0
3																											
4																											
5																											

STANDARD SIGN
D5-5A

WISCONSIN DEPT OF TRANSPORTATION

APPROVED *Matthew R. Rauch*
For State Traffic Engineer

DATE 08/27/2020 PLATE NO. D5-5A.7

NOTES

1. Signs are Type I - Type SH Reflective
2. Color:
Background - Green
Message - White
3. Message Series - E
4. Substitute appropriate numerals and adjust spacing as required to achieve proper balance.
5. Use appropriate sign in conjunction with E1-1A. Width varies per sign

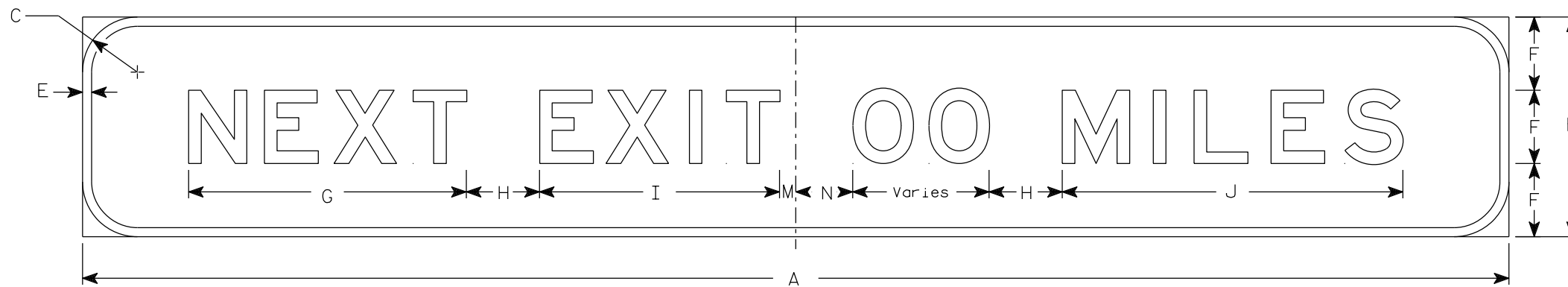

E2-1 *For use with E1-1A, 13' wide or wider. Sign width must match with of E1-1A.

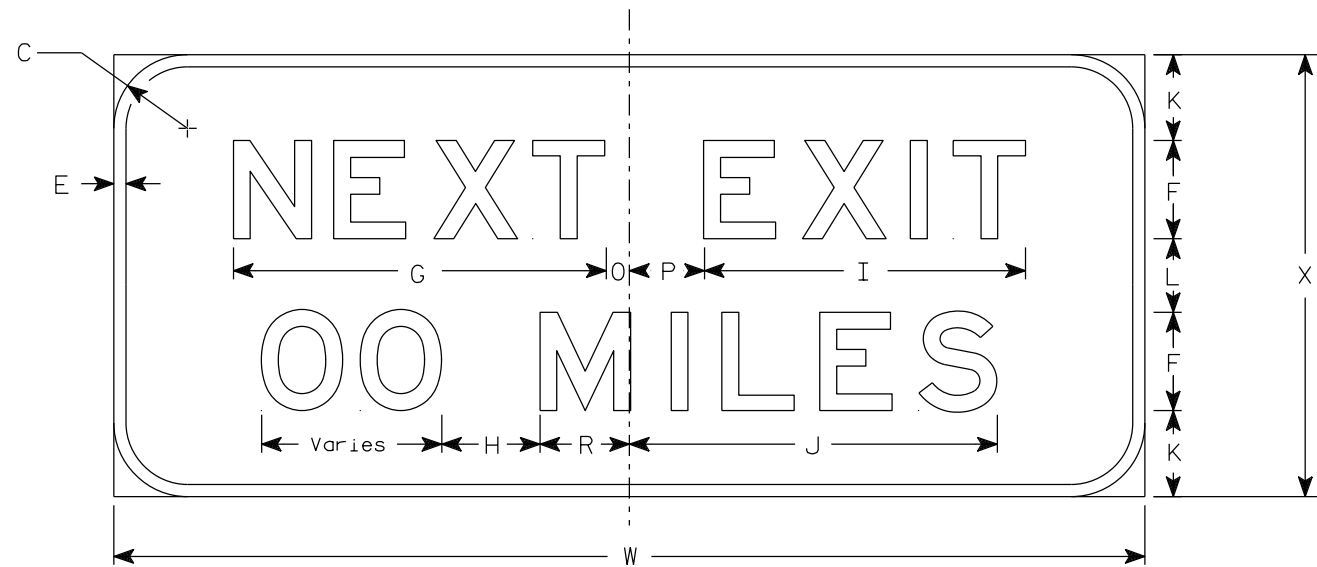

E2-1A *For use with E1-1A, under 13'in width.

SIZE	A	B	C	D	E	F	G	H	I	J	K	L	M	N	O	P	Q	R	S	T	U	V	W	X	E2-1 E2-1A		
																									Area sq. ft.	Area sq. ft.	
1																											
2																											
3																											
4	varies	24	6		1	8	30 3/8	8	26 1/4	30	7	6	1 3/4	6 1/4	1 7/8	6 1/8		7 1/4					84	36	varies	21.0	
5	varies	24	6		1	8	30 3/8	8	26 1/4	30	7	6	1 3/4	6 1/4	1 7/8	6 1/8		7 1/4					84	36	varies	21.0	

STANDARD SIGN
E2-1 & E2-1A

WISCONSIN DEPT OF TRANSPORTATION

APPROVED *Matthew R. Rauch*
For State Traffic Engineer

DATE 7/28/2020 PLATE NO. E2-1.6

PROJECT NO: _____ HWY: _____ COUNTY: _____ SHEET NO: **E**

NOTES

1. Sign is Type I - Type SH Reflective
2. Color:
Background - Blue
Message - White
3. Message Series - E
4. Apply proper Exit Numbers and letters, optically center to adjust spacing to achieve proper balance.

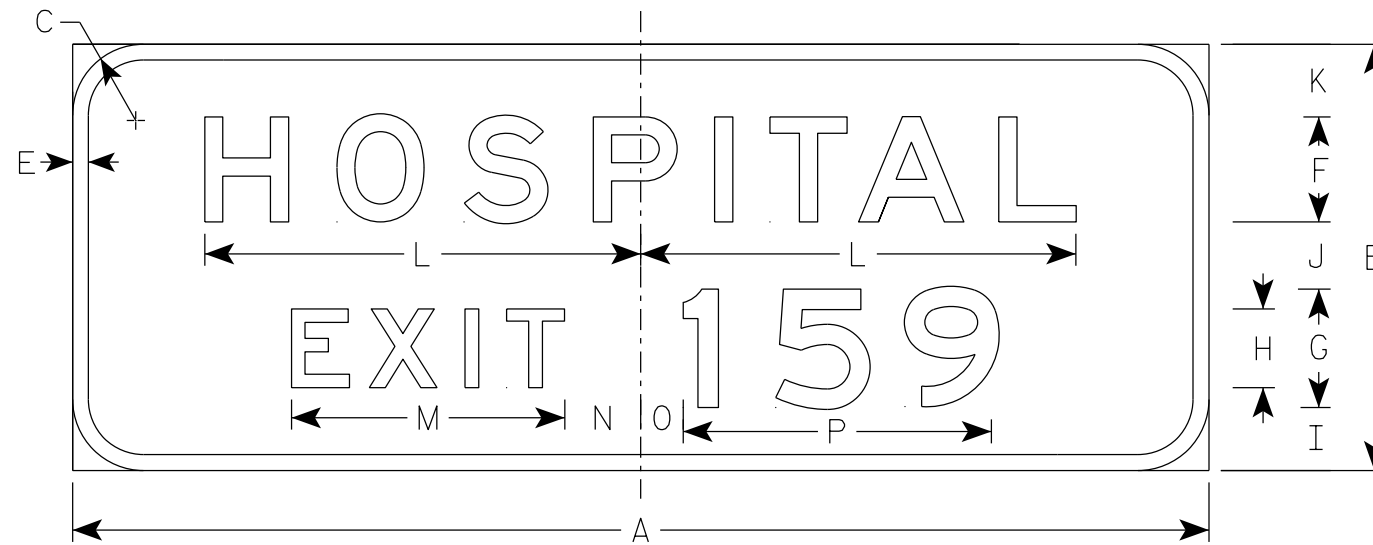

E10-61

SIZE	A	B	C	D	E	F	G	H	I	J	K	L	M	N	O	P	Q	R	S	T	U	V	W	X	Y	Z	Area sq. ft.
1																											
2																											
3																											
4	144	54	9		2	13 3/8	15	10	8	8 1/2	9 1/4	55 1/4	34 5/8	9 5/8	5 3/8	39											54.0
5	144	54	9		2	13 3/8	15	10	8	8 1/2	9 1/4	55 1/4	34 5/8	9 5/8	5 3/8	39											54.0

TYPICAL SIGNS
E10-61

WISCONSIN DEPT OF TRANSPORTATION

APPROVED *Matthew R. Rauch*
For State Traffic Engineer

DATE 11/5/2020 PLATE NO. E10-61.4

PROJECT NO: _____ HWY: _____ COUNTY: _____ SHEET NO: **E**

RURAL LOCATIONS

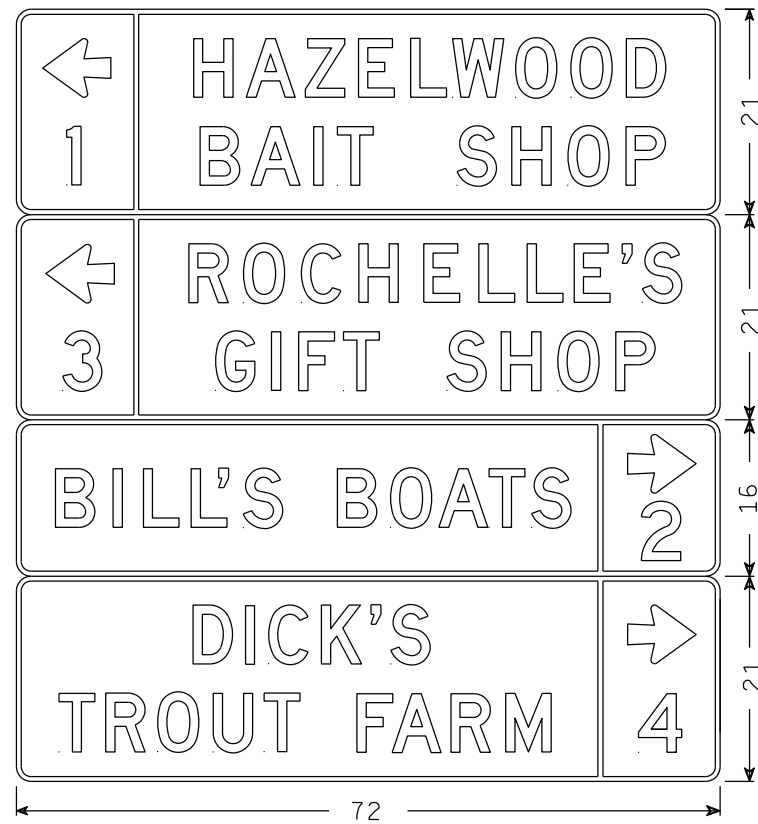

URBAN LOCATIONS



NOTES

1. All Signs Type II - Type H Reflective
2. Color:
Background - Blue
Message - White
3. Message Series - D
4. Corners and borders shall be rounded as shown.
5. Mileage shall be shown in whole number increments, unless distance is less than 1 mile, then number shall be shown in decimals.

Both 6" and 4" Series D copy allow approximately 10 letters/characters per message line. The message shall be optically balanced about the centerline of the sign.

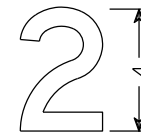
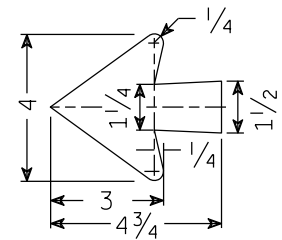
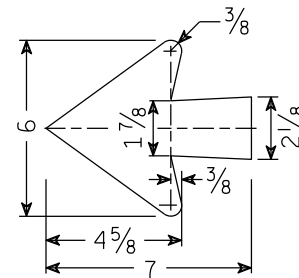
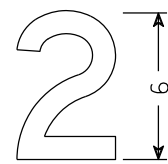

APOSTROPHE DETAIL FOR
6" Copy 4" Copy

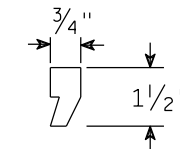
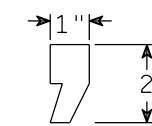

7

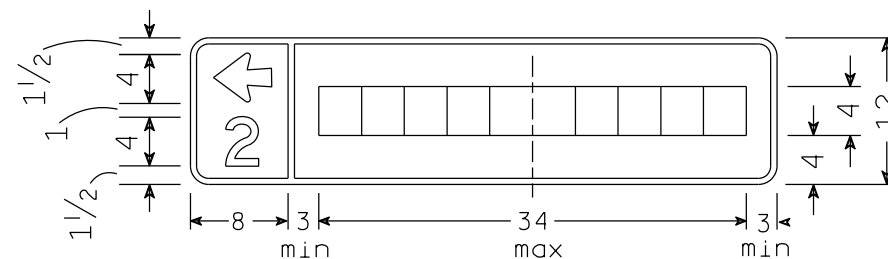
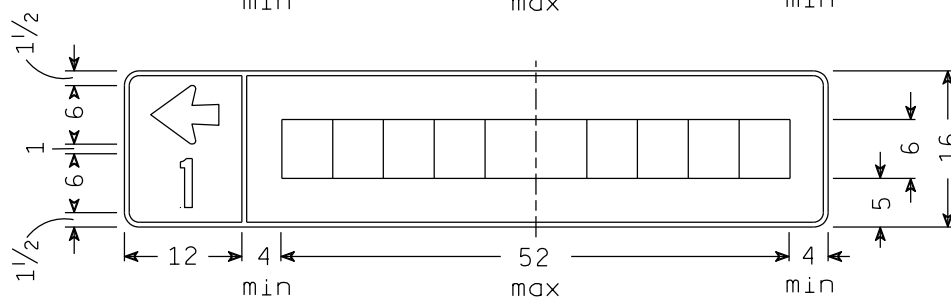
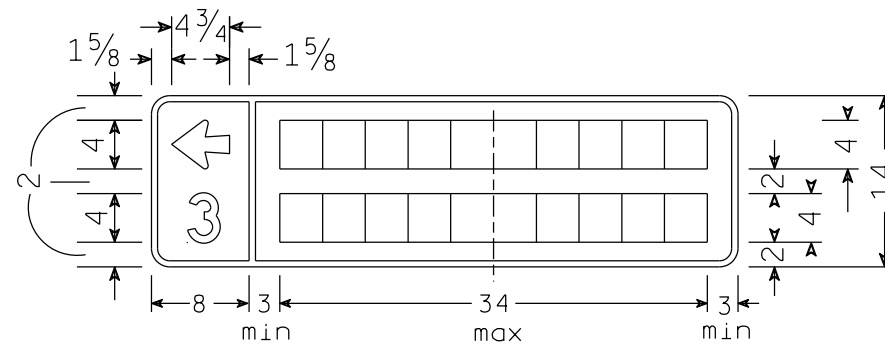
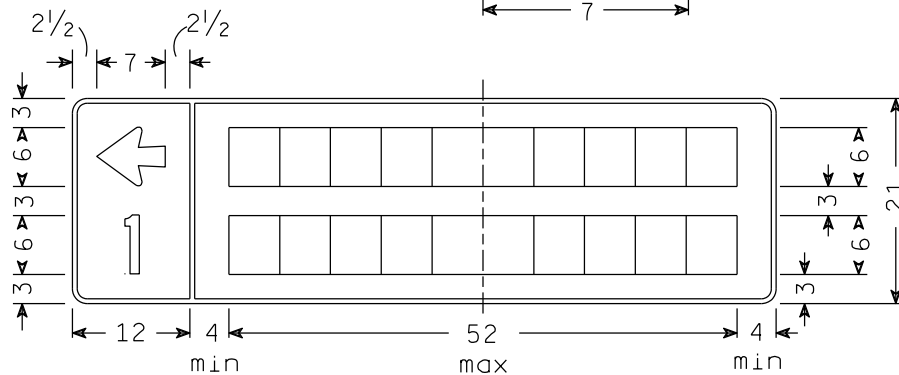

7

STANDARD SIGN
E10-82

WISCONSIN DEPT OF TRANSPORTATION

APPROVED *Matthew R Rauch*
for State Traffic Engineer

DATE 10/29/2020 PLATE NO. E10-82.6

NOTES

1. All Signs Type II - Non-Reflective
2. Color:
Background - Black
Message - White
3. Message Series - B 4 1/2 inch
4. Maximum of 21 letters on 6 foot board and 9 letters on 42 inch board
5. All sign panels shall have a 1/2 inch border with a 1 1/4 inch radius.

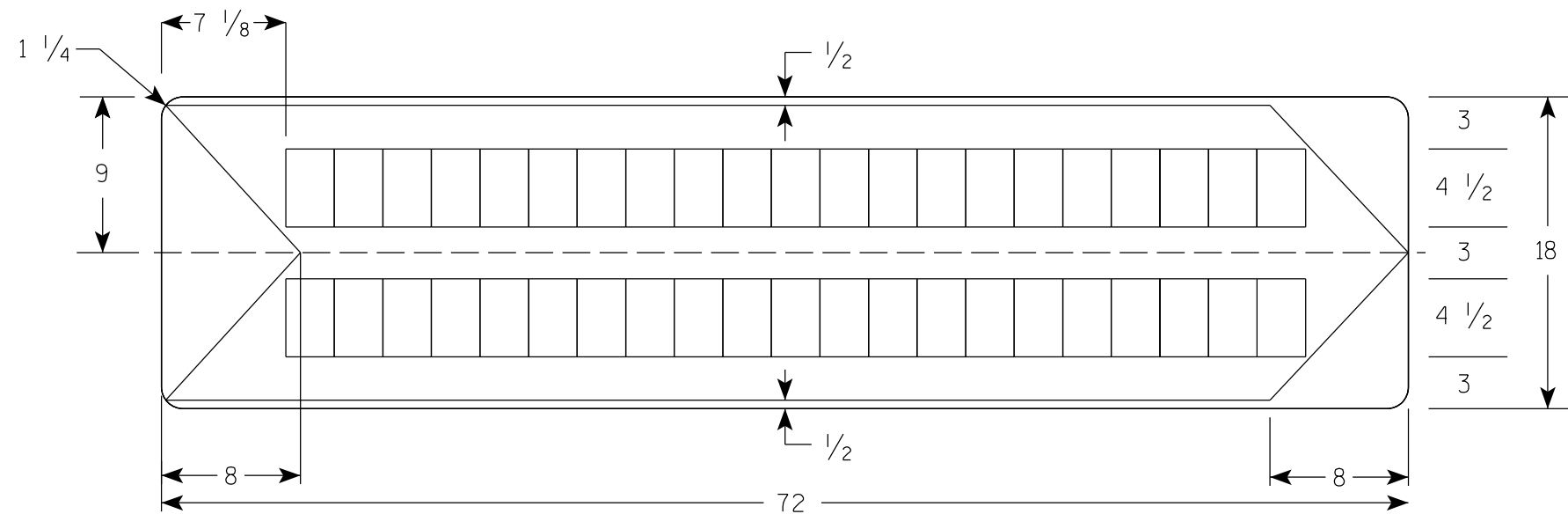

E10-83A

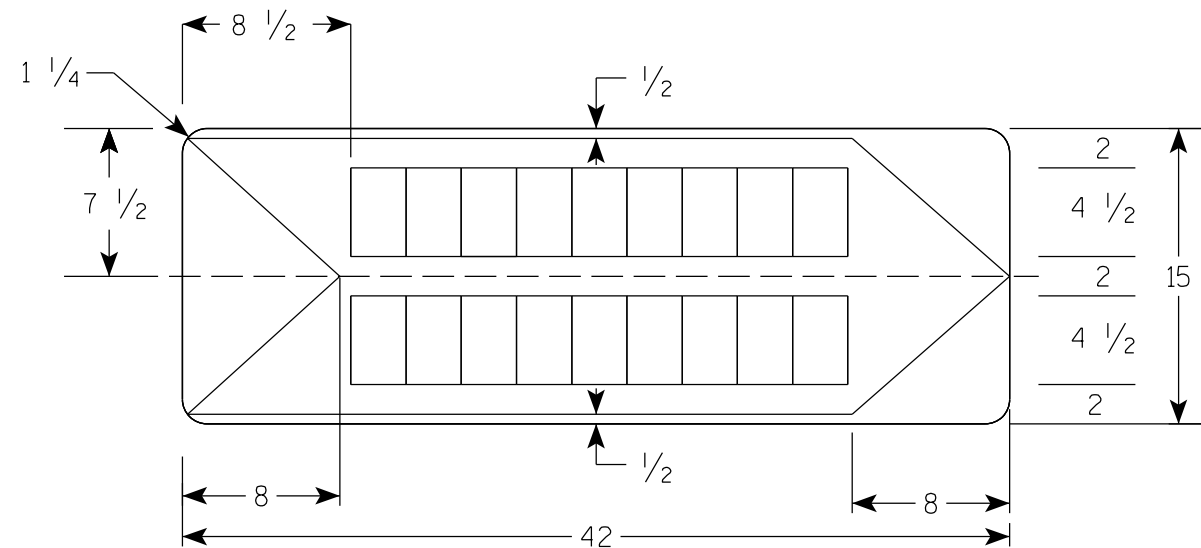

E10-83B

STANDARD SIGN E10-83A & E10-83B	
WISCONSIN DEPT OF TRANSPORTATION	
APPROVED	<i>Matthew R. Rauch</i> for State Traffic Engineer
DATE 12/10/2020	PLATE NO. E10-83A.1

NOTES

1. Sign is Type II- Type F Reflective
2. Color:
Background - Orange
Message - Black
3. Message Series - D

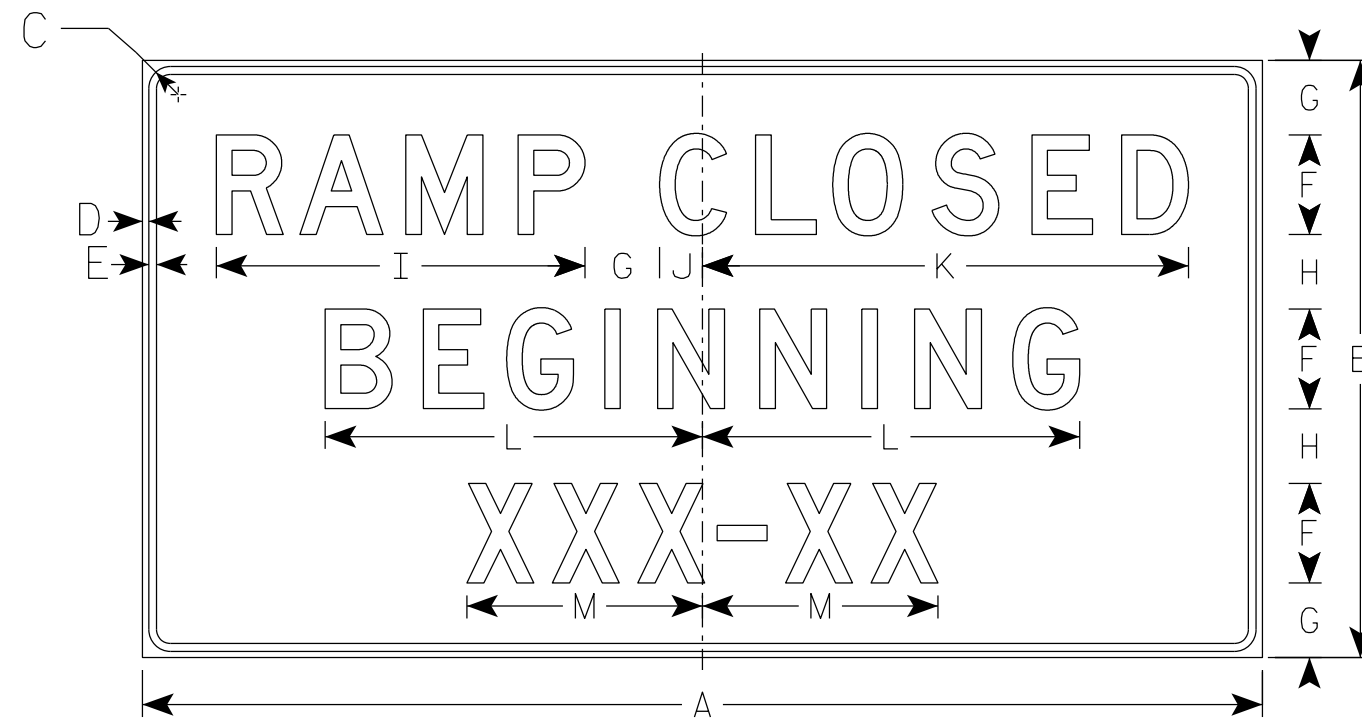

G20-58

SIZE	A	B	C	D	E	F	G	H	I	J	K	L	M	N	O	P	Q	R	S	T	U	V	W	X	Y	Z	Area sq. ft.
1																											
2	72	36	1 5/8	5/8	3/4	6	5	4	22 1/4	2 3/8	29 1/2	22 3/4	14 1/4														18.0
3	90	48	1 5/8	5/8	3/4	8	6	6	29 5/8	3 3/8	39	30 3/8	19														30.0
4																											
5																											

STANDARD SIGN
G20-58

WISCONSIN DEPT OF TRANSPORTATION

APPROVED *Matthew R. Raub*
for State Traffic Engineer

DATE 10/19/2020 PLATE NO. G20-58.2

PROJECT NO: _____ HWY: _____ COUNTY: _____ SHEET NO: **E**

7

7

NOTES

1. Sign is Type II - Type H Reflective
2. Color:
Background - Blue
Message - White except as noted
3. Message Series - C

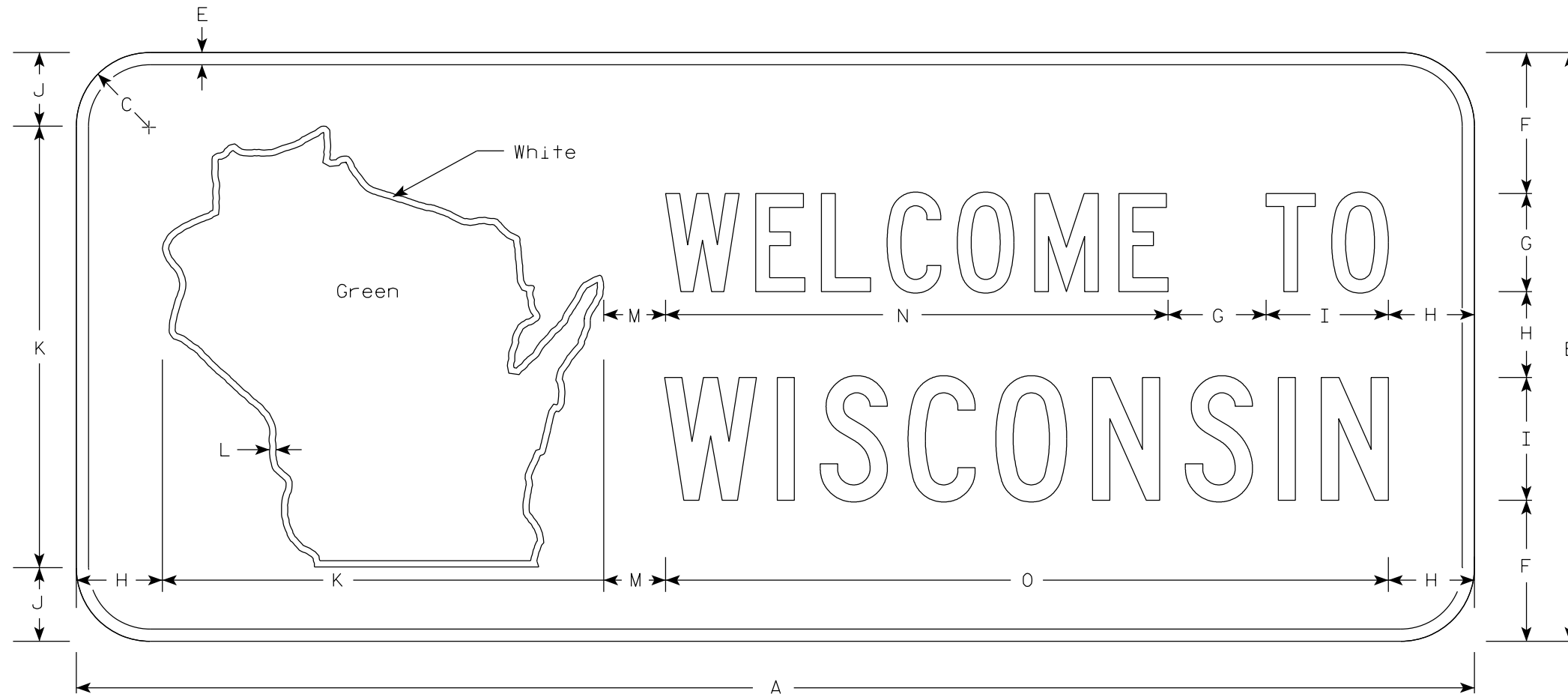

I2-1B

SIZE	A	B	C	D	E	F	G	H	I	J	K	L	M	N	O	P	Q	R	S	T	U	V	W	X	Y	Z	Area sq. ft.
1																											
2	114	48	6		1	11 1/2	8	7	10	6	36	1/2	5	41	59												38.0
3																											
4																											
5																											

STANDARD SIGN
I2-1B

WISCONSIN DEPT OF TRANSPORTATION

APPROVED *Matthew R. Rauch*
For State Traffic Engineer

DATE 11/16/2020 PLATE NO. I2-1B.5

PROJECT NO: _____ HWY: _____ COUNTY: _____ SHEET NO: **E**

NOTES

1. Sign is Type II - Type F Reflective
2. Color:
Background - Orange
Message - Black
3. Message Series - D
4. Corners may be square or rounded when base material is plywood but borders shall be rounded as shown. When base material is metal, the corners and borders shall be rounded.

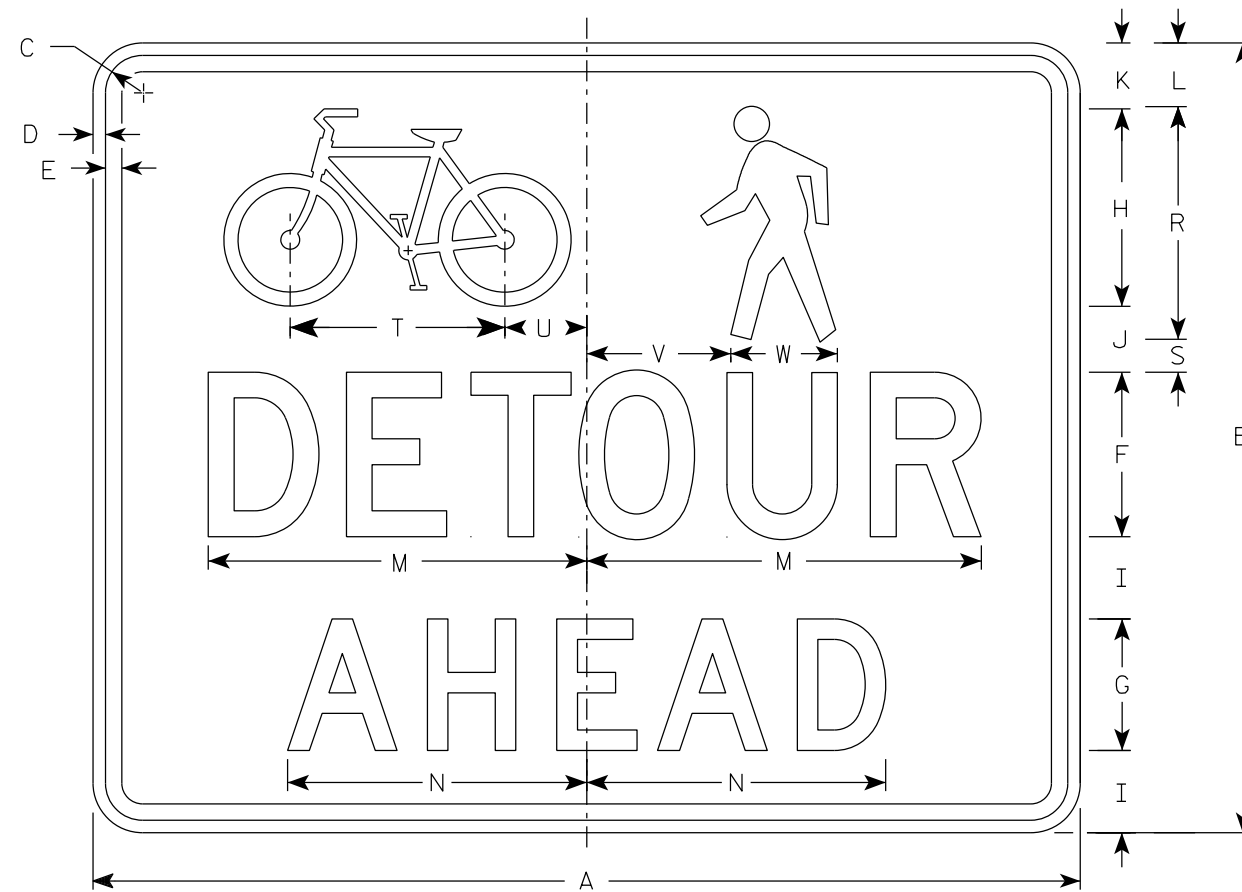

M4-9AA

SIZE	A	B	C	D	E	F	G	H	I	J	K	L	M	N	O	P	Q	R	S	T	U	V	W	X	Y	Z	Area sq. ft.
1																											
2	30	24	1 1/8	3/8	1/2	5	4	6	2 1/2	2	2	1 7/8	11 3/4	9 1/8				7 1/8	1	6 1/2	2 1/2	4 3/8	3 1/4				5.00
3																											
4																											
5																											

STANDARD SIGN
M4-9AA

WISCONSIN DEPT OF TRANSPORTATION

APPROVED *Matthew R Rauch*
For State Traffic Engineer

DATE 7/7/2020 PLATE NO. M4-9AA.1

PROJECT NO: _____ HWY: _____ COUNTY: _____ SHEET NO: **E**

NOTES

1. Sign is Type II - Type F Reflective
2. Color:
Background - Orange
Message - Black
3. Message Series - D
4. Corners may be square or rounded when base material is plywood but borders shall be rounded as shown. When base material is metal, the corners and borders shall be rounded.

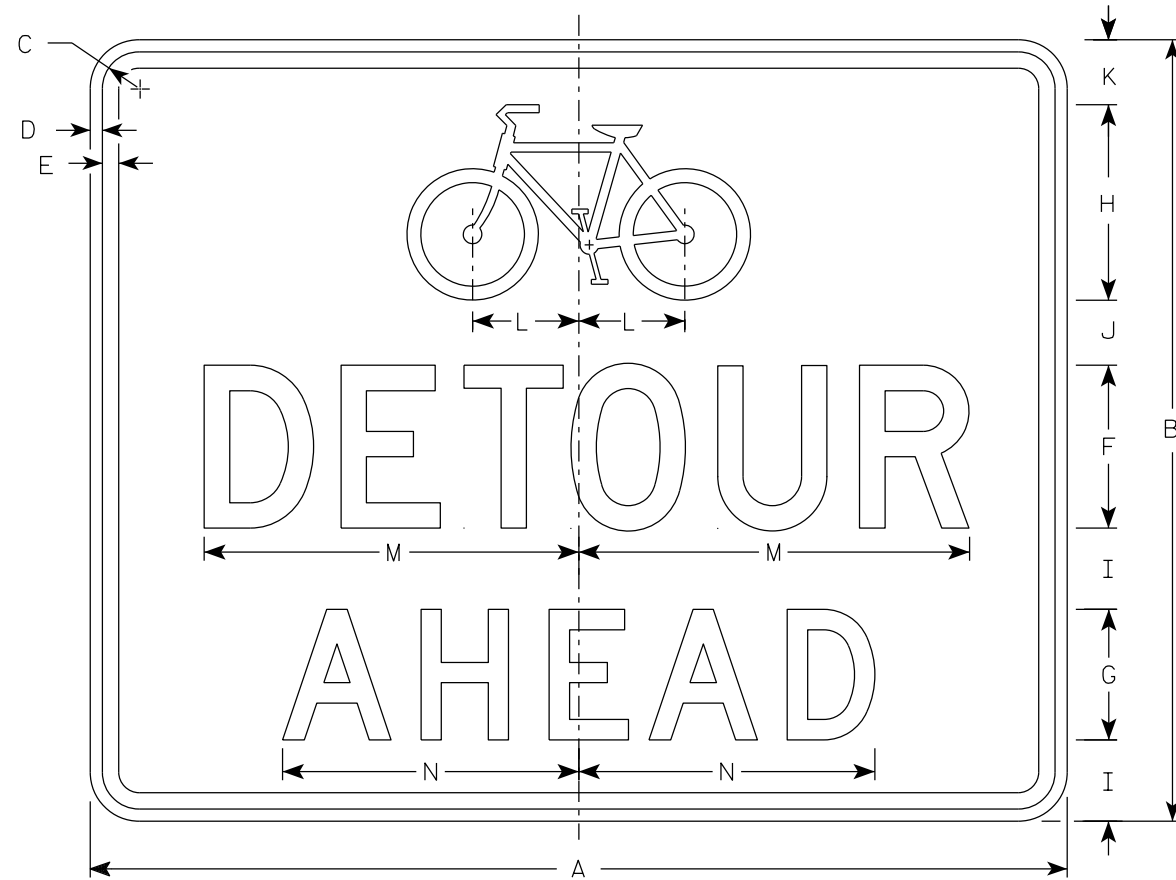

M4-9CA

SIZE	A	B	C	D	E	F	G	H	I	J	K	L	M	N	O	P	Q	R	S	T	U	V	W	X	Y	Z	Area sq. ft.
1																											
2	30	24	1 1/8	3/8	1/2	5	4	6	2 1/2	2	2	3 1/4	11 3/4	9 1/8													5.0
3																											
4																											
5																											

STANDARD SIGN
M4-9CA

WISCONSIN DEPT OF TRANSPORTATION
APPROVED *Matthew R Rauch*
For State Traffic Engineer
DATE 7/27/2020 PLATE NO. M4-9CA.1

PROJECT NO: _____ HWY: _____ COUNTY: _____ SHEET NO: **E**

NOTES

1. Sign is Type II - Type F Reflective
2. Color:
Background - Orange
Message - Black
3. Message Series - D
4. Corners may be square or rounded when base material is plywood but borders shall be rounded as shown. When base material is metal, the corners and borders shall be rounded.
5. M4-9DL is the same as M4-9DR except the arrow is reversed.

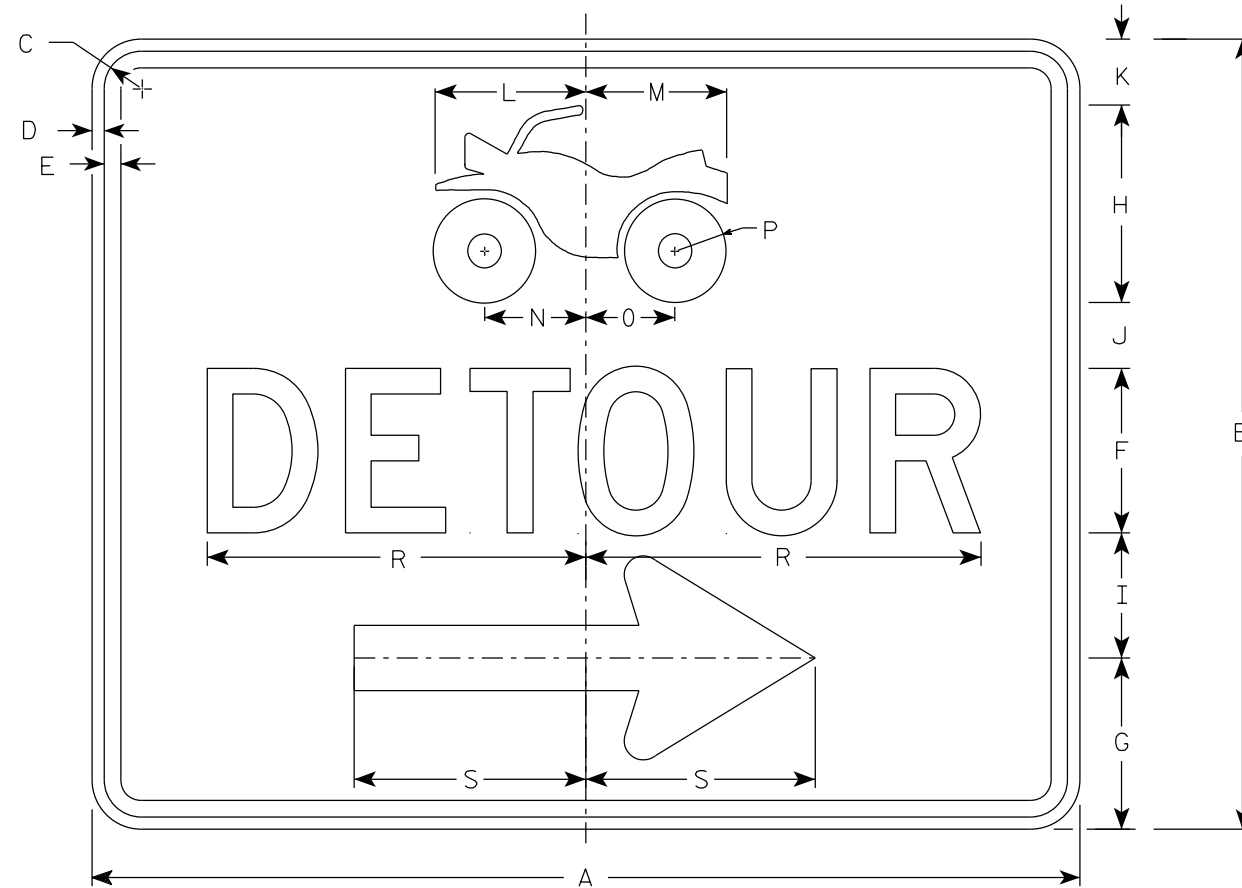

M4-9DR

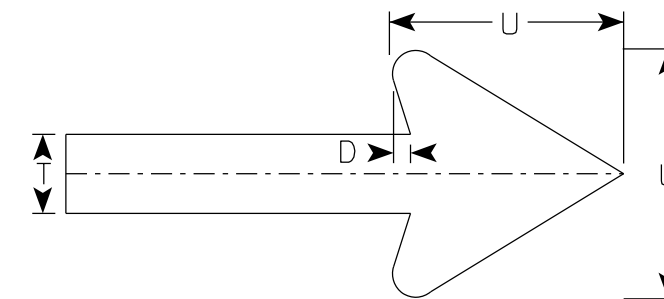

Arrow Detail

SIZE	A	B	C	D	E	F	G	H	I	J	K	L	M	N	O	P	Q	R	S	T	U	V	W	X	Y	Z	Area sq. ft.
1																											
2	30	24	1 1/8	3/8	1/2	5	5 1/4	6	3 3/4	2	2	4 5/8	4 1/4	3 1/8	2 3/4	1 1/2		11 3/4	9 1/8	2	6						5.00
3																											
4																											
5																											

STANDARD SIGN
M4-9D

WISCONSIN DEPT OF TRANSPORTATION

APPROVED *Matthew R. Rauch*
for State Traffic Engineer

DATE 7/27/2020 PLATE NO. M4-9D.1

NOTES

1. Sign is Type II - Type F Reflective
2. Color:
Background - Orange
Message - Black
3. Message Series - D
4. Corners may be square or rounded when base material is plywood but borders shall be rounded as shown. When base material is metal, the corners and borders shall be rounded.

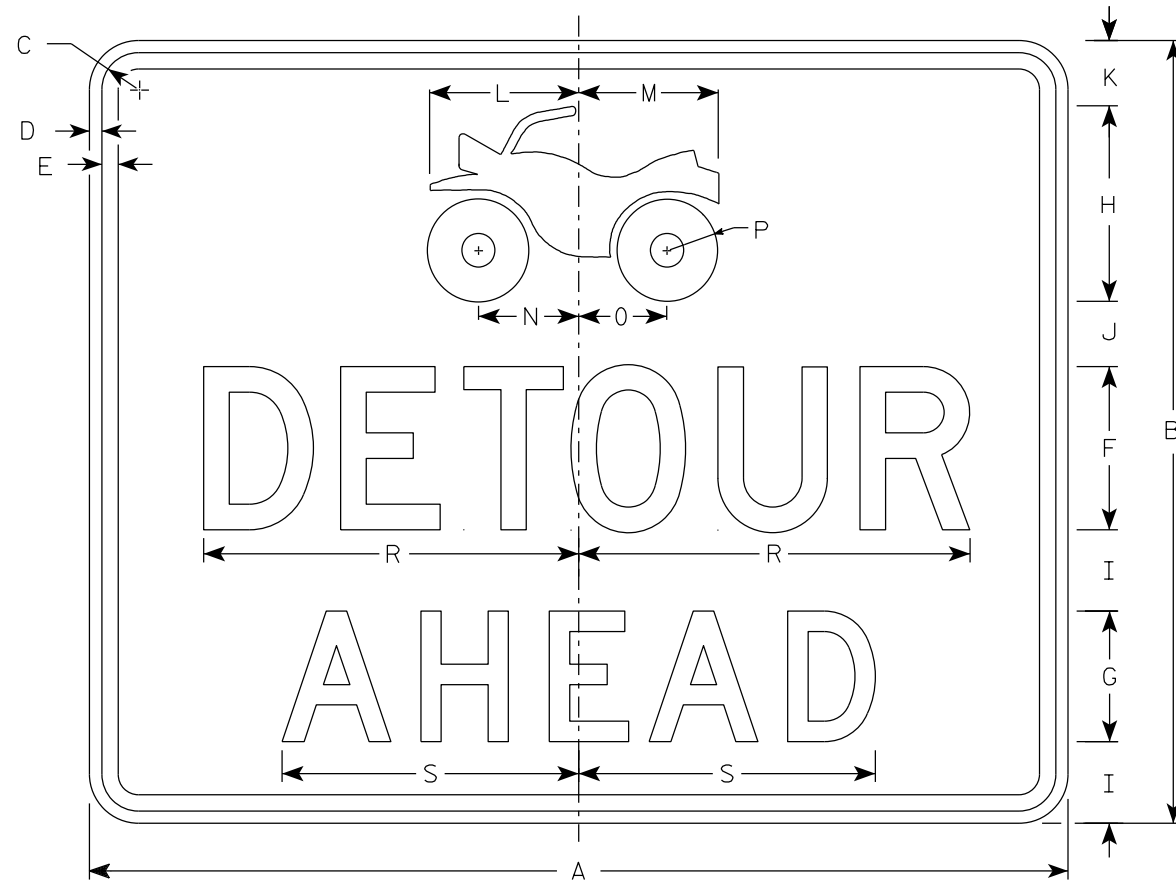

M4 - 9DA

7

7

SIZE	A	B	C	D	E	F	G	H	I	J	K	L	M	N	O	P	Q	R	S	T	U	V	W	X	Y	Z	Area sq. ft.
1																											
2	30	24	1 1/8	3/8	1/2	5	4	6	2 1/2	2	2	4 5/8	4 1/4	3 1/8	2 3/4	1 1/2		11 3/4	9 1/8								5.0
3																											
4																											
5																											

STANDARD SIGN
M4 - 9DA

WISCONSIN DEPT OF TRANSPORTATION

APPROVED *Matthew R. Rauch*
State Traffic Engineer

DATE 7/7/2020 PLATE NO. M4-9DA.1

PROJECT NO: _____ HWY: _____ COUNTY: _____ SHEET NO: _____ **E**

NOTES

1. Sign is Type II-Type F Reflective
2. Color:
Background - Orange
Message - Black
3. Message Series - D

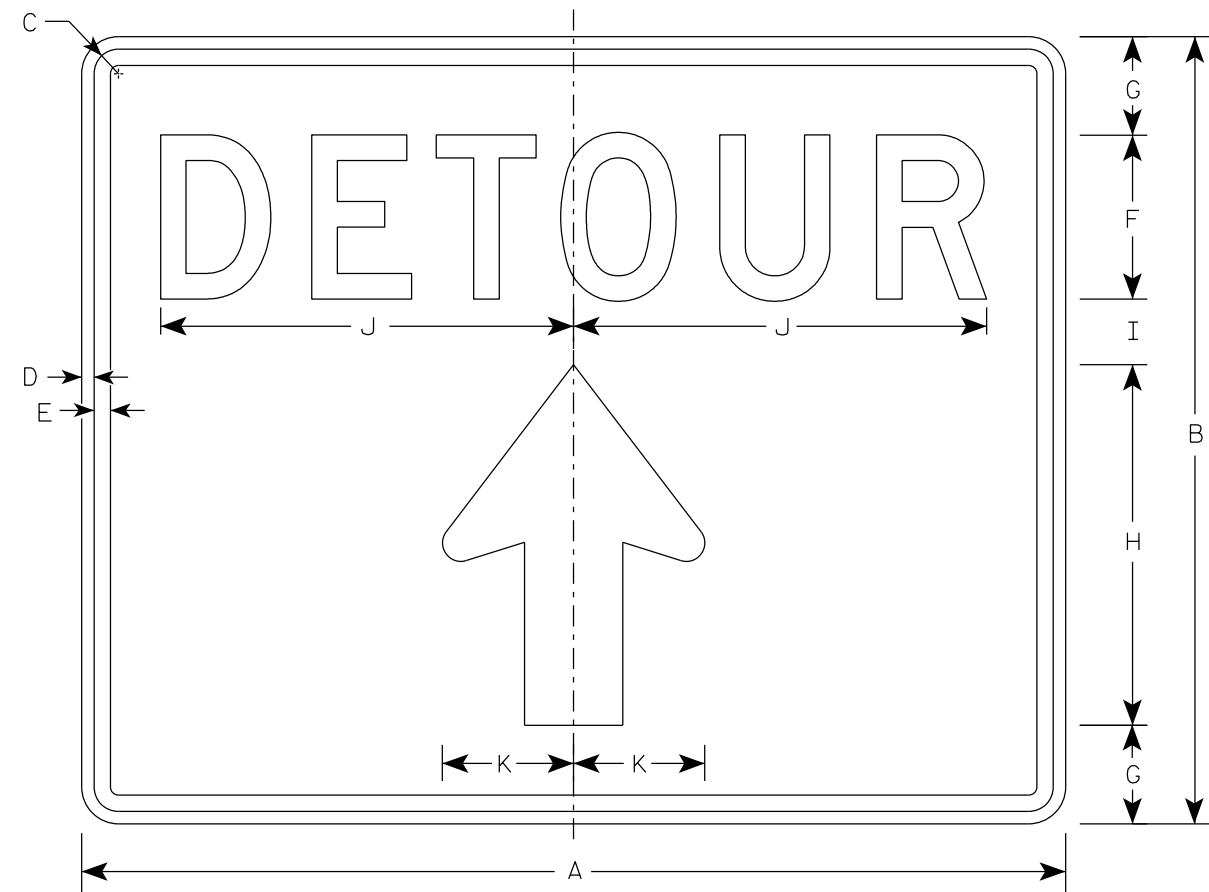

M4-9RA

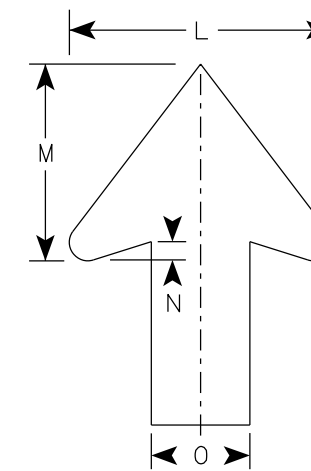

Arrow Detail

SIZE	A	B	C	D	E	F	G	H	I	J	K	L	M	N	O	P	Q	R	S	T	U	V	W	X	Y	Z	Area sq. ft.
1																											
2	30	24	1 1/8	3/8	1/2	5	3	11	2	12 5/8	4	8	6	1/2	3												5.00
3																											
4																											
5																											

STANDARD SIGN
M4-9RA

WISCONSIN DEPT OF TRANSPORTATION

APPROVED *Matthew R Rauch*
For State Traffic Engineer

DATE 12/10/2020 PLATE NO. M4-9RA.1

NOTES

1. Sign is Type II - Type H Reflective
2. Color:
Background - White
Message - Black
3. Message Series - See note 4
4. Lines 1 and 2 are Series C
Lines 3 and 4 are Series B

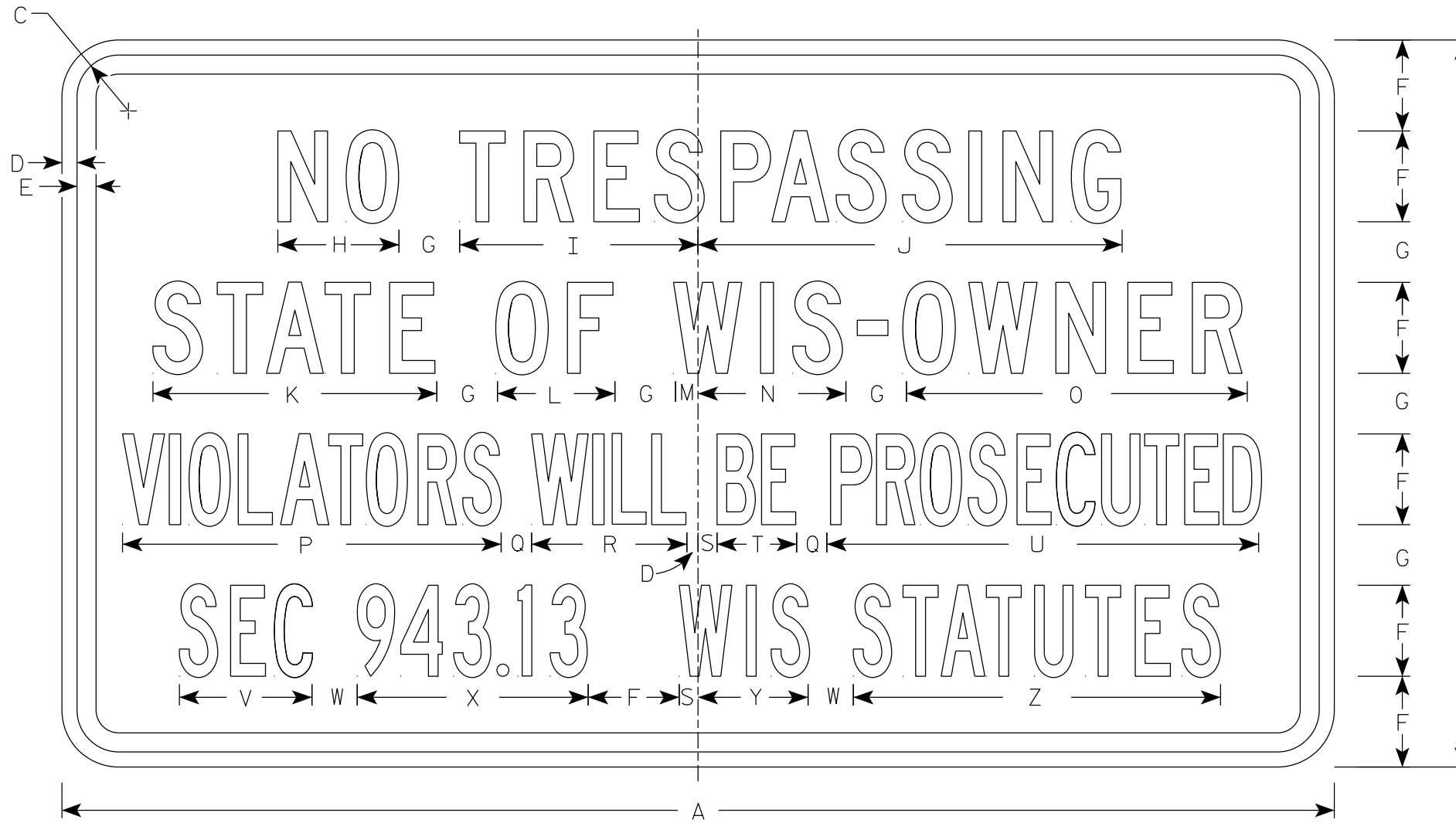

R5-98

7

7

SIZE	A	B	C	D	E	F	G	H	I	J	K	L	M	N	O	P	Q	R	S	T	U	V	W	X	Y	Z	Area sq. ft.
1																											
2S	42	24	1 3/8	1/2	5/8	3	2	4	7 7/8	14	9 3/8	3 7/8	3/4	4 7/8	11 1/4	12 1/2	1	5 1/8	5/8	2 5/8	14 1/4	4 3/8	1 1/2	7 5/8	3 5/8	12 1/8	7.00
2M	42	24	1 3/8	1/2	5/8	3	2	4	7 7/8	14	9 3/8	3 7/8	3/4	4 7/8	11 1/4	12 1/2	1	5 1/8	5/8	2 5/8	14 1/4	4 3/8	1 1/2	7 5/8	3 5/8	12 1/8	7.00
3																											
4																											
5																											

STANDARD SIGN
R5-98

WISCONSIN DEPT OF TRANSPORTATION

APPROVED *Matthew R. Rauch*
for State Traffic Engineer

DATE 7/28/2020 PLATE NO. R5-98.6

PROJECT NO: _____ HWY: _____ COUNTY: _____ SHEET NO: _____ **E**

NOTES

1. Sign is Type II - Type H Reflective
2. Color:
Background - White
Message - Black
3. Message Series - D
4. Corners may be square or rounded when base material is plywood but borders shall be rounded as shown. When base material is metal, the corners and borders shall be rounded.

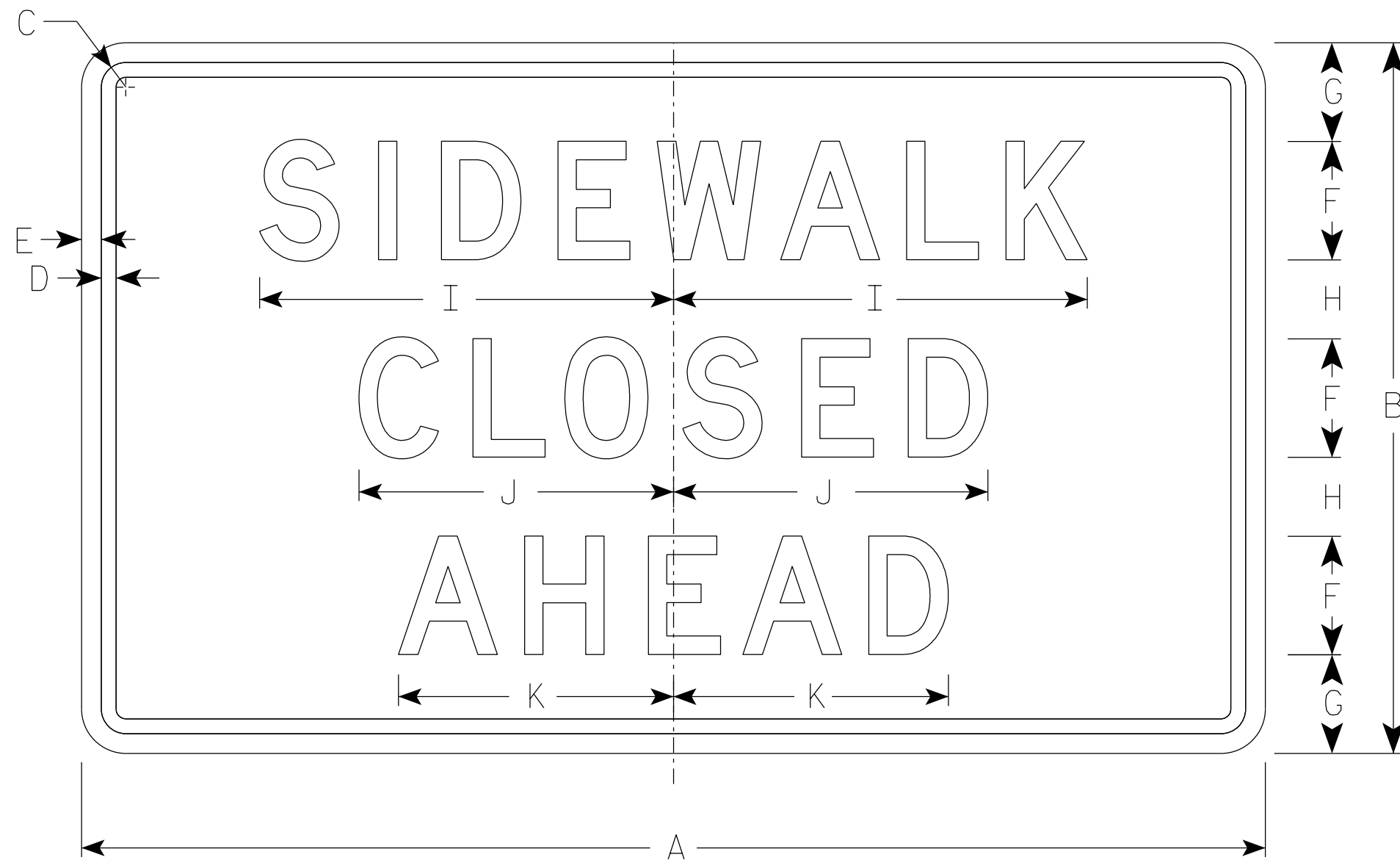

R9-9A

SIZE	A	B	C	D	E	F	G	H	I	J	K	L	M	N	O	P	Q	R	S	T	U	V	W	X	Y	Z	Area sq. ft.
1																											
2S	30	18	1 1/8	3/8	1/2	3	2 1/2	2	10 1/2	8	7																3.75
2M	30	18	1 1/8	3/8	1/2	3	2 1/2	2	10 1/2	8	7																3.75
3																											
4																											
5																											

STANDARD SIGN
R9-9A

WISCONSIN DEPT OF TRANSPORTATION

APPROVED *Matthew R. Rauch*
For State Traffic Engineer

DATE 8/31/2020 PLATE NO. R9-9A.1

PROJECT NO: _____ HWY: _____ COUNTY: _____ SHEET NO: **E**

NOTES

1. Sign is Type II - See Note 2 for Sheeting Type
2. Color:
 - Background - Top Half - Yellow (Type F Reflective)
 - Bottom Half - White (Type SH Reflective)
 - Message - Black
 - Yield Symbol - Red on White (Type SH Reflective)
 - Ped Symbol - Black on White (Type SH Reflective)
3. Message Series - C except "T0" Series D

** INSERT R1-2 AND SIZE TO FIT
 *** INSERT W11-2 AND SIZE TO FIT

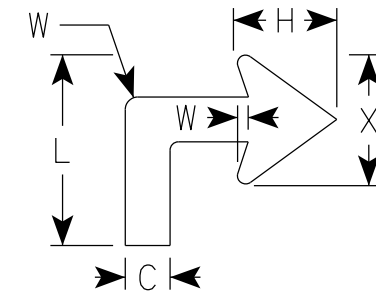

Arrow Detail

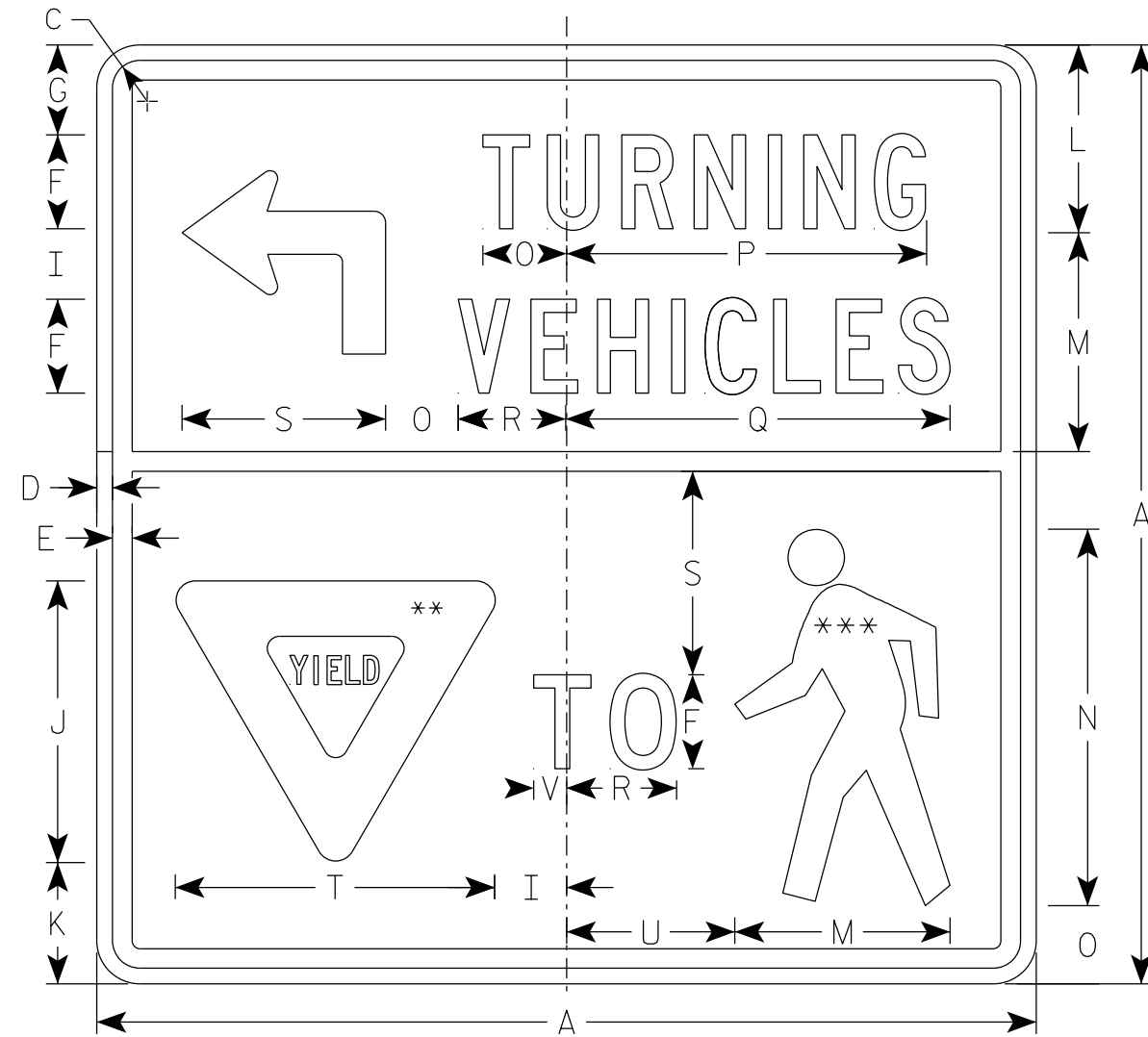

R10-15L

SIZE	A	B	C	D	E	F	G	H	I	J	K	L	M	N	O	P	Q	R	S	T	U	V	W	X	Y	Z	Area sq. ft.
1																											
2S	30		1 3/8	1/2	5/8	3	2 7/8	3	2 1/4	9	3 7/8	6	7	12	2 1/2	11 1/2	12 1/4	3 1/2	6 1/2	10 1/4	5 3/8	1	3/8	4			6.25
2M	30		1 3/8	1/2	5/8	3	2 7/8	3	2 1/4	9	3 7/8	6	7	12	2 1/2	11 1/2	12 1/4	3 1/2	6 1/2	10 1/4	5 3/8	1	3/8	4			6.25
3																											
4																											
5																											

STANDARD SIGN
 R10-15L

WISCONSIN DEPT OF TRANSPORTATION

APPROVED *Matthew R Rauch*
 for State Traffic Engineer

DATE 7/28/2020 PLATE NO. R10-15L.2

PROJECT NO: _____ HWY: _____ COUNTY: _____ SHEET NO: **E**

7

7

NOTES

- Sign is Type II - See Note 2 for Sheeting Type
- Color:
 - Background - Top Half - Yellow (Type F Reflective)
 - Background - Bottom Half - White (Type SH Reflective)
 - Message - Black
 - Yield Symbol - Red on White (Type SH Reflective)
 - Ped Symbol - Black on White (Type SH Reflective)
- Message Series - C except "T0" Series D

** INSERT R1-2 AND SIZE TO FIT
 *** INSERT W11-2 AND SIZE TO FIT

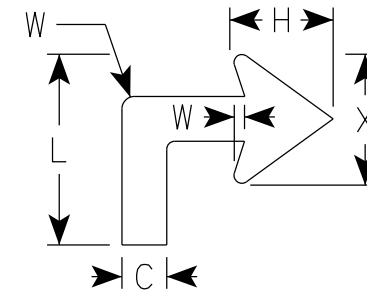

Arrow Detail

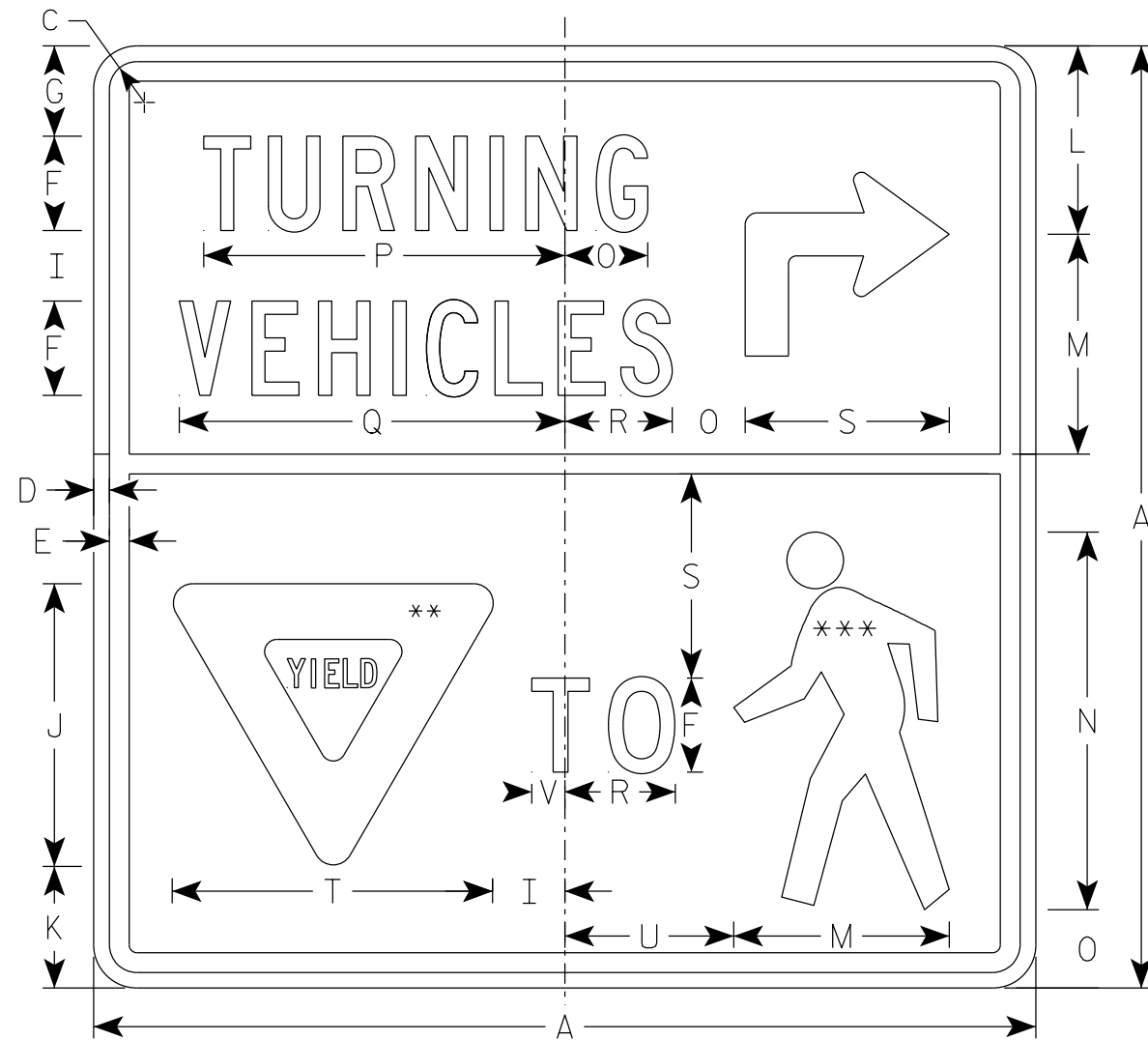

R10-15R

SIZE	A	B	C	D	E	F	G	H	I	J	K	L	M	N	O	P	Q	R	S	T	U	V	W	X	Y	Z	Area sq. ft.
1																											
2S	30		1 3/8	1/2	5/8	3	2 7/8	3	2 1/4	9	3 7/8	6	7	12	2 1/2	11 1/2	12 1/4	3 1/2	6 1/2	10 1/4	5 3/8	1	3/8	4			6.25
2M	30		1 3/8	1/2	5/8	3	2 7/8	3	2 1/4	9	3 7/8	6	7	12	2 1/2	11 1/2	12 1/4	3 1/2	6 1/2	10 1/4	5 3/8	1	3/8	4			6.25
3																											
4																											
5																											

STANDARD SIGN
 R10-15R

WISCONSIN DEPT OF TRANSPORTATION

APPROVED *Matthew R Rauch*
 For State Traffic Engineer

DATE 7/28/2020 PLATE NO. R10-15R.2

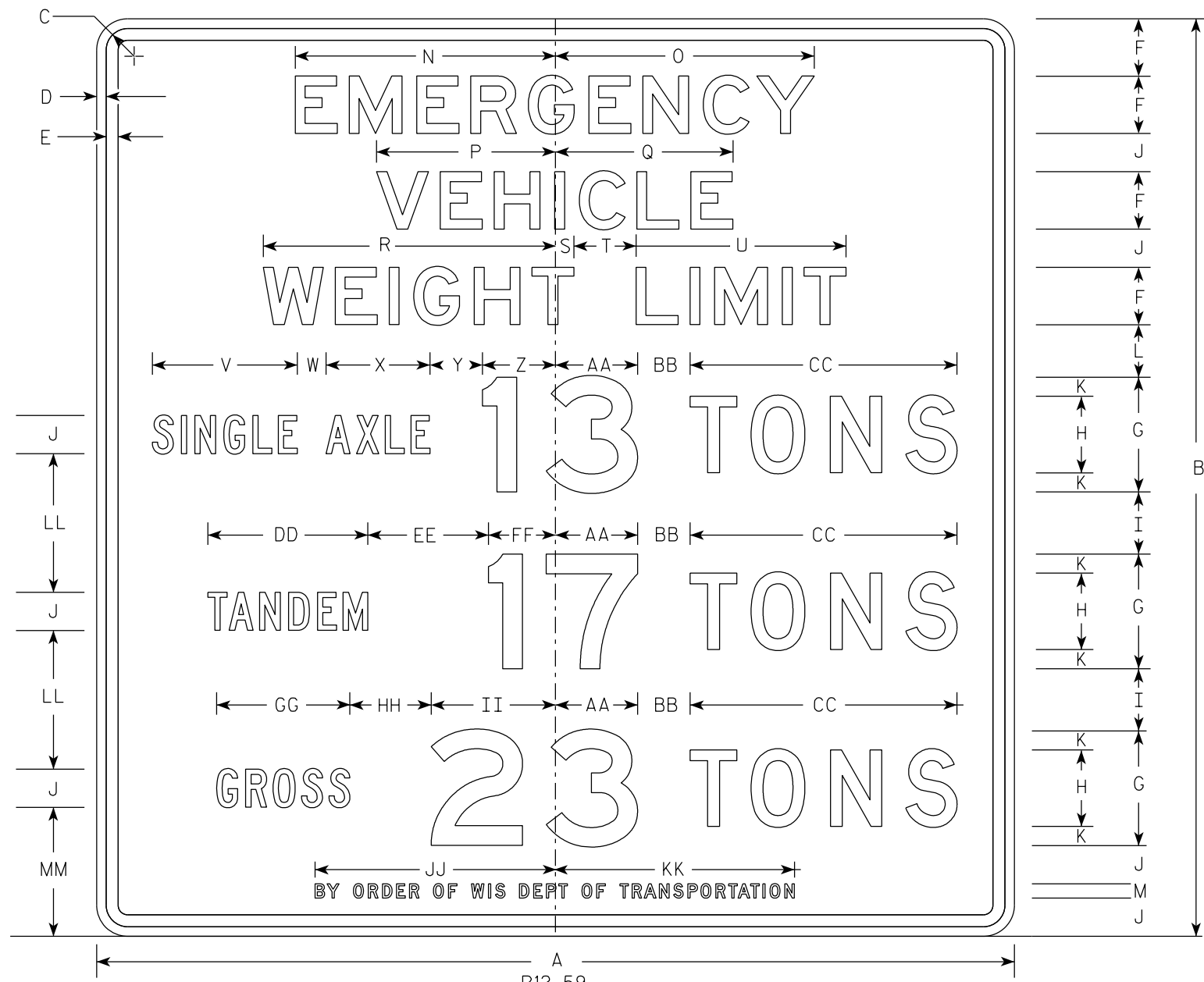

NOTES

1. Sign is Type II - Type H Reflective
2. Color:
Background - White
Message - Black
3. Message Series - See table below.
4. Substitute appropriate numerals.

7

SIZE	A	B	C	D	E	F	G	H	I	J	K	L	M	N	O	P	Q	R	S	T	U	V	W	X	Y	Z	Area sq. ft.	
1	30	30	1 1/8	3/8	1/2	2 E	4 E	2 1/2 D	1	1 1/2 C	3/4	2 1/4	3/4 D	9	9	6 1/4	6 1/4	10 1/8	3/4	2	7 3/8	5 3/4	1	4 1/8	1 1/2	1 3/8	6.25	
2S	48	48	1 5/8	1/2	5/8	3 E	6 E	4 D	3 1/4	2 C	1	2 3/4	3/4 D	13 5/8	13 1/2	9 3/8	9 1/4	15 1/4	1	3 1/4	11	7 5/8	1 1/2	5 3/8	2 3/4	3 7/8	16.0	
2M	48	48	1 5/8	1/2	5/8	3 E	6 E	4 D	3 1/4	2 C	1	2 3/4	3/4 D	13 5/8	13 1/2	9 3/8	9 1/4	15 1/4	1	3 1/4	11	7 5/8	1 1/2	5 3/8	2 3/4	3 7/8	16.0	
3																												
4																												
5																												

SIZE	AA	BB	CC	DD	EE	FF	GG	HH	II	JJ	KK	LL	MM
1	4 1/8	1	8 1/2	6 1/4	2	1 1/8	5 1/4	2 1/2	3 1/8	11 3/4	11 3/4	3 1/2	5
2S	4 1/4	2 3/4	14	8 3/8	6 1/4	3 1/2	7	4 1/4	6 1/2	12 5/8	12 1/2	7 1/4	6 3/4
2M	4 1/4	2 3/4	14	8 3/8	6 1/4	3 1/2	7	4 1/4	6 1/2	12 5/8	12 1/2	7 1/4	6 3/4
3													
4													
5													

STANDARD SIGN
R12-59

WISCONSIN DEPT OF TRANSPORTATION

APPROVED *Matthew R Raub*
for State Traffic Engineer

DATE 11/5/2020 PLATE NO. R12-59.2

PROJECT NO: _____ HWY: _____ COUNTY: _____ SHEET NO: _____ **E**

7

NOTES

1. Sign is Type II - See Note 2 for Sheeting Type
2. Color:
 - Background - See Note 4
 - Message - Black
3. Message Series - See Note 5
4. Top panel (SCHOOL) background - Yellow Green - Type F Reflective
Lower panel background - White - Type SH Reflective
5. From top to bottom:
 - Lines 1, 5, 6 & 7 are series D
 - Lines 2, 3 & 4 are series E
6. Line 4 substitute appropriate numerals and adjust spacing to achieve proper balance.

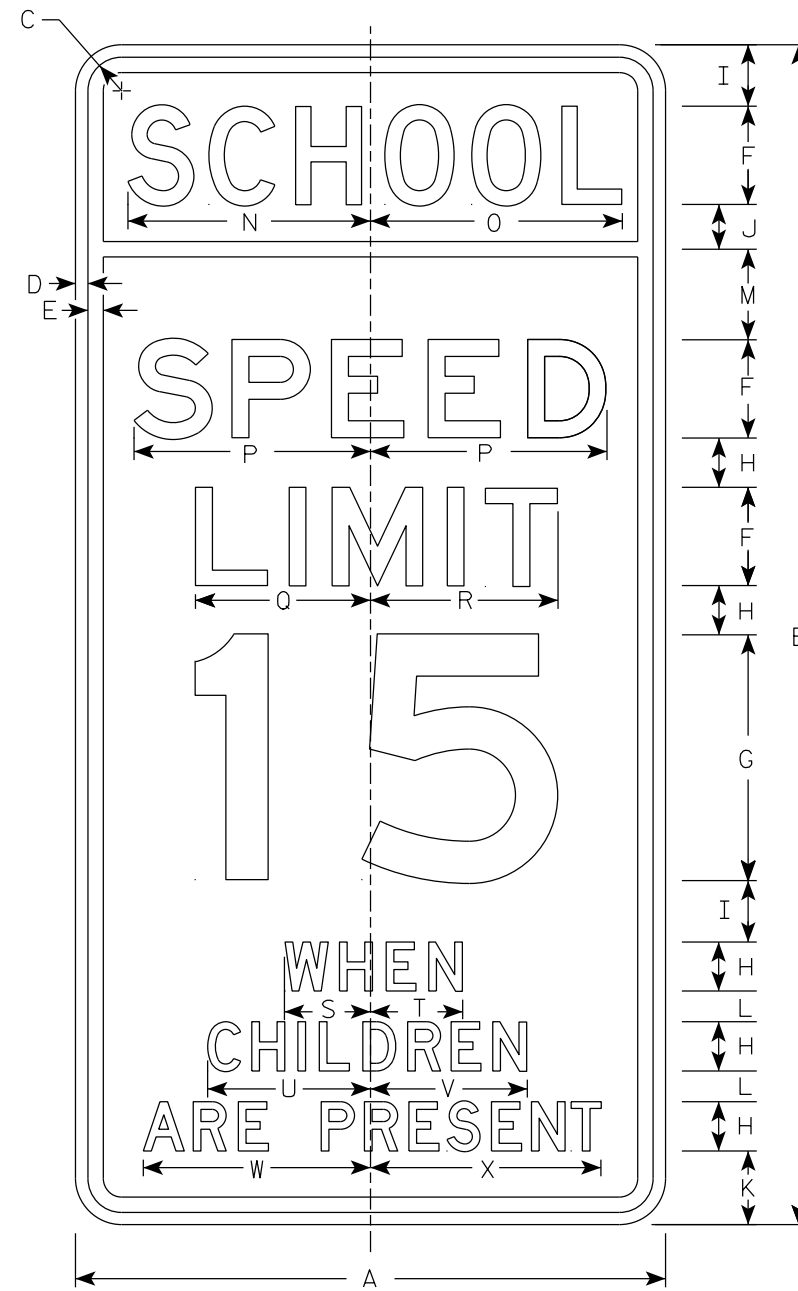

S4-51

SIZE	A	B	C	D	E	F	G	H	I	J	K	L	M	N	O	P	Q	R	S	T	U	V	W	X	Y	Z	Area sq. ft.
1																											
2	24	48	1 3/8	1/2	5/8	4	10	2	2 1/2	1 3/4	3	1 1/4	3 3/4	9 7/8	10 1/4	9 5/8	7 1/8	7 5/8	3 1/2	3 3/8	6 5/8	6 3/8	9 1/4	9 3/8		8.00	
3	36	72	2 1/4	3/4	1	6	15	3	3 3/4	2 3/4	4 1/2	1 7/8	5 1/2	15	15 1/4	14 1/2	11 1/4	11 1/2	5 1/2	5 3/4	10	9 3/4	14	14 1/8		18.00	
4																											
5																											

STANDARD SIGN
S4-51

WISCONSIN DEPT OF TRANSPORTATION

APPROVED *Matthew R. Rauch*
for State Traffic Engineer

DATE 7/27/2020 PLATE NO. S4-51.10

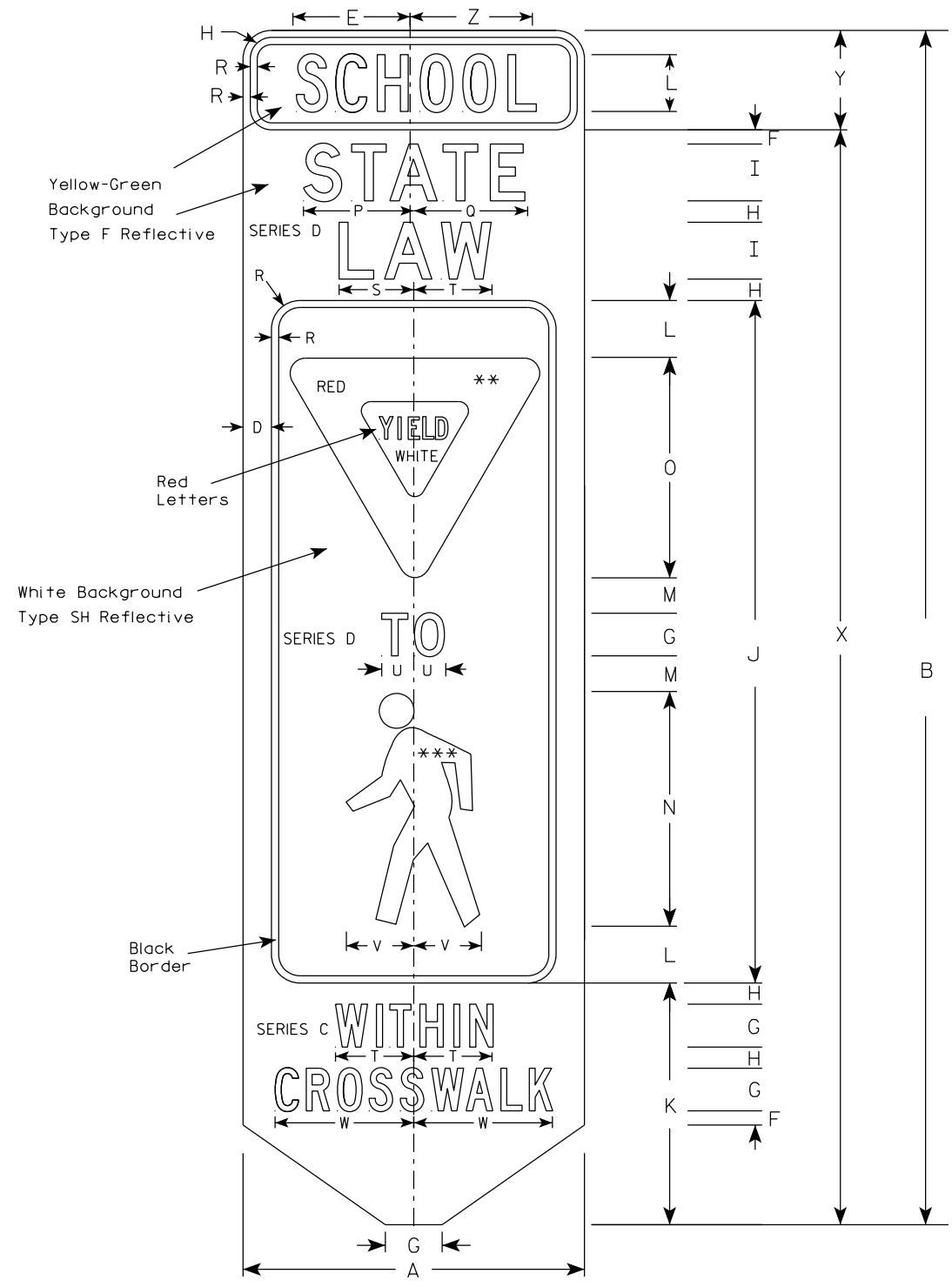

S4-52

** INSERT R1-2 AND SIZE TO FIT
 *** INSERT W11-2 AND SIZE TO FIT

NOTES

1. Sign is Type II - See Note 2 for Sheeting Type
2. Color:
 - Background - Yellow-Green (Type F Reflective)
 - Message - Black
 - Yield Symbol - Red on White (Type SH Reflective)
 - Ped Symbol - Black on White (Type SH Reflective)
3. Message Series - as shown and in table

7

7

SIZE	A	B	C	D	E	F	G	H	I	J	K	L	M	N	O	P	Q	R	S	T	U	V	W	X	Y	Z	Area sq. ft.
1																											
2	12	42	1 1/2	1	4 1/8	1/2	1 1/2 C	3/4	2 D	24	8 1/2	2	1 1/4	8 1/4	7 3/4	3 7/8	4	1/4	2 5/8	2 3/4	1 1/8	2 3/8	38 1/2	36	3 1/2	4 1/4	3.5
3																											
4																											
5																											

STANDARD SIGN
 S4-52

WISCONSIN DEPT OF TRANSPORTATION

APPROVED *Matthew R. Rauch*
 for State Traffic Engineer

DATE 7/28/2020 PLATE NO. S4-52.2

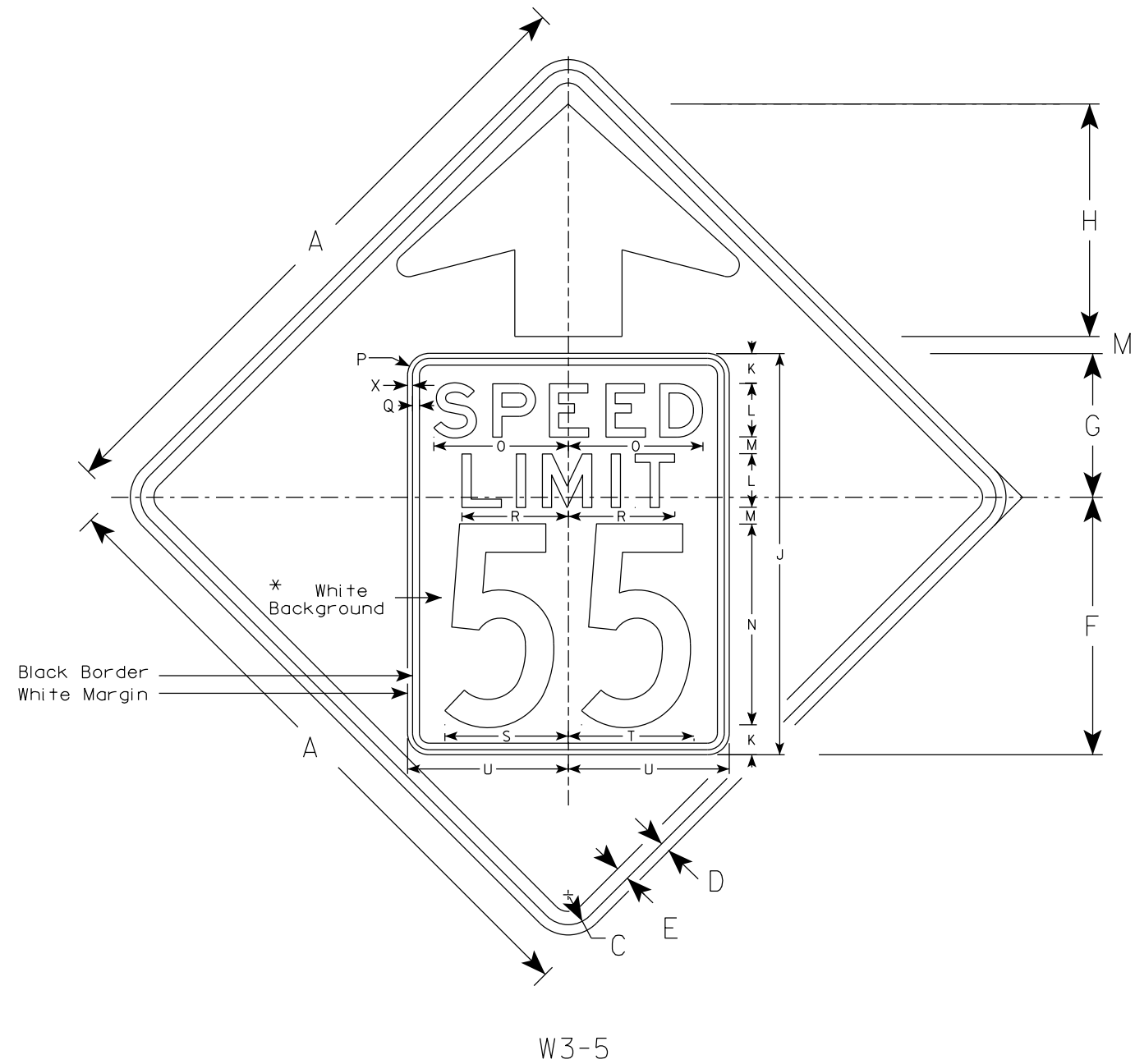

NOTES

1. Sign is Type II - See Note 2 for Sheeting Type
2. Color: *
Background - Yellow* (Type F Reflective)
Message - Black
3. Message Series - C for numbers Series E for wording
4. Substitute appropriate numerals and optically adjust spacing to achieve proper balance

*Speed Limit Sign shall have a White Background with black message (Type SH Reflective)

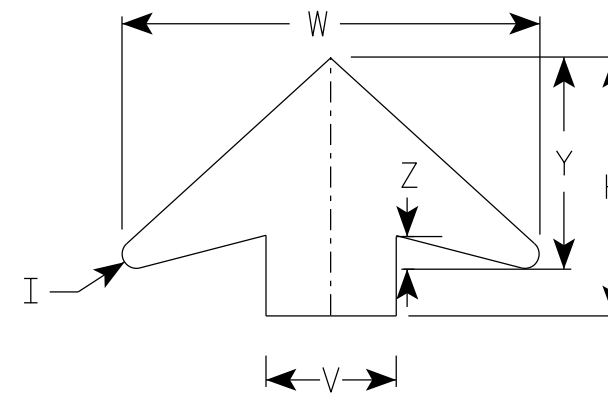

ARROW DETAIL

W3-5

SIZE	A	B	C	D	E	F	G	H	I	J	K	L	M	N	O	P	Q	R	S	T	U	V	W	X	Y	Z	Area sq. ft.
1																											
2S	36		1 5/8	5/8	3/4	14 1/2	9 1/2	11 1/2	5/8	24	2	3	1	12	7 1/8	1 1/2	3/8	5 3/4	7 1/4	7 1/8	9	6	19 1/4	3/8	9 3/4	1 5/8	9.0
2M	36		1 5/8	5/8	3/4	14 1/2	9 1/2	11 1/2	5/8	24	2	3	1	12	7 1/8	1 1/2	3/8	5 3/4	7 1/4	7 1/8	9	6	19 1/4	3/8	9 3/4	1 5/8	9.0
3	36		1 5/8	5/8	3/4	14 1/2	9 1/2	11 1/2	5/8	24	2	3	1	12	7 1/8	1 1/2	3/8	5 3/4	7 1/4	7 1/8	9	6	19 1/4	3/8	9 3/4	1 5/8	9.0
4	48		2 1/4	3/4	1	19 1/4	10 3/4	17 3/8	7/8	30	2 1/4	4	1 1/4	15	10	1 5/8	1/2	8	9 1/4	9 3/8	12	8	25 5/8	3/8	13	2	16.0
5	48		2 1/4	3/4	1	19 1/4	10 3/4	17 3/8	7/8	30	2 1/4	4	1 1/4	15	10	1 5/8	1/2	8	9 1/4	9 3/8	12	8	25 5/8	3/8	13	2	16.0

STANDARD SIGN
W3-5

WISCONSIN DEPT OF TRANSPORTATION

APPROVED *Matthew R. Rauch*
for State Traffic Engineer

DATE 7/27/2020 PLATE NO. W3-5.6

NOTES

1. Sign is Type II - Type F Reflective
2. Color:
Background - Orange
Message - Black
3. Message Series - C

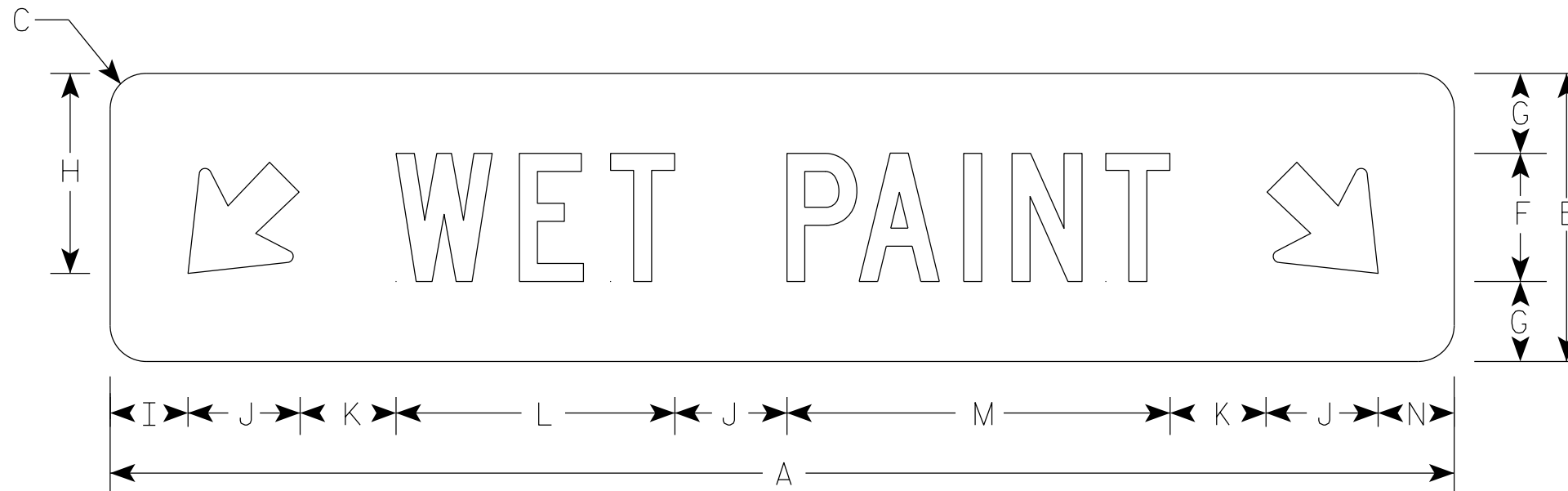

W21-64A

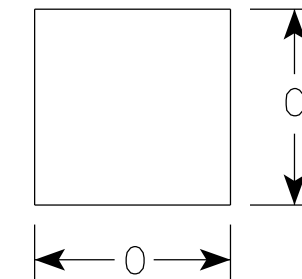

Use .040 aluminum to cover non-applicable arrow

SIZE	A	B	C	D	E	F	G	H	I	J	K	L	M	N	O	P	Q	R	S	T	U	V	W	X	Y	Z	Area sq. ft.
1																											
2	72	18	2 1/4			8	5	12 1/2	4 7/8	7	6	17 3/8	24	4 3/4	12												9.0
3																											
4																											
5																											

STANDARD SIGN
W21-64A

WISCONSIN DEPT OF TRANSPORTATION

APPROVED *Matthew R Rauch*
for State Traffic Engineer

DATE 7/27/2020 PLATE NO. W21-64A.1

PROJECT NO: _____ HWY: _____ COUNTY: _____ SHEET NO: **E**

NOTES

1. Sign is Type II - Type F Reflective
2. Color:
Background - Orange
Message - Black
3. Message Series - E

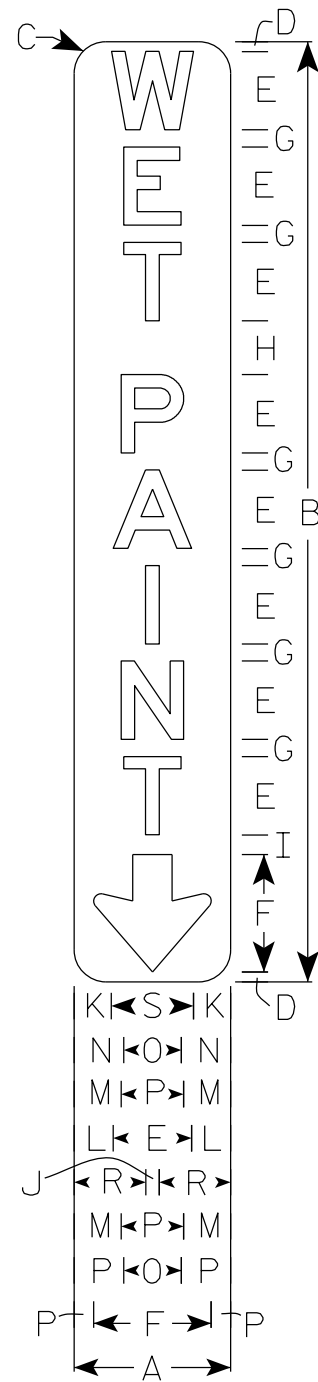

W21-64B

SIZE	A	B	C	D	E	F	G	H	I	J	K	L	M	N	O	P	Q	R	S	T	U	V	W	X	Y	Z	Area sq. ft.
1																											
2	8	48	1 5/8	1/2	4	6	7/8	2 3/4	1	3/4	1 7/8	3/4	2 3/8	2 1/2	3	3 1/4		3 5/8	4 1/4								2.67
3																											
4																											
5																											

STANDARD SIGN
W21-64B

WISCONSIN DEPT OF TRANSPORTATION

APPROVED *Matthew R. Rauch*
for
State Traffic Engineer

DATE 7/28/2020 PLATE NO. W21-64B.1

NOTES

1. Signs is Type II - Type F Reflective
2. Color:
Background - Orange
Message - Black
3. Message Series - D

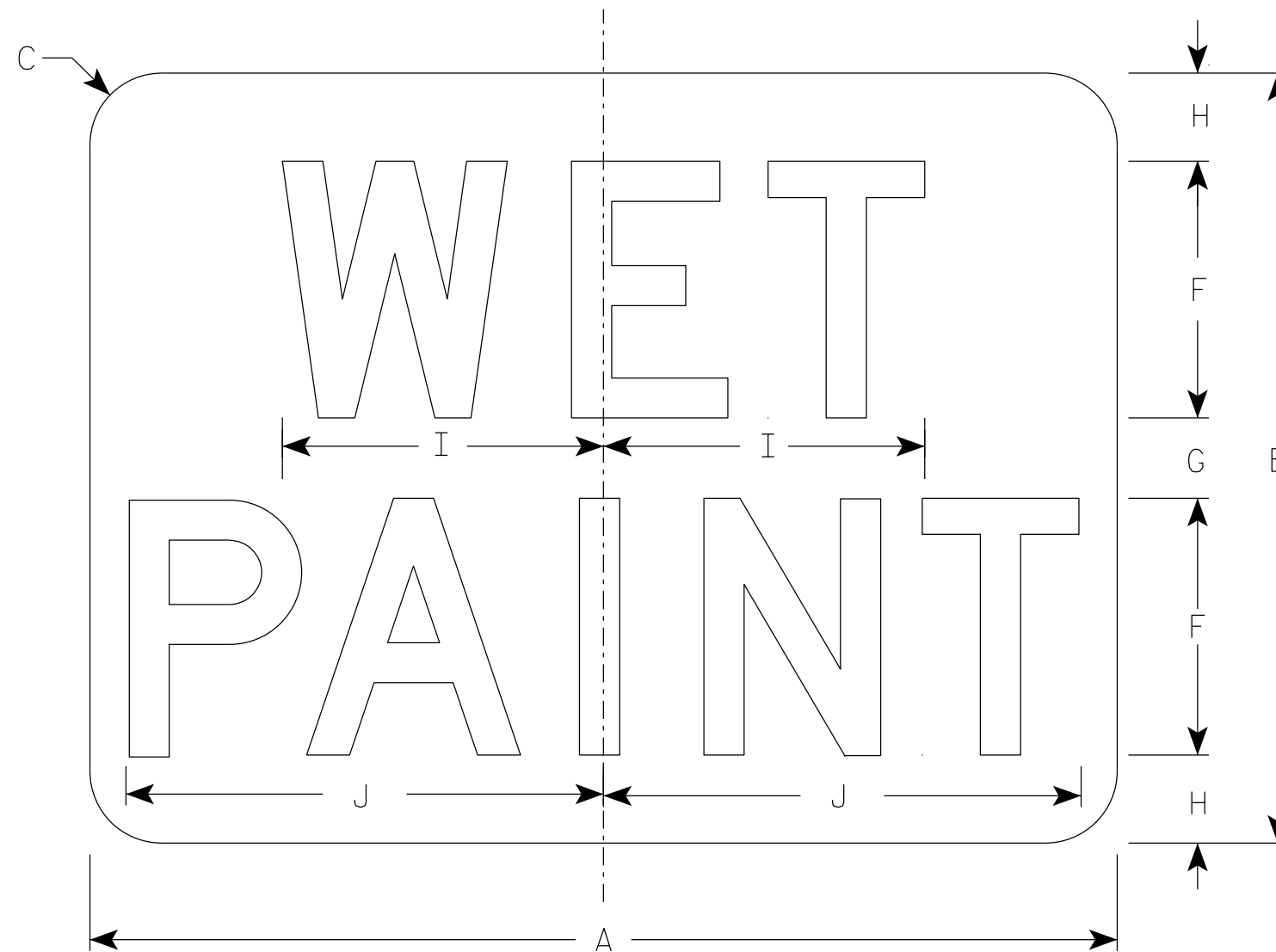

W21-64C

SIZE	A	B	C	D	E	F	G	H	I	J	K	L	M	N	O	P	Q	R	S	T	U	V	W	X	Y	Z	Area sq. ft.
1																											
2	36	24	2 1/4			8	2 1/2	2 3/4	10	14 7/8																	6.0
3																											
4																											
5																											

SPECIAL SIGN
W21-64C

WISCONSIN DEPT OF TRANSPORTATION

APPROVED *Matthew R. Raub*
for State Traffic Engineer

DATE 12/10/2020 PLATE NO. W21-64C.1

PROJECT NO: _____ HWY: _____ COUNTY: _____ SHEET NO: _____ **E**

7

7

NOTES

1. All Signs Type II - Type F Reflective except as noted
2. Color:
 - Background - Top (Orange) - Type F Reflective
 - Background - Bottom (White) - Type SH Reflective
 - Message - Black
3. Message Series - C

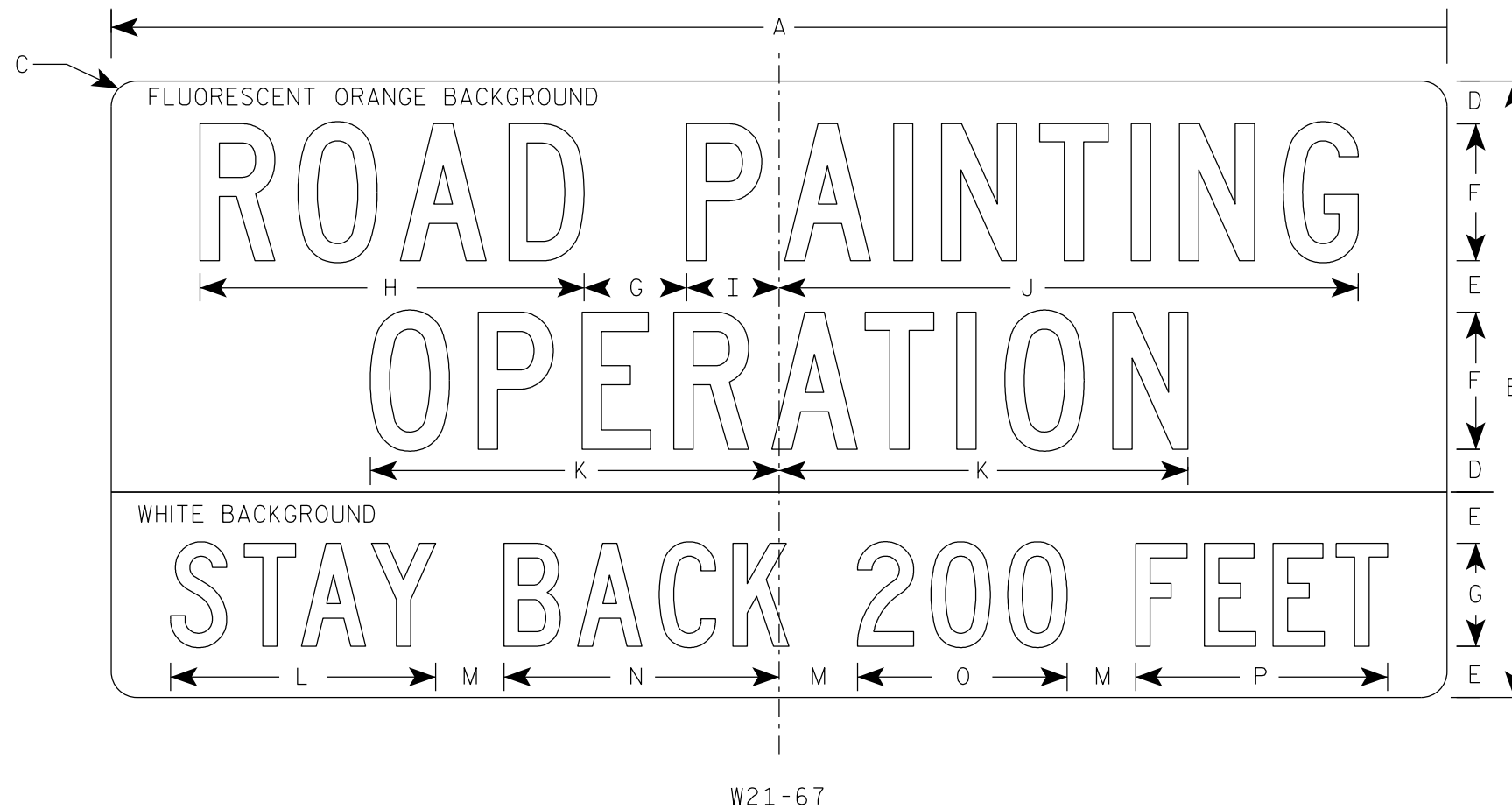

7

7

SIZE	A	B	C	D	E	F	G	H	I	J	K	L	M	N	O	P	Q	R	S	T	U	V	W	X	Area sq. ft.
1																									
2	78	36	1 1/2	2 1/2	3	8	6	22 3/8	5 3/8	33 7/8	23 7/8	15 1/2	4	16	12 1/4	14 3/4									19.5
3																									
4																									
5																									

SPECIAL SIGN
W21-67

WISCONSIN DEPT OF TRANSPORTATION

APPROVED *Matthew R. Rauch*
for State Traffic Engineer

DATE 7/27/2020 PLATE NO. W21-67.1

PROJECT NO: _____ HWY: _____ COUNTY: _____ SHEET NO: **E**

NOTES

1. Sign is Type II - Type F Reflective
2. Color:
Background - Orange
Message - Black
3. Message Series - C

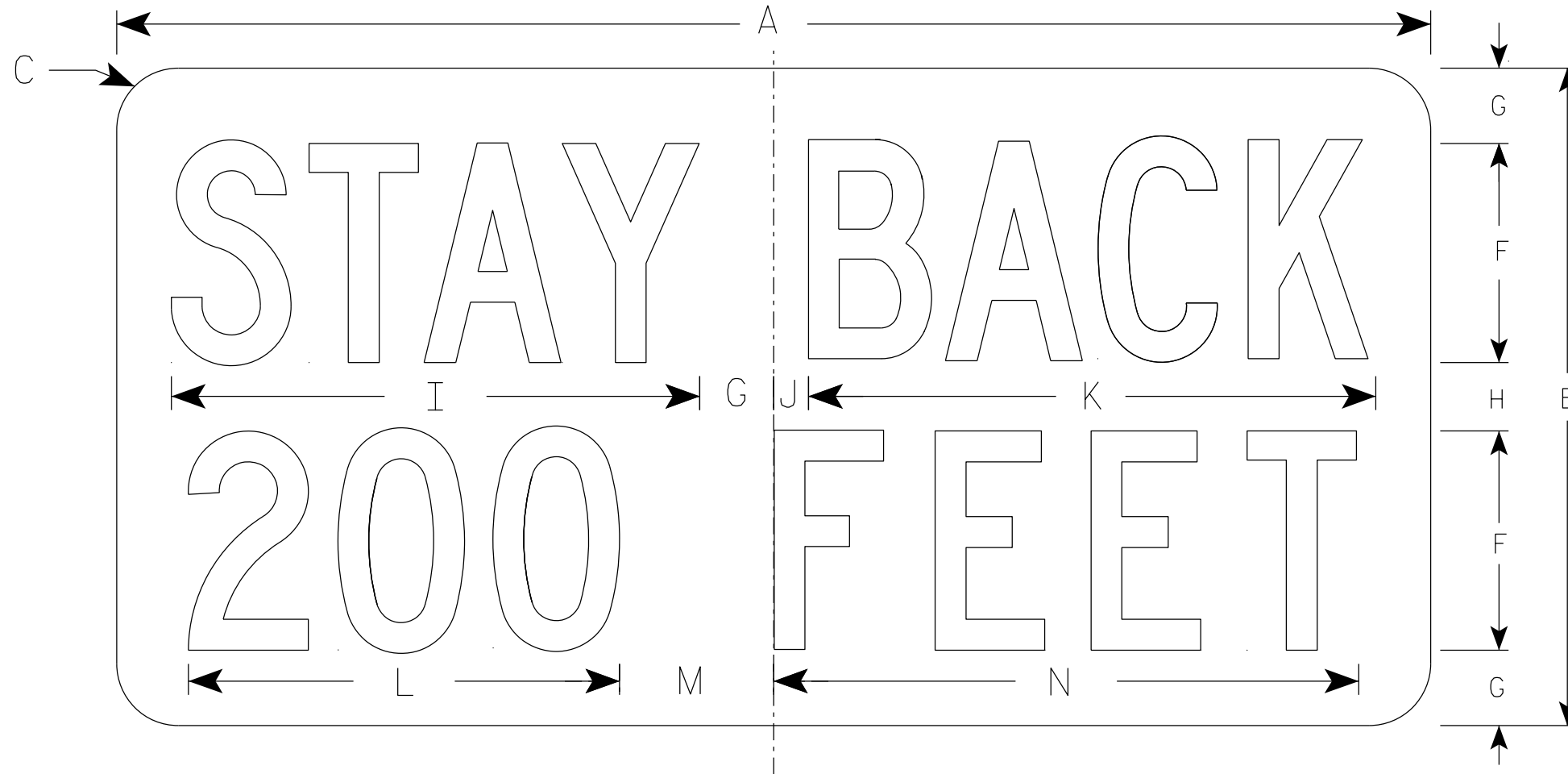

W21-68

7

7

SIZE	A	B	C	D	E	F	G	H	I	J	K	L	M	N	O	P	Q	R	S	T	U	V	W	X	Y	Z	Area sq. ft.
1																											
2	48	24	2 1/4			8	2 3/4	2 1/2	19 1/4	1 1/4	20 3/4	15 3/4	5 5/8	21 3/8													8.0
3																											
4																											
5																											

STANDARD SIGN
W21-68

WISCONSIN DEPT OF TRANSPORTATION

APPROVED *Matthew R. Rauch*
for State Traffic Engineer

DATE 7/27/2020 PLATE NO. W21-68.1

PROJECT NO: _____ HWY: _____ COUNTY: _____ SHEET NO: **E**