

# HIGHWAY WORK PROPOSAL

Wisconsin Department of Transportation  
 DT1502 01/2020 s.66.0901(7) Wis. Stats

Proposal Number: **021**

<u>COUNTY</u>	<u>STATE PROJECT</u>	<u>FEDERAL</u>	<u>PROJECT DESCRIPTION</u>	<u>HIGHWAY</u>
Dodge	6995-00-13	WISC 2022081	C Beaver Dam, East Davis Street; S Spring Street To S University Ave	LOC STR
Dodge	6995-00-14	N/A	C Beaver Dam, East Davis Street; S Spring Street To S University Ave	LOC STR

## ADDENDUM REQUIRED ATTACHED AT BACK

This proposal, submitted by the undersigned bidder to the Wisconsin Department of Transportation, is in accordance with the advertised request for proposals. The bidder is to furnish and deliver all materials, and to perform all work for the improvement of the designated project in the time specified, in accordance with the appended Proposal Requirements and Conditions.

Proposal Guaranty Required: \$75,000.00 Payable to: Wisconsin Department of Transportation	Attach Proposal Guaranty on back of this PAGE.
Bid Submittal Date: December 14, 2021 Time (Local Time): 11:00 am	Firm Name, Address, City, State, Zip Code  <h3 style="margin: 0;">SAMPLE</h3> <h3 style="margin: 0;">NOT FOR BIDDING PURPOSES</h3>
Contract Completion Time October 01, 2022	This contract is exempt from federal oversight.
Assigned Disadvantaged Business Enterprise Goal <b>10%</b>	

This certifies that the undersigned bidder, duly sworn, is an authorized representative of the firm named above; that the bidder has examined and carefully prepared the bid from the plans, Highway Work Proposal, and all addenda, and has checked the same in detail before submitting this proposal or bid; and that the bidder or agents, officer, or employees have not, either directly or indirectly, entered into any agreement, participated in any collusion, or otherwise taken any action in restraint of free competitive bidding in connection with this proposal bid.

Do not sign, notarize, or submit this Highway Work Proposal when submitting an electronic bid on the Internet.

Subscribed and sworn to before me this date \_\_\_\_\_

\_\_\_\_\_  
 (Signature, Notary Public, State of Wisconsin)

\_\_\_\_\_  
 (Bidder Signature)

\_\_\_\_\_  
 (Print or Type Name, Notary Public, State Wisconsin)

\_\_\_\_\_  
 (Print or Type Bidder Name)

\_\_\_\_\_  
 (Date Commission Expires)

\_\_\_\_\_  
 (Bidder Title)

Notary Seal

Type of Work: Grade, Sanitary Sewer, Water Main, Storm Sewer, Base, Concrete Pavement, Asphalt Pavement, Curb & Gutter, Sidewalk, Lighting, Signing, Pavement Marking	<b>For Department Use Only</b>
Notice of Award Dated	Date Guaranty Returned

**PLEASE ATTACH  
PROPOSAL GUARANTY HERE**

**Effective with November 2007 Letting**

**PROPOSAL REQUIREMENTS AND CONDITIONS**

The bidder, signing and submitting this proposal, agrees and declares as a condition thereof, to be bound by the following conditions and requirements.

If the bidder has a corporate relationship with the proposal design engineering company, the bidder declares that it did not obtain any facts, data, or other information related to this proposal from the design engineering company that was not available to all bidders.

The bidder declares that they have carefully examined the site of, and the proposal, plans, specifications and contract forms for the work contemplated, and it is assumed that the bidder has investigated and is satisfied as to the conditions to be encountered, as to the character, quality, and quantities of work to be performed and materials to be furnished, and as to the requirements of the specifications, special provisions and contract. It is mutually agreed that submission of a proposal shall be considered conclusive evidence that the bidder has made such examination.

The bidder submits herewith a proposal guaranty in proper form and amount payable to the party as designated in the advertisement inviting proposals, to be retained by and become the property of the owner of the work in the event the undersigned shall fail to execute the contract and contract bond and return the same to the office of the engineer within fourteen (14) days after having been notified in writing to do so; otherwise to be returned.

The bidder declares that they understand that the estimate of quantities in the attached schedule is approximate only and that the attached quantities may be greater or less in accordance with the specifications.

The bidder agrees to perform the said work, for and in consideration of the payment of the amount becoming due on account of work performed, according to the unit prices bid in the following schedule, and to accept such amounts in full payment of said work.

The bidder declares that all of the said work will be performed at their own proper cost and expense, that they will furnish all necessary materials, labor, tools, machinery, apparatus, and other means of construction in the manner provided in the applicable specifications and the approved plans for the work together with all standard and special designs that may be designed on such plans, and the special provisions in the contract of which this proposal will become a part, if and when accepted. The bidder further agrees that the applicable specifications and all plans and working drawings are made a part hereof, as fully and completely as if attached hereto.

The bidder, if awarded the contract, agrees to begin the work not later than ten (10) days after the date of written notification from the engineer to do so, unless otherwise stipulated in the special provisions.

The bidder declares that if they are awarded the contract, they will execute the contract agreement and begin and complete the work within the time named herein, and they will file a good and sufficient surety bond for the amount of the contract for performance and also for the full amount of the contract for payment.

The bidder, if awarded the contract, shall pay all claims as required by Section 779.14, Statutes of Wisconsin, and shall be subject to and discharge all liabilities for injuries pursuant to Chapter 102 of the Statutes of Wisconsin, and all acts amendatory thereto. They shall further be responsible for any damages to property or injury to persons occurring through their own negligence or that of their employees or agents, incident to the performance of work under this contract, pursuant to the Standard Specifications for Road and Bridge Construction applicable to this contract.

In connection with the performance of work under this contract, the contractor agrees to comply with all applicable state and federal statutes relating to non-discrimination in employment. No otherwise qualified person shall be excluded from employment or otherwise be subject to discrimination in employment in any manner on the basis of age, race, religion, color, gender, national origin or ancestry, disability, arrest or conviction record (in keeping with s.111.32), sexual orientation, marital status, membership in the military reserve, honesty testing, genetic testing, and outside use of lawful products. This provision shall include, but not be limited to the following: employment, upgrading, demotion or transfer; recruitment or recruitment advertising; layoff or termination; rates of pay or other forms of compensation, and selection for training, including apprenticeship. The contractor further agrees to ensure equal opportunity in employment to all applicants and employees and to take affirmative action to attain a representative workforce.

The contractor agrees to post notices and posters setting forth the provisions of the nondiscrimination clause, in a conspicuous and easily accessible place, available for employees and applicants for employment.

If a state public official (section 19.42, Stats.) or an organization in which a state public official holds at least a 10% interest is a party to this agreement, this contract is voidable by the state unless appropriate disclosure is made to the State of Wisconsin Ethics Board.

## Effective with August 2015 Letting

### BID PREPARATION

#### Preparing the Proposal Schedule of Items

##### A General

- (1) Obtain bidding proposals as specified in section 102 of the standard specifications prior to 11:45 AM of the last business day preceding the letting. Submit bidding proposals using one of the following methods:
  1. Electronic bid on the internet.
  2. Electronic bid on a printout with accompanying diskette or CD ROM.
  3. Paper bid under a waiver of the electronic submittal requirements.

- (2) Bids submitted on a printout with accompanying diskette or CD ROM or paper bids submitted under a waiver of the electronic submittal requirements govern over bids submitted on the internet.

- (3) The department will provide bidding information through the department's web site at:  
<https://wisconsindot.gov/Pages/doing-bus/contractors/hcci/bid-let.aspx>

The contractor is responsible for reviewing this web site for general notices as well as information regarding proposals in each letting. The department will also post special notices of all addenda to each proposal through this web site no later than 4:00 PM local time on the Thursday before the letting. Check the department's web site after 5:00 PM local time on the Thursday before the letting to ensure all addenda have been accounted for before preparing the bid. When bidding using methods 1 and 2 above, check the Bid Express™ on-line bidding exchange at <http://www.bidx.com/> after 5:00 PM local time on the Thursday before the letting to ensure that the latest schedule of items Expedite file (\*.ebs or \*.00x) is used to submit the final bid.

- (4) Interested parties can subscribe to the Bid Express™ on-line bidding exchange by following the instructions provided at the [www.bidx.com](http://www.bidx.com) web site or by contacting:

Info Tech Inc.  
5700 SW 34th Street, Suite 1235  
Gainesville, FL 32608-5371  
email: <mailto:customer.support@bidx.com>

- (5) The department will address equipment and process failures, if the bidder can demonstrate that those failures were beyond their control.
- (6) Contractors are responsible for checking on the issuance of addenda and for obtaining the addenda. Notice of issuance of addenda is posted on the department's web site at:  
<https://wisconsindot.gov/Pages/doing-bus/contractors/hcci/bid-let.aspx>

or by calling the department at (608) 266-1631. Addenda can ONLY be obtained from the departments web site listed above or by picking up the addenda at the Bureau of Highway Construction, 4<sup>th</sup> floor, 4822 Madison Yards Way, Madison, WI, during regular business hours.

- (7) Addenda posted after 5:00 PM on the Thursday before the letting will be emailed to the eligible bidders for that proposal. All eligible bidders shall acknowledge receipt of the addenda whether they are bidding on the proposal or not. Not acknowledging receipt may jeopardize the awarding of the project.

##### B Submitting Electronic Bids

###### B.1 On the Internet

- (1) Do the following before submitting the bid:
  1. Have a properly executed annual bid bond on file with the department.

2. Have a digital ID on file with and enabled by Info Tech Inc. Using this digital ID will constitute the bidder's signature for proper execution of the bidding proposal.
- (2) In lieu of preparing, delivering, and submitting the proposal as specified in 102.6 and 102.9 of the standard specifications, submit the proposal on the internet as follows:
  1. Download the latest schedule of items reflecting all addenda from the Bid Express™ web site.
  2. Use Expedite™ software to enter a unit price for every item in the schedule of items.
  3. Submit the bid according to the requirements of Expedite™ software and the Bid Express™ web site. Do not submit a bid on a printout with accompanying diskette or CD ROM or a paper bid. If the bidder does submit a bid on a printout with accompanying diskette or a paper bid in addition to the internet submittal, the department will disregard the internet bid.
  4. Submit the bid before the hour and date the Notice to Contractors designates.
  5. Do not sign, notarize, and return the bidding proposal described in 102.2 of the standard specifications.
- (3) The department will not consider the bid accepted until the hour and date the Notice to Contractors designates.

## **B.2 On a Printout with Accompanying Diskette or CD ROM**

- (1) Download the latest schedule of items from the Wisconsin pages of the Bid Express™ web site reflecting the latest addenda posted on the department's web site at:  
<https://wisconsindot.gov/Pages/doing-bus/contractors/hcci/bid-let.aspx>  
Use Expedite™ software to prepare and print the schedule of items. Provide a valid amount for all price fields. Follow instructions and review the help screens provided on the Bid Express™ web site to assure that the schedule of items is prepared properly.
- (2) Staple an 8 1/2 by 11 inch printout of the Expedite™ generated schedule of items to the other proposal documents submitted to the department as a part of the bidder's sealed bid. As a separate submittal, not in the sealed bid envelop but due at the same time and place as the sealed bid, also provide the Expedite™ generated schedule of items on a 3 1/2 inch computer diskette or CD ROM. Label each diskette or CD ROM with the bidder's name, the 4 character department-assigned bidder identification code from the top of the bidding proposal, and a list of the proposal numbers included on that diskette or CD ROM as indicated in the following example:

**Bidder Name**

**BN00**

**Proposals: 1, 12, 14, & 22**

- (3) If bidding on more than one proposal in the letting, the bidder may include all proposals for that letting on one diskette or CD ROM. Include only submitted proposals with no incomplete or other files on the diskette or CD ROM.
- (4) The bidder-submitted printout of the Expedite™ generated schedule of items is the governing contract document and must conform to the requirements of section 102 of the standard specifications. If a printout needs to be altered, cross out the printed information with ink or typewriter and enter the new information and initial it in ink. If there is a discrepancy between the printout and the diskette or CD ROM, the department will analyze the bid using the printout information.
- (5) In addition to the reasons specified in section 102 of the standard specifications, proposals are irregular and the department may reject them for one or more of the following:
  1. The check code printed on the bottom of the printout of the Expedite™ generated schedule of items is not the same on each page.
  2. The check code printed on the printout of the Expedite™ generated schedule of items is not the same as the check code for that proposal provided on the diskette or CD ROM.

3. The diskette or CD ROM is not submitted at the time and place the department designates.

### **C Waiver of Electronic Submittal**

- (1) The bidder may request a waiver of the electronic submittal requirements. Submit a written request for a waiver in lieu of bids submitted on the internet or on a printout with accompanying diskette or CD ROM. Use the waiver that was included with the paper bid document sent to the bidder or type up a waiver on the bidder's letterhead. The department will waive the electronic submittal requirements for a bidding entity (individual, partnership, joint venture, corporation, or limited liability company) for up to 4 individual proposals in a calendar year. The department may allow additional waivers for equipment malfunctions.
- (2) Submit a schedule of items on paper conforming to section 102 of the standard specifications. The department charges the bidder a \$75 administrative fee per proposal, payable at the time and place the department designates for receiving bids, to cover the costs of data entry. The department will accept a check or money order payable to: "Wisconsin, Dept. of Transportation."
- (3) In addition to the reasons specified in section 102 of the standard specifications, proposals are irregular and the department may reject them for one or more of the following:
  1. The bidder fails to provide the written request for waiver of the electronic submittal requirements.
  2. The bidder fails to pay the \$75 administrative fee before the time the department designates for the opening of bids unless the bidder requests on the waiver that they be billed for the \$75.
  3. The bidder exceeds 4 waivers of electronic submittal requirements within a calendar year.
- (4) In addition to the reasons specified in section 102 of the standard specifications, the department may refuse to issue bidding proposals for future contracts to a bidding entity that owes the department administrative fees for a waiver of electronic submittal requirements.

**PROPOSAL BID BOND**

DT1303 1/2006

Wisconsin Department of Transportation

Proposal Number	Project Number	Letting Date
Name of Principal		
Name of Surety	State in Which Surety is Organized	

We, the above-named Principal and the above-named Surety, are held and firmly bound unto the State of Wisconsin in the sum equal to the Proposal Guaranty for the total bid submitted for the payment to be made; we jointly and severally bind ourselves, our heirs, executors, administrators, successors and assigns. The condition of this obligation is that the Principal has submitted a bid proposal to the State of Wisconsin acting through the Department of Transportation for the improvement designated by the Proposal Number and Letting Date indicated above.

If the Principal is awarded the contract and, within the time and manner required by law after the prescribed forms are presented for signature, enters into a written contract in accordance with the bid, and files the bond with the Department of Transportation to guarantee faithful performance and payment for labor and materials, as required by law, or if the Department of Transportation shall reject all bids for the work described, then this obligation shall be null and void; otherwise, it shall be and remain in full force and effect. In the event of failure of the Principal to enter into the contract or give the specified bond, the Principal shall pay to the Department of Transportation **within 10 business days of demand** a total equal to the Proposal Guaranty as liquidated damages; the liability of the Surety continues for the full amount of the obligation as stated until the obligation is paid in full.

The Surety, for value received, agrees that the obligations of it and its bond shall not be impaired or affected by any extension of time within which the Department of Transportation may accept the bid; and the Surety does waive notice of any such extension.

IN WITNESS, the Principal and Surety have agreed and have signed by their proper officers and have caused their corporate seals to be affixed this date: **(DATE MUST BE ENTERED)**

**PRINCIPAL**

\_\_\_\_\_  
(Company Name) **(Affix Corporate Seal)**

\_\_\_\_\_  
(Signature and Title)

\_\_\_\_\_  
(Company Name)

\_\_\_\_\_  
(Signature and Title)

\_\_\_\_\_  
(Company Name)

\_\_\_\_\_  
(Signature and Title)

\_\_\_\_\_  
(Company Name)

\_\_\_\_\_  
(Signature and Title)

\_\_\_\_\_  
(Name of Surety) **(Affix Seal)**

\_\_\_\_\_  
(Signature of Attorney-in-Fact)

**NOTARY FOR PRINCIPAL**

**NOTARY FOR SURETY**

\_\_\_\_\_  
(Date)

\_\_\_\_\_  
(Date)

State of Wisconsin )  
 ) ss.  
\_\_\_\_\_ County )

State of Wisconsin )  
 ) ss.  
\_\_\_\_\_ County )

On the above date, this instrument was acknowledged before me by the named person(s).

On the above date, this instrument was acknowledged before me by the named person(s).

\_\_\_\_\_  
(Signature, Notary Public, State of Wisconsin)

\_\_\_\_\_  
(Signature, Notary Public, State of Wisconsin)

\_\_\_\_\_  
(Print or Type Name, Notary Public, State of Wisconsin)

\_\_\_\_\_  
(Print or Type Name, Notary Public, State of Wisconsin)

\_\_\_\_\_  
(Date Commission Expires)

\_\_\_\_\_  
(Date Commission Expires)

**Notary Seal**

**Notary Seal**

**IMPORTANT: A certified copy of Power of Attorney of the signatory agent must be attached to the bid bond.**



# CERTIFICATE OF ANNUAL BID BOND

DT1305 8/2003

Wisconsin Department of Transportation

Time Period Valid (From/To)
Name of Surety
Name of Contractor
Certificate Holder Wisconsin Department of Transportation

This is to certify that an annual bid bond issued by the above-named Surety is currently on file with the Wisconsin Department of Transportation.

This certificate is issued as a matter of information and conveys no rights upon the certificate holder and does not amend, extend or alter the coverage of the annual bid bond.

**Cancellation:** Should the above policy be cancelled before the expiration date, the issuing surety will give thirty (30) days written notice to the certificate holder indicated above.

\_\_\_\_\_  
(Signature of Authorized Contractor Representative)

\_\_\_\_\_  
(Date)





**DECEMBER 2000**

**CERTIFICATION REGARDING DEBARMENT, SUSPENSION, AND OTHER  
RESPONSIBILITY MATTERS - PRIMARY COVERED TRANSACTIONS**

Instructions for Certification

1. By signing and submitting this proposal, the prospective contractor is providing the certification set out below.
2. The inability of a person to provide the certification required below will not necessarily result in denial of participation in this covered transaction. The prospective contractor shall submit an explanation of why it cannot provide the certification set out below. The certification or explanation will be considered in connection with the department or agency's determination whether to enter into this transaction. However, failure of the prospective contractor to furnish a certification or an explanation shall disqualify such person from participation in this transaction.
3. The certification in this clause is a material representation of fact upon which reliance was placed when the department determined to enter into this transaction. If it is later determined that the contractor knowingly rendered an erroneous certification in addition to other remedies available to the Federal Government the department may terminate this transaction for cause or default.
4. The prospective contractor shall provide immediate written notice to the department to whom this proposal is submitted if at any time the prospective contractor learns that its certification was erroneous when submitted or has become erroneous by reason of changed circumstances.
5. The terms "covered transaction," "debarred," "suspended," "ineligible," "lower tier covered transaction," "participant," "person," "primary covered transaction," "principal," "proposal," and "voluntarily excluded," as used in this clause, have the meanings set out in the Definitions and Coverage sections of the rules implementing Executive Order 12549. You may contact the department to which this proposal is being submitted for assistance in obtaining a copy of those regulations.
6. The prospective contractor agrees by submitting this proposal that, should this contract be entered into, it shall not knowingly enter into any lower tier covered transaction with a person who is debarred, suspended, declared ineligible, or voluntarily excluded from participation in this covered transaction, unless authorized by the department entering into this transaction.
7. The prospective contractor further agrees by submitting this proposal that it will include the clause titled "Certification Regarding Debarment, Suspension, Ineligibility and Voluntary Exclusion-Lower Tier Covered Transaction," which is included as an addendum to PR-1273 - "Required Contract Provisions Federal Aid Construction Contracts," without

modification, in all lower tier covered transactions and in all solicitations for lower tier covered transactions.

8. The contractor may rely upon a certification of a prospective subcontractor/materials supplier that it is not debarred, suspended, ineligible, or voluntarily excluded from the covered transaction, unless it knows that the certification is erroneous. A contractor may decide the method and frequency by which it determines the eligibility of its principals. Each contractor may, but is not required to, check the Disapproval List (telephone # 608/266/1631).
9. Nothing contained in the foregoing shall be construed to require establishment of a system of records in order to render in good faith the certification required by this clause. The knowledge and information of a contractor is not required to exceed that which is normally possessed by a prudent person in the ordinary course of business dealings.
10. Except for transactions authorized under paragraph 6 of these instructions, if a contractor in a covered transaction knowingly enters into a lower tier covered transaction with a person who is suspended, debarred, ineligible or voluntarily excluded from participation in this transaction, in addition to other remedies available to the Federal Government, the department may terminate this transaction for cause or default.

Certification Regarding Debarment, Suspension, and Other Responsibility Matters - Primary Covered Transactions

- (1) The prospective contractor certifies to the best of its knowledge and belief, that it and its principals:
  - (a) Are not presently debarred, suspended, proposed for debarment, declared ineligible, or voluntarily excluded from covered transactions by any Federal department or agency;
  - (b) Have not within a three-year period preceding this proposal been convicted of or had a civil judgment rendered against them for commission of fraud or a criminal offense in connection with obtaining, attempting to obtain, or performing a public (Federal, State or local) transaction or contract under a public transaction; violation of Federal or State antitrust statutes or commission of embezzlement, theft, forgery, bribery, falsification or destruction of records, making false statements or receiving stolen property;
  - (c) Are not presently indicted for or otherwise criminally or civilly charged by a governmental entity (Federal, State or local) with commission of any of the offense enumerated in paragraph (1)(b) of this certification; and
  - (d) Have not within a three-year period preceding this proposal had one or more public transactions (Federal, State or local) terminated for cause or default.
- (2) Where the prospective contractor is unable to certify to any of the statements in this certification, such prospective contractor shall attach an explanation to this proposal.

## Special Provisions

### Table of Contents

Article	Description	Page #
1.	General.....	3
2.	Scope of Work.....	3
3.	Prosecution and Progress.....	3
4.	Traffic.....	5
5.	Holiday and Special Event Work Restrictions.....	6
6.	Utilities.....	7
7.	Work By Others.....	10
8.	Hauling Restrictions.....	10
9.	Public Convenience and Safety.....	10
10.	Municipality Acceptance of Sanitary Sewer and Water Main Construction.....	10
11.	Referenced Construction Specifications.....	10
12.	Dust Abatement.....	11
13.	Coordination with Businesses and Residents.....	11
14.	General Provisions for Storm Sewer.....	11
15.	Inlet Covers.....	12
16.	Removing Signs and Removing Small Sign Supports.....	12
17.	Reconnect Storm Sewer Laterals, Item SPV.0060.01.....	12
18.	Concrete Pipe Support, SPV.0060.02.....	12
19.	Remove Ex. Sanitary Manhole, Item SPV.0060.03; Remove Ex. Sanitary Vault Structure, SPV.0060.04; Remove Ex. Water Valve Box, Item SPV.0060.05; Remove Ex. Hydrant, Item SPV.0060.06.....	13
20.	Adjust Ex. Water Valve Box, Item SPV.0060.07; Adjust Ex. Curb Stop Box, Item SPV.0060.08.....	13
21.	Sanitary Manhole (48 Inch), Item SPV.0060.09; Sanitary Manhole (60 Inch), Item SPV.0060.10; Sanitary Drop Manhole (48 Inch), Item SPV.0060.11; Sanitary Drop Manhole, (60 Inch), Item SPV.0060.12.....	14
22.	Sanitary MH Cover Type J-Special, Item SPV.0060.13.....	14
23.	Connect To Existing Sanitary Sewer, Item SPV.0060.14.....	15
24.	Sanitary Wye 30-Inch Main, Item SPV.0060.15; Sanitary Wye 24-Inch Main, Item SPV.0060.16.....	15
25.	Sanitary Lateral Reconnection, Item SPV.0060.17.....	16
26.	Water Valve & Box 6-Inch, Item SPV.0060.18; Water Valve & Box 8-Inch, Item SPV.0060.19; Water Valve & Box 10-Inch, Item SPV.0060.20.....	16
27.	Fire Hydrant, Item SPV.0060.21.....	16
28.	Cross 8"x8" Special, Item SPV.0060.22.....	17
29.	Tees 8"x6"x8" Special, Item SPV.0060.23; Tees 8"x8"x8" Special, Item SPV.0060.24; Tees 10"x6"x10", Special, Item SPV.0060.25; Tees 10"x10"x10", Special, Item SPV.0060.26.....	17
30.	Bend 11.25-Degree 8-Inch Special, Item SPV.0060.27; Bend 11.25-Degree 10-Inch Special, Item SPV.0060.28; Bend 45-Degree 4-Inch Special, Item SPV.0060.29; Bend 45-Degree 6-Inch Special, Item SPV.0060.30; Bend 45-Degree 8-Inch Special, Item SPV.0060.31; Bend 45-Degree 10-Inch Special, Item SPV.0060.32; Bend 90-Degree 6-Inch Special, Item SPV.0060.33.....	18

31.	Reducer 8"x4" Special, Item SPV.0060.34; Reducer 8"x6" Special, Item SPV.0060.35; Reducer 10"x8" Special, Item SPV.0060.36.....	18
32.	Connect to Existing Watermain, Item SPV.0060.37.....	19
33.	Corporation, Curb Stop & Box (Set), Item SPV.0060.38.....	19
34.	Water Service Reconnection, Item SPV.0060.39.....	20
35.	Utility Line Opening (ULO), Item SPV.0060.40.....	20
36.	Inlet Cover Type Driveway Special, Item SPV.0060.41.....	21
37.	Temporary Water Service Project 6995-00-14, Item SPV.0060.42; Abandon/Remove Sanitary Sewer Project 6995-00-14, Item SPV.0060.43; Abandon/Remove Water Main Project 6995-00-14, Item SPV.0060.44.....	21
38.	Sanitary Sewer Pipe 8-Inch Special, Item SPV.0090.01; Sanitary Sewer Pipe 10-Inch Special, Item SPV.0090.02; Sanitary Sewer Pipe 24-Inch Special, Item SPV.0090.03; Sanitary Sewer Pipe 30-Inch Special, Item SPV.0090.04.....	21
39.	Sanitary Lateral 6-Inch Item SPV.0090.05.....	22
40.	Sanitary Sewer Televising, Item SPV.0090.06.....	22
41.	PVC Water Main 4-Inch Special, Item SPV.0090.07; PVC Water Main 6-Inch Special, Item SPV.0090.08; PVC Water Main 8-Inch Special, Item SPV.0090.09; PVC Water Main 10-Inch Special, Item SPV.0090.10.....	23
42.	Water Service 1 to 2-Inch Special, Item SPV.0090.11.....	23

## STSP'S Revised July 8, 2021

### SPECIAL PROVISIONS

#### 1. General.

Perform the work under this construction contract for Projects 6995-00-13 and 6995-00-14, C Beaver Dam, East Davis Street, S. Spring Street to S. University Ave, Local Street, Dodge County, Wisconsin as the plans show and execute the work as specified in the State of Wisconsin, Department of Transportation, Standard Specifications for Highway and Structure Construction, 2022 Edition, as published by the department, and these special provisions.

If all or a portion of the plans and special provisions are developed in the SI metric system and the schedule of prices is developed in the US standard measure system, the department will pay for the work as bid in the US standard system.

100-005 (20210708)

#### 2. Scope of Work.

The work under this contract shall consist of base aggregate, concrete pavement, storm sewer, sanitary sewer, water main, curb and gutter, sidewalk, permanent signing and marking, and all incidental items necessary to complete the work as shown on the plans and included in the proposal and contract.

104-005 (20090901)

#### 3. Prosecution and Progress.

Begin work within 10 calendar days after the engineer issues a written notice to do so.

Provide the start date to the engineer in writing within a month after executing the contract but at least 14 calendar days before the preconstruction conference. Upon approval, the engineer will issue the notice to proceed within 10 calendar days before the approved start date.

To revise the start date, submit a written request to the engineer at least two weeks before the intended start date. The engineer will approve or deny that request based on the conditions cited in the request and its effect on the department's scheduled resources.

The engineer will issue the notice to proceed by April 4, 2022.

##### A General

Have a superintendent or designated representative from the prime contractor on the job site during all controlling work operations, including periods limited to only subcontractor work operations, to serve as a primary contact person and to coordinate all work operations.

Hold prosecution and progress meetings once per week. Invite City of Beaver Dam representatives to attend the prosecution and progress meetings, including area EMS services. The prime contractor's superintendent or designated representative and subcontractor's representatives for ongoing subcontract work or subcontractor work expected to begin within the next two weeks shall provide a written schedule of the next week(s)' operations. Provide begin and end dates of specific prime and subcontractor work operations. Review the contractor's schedule and subcontractors' schedule, traffic control staging, and evaluation of progress and pay items and other agenda items at the meeting. Review plans, schedule and specifications for upcoming work at this meeting.

The contractor is advised to mobilize construction equipment that is a size suitable for maneuvering in the limited area throughout the project. There are many movement limitations both horizontally and vertically in the project limits (trees, overhead wires, poles, etc.). The contractor shall be responsible for any damage done to objects inside the project limits.

The contractor is advised that there may be multiple mobilizations for such items as traffic control, signing and pavement marking items and other items related to the construction. The department will make no additional payment for said mobilizations.



Place base aggregate dense on the same day as excavation and provide ramps to driveway and side road entrances by the end of each day. The cost of this work is included in the bid item that is being worked on at the time.

Minimize the amount of dust created from construction. During construction operations, if aggregate, slurry from saw cutting, or other construction materials are in the travel way, the contractor shall immediately clean up the area. Water is included as part of the project to assist with dust abatement during construction.

Protect all building faces from damage, dirt, and concrete. When doing work near buildings, put a shield (plywood, sheeting, etc.) up against the building to protect it. The cost of this work is included in the bid item that is being worked on at the time. Return the building face to its original condition if any damage occurs or if any dirt or concrete has adhered to the building face.

Do not commence utility work, disrupt a utility, or commence sidewalk construction in front of an entrance without notifying the property owner or business a minimum of 48 hours in advance. Do not shut off utilities or entrances to businesses during the business open times unless approved by the engineer.

No driveway construction can commence at an entrance without notifying the property owner or business a minimum of 48 hours in advance.

Allow access for businesses, residents, garbage trucks, and postal services to be maintained to the greatest extent practicable during construction. Temporary business and residential access closures are allowed for up to 14 calendar days following the date of concrete pavement, curb/gutter, and/or driveway pours to allow for concrete curing time; however, stage construction in a manner to allow garbage trucks, postal, police and EMS services access to the project corridor during the concrete curing time period. Inform businesses and residents a minimum of 48 hours prior to closing their driveway access.

Do not store equipment, vehicles, or materials on adjacent streets beyond the project limits without specific approval of the engineer.

If this project will involve cutting or wounding of oak trees, avoid cutting or pruning of oaks from April through September to prevent the spread of oak wilt disease.

### **Northern Long-eared Bat (*Myotis septentrionalis*)**

Northern Long-eared Bats (NLEB) have the potential to inhabit the project limits because they roost in trees. Roosts may not have been observed on this project, but conditions to support the species exist. The species and all active roosts are protected by the Federal Endangered Species Act. If an individual bat or active roost is encountered during construction operations, stop work and notify the engineer and the WisDOT Regional Environmental Coordinator (REC).

According to the final 4(d) rule issued for the NLEB, the department has determined that the proposed activity may affect, but will not result in prohibited take of the NLEB. The activity involves tree removal but will not occur within 0.25 miles of a known hibernacula, nor will the activity remove a known maternity roost tree or any other tree within 150 feet of a known maternity roost tree.

If additional trees need to be removed, no Clearing shall occur without prior approval from the engineer, following coordination with the WisDOT REC. Additional tree removal beyond the area originally specified will require consultation with the United States Fish and Wildlife Service (USFWS) and may require a bat presence/absence survey. Notify the engineer if additional Clearing cannot be avoided to begin coordination with the WisDOT REC. The WisDOT REC will initiate consultation with the USFWS and determine if a survey is necessary.

Submit a schedule and description of Clearing operations with the ECIP 14 days prior to any Clearing operations. The department will determine, based on schedule and scope of work, what additional erosion control measures shall be implemented prior to the start of Clearing operations, and list those additional measures in the ECIP.

### **Federal Aviation Administration**

The FAA conducted an aeronautical determination filing under the provisions of 49 U.S.C., Section 44718 for this project.

Aeronautical determination filing number 2020-AGL-16797-OE was issued on June 18, 2020 to the project for the roadway reconstruction. The initial determination states the reconstruction activities and equipment does not exceed the obstruction standards and would not be a hazard for air navigation.

Renew the determination a minimum of 45 days prior to construction. E-file FAA Form 7460-2 a minimum of 5 days after construction reaches its greatest height.

#### **4. Traffic.**

##### **A General**

East Davis Street, within the project limits will be closed to through traffic. A detour route will be posted and will utilize Spring Street, Stone Street, and University Avenue.

##### **B Private Access Maintenance**

Maintain local vehicular access at all times to all driveways and side roads throughout construction, except during paving and utility installation operations occurring in the immediate vicinity of the access point. When access must be limited due to construction operations, notify the engineer, property owners, and occupants at least 48 hours prior to the beginning of the construction operation. Complete the work in a reasonable time and manner to resume access to the driveway or side road.

Maintain local and emergency access to adjacent properties to and from the work zone at all times unless otherwise approved by the engineer. An undistributed amount of base aggregate is provided for maintenance of local traffic within the work areas.

Maintain emergency vehicle access and delivery vehicle access at all times to all properties throughout construction; except during paving and utility installation operations occurring in the immediate vicinity of the property. When access must be limited due to construction operations, notify the police and fire departments, the engineer, property owners and occupants at least 48 hours prior to the beginning of the construction operation. Complete the work in a reasonable time and manner to resume access to the property.

Notify the property resident a minimum of 48 hours in advance of driveway reconstruction to verify closure or staged driveway construction methods. Coordinate with each business for the best time to construct driveways and sidewalks so as not to interrupt business operations during open hours. Construct driveway approaches to commercial properties in stages if the property does not have an alternate access available so that at least one access is maintained to each business at all times.

For vehicle access, furnish, construct, and maintain a ramp of compacted base aggregate dense between closed side streets or open cross streets or driveway access and the work zone at all times, including down to excavated subgrade. The maximum ramp slope shall be 12% and delineated with traffic control drums. Use drums or barricades to direct vehicular traffic in the work zone if required by the engineer."

Allow access for residents, garbage trucks, and postal services to be maintained to the greatest extent practicable during construction. Temporary property access closures are allowed for up to 14 calendar days following the date of concrete pavement, curb/gutter, and/or driveway pours to allow for concrete curing time; however, stage construction in a manner to allow garbage trucks, postal, police and EMS services access to the project corridor during the concrete curing time period. Inform residents a minimum of 48 hours prior to closing their driveway access.

Coordinate with the City of Beaver Dam to provide access for garbage collection. Contact Todd Janssen, Director of Engineering at (920) 887-4600, Ext. 326.

Use drums, barricades, flexible tubular markers, and safety fence to direct vehicular and pedestrian traffic in the work zone. Protect and delineate hazards such as open excavations, abrupt drop-offs, and exposed manholes, inlets, and hydrants, with wedged material, drums, barricades, and safety fence as shown in the plans, special provisions, or as directed by the engineer.

##### **C Advanced Notification-Street Closure**

Notify the City of Beaver Dam Police Department, City of Beaver Dam Fire Department, City of Beaver Dam Director of Engineering (Todd Janssen), United States Post Office/Post Master, Beaver Dam Unified School District, Beaver Dam Community Hospital, and all other businesses/property owners/occupants within the project corridor a minimum of 14 calendar days prior to closing East Davis Street.

##### **D Intersection Closure**

All intersections within the project limits are closed to through traffic. Maintain local access by providing a single 14-foot wide accessible traffic route across Lincoln Street and Roedl Court at all times. Provide two-way stop control for side streets at East Davis Street if existing signage has already been removed.

University Avenue may be closed for a maximum of 5 days each for sewer and water connections in the intersection and for final concrete paving. A short term detour route is included in the plans. Maintain access to both entrances to the Beaver Dam Community Hospital on University Avenue and Webster Street.

## **E Pedestrian Access**

The pedestrian detour route will utilize the same route as traffic and included in the plans for the closure of East Davis Street. Set and maintain this detour in conjunction with the closure of East Davis Street to through vehicle traffic. Maintain access for local pedestrian traffic within the work zone on a paved surface on a minimum of one side of East Davis Street at all times. Paved surface includes existing sidewalk, a temporary pedestrian surface, or finished concrete sidewalk as shown in the plans.

Maintain pedestrian access to residences, businesses, parking lots, and schools or provide where necessary, as directed by the engineer. Provide a temporary surface for pedestrian access at all times in areas of sidewalk construction. Construct the temporary pedestrian surface to meet Americans with Disabilities Act Accessibility Guidelines (ADAAG) requirements consisting of temporary pedestrian surface asphalt, temporary pedestrian surface plywood, temporary pedestrian surface plate, or alternative material as approved by the engineer. Gravel or base course material is not acceptable. Maintain ADAAG accessible pedestrian access surfaces and walkways that are free from mud, sand, and construction debris.

When the remaining sidewalks need to be removed for replacement, the contractor shall have the base course material leveled and compacted in the removal areas within 24 hours, and the new concrete Pedestrian Access must be maintained at all times during construction using a combination of existing pavement, new pavement or Temporary Pedestrian Surface Asphalt and existing curb ramps or Temporary Curb Ramps that meet ADA requirements and standard detail drawings.

The temporary pedestrian surface shall have vertical joints no higher than 1/4 inch and horizontal joints no wider than 1/2 inch.

Provide a minimum of one crosswalk access across East Davis Street at the intersections of Lincoln Avenue, Jefferson Street, and Roedl Court or as directed by the engineer. Crosswalk access shall be maintained at all times.

Provide temporary crosswalk access across closed side streets, outside the work zone, at all times as detailed in the plans and directed by the engineer. Furnish and install Temporary Curb Ramps at the crosswalk location.

Furnish and install Temporary Pedestrian Safety Fence along existing and temporary sidewalk surface where there are drop-offs greater than 6-inches within 1-foot of the sidewalk edge and an earth barrier does not exist to delineate the edge of sidewalk for vision impaired pedestrians.

Traffic Control Drums or barrels are not suitable for guidance along pedestrian access routes.

If additional special pedestrian access needs are identified along the project, provide for that access as directed by the engineer.

## **5. Holiday and Special Event Work Restrictions.**

Do not perform work on, nor haul materials of any kind along or across any portion of the highway carrying East Davis Street traffic, and entirely clear the traveled way and shoulders of such portions of the highway of equipment, barricades, signs, lights, and any other material that might impede the free flow of traffic during the following holiday and special event periods:

- From noon Friday, May 27, 2022 to 6:00 AM Tuesday, May 31, 2022 for Memorial Day;
- From noon Friday, July 1, 2022 to 6:00 AM Tuesday, July 5, 2022 for Independence Day;
- From noon Friday, September 2, 2022 to 6:00 AM Tuesday, September 6, 2022 for Labor Day.

stp-107-005 (20210113)

## 6. Utilities.

This contract does not come under the provision of Administrative Rule Trans 220.

stp-107-066 (20080501)

Within the limits of this project there are underground and aerial facilities. Coordinate construction activities with a call to Diggers Hotline, and/or a direct call to the utilities for the underground facilities in the area as required per statutes. Use caution to ensure the integrity of underground facilities and maintain OSHA code clearances from overhead facilities at all times.

### **Project 6995-00-13**

Within the limits of this project there are underground and aerial facilities. Coordinate construction activities with a call to Diggers Hotline, and/or a direct call to the utilities for the underground facilities in the area as required per statutes. Use caution to ensure the integrity of underground facilities and maintain OSHA code clearances from overhead facilities at all times.

#### **Alliant Energy (Electric)**

Overhead facilities (main 3 phase feeder) run along the northern terrace of East Davis Street between the existing curb and gutter and sidewalk from Spring Street to Lincoln Avenue. At Lincoln Avenue it crosses to the south and continues until Jefferson Street where it crosses back to the north to University Avenue. Services cross East Davis Street throughout the project corridor.

The following poles conflict with the proposed sidewalk or curb and gutter and will be relocated out of conflict while maintaining lateral clearance (2.0' offset from the face of curb).

Full Description	Station	Offset	Conflict
Pole#1	23+44	16' LT	Yes
Pole#2	23+82	20' RT	Yes
Pole#3	24+39	16' LT	Yes
Pole#6	25+61	16' LT	Yes
Pole#8	26+60	16' LT	Yes
Pole#9	26+93	21' RT	Yes
Pole#10	27+88	17' LT	Yes
Pole#12	29+17	24' LT	Yes
Pole#13	29+62	22' RT	Yes
Pole#14	30+26	23' RT	Yes
Pole#15	31+31	23' RT	Yes
Pole#16	31+37	23' RT	Yes
Pole#17	32+50	23' RT	Yes
Pole#18	33+06	22' RT	Yes
Pole#19	33+84	16' LT	Yes
Pole#20	34+98	15' LT	Yes
Pole#23	36+62	23' RT	Yes

Full Description	Station	Offset	Conflict
Pole#24	38+30	15' LT	Yes
Pole#25	39+88	22' LT	Yes
Pole#26	40+22	24' LT	Yes
Pole#27	41+34	13' LT	Yes
Pole#28	42+04	15' LT	Yes
Pole#31	44+48	16' LT	Yes

The remaining poles are not in conflict with the proposed sidewalk or curb and gutter and are anticipated to remain in place or be adjusted to meet lateral clearance requirements (2.0' offset from the face of curb).

Full Description	Station	Offset	Conflict
Pole#4	24+64	16' LT	No
Pole#5	25+22	21' RT	No
Pole#7	25+94	22' RT	No
Pole#11	28+11	21' RT	No
Pole#21	35+04	22' RT	No
Pole#22	36+56	14' LT	No
Pole#29	43+12	14' LT	No
Pole#30	43+91	22' RT	No

Alliant Energy will complete work to relocate poles that are directly in conflict with the curb and gutter and sidewalk within the proposed terrace. Upon relocation, all poles within the project limits will be within 3' clearance to the curb and gutter but will maintain the lateral clearance (2.0' offset from the face of curb).

The poles will be relocated within the proposed terrace between January and February 2022, prior to construction.

### **Alliant Energy (Gas)**

Buried 6" plastic gas runs along the southern terrace between the existing curb and gutter and sidewalk along East Davis Street between Spring Street and University Avenue. Services cross East Davis Street throughout the project corridor.

The gas main will remain in place for the majority of the project. Conflicts are anticipated at several new storm sewer structures throughout the project corridor. Gas facilities will be relocated under the sidewalk at conflict locations with storm sewer structures. Service laterals will remain in their present location, however, can be rerouted to create clearance for proposed storm sewer. A portion of the gas facility relocations may be able to take place prior to construction. For gas facilities that will take place during construction, this will occur after completion of water main and sanitary sewer, prior to the installation of storm sewer. Notify Alliant Energy to beginning the sanitary sewer and water main work to coordinate any remaining conflict resolutions during construction. The gas relocation work is anticipated to take 1-2 weeks to complete.

## **AT&T**

AT&T has overhead facilities along the south side of East Davis Street between Spring Street and Jefferson Street. There are AT&T and Alliant poles within the segment. AT&T also has buried and overhead facilities that cross East Davis along the western side of University Avenue.

AT&T will relocate their facilities to new Alliant Energy poles. This work is anticipated to take 20 working days which would start after Alliant Energy establishes new pole locations. Service lines that have been discontinued that cross E. Davis Street to the pole line on the north will be removed. This will be completed prior to the start of construction.

## **Charter Communications**

Charter Communications has overhead facilities between Spring Street and University Avenue located on Alliant Energy poles.

Charter will relocate their facilities to new Alliant Energy poles. This work is anticipated to start after Alliant Energy establishes new pole locations. This will be completed prior to the start of construction.

## **City of Beaver Dam – Beaver Dam Utilities – Sanitary Sewer**

City of Beaver Dam has existing sanitary sewer throughout the project. The sanitary sewer will be replaced as part of this project. Beaver Dam Utilities contact for sanitary sewer work is:

Rob Minnema, Director of Utilities  
Office: (920) 887-4625  
Cell: (920) 382-5245  
Email: [rminnema@cityofbeaverdam.com](mailto:rminnema@cityofbeaverdam.com)

Alternate Contact:  
Jeremy Klug, Utility Superintendent  
Cell: (920) 763-7077  
Email: [jklug@cityofbeaverdam.com](mailto:jklug@cityofbeaverdam.com)

## **City of Beaver Dam – Beaver Dam Utilities – Water Main**

City of Beaver Dam has existing water main throughout the project. The water main will be replaced as part of this project. Beaver Dam Utilities contact for water main work is:

Rob Minnema, Director of Utilities  
Office: (920) 887-4625  
Cell: (920) 382-5245  
Email: [rminnema@cityofbeaverdam.com](mailto:rminnema@cityofbeaverdam.com)

Alternate Contact:  
Jeremy Klug, Utility Superintendent  
Cell: (920) 763-7077  
Email: [jklug@cityofbeaverdam.com](mailto:jklug@cityofbeaverdam.com)

## **Windstream**

Windstream has overhead facilities between Spring Street and University Avenue located on Alliant Energy poles.

Windstream will relocate their facilities to new Alliant Energy poles. This work is anticipated to be completed prior to the start of construction.

## **Project 6995-00-14**

All coordination was completed under Project 6995-00-14.

## **7. Work By Others.**

The City of Beaver Dam has a let contract to reconstruct the private side of the sanitary lateral and water services along East Davis Street from a point near the right-of-way to the house. Homeowners also have the option of hiring out their own contractor to do the work.

Anticipated construction operations for this work will begin before construction operations on East Davis Street and will continue throughout construction. Coordinate project work activities with Rob Minnema, City of Beaver Dam Director of Utilities, (920) 887-4625 and other private contractors to minimize disruptions to individual projects, the traveling public, and local residents.

### **Beaver Dam Unified School District**

Beaver Dam Unified School District has buried fiber optic that runs along East Davis Street behind the existing sidewalk between Lincoln Avenue and Jefferson Street.

There are no conflicts anticipated with Beaver Dam Unified School District facilities within the project limits.

## **8. Hauling Restrictions**

At all times, conduct operations in a manner that will cause a minimum of inconvenience to the free flow of traffic on adjacent and intersecting streets. Hauling vehicles shall only use engineer-approved ingress and egress locations. Use only City of Beaver Dam designated truck routes for material haul roads. Haul roads are detailed in standard spec 618. Todd Janssen, City of Beaver Dam Engineer, (920) 356-2543, for information on the City of Beaver Dam designated truck routes.

Equip all vehicles traveling on public roads that are hauling materials or removals and are subject to spillage, by either wind or vibration, with tailgates and adequate sideboards. Use canvas covers and any other protective devices to prevent spillage as determined necessary by the engineer. Comply with all local ordinances.

## **9. Public Convenience and Safety.**

*Revise standard spec 107.8(6) as follows:*

Check for and comply with local ordinances governing the hours of operation of construction equipment. Do not operate motorized construction equipment from 7:00 PM until the following 7:00 AM, unless prior written approval is obtained from the engineer.

stp-107-001 (20060512)

## **10. Municipality Acceptance of Sanitary Sewer and Water Main Construction.**

Beaver Dam Utilities personnel or its designated representatives will observe and inspect the construction of the sanitary sewer and water main under this contract. Compliance testing shall be performed by the contractor in the presence of Beaver Dam Utilities personnel or its designated representatives.

Construction Staking will be done by the City of Beaver Dam personnel or its designated representatives. Final acceptance of the sanitary sewer and water main construction will be by the Beaver Dam Utilities personnel.

## **11. Referenced Construction Specifications**

Construct the work enumerated below conforming to the Standard Utilities and WIDNR SDWLP and CWFP Funding Specifications for WisDOT Let Projects, City of Beaver Dam. If there is a discrepancy or conflict between the referenced specification and the standard specifications regarding contract administration, part 1 of the standard specifications governs.

Conform to the referenced construction specifications for the following:

- Water Main construction
- Sanitary Sewer construction

An emailed electronic copy of the "Standard Utilities and WIDNR SDWLP and CFWP Funding Specifications for WisDOT Let Projects, City of Beaver Dam" may be obtained from the City of Beaver Dam's Project Representative, Nate Rego, MSA Professional Services, Inc. at (920) 392-5135 or [nrego@msa-ps.com](mailto:nrego@msa-ps.com). A copy of these specifications is also available for viewing during normal business hours at the City of Beaver Dam, City Hall, 205 S Lincoln Avenue, Beaver Dam, Wisconsin (phone ahead: (920) 887-4600).

## **12. Dust Abatement.**

*Add the following to standard spec 107.18(2):*

Dry brooming of the pavement will not be allowed.

When engaged in roadway cleaning operations, use equipment having vacuum or water spray mechanisms to eliminate the dispersion of particulate matter into the atmosphere. If vacuum equipment is employed, it must have a suitable self-contained particulate collector to prevent discharge from the collection bin into the atmosphere.

## **13. Coordination with Businesses and Residents.**

The contractor shall arrange and conduct a meeting between the contractor, the department, affected residents, local officials and business people to discuss the project schedule of operations including vehicular and pedestrian access during construction operations. Hold the first meeting at least one week before the start of work under this contract and hold two meetings per month thereafter. The contractor shall arrange for a suitable location for meetings that provides reasonable accommodation for public involvement. The contractor will prepare and coordinate publication of the meeting notices and mailings for meetings. The contractor shall schedule meetings with at least two weeks' prior notice to the engineer to allow for these notifications.

stp-108-060 (20141107)

## **14. General Provisions for Storm Sewer**

Construct all round and elliptical shape storm sewers and catch basins, manholes, and inlets according to the pertinent provisions of standard spec 608, 610 and 611 as shown on the plans, and as follows.

Precompressed butyl gasket (E-Z Stik or approved equal) shall be used between the storm inlet, inlet casting, and all adjustment rings. Mortar shall not be used between these structures for adjustment; however, mortar shall be used to provide a smooth trowel type finish to the interior surface of the joints between the manhole, adjusting rings and casting.

Concrete mortar shall be installed between the pipe and the manhole cut-out to the satisfaction of the engineer so as to fill any gaps and finish the interior flowline of the manhole.

Seal the joints for reinforced concrete pipe with either mastic or internal rubber gaskets as described in standard spec 607.3.4. The use of mortar as a pipe joint method is prohibited.

Dewatering trenches shall be incidental to the unit price for all storm sewer pipe installation.

Do not use station and offset for inlet structures, as given on the storm plans, for final layout of the structure. Determine the curb line in the area of the inlet prior to pouring or setting the inlet structure to assure proper location of the inlet relative to the curb line.



**15. Inlet Covers.**

*Supplement standard spec 611.3.6.1 with the following:*

Inlet Covers Type H and H-S will be required to have the wording “DUMP NO WASTE, DRAINS TO LAKE” on the curb head portion of the casting. It is required that the lettering be a minimum 2 inches in height. The lettering must also be raised a minimum of 1/8 inch, but not exceed ¼ inch above the curb head. Lettering will be read from the street.

**16. Removing Signs and Removing Small Sign Supports.**

*Replace standard spec 638.3.4(2) with the following:*

Return Type II signs and sign supports to the city garage, 640 S. Center Street, Beaver Dam, WI. Prior to delivery, contact Todd Janssen, City of Beaver Dam Engineer, (920) 356-2543 to schedule delivery and to allow city personnel to inspect the materials and determine which are suitable to be delivered. Remove any signs and sign supports the city does not want and all other material from the right-of-way and dispose of them.

**17. Reconnect Storm Sewer Laterals, Item SPV.0060.01.**

**A Description**

This special provision describes reconnecting existing storm sewer laterals to new structures or existing pipe.

**B Materials**

Provide culvert pipe concrete collars according to standard spec 520.2.4.

Provide couplings that meet standard spec 608.2.

**C Construction**

Identify all private laterals in existing structures prior to that structure’s removal. Remove existing lateral pipes to the next good joint and replace in-kind. Verify that positive drainage is achieved when connecting to the new inlet or curb outlet structure. The contractor will be allowed to salvage any structurally sound pipe that was removed with prior approval by the engineer. Connect the existing pipes to the new pipes with the appropriate coupling, concrete collar or by means approved by the engineer. Any additional pipe or materials required to reconnect the storm sewer laterals are considered incidental to this bid item.

**D Measurement**

The department will measure Reconnect Existing Storm Sewer Lateral by each lateral connected, acceptably completed.

**E Payment**

The department will pay for measure quantities at the contract unit price under the following bid item:

ITEM NUMBER	DESCRIPTION	UNIT
SPV.0060.01	Reconnect Existing Storm Sewer Lateral	EACH

Payment is full compensation for removal of existing pipes, furnishing and installing all materials, couplings, concrete collars, and pipe.

**18. Concrete Pipe Support, SPV.0060.02.**

**A Description**

This special provision describes constructing a concrete masonry support between storm sewer and local utilities as detailed in the plans and as hereinafter specified.

**B Materials**

Furnish concrete materials conforming to standard spec 611.2.

Furnish granular backfill conforming to standard spec 209.2

**C Construction**

Construct according to the plans and standard spec 611.3.

**D Measurement**

The department will measure Concrete Support as each individual concrete support, acceptably completed.

**E Payment**

The department will pay for measured quantities at the contract unit price under the following bid item:

ITEM NUMBER	DESCRIPTION	UNIT
SPV.0060.02	Concrete Support	EACH

Payment is full compensation for providing all materials, including all masonry; for all excavating, backfilling, disposing of surplus material, insulation, concrete masonry, curing, protecting and for cleaning out and restoring the work site.

- 19. Remove Ex. Sanitary Manhole, Item SPV.0060.03;**
- Remove Ex. Sanitary Vault Structure, SPV.0060.04;**
- Remove Ex. Water Valve Box, Item SPV.0060.05;**
- Remove Ex. Hydrant, Item SPV.0060.06.**

**A Description**

This special provision describes Remove Ex. Sanitary Manhole, Remove Ex. Sanitary Vault Structure, Remove Ex. Water Valve Box, Remove Ex. Hydrant, according to the “Standard Utilities and WIDNR SDWLP and CWFP Funding Specifications for WisDOT Let Projects, City of Beaver Dam”.

**B (Vacant)**

**C (Vacant)**

**D Measurement**

The department will measure Remove Ex. Sanitary Manhole, Remove Ex. Sanitary Vault Structure, Remove Ex. Water Valve Box, Remove Ex. Hydrant by each unit, completed and accepted.

**E Payment**

The department will pay for measured quantities at the contract unit price under the following bid item:

ITEM NUMBER	DESCRIPTION	UNIT
SPV.0060.03	Remove Ex. Sanitary Manhole	EACH
SPV.0060.04	Remove Ex. Sanitary Vault Structure	EACH
SPV.0060.05	Remove Ex. Water Valve Box	EACH
SPV.0060.06	Remove Ex. Hydrant	EACH

Payment is full compensation for all work herein specified according to the “Standard Utilities and WIDNR SDWLP and CWFP Funding Specifications for WisDOT Let Projects, City of Beaver Dam”.

- 20. Adjust Ex. Water Valve Box, Item SPV.0060.07;**
- Adjust Ex. Curb Stop Box, Item SPV.0060.08.**

**A Description**

This special provision describes Adjust Ex. Water Valve Box, Adjust Ex. Curb Stop Box, according to the “Standard Utilities and WIDNR SDWLP and CWFP Funding Specifications for WisDOT Let Projects, City of Beaver Dam”.

**B (Vacant)**

**C (Vacant)**

**D Measurement**

The department will measure Adjust Ex. Water Valve Box, Adjust Ex. Curb Stop Box by each unit, completed and accepted.

**E Payment**

The department will pay for measured quantities at the contract unit price under the following bid item:

ITEM NUMBER	DESCRIPTION	UNIT
SPV.0060.07	Adjust Ex. Water Valve Box	EACH
SPV.0060.08	Adjust Ex. Curb Stop Box	EACH

Payment is full compensation for all work herein specified according to the “Standard Utilities and WIDNR SDWLP and CWFP Funding Specifications for WisDOT Let Projects, City of Beaver Dam”.

- 21. Sanitary Manhole (48 Inch), Item SPV.0060.09;**
- Sanitary Manhole (60 Inch), Item SPV.0060.10;**
- Sanitary Drop Manhole (48 Inch), Item SPV.0060.11;**
- Sanitary Drop Manhole, (60 Inch), Item SPV.0060.12.**

**A Description**

This special provision describes Sanitary Manhole (48 Inch), Sanitary Manhole (60 Inch), Sanitary Drop Manhole (48 Inch), Sanitary Drop Manhole (60 Inch) according to the “Standard Utilities and WIDNR SDWLP and CWFP Funding Specifications for WisDOT Let Projects, City of Beaver Dam”.

**B (Vacant)**

**C (Vacant)**

**D Measurement**

The department will measure Sanitary Manhole (48 Inch), Sanitary Manhole (60 Inch), Sanitary Drop Manhole (48 Inch), Sanitary Drop Manhole (60 Inch) by each unit, completed and accepted.

**E Payment**

The department will pay for measured quantities at the contract unit price under the following bid item:

ITEM NUMBER	DESCRIPTION	UNIT
SPV.0060.09	Sanitary Manhole (48 Inch)	EACH
SPV.0060.10	Sanitary Manhole (60 Inch)	EACH
SPV.0060.11	Sanitary Drop Manhole (48 Inch)	EACH
SPV.0060.12	Sanitary Drop Manhole (60 Inch)	EACH

Payment is full compensation for all work herein specified according to the “Standard Utilities and WIDNR SDWLP and CWFP Funding Specifications for WisDOT Let Projects, City of Beaver Dam”.

- 22. Sanitary MH Cover Type J-Special, Item SPV.0060.13**

**A Description**

This special provision describes Sanitary MH Cover Type J-Special according to the “Standard Utilities and WIDNR SDWLP and CWFP Funding Specifications for WisDOT Let Projects, City of Beaver Dam”.

**B (Vacant)**

**C (Vacant)**

**D Measurement**

The department will measure Sanitary MH Cover Type J-Special by each unit, completed and accepted.

**E Payment**

The department will pay for measured quantities at the contract unit price under the following bid item:

ITEM NUMBER	DESCRIPTION	UNIT
SPV.0060.13	Sanitary MH Cover Type J- Special	EACH

Payment is full compensation for all work herein specified according to the “Standard Utilities and WIDNR SDWLP and CWFP Funding Specifications for WisDOT Let Projects, City of Beaver Dam”.

**23. Connect To Existing Sanitary Sewer, Item SPV.0060.14.**

**A Description**

This special provision describes Connect To Existing Sanitary Sewer according to the “Standard Utilities and WIDNR SDWLP and CWFP Funding Specifications for WisDOT Let Projects, City of Beaver Dam”.

**B (Vacant)**

**C (Vacant)**

**D Measurement**

The department will measure Connect To Existing Sanitary Sewer by each unit, completed and accepted.

**E Payment**

The department will pay for measured quantities at the contract unit price under the following bid item:

ITEM NUMBER	DESCRIPTION	UNIT
SPV.0060.14	Connect to Existing Sanitary Sewer	EACH

Payment is full compensation for all work herein specified according to the “Standard Utilities and WIDNR SDWLP and CWFP Funding Specifications for WisDOT Let Projects, City of Beaver Dam”.

**24. Sanitary Wye 30-Inch Main, Item SPV.0060.15;  
Sanitary Wye 24-Inch Main, Item SPV.0060.16.**

**A Description**

This special provision describes Sanitary Wye 30-Inch Main, Sanitary Wye 24-Inch Main according to the “Standard Utilities and WIDNR SDWLP and CWFP Funding Specifications for WisDOT Let Projects, City of Beaver Dam”.

**B (Vacant)**

**C (Vacant)**

**D Measurement**

The department will measure Sanitary Wye 30-Inch Main, Sanitary Wye 24-Inch Main by each unit, completed and accepted.

**E Payment**

The department will pay for measured quantities at the contract unit price under the following bid item:

ITEM NUMBER	DESCRIPTION	UNIT
SPV.0060.15	Sanitary Wye 30-Inch Main	EACH
SPV.0060.16	Sanitary Wye 24-Inch Main	EACH

Payment is full compensation for all work herein specified according to the “Standard Utilities and WIDNR SDWLP and CWFP Funding Specifications for WisDOT Let Projects, City of Beaver Dam”.

**25. Sanitary Lateral Reconnection, Item SPV.0060.17**

**A Description**

This special provision describes Sanitary Lateral Reconnection according to the “Standard Utilities and WIDNR SDWLP and CWFP Funding Specifications for WisDOT Let Projects, City of Beaver Dam”.

**B (Vacant)**

**C (Vacant)**

**D Measurement**

The department will measure Sanitary Lateral Reconnection by each unit, completed and accepted.

**E Payment**

The department will pay for measured quantities at the contract unit price under the following bid item:

ITEM NUMBER	DESCRIPTION	UNIT
SPV.0060.17	Sanitary Lateral Reconnection	EACH

Payment is full compensation for all work herein specified according to the “Standard Utilities and WIDNR SDWLP and CWFP Funding Specifications for WisDOT Let Projects, City of Beaver Dam”.

**26. Water Valve & Box 6-Inch, Item SPV.0060.18;  
Water Valve & Box 8-Inch, Item SPV.0060.19;  
Water Valve & Box 10-Inch, Item SPV.0060.20.**

**A Description**

This special provision describes Water Valve & Box 6-Inch, Water Valve & Box 8-Inch, Water Valve & Box 10-Inch according to the “Standard Utilities and WIDNR SDWLP and CWFP Funding Specifications for WisDOT Let Projects, City of Beaver Dam”.

**B (Vacant)**

**C (Vacant)**

**D Measurement**

The department will measure Water Valve & Box 6-Inch, Water Valve & Box 8-Inch, Water Valve & Box 10-Inch by each unit, completed and accepted.

**E Payment**

The department will pay for measured quantities at the contract unit price under the following bid item:

ITEM NUMBER	DESCRIPTION	UNIT
SPV.0060.18	Water Valve & Box 6-Inch	EACH
SPV.0060.19	Water Valve & Box 8-Inch	EACH
SPV.0060.20	Water Valve & Box 10-Inch	EACH

Payment is full compensation for all work herein specified according to the “Standard Utilities and WIDNR SDWLP and CWFP Funding Specifications for WisDOT Let Projects, City of Beaver Dam”.

**27. Fire Hydrant, Item SPV.0060.21.**

**A Description**

This special provision describes Fire Hydrant according to the “Standard Utilities and WIDNR SDWLP and CWFP Funding Specifications for WisDOT Let Projects, City of Beaver Dam”.

**B (Vacant)**

**C (Vacant)**

**D Measurement**

The department will measure Fire Hydrant by each unit, completed and accepted.

**E Payment**

The department will pay for measured quantities at the contract unit price under the following bid item:

ITEM NUMBER	DESCRIPTION	UNIT
SPV.0060.21	Fire Hydrant	EACH

Payment is full compensation for all work herein specified according to the “Standard Utilities and WIDNR SDWLP and CWFP Funding Specifications for WisDOT Let Projects, City of Beaver Dam”.

**28. Cross 8”x8” Special, Item SPV.0060.22.**

**A Description**

This special provision describes Cross 8”x8” Special according to the “Standard Utilities and WIDNR SDWLP and CWFP Funding Specifications for WisDOT Let Projects, City of Beaver Dam”.

**B (Vacant)**

**C (Vacant)**

**D Measurement**

The department will measure Cross 8”x8” Special by each unit, completed and accepted.

**E Payment**

The department will pay for measured quantities at the contract unit price under the following bid item:

ITEM NUMBER	DESCRIPTION	UNIT
SPV.0060.22	Cross 8”x8” Special	EACH

Payment is full compensation for all work herein specified according to the “Standard Utilities and WIDNR SDWLP and CWFP Funding Specifications for WisDOT Let Projects, City of Beaver Dam”.

**29. Tees 8”x6”x8” Special, Item SPV.0060.23;  
Tees 8”x8”x8” Special, Item SPV.0060.24;  
Tees 10”x6”x10”, Special, Item SPV.0060.25;  
Tees 10”x10”x10”, Special, Item SPV.0060.26.**

**A Description**

This special provision describes Tees 8”x6”x8” Special, Tees 8”x8”x8” Special, Tees 10”x6”x10” Special, Tees 10”x10”x10” Special according to the “Standard Utilities and WIDNR SDWLP and CWFP Funding Specifications for WisDOT Let Projects, City of Beaver Dam”.

**B (Vacant)**

**C (Vacant)**

**D Measurement**

The department will measure Tees 8”x6”x8” Special, Tees 8”x8”x8” Special, Tees 10”x6”x10” Special, Tees 10”x10”x10” Special by each unit, completed and accepted.

**E Payment**

The department will pay for measured quantities at the contract unit price under the following bid item:

ITEM NUMBER	DESCRIPTION	UNIT
SPV.0060.23	Tees 8”x6”x8” Special	EACH
SPV.0060.24	Tees 8”x8”x8” Special	EACH
SPV.0060.25	Tees 10”x6”x10” Special	EACH
SPV.0060.26	Tees 10”x10”x10” Special	EACH

Payment is full compensation for all work herein specified according to the “Standard Utilities and WIDNR SDWLP and CWFP Funding Specifications for WisDOT Let Projects, City of Beaver Dam”.

- 30. Bend 11.25-Degree 8-Inch Special, Item SPV.0060.27;  
Bend 11.25-Degree 10-Inch Special, Item SPV.0060.28;  
Bend 45-Degree 4-Inch Special, Item SPV.0060.29;  
Bend 45-Degree 6-Inch Special, Item SPV.0060.30;  
Bend 45-Degree 8-Inch Special, Item SPV.0060.31;  
Bend 45-Degree 10-Inch Special, Item SPV.0060.32;  
Bend 90-Degree 6-Inch Special, Item SPV.0060.33.**

**A Description**

This special provision describes Bend 11.25-Degree 8-Inch Special, Bend 11.25-Degree 10-Inch Special, Bend 45-Degree 4-Inch Special, Bend 45-Degree 6-Inch Special, Bend 45-Degree 8-Inch Special, Bend 45-Degree 10-Inch Special, Bend 90-Degree 6-Inch Special according to the “Standard Utilities and WIDNR SDWLP and CWFP Funding Specifications for WisDOT Let Projects, City of Beaver Dam”.

**B (Vacant)**

**C (Vacant)**

**D Measurement**

The department will measure Bend 11.25-Degree 8-Inch Special, Bend 11.25-Degree 10-Inch Special, Bend 45-Degree 4-Inch Special, Bend 45-Degree 6-Inch Special, Bend 45-Degree 8-Inch Special, Bend 45-Degree 10-Inch Special, Bend 90-Degree 6-Inch Special by each unit, completed and accepted.

**E Payment**

The department will pay for measured quantities at the contract unit price under the following bid item:

ITEM NUMBER	DESCRIPTION	UNIT
SPV.0060.27	Bend 11.25-Degree 8-Inch Special	EACH
SPV.0060.28	Bend 11.25-Degree 10-Inch Special	EACH
SPV.0060.29	Bend 45-Degree 4-Inch Special	EACH
SPV.0060.30	Bend 45-Degree 6-Inch Special	EACH
SPV.0060.31	Bend 45-Degree 8-Inch Special	EACH
SPV.0060.32	Bend 45-Degree 10-Inch Special	EACH
SPV.0060.33	Bend 90-Degree 6-Inch Special	EACH

Payment is full compensation for all work herein specified according to the “Standard Utilities and WIDNR SDWLP and CWFP Funding Specifications for WisDOT Let Projects, City of Beaver Dam”.

- 31. Reducer 8”x4” Special, Item SPV.0060.34;  
Reducer 8”x6” Special, Item SPV.0060.35;  
Reducer 10”x8” Special, Item SPV.0060.36.**

**A Description**

This special provision describes Reducer 8”x4” Special, Reducer 8”x6” Special, Reducer 10”x8” Special according to the “Standard Utilities and WIDNR SDWLP and CWFP Funding Specifications for WisDOT Let Projects, City of Beaver Dam”.

**B (Vacant)**

**C (Vacant)**

**D Measurement**

The department will measure Reducer 8”x4” Special, Reducer 8”x6” Special, Reducer 10”x8” Special by each unit, completed and accepted.

**E Payment**

The department will pay for measured quantities at the contract unit price under the following bid item:

ITEM NUMBER	DESCRIPTION	UNIT
SPV.0060.34	Reducer 8"x4" Special	EACH
SPV.0060.35	Reducer 8"x6" Special	EACH
SPV.0060.36	Reducer 10"x8" Special	EACH

Payment is full compensation for all work herein specified according to the "Standard Utilities and WIDNR SDWLP and CWFP Funding Specifications for WisDOT Let Projects, City of Beaver Dam".

**32. Connect to Existing Watermain, Item SPV.0060.37.**

**A Description**

This special provision describes Connect to Existing Watermain according to the "Standard Utilities and WIDNR SDWLP and CWFP Funding Specifications for WisDOT Let Projects, City of Beaver Dam".

**B (Vacant)**

**C (Vacant)**

**D Measurement**

The department will measure Connect to Existing Watermain by each unit, completed and accepted.

**E Payment**

The department will pay for measured quantities at the contract unit price under the following bid item:

ITEM NUMBER	DESCRIPTION	UNIT
SPV.0060.37	Connect to Existing Watermain	EACH

Payment is full compensation for all work herein specified according to the "Standard Utilities and WIDNR SDWLP and CWFP Funding Specifications for WisDOT Let Projects, City of Beaver Dam".

**33. Corporation, Curb Stop & Box (Set), Item SPV.0060.38.**

**A Description**

This special provision describes Corporation, Curb Stop & Box (Set) according to the "Standard Utilities and WIDNR SDWLP and CWFP Funding Specifications for WisDOT Let Projects, City of Beaver Dam".

**B (Vacant)**

**C (Vacant)**

**D Measurement**

The department will measure Corporation, Curb Stop & Box (Set) by each unit, completed and accepted.

**E Payment**

The department will pay for measured quantities at the contract unit price under the following bid item:

ITEM NUMBER	DESCRIPTION	UNIT
SPV.0060.38	Corporation, Curb Stop & Box (Set)	EACH

Payment is full compensation for all work herein specified according to the "Standard Utilities and WIDNR SDWLP and CWFP Funding Specifications for WisDOT Let Projects, City of Beaver Dam".



**34. Water Service Reconnection, Item SPV.0060.39.**

**A Description**

This special provision describes Water Service Reconnection according to the “Standard Utilities and WIDNR SDWLP and CFWP Funding Specifications for WisDOT Let Projects, City of Beaver Dam”.

**B (Vacant)**

**C (Vacant)**

**D Measurement**

The department will measure Water Service Reconnection by each unit, completed and accepted.

**E Payment**

The department will pay for measured quantities at the contract unit price under the following bid item:

ITEM NUMBER	DESCRIPTION	UNIT
SPV.0060.39	Water Service Reconnection	EACH

Payment is full compensation for all work herein specified according to the “Standard Utilities and WIDNR SDWLP and CFWP Funding Specifications for WisDOT Let Projects, City of Beaver Dam”, and for all labor, tools, equipment, and incidentals necessary to complete the work separately.

**35. Utility Line Opening (ULO), Item SPV.0060.40.**

**A Description**

Excavate and uncover utilities for the purposes of determining elevation and potential conflicts, as shown on the plans or as directed by the engineer, and as hereinafter provided.

**B (Vacant)**

**C Construction**

The excavation will be done in such a manner that the utility in question is not damaged and the safety of the workers is not compromised.

Perform the ULO as soon as possible and at least 10 days in advance of proposed utility construction to allow any conflicts to be resolved with minimal disruption. Where utilities are within 6 feet of each other at a potential conflict location, only one utility line opening will be called for. In these cases, a single utility line opening will be considered full payment to locate multiple utilities. Utility line openings will include a trench up to 5 feet long as measured at the trench bottom, and of any depth required to locate the intended utility.

All utility line openings will be approved and coordinated with the engineer. The utility engineers or their agents will be notified of this work a minimum of 3 days prior to the work so they may be present when the work is completed. The need for performing ULO's as shown on the plans will be verified since some of the utilities may have been relocated prior to the start of construction.

Replace pavement open to traffic within 24 hours of the excavation.

**D Measurement**

The department will measure Utility Line Opening (ULO) by the unit, acceptably completed. Where utilities are within 5' of each other at a potential conflict location, only one utility line opening will be measured.

**E Payment**

The department will pay for measured quantities at the contract price under the following bid item:

ITEM NUMBER	DESCRIPTION	UNIT
SPV.0060.40	Utility Line Opening (ULO)	EACH

Payment is full compensation for the excavation required to expose the utility line, backfilling with existing material removed from the excavation, compacting the backfill material, restoring the site, cleanup, and for all labor, tools, equipment, transportation, and incidentals to perform the work.

Existing pavement, concrete curb, gutter, and sidewalk removals necessary to facilitate utility line openings will not be considered part of or paid for under Utility Line Openings but will be considered separate and measured and paid for separately as removal items. Replacement pavement, concrete curb, gutter, and sidewalk items will also be considered separate from Utility Line Openings and will be measured and paid for separately.

**36. Inlet Cover Type Driveway Special, Item SPV.0060.41.**

Perform this work according to standard spec 611 and as shown in the plan details.

**37. Temporary Water Service Project 6995-00-14, Item SPV.0060.42;  
Abandon/Remove Sanitary Sewer Project 6995-00-14, Item SPV.0060.43;  
Abandon/Remove Water Main Project 6995-00-14, Item SPV.0060.44.**

**A Description**

This special provision describes Temporary Water Service, Abandon/Remove Sanitary Sewer, Abandon/Remove Water Main according to the “Standard Utilities and WIDNR SDWLP and CWFP Funding Specifications for WisDOT Let Projects, City of Beaver Dam”.

**B (Vacant)**

**C (Vacant)**

**D Measurement**

The department will measure Temporary Water Service, Abandon/Remove Sanitary Sewer, Abandon/Remove Water Main by each project, acceptably completed.

**E Payment**

The department will pay for measured quantities at the contract unit price under the following bid item:

ITEM NUMBER	DESCRIPTION	UNIT
SPV.0060.42	Temporary Water Service Project 6995-00-14	EACH
SPV.0060.43	Abandon/Remove Sanitary Sewer Project 6995-00-14	EACH
SPV.0060.44	Abandon/Remove Water Main Project 6995-00-14	EACH

Payment is full compensation for all work herein specified according to the “Standard Utilities and WIDNR SDWLP and CWFP Funding Specifications for WisDOT Let Projects, City of Beaver Dam”.

**38. Sanitary Sewer Pipe 8-Inch Special, Item SPV.0090.01;  
Sanitary Sewer Pipe 10-Inch Special, Item SPV.0090.02;  
Sanitary Sewer Pipe 24-Inch Special, Item SPV.0090.03;  
Sanitary Sewer Pipe 30-Inch Special, Item SPV.0090.04.**

**A Description**

This special provision describes Sanitary Sewer Pipe 8-Inch Special, Sanitary Sewer Pipe 10-Inch Special, Sanitary Sewer Pipe 24-Inch Special, Sanitary Sewer Pipe 30-Inch Special according to the “Standard Utilities and WIDNR SDWLP and CWFP Funding Specifications for WisDOT Let Projects, City of Beaver Dam”.

**B (Vacant)**

**C (Vacant)**

**D Measurement**

The department will measure Sanitary Sewer Pipe 8-Inch Special, Sanitary Sewer Pipe 10-Inch Special, Sanitary Sewer Pipe 24-Inch Special, Sanitary Sewer Pipe 30-Inch Special by the linear foot, as acceptably completed.

**E Payment**

The department will pay for measured quantities at the contract unit price under the following bid item:

ITEM NUMBER	DESCRIPTION	UNIT
SPV.0090.01	Sanitary Sewer Pipe 8-Inch Special	LF
SPV.0090.02	Sanitary Sewer Pipe 10-Inch Special	LF
SPV.0090.03	Sanitary Sewer Pipe 24-Inch Special	LF
SPV.0090.04	Sanitary Sewer Pipe 30-Inch Special	LF

Payment is full compensation for all work herein specified according to the “Standard Utilities and WIDNR SDWLP and CWFP Funding Specifications for WisDOT Let Projects, City of Beaver Dam”.

**39. Sanitary Lateral 6-Inch Item SPV.0090.05.**

**A Description**

This special provision describes Sanitary Lateral 6-Inch according to the “Standard Utilities and WIDNR SDWLP and CWFP Funding Specifications for WisDOT Let Projects, City of Beaver Dam”.

**B (Vacant)**

**C (Vacant)**

**D Measurement**

The department will measure Sanitary Lateral 6-Inch by the linear foot, as acceptably completed.

**E Payment**

The department will pay for measured quantities at the contract unit price under the following bid item:

ITEM NUMBER	DESCRIPTION	UNIT
SPV.0090.05	Sanitary Lateral 6-Inch	LF

Payment is full compensation for all work herein specified according to the “Standard Utilities and WIDNR SDWLP and CWFP Funding Specifications for WisDOT Let Projects, City of Beaver Dam”.

**40. Sanitary Sewer Televising, Item SPV.0090.06.**

**A Description**

This special provision describes Sanitary Sewer Televising according to the “Standard Utilities and WIDNR SDWLP and CWFP Funding Specifications for WisDOT Let Projects, City of Beaver Dam”.

**B (Vacant)**

**C (Vacant)**

**D Measurement**

The department will measure Sanitary Sewer Televising by the linear foot, as acceptably completed.

**E Payment**

The department will pay for measured quantities at the contract unit price under the following bid item:

ITEM NUMBER	DESCRIPTION	UNIT
SPV.0090.06	Sanitary Sewer Televising	LF

Payment is full compensation for all work herein specified according to the “Standard Utilities and WIDNR SDWLP and CWFP Funding Specifications for WisDOT Let Projects, City of Beaver Dam”.

- 41. PVC Water Main 4-Inch Special, Item SPV.0090.07;  
PVC Water Main 6-Inch Special, Item SPV.0090.08;  
PVC Water Main 8-Inch Special, Item SPV.0090.09;  
PVC Water Main 10-Inch Special, Item SPV.0090.10.**

**A Description**

This special provision describes PVC Water Main 4-Inch Special, PVC Water Main 6-Inch Special, PVC Water Main 8-Inch Special, PVC Water Main 10-Inch PVC Special according to the “Standard Utilities and WIDNR SDWLP and CWFP Funding Specifications for WisDOT Let Projects, City of Beaver Dam”.

**B (Vacant)**

**C (Vacant)**

**D Measurement**

The department will measure PVC Water Main 4-Inch Special, PVC Water Main 6-Inch Special, PVC Water Main 8-Inch Special, PVC Water Main 10-Inch PVC Special by the linear foot, as acceptably completed.

**E Payment**

The department will pay for measured quantities at the contract unit price under the following bid item:

ITEM NUMBER	DESCRIPTION	UNIT
SPV.0090.07	PVC Water Main 4-Inch Special	LF
SPV.0090.08	PVC Water Main 6-Inch Special	LF
SPV.0090.09	PVC Water Main 8-Inch Special	LF
SPV.0090.10	PVC Water Main 10-Inch Special	LF

Payment is full compensation for all work herein specified according to the “Standard Utilities and WIDNR SDWLP and CWFP Funding Specifications for WisDOT Let Projects, City of Beaver Dam”.

- 42. Water Service 1 to 2-Inch Special, Item SPV.0090.11.**

**A Description**

This special provision describes Water Service 1 to 2-Inch Special according to the “Standard Utilities and WIDNR SDWLP and CWFP Funding Specifications for WisDOT Let Projects, City of Beaver Dam”.

**B (Vacant)**

**C (Vacant)**

**D Measurement**

The department will measure Water Service 1 to 2-Inch Special by the linear foot, as acceptably completed.

**E Payment**

The department will pay for measured quantities at the contract unit price under the following bid item:

ITEM NUMBER	DESCRIPTION	UNIT
SPV.0090.11	Water Service 1 to 2-Inch Special	LF

Payment is full compensation for all work herein specified according to the “Standard Utilities and WIDNR SDWLP and CWFP Funding Specifications for WisDOT Let Projects, City of Beaver Dam”.

---

**ADDITIONAL SPECIAL PROVISION 1 (ASP 1)  
FOR TRANSPORTATION ALLIANCE FOR NEW SOLUTIONS (TrANS)  
PROGRAM EMPLOYMENT PLACEMENTS AND APPRENTICESHIPS**

---

The Safe, Accountable, Flexible, Efficient Transportation Equity Act: A Legacy for Users (SAFETEA-LU), Section 5204(e) – Surface Transportation Workforce Development Training and Education, provides for 100 percent Federal funding if the core program funds are used for training, education, or workforce development purposes, including “pipeline” activities. The core programs includes: Congestion Mitigation and Air Quality Improvement (CMAQ) Program, Highway Bridge Program (HBP), Interstate Maintenance (IM), National Highway System (NHS), and Surface Transportation Program (STP). These workforce development activities cover surface transportation workers, including OJT/SS programs for women and minorities as authorized in 23 U.S.C. §140(b).

*TrANS* is an employment program originally established in 1995 in Southeastern Wisconsin. Currently TrANS has expanded to include TrANS program locations to serve contractors in Southeast (Milwaukee and surrounding counties), Southcentral (Dane County and surrounding counties including Rock County), and most Northeastern Wisconsin counties from locations in Keshena, Rhinelander and surrounding far Northern areas. TrANS attempts to meet contractor’s needs in other geographic locations as possible. It is an industry driven plan of services to address the outreach, preparation, placement and retention of women, minorities and non-minorities as laborers and apprentices in the highway skilled trades. These candidate preparation and contractor coordination services are provided by community based organizations. For a list of the TrANS Coordinators contact the Disadvantaged Business Enterprise Office at (414) 438-4583 in Milwaukee or (608) 266-6961 in Madison. These services are provided to you at no cost.

### ***I. BASIC CONCEPTS***

Training reimbursements to employing contractors for new placements, rehires or promotions to apprentice of TrANS Program graduates will be made as follows:

- 1) **On-the-Job Training, Item ASP.1T0G, ASP 1 Graduate.** At the rate of \$5.00 per hour on federal aid projects when TrANS graduates are initially hired, or seasonally rehired, as unskilled laborers or the equivalent.

Eligibility and Duration: To the employing contractor, for up to 2000 hours from the point of initial hire as a TrANS program placement.

Contract Goal: To maintain the intent of the Equal Employment Opportunity program, it is a goal that   4   (*number*) TrANS Graduate(s) be utilized on this contract.

- 2) **On-the-Job Training, Item ASP.1T0A, ASP 1 Apprentice.** At the rate of \$5.00 per hour on federal aid projects at the point when an employee who came out of the TrANS Program is subsequently entered into an apprenticeship contract in an underutilized skilled trade (this will include the Skilled Laborer Apprenticeship when that standard is implemented).

Eligibility and Duration: To the employing contractor, for the length of time the TrANS graduate is in apprentice status.

Contract Goal: To maintain the intent of the Equal Employment Opportunity program, it is a goal that   2   (*number*) TrANS Apprentice(s) be utilized on this contract.

- 3) The maximum duration of reimbursement is two years as a TrANS graduate plus time in apprentice status.
- 4) If a TrANS program is not available in the contractor's area and another training program is utilized, payment of On-the-Job Training hours may be approved by the Wisconsin Department of Transportation (WisDOT) if the training program meets the established acceptance criteria. Only On-the-Job Training Hours accumulated after WisDOT approval will be reimbursed as specified under Items ASP.1T0G and ASP.1T0A. For more information, contact the Disadvantaged Business Enterprise Office at the phone numbers listed above.
- 5) WisDOT reserves the right to deny payments under items ASP.1T0G and ASP.1T0A if the contractor either fails to provide training or there is evidence of a lack of good faith in meeting the requirements of this training special provision.

## **II. RATIONALE AND SPECIAL NOTE**

The \$5.00 per hour now being paid for TrANS placements is intended to cover the duration of two years to allow for reaching entry-level laborer status. An additional incentive, the \$5.00 rate, would promote movement into the underutilized skilled trades' apprenticeships and applies until the individual completes their apprenticeship. These incentives benefit TrANS candidates by giving them a better opportunity to enter a skilled trade; benefits contractors who will be assisted in meeting their EEO profiles and goals; and benefits the public who will see the program reinforce larger public-private employment reform in Wisconsin. The pool of TrANS graduates was created for the purpose of addressing underutilization in the skilled trades, an objective that is further reinforced by a parallel retention pilot program, known as the Companywide Reporting. *Whether or not reimbursement is involved, the WisDOT reassures contractors who are in the Companywide Program that TrANS placements still contribute toward fulfilling the new hire goal of 50% women and minorities.* Based on data administered by United States Department of Labor (US DOL), the highway skilled trades remain underutilized for women statewide (less than 6.9%); and for minorities in all counties (% varies by county).

NOTE: *Unless using other advancement strategies, contractors are encouraged to use some or all of this monetary incentive to offset the cut in hourly wages an individual may incur when entering an apprenticeship if the full general laborer hourly rate has been previously paid. No special accounting measures are required.*

## **III. IMPLEMENTATION**

The implementation of ASP 1 is intended to cover only the amount of time it takes for underutilization to be resolved across the trades. This will be measured annually at the county and/or state levels using data administered by WisDWD in relation to goals set by the USDOL-

OFCCP. With appropriate state and federal approvals, we may also do some measurement at the company level.

It is the contractor's responsibility to note on their Certified Payrolls if their employee is a TrANS graduate or a TrANS apprentice. The District EEO Coordinators utilize the information on the Certified Payrolls to track the hours accumulated by TrANS Graduates and TrANS apprentices on WisDOT contracts. Payment under this ASP 1 is made based on the hours recorded off of the Certified Payrolls. Tracking may eventually include improved linkages with the WisDWD apprentice database, information from company and committee level sources.

TrANS is nondiscriminatory by regulation, and is a tool for optional use by contractors to address the underutilization of women and minorities as laborers and apprentices in our industry's skilled trades.

#### **IV. TRANS TRAINING**

As part of the contractor's equal employment opportunity affirmative action program, training shall be provided to employees enrolled in apprenticeship and on-the-job training programs as follows:

The contractor shall provide on-the-job training aimed at developing full journey workers in the type of trade or job classifications involved. In the event the contractor subcontracts a portion of the contract work, the contractor shall determine how many, if any, of the trainees are to be trained by the subcontractor provided, however, that the contractor shall retain the primary responsibility for meeting the training requirements imposed by this special provision. The contractor shall also insure that this training special provision is made applicable to such subcontract.

Training and upgrading of minorities and women toward journey workers status is a primary objective of this training special provision. Accordingly, the contractor shall make every effort to enroll minority trainees and women (e.g., by conducting systematic and direct recruitment through public and private sources likely to yield minority trainees and women trainees); to the extent such persons are available within a reasonable area of recruitment. The contractor will be given an opportunity and will be responsible for demonstrating the steps that they have taken in pursuance thereof, prior to determination as to whether the contractor is in compliance with this training special provision. This training commitment is not intended, and shall not be used, to discriminate against any applicant for training, whether a member of a minority group or not.

No employee shall be employed as a trainee in any classification in which they have successfully completed a training course leading to journey workers status or in which they have been employed as a journey worker. The contractor should satisfy this requirement by including appropriate questions in the employee application or by other suitable means. Regardless of the method used, the contractor's records should document the findings in each case.

#### **V. APPRENTICESHIP TRAINING**

The Federal Highway Administration's (FHWA) policy is to require full use of all available training and skill improvement opportunities to assure increased participation of minority groups, disadvantaged persons and women in all phases of the highway construction industry. The FHWA On-the-Job Training (OJT) Program requires the State transportation agencies (STAs) to establish apprenticeships and training programs targeted to move women, minorities, and disadvantaged individuals into journey-level positions to ensure that a competent workforce is available to meet highway construction hiring needs, and to address the historical under-representation of members of these groups in highway construction skilled crafts.

The OJT Supportive Services (OJT/SS) Program was established in Title 23 Code of Federal Regulations (CFR), Part 230) to supplement the OJT program and support STA training programs by providing services to highway construction contractors and assistance to highway construction apprentices and trainees. The primary objectives of OJT/SS are:

- (1) To increase the overall effectiveness of the State highway agencies' approved training programs.
- (2) To seek other ways to increase the training opportunities for women, minorities, and disadvantaged individuals.

The STAs are responsible for establishing procedures, subject to the availability of Surface Transportation and Bridge Funds under 23 U.S.C. §140(b) (Nondiscrimination), for the provision of supportive services with respect to training programs approved under 23 CFR, Part 230(a) (Equal Employment Opportunity on Federal and Federal-aid Construction Contracts – including Supportive Services).

The contractor and subcontractor shall maintain records to demonstrate compliance with these apprenticeship requirements. Reasonable exemptions and modifications to and from any or all of these requirements will be determined by the Wisconsin Department of Transportation-Civil Rights Office. A request for an exemption or modification, with justification, shall be made in writing, addressed to WisDOT Civil Rights Office, 4802 Sheboygan Avenue, P.O. Box 7965, Rm. 451, Madison, WI 53707.



## ADDITIONAL SPECIAL PROVISION 3

### DISADVANTAGED BUSINESS ENTERPRISE (DBE) PROGRAM IMPLEMENTATION

#### Authority

Wisconsin Department of Transportation (WisDOT) is a recipient of funds from the US Department of Transportation's Federal Highway Administration. The DBE program is a federal program applicable on all contracts administered by WisDOT that include federal-aid highway funds. The authority for the DBE program is the Transportation Bill as approved by Congress periodically. DBE program guidance and requirements are outlined in the Code of Federal Regulations at 49 CFR Part 26. This contract is subject to DBE provisions because it is financed with federal-aid-highway funds. Additionally, this contract is subject to the *State of Wisconsin Standard Specifications for Highway and Structure Construction* and all applicable contract documents.

#### Requirements

Pursuant to the federal DBE program regulation at 49 CFR Part 26, a contractor's failure to comply with any provision of the DBE program regulatory provisions will be considered a material breach of contract. This is nonnegotiable.

If a contractor fails to carry out the DBE program requirements and/or the Required Contract Provisions for Federal Aid Contracts (FHWA 1273) referenced in this document, sanctions will be assessed depending upon the facts, reasoning, severity, and remedial efforts of the contractor that may include: termination of contract, withholding payment, assessment of monetary sanctions, and/or suspension/debarment proceedings that could result in the disqualification of the contractor from bidding for a designated period of time.

- (1) At time of bid, ALL prime contractors must submit DBE Commitments on projects with DBE goals, The submittal of the DBE Commitments includes the DT1506 (Commitment to Subcontract to DBE), which can be attached as a PDF or entered digitally into the bid submittal and Attachments A OR quotes from all DBEs included on the Commitment. The prime contractor must submit a signed Attachment A via eSubmit (preferred) or the DBE Alert email box within 24-hours of the bid closing for all quotes submitted at the time of bid. If the assigned DBE contract goal is not met, Form DT1202 (Documentation of Good Faith Effort) and all supplemental DT1202 documentation is due within 24-hours of bid closing. Any change to DBE Commitments thereafter must follow modification of DBE subcontracting commitment (Section 9).
- (2) The Department requires this list of DBE subcontractors from all bidders at time of bid to ensure the lowest possible cost to taxpayers and fairness to other bidders and subcontractors. Bid shopping is prohibited.
- (3) The contractor must utilize the specific DBE firms listed in the approved DBE Commitment to perform the work and/or supply the materials for which the DBE firm is listed unless the contractor obtains written consent in advance from WisDOT. The contractor will not be entitled to payment for any work or materials on the approved DBE Commitment that is not performed or supplied by the listed DBE without WisDOT's written consent.

#### Description

The Wisconsin Department of Transportation is committed to the compliant administration of the DBE Program. The DBE provisions work in tandem with FHWA 1273 and WisDOT's *Standard Specifications for Highway and Structure Construction* and *Construction and Materials Manual*. The WisDOT Secretary is signatory to assurances of department-wide compliance.

The Department assigns the contract DBE goal as a percentage of work items that could be performed by certified DBE firms on the contract. The assigned DBE goal is expressed on the bid proposal as a percentage applicable to the total contract bid amount.

- (1) WisDOT identifies the assigned DBE goal in its contract advertisements and posts the contract DBE goal on the cover of the bidding proposal. The contractor can meet the assigned contract DBE goal by subcontracting work to a DBE firm or by procuring services or materials from a DBE firm.
- (2) Under the contract, the prime contractor should inform, advise, and develop participating DBE firms to be more knowledgeable contractors who are prepared to successfully complete their contractual agreement through the proactive provision of assistance in the following areas:
  - § Produce accurate and complete quotes
  - § Understand highway plans applicable to their work
  - § Understand specifications and contract requirements applicable to their work
  - § Understand contracting reporting requirements
- (3) The Department encourages contractors to assist DBE subcontractors more formally by participating in WisDOT's Business Development program as a mentor, coach, or resource. For comprehensive information on the Disadvantaged Business Enterprise Program, visit the Department's Civil Rights and Compliance Section website at: <http://wisconsindot.gov/Pages/doing-bus/civil-rights/dbe/default.aspx>

## 1. Definitions

Interpret these terms, used throughout this additional special provision, as follows:

- a. **Assigned DBE Contract Goal:** The percentage shown on the cover of the Highway Work Proposal that represents the feasible level of DBE participation for each contract. The goal is calculated using the Engineer's Estimate and DBE Interest Report. Goal assignment includes review of FHWA funds, analyzes bid items for subcontract opportunity and compatibility with DBE certified firm work codes. Additional factors considered include proximity, proportion, and regulations.
- b. **Bid Shopping:** In construction law, bid shopping is the practice of divulging a subcontractor's bid to another prospective contractor(s) before or after the award of a contract to secure a lower bid.
- c. **DBE:** Disadvantaged Business Enterprise – A for-profit small business concern where socially and economically disadvantaged individuals own at least a 51% interest and control management and daily business operations.
- d. **DBE Commitment:** The DBE Commitment is identified in the Commitment to Subcontract to DBE (Form DT1506) and is expressed as the amount of DBE participation the prime contractor has secured. The DT1506, a contract document completed by the bidder, is required to be considered a responsive bidder on an FHWA-funded contract that has an assigned DBE goal. The prime contractor will have the option to submit the DT1506 digitally, as an entry with the bid in Bid Express, or as an attachment to the bid.
- e. **DBE Utilization:** The actual participation of a DBE subcontractor on a project. WisDOT verifies DBE utilization through review of the DBE Commitment, payments to subcontractors, and contract documentation. The Prime Contractor receives DBE credit for payments made to the DBE firms performing the work listed on the approved DBE Commitment, and those submitted after approved commitment with Attachment A.
- f. **Good Faith Effort:** Legal term describing a diligent and honest effort taken by a reasonable person under the same set of facts or circumstances. For DBE subcontracting, the bidder must show that it took all necessary and reasonable steps to achieve the assigned DBE goal by the scope, intensity, and

appropriateness of effort that could reasonably be expected for a contractor to obtain sufficient DBE participation.

- g. **Manufacturer:** A firm that operates or maintains a factory or establishment that produces, on the premises, the materials, supplies, articles, or equipment required under the contract.
- h. **Reasonable Price:** Contractors are expected to assess reasonable price by analyzing the contract scope for DBE subcontract feasibility and comparing common line items in DBE and non-DBE subcontract quotes for the same work. Per federal regulation, reasonable price is not necessarily the lowest price.
- i. **Supplier:** A firm that owns, operates, or maintains a store, warehouse, or other establishment in which the materials, supplies, articles, or equipment required under the contract are bought, kept in stock, and regularly sold or leased to the public.
- j. **Tied quote:** Subcontractor quote that groups multiple bid/line items at a bundled/package price with a notation that the items within the quote will not be separated.

## 2. WisDOT DBE Program Compliance

### a. Documentation Submittal

The Commitment to Subcontract to DBE (Form DT1506 or digital submittal), Attachments A OR quotes from all DBEs included in the Commitment will be submitted at bid by ALL prime contractors. If the assigned DBE contract goal is not met, Documentation of Good Faith Effort (Form DT1202) must be submitted within 24-hours of bid closing. Supplemental DT1202 documentation and signed Attachments A from DBEs included in the DBE Commitment are also due within 24-hours of bid closing. Form DT1202, supporting GFE documentation, and signed Attachments A, not submitted at the time of bid, must be submitted through eSubmit (preferred) or to the DBE Alert email box.

\*\*Bidders have the option of submitting the DBE Commitment at the time of bid via direct entry through Bid Express OR with attachment of Form DT1506 (Commitment to Subcontract to DBE). The DBE Commitment entered with bid is the digital form of the DT1506. Separate submission of Form DT1506 is not required if the DBE Commitment is entered in Bid Express. Form DT1202, if applicable, is no longer required to be submitted at time of bid; submit DT1202 within the 24-hour supplemental time frame following bid closing.

Naming conventions: Follow eSubmit [instructions](#), OR when emailing files, use the following language to identify your submission- "Project #, Proposal #, Let date, Business Name, GFE" and "Project #, Proposal #, Let date, Business Name, Attachment A" Email: [DBE\\_Alert@dot.wi.gov](mailto:DBE_Alert@dot.wi.gov)

The DBE Office will not certify Good Faith Effort and the Bureau of Project Development will consider the bid nonresponsive if the contractor fails to furnish the DBE Commitment (digitally entered into the bid OR Form DT1506 as an attachment), Attachments A, and Form DT1202 if applicable, as required. See sample forms in the Appendix.

### b. Verification of DBE Commitment

The documentation related to DBE subcontract commitment submitted prior to contract award is evaluated as follows:

#### (1) DBE Goal Met

If the bidder indicates that the contract DBE goal is met, the Department will evaluate the DBE Commitment submitted with bid OR Form DT1506, and Attachments A to verify the actual DBE

percentage calculation. If the DBE Commitment is verified, the contract is eligible for award with respect to the DBE Commitment.

(2) **DBE Goal Not Met**

- a) If the bidder indicates a bid percentage on the DBE Commitment that does not meet the assigned DBE contract goal, the bidder must request alternative evaluation of good faith effort through submission of Form DT1202 (Documentation of Good Faith Effort) within 24-hours of bid including narrative description. Supplementary documentation of good faith effort that supports the DT1202 submission is also due within 24-hours of bid submission and prior to bid posting. The Department will review the bidder's DBE Commitment and evaluate the bidder's good faith efforts submission.
- b) Following evaluation of the bidder's Good Faith Effort documentation the bidder will be notified that the Department intends to:
  1. *Approve* the request (adequate documentation of GFE has been submitted)- no conditions placed on the contract with respect to the DBE Commitment;
  2. *Deny* the request (inadequate documentation of GFE has been submitted)- the contract is viewed as non-responsive per Wisconsin Standard Specifications for Highway and Structure Construction and will not be executed.
- c) If the Department denies the bidder's request, the contract is ineligible for award. The Department will provide a written explanation for denying the request to the bidder. The bidder may appeal the Department's denial (see Section 4).

Supplemental good faith effort documentation must be submitted through eSubmit (preferred) OR to the DBE Office by email at: [DBE\\_Alert@dot.wi.gov](mailto:DBE_Alert@dot.wi.gov). Email naming convention: "Project #, Proposal #, Let date, Business Name, GFE"

### 3. Department's Criteria for Good Faith Effort Documentation

The Federal-aid Construction Contract Provision, referenced as FHWA-1273, explicitly states that the prime contractor shall be responsible for all work performed on the contract by piecework, station work, or subcontract. The contractor shall take all necessary and reasonable steps to ensure nondiscrimination in the administration of the contract including assurances of equal employment opportunity laws, DBE regulations, and affirmative action. Compliance encompasses responsible and responsive action, documentation, and good faith effort.

Contractually, all contractors, subcontractors, and service providers on the contract are bound by FHWA 1273 and DBE program provisions. **Prime contractors should encourage subcontractors to utilize DBE firms whenever possible to contribute to the assigned DBE contract goal.**

Bidders are required to document good faith effort. Per 49 CFR Part 26.53, good faith effort is demonstrated in one of two ways. The bidder:

- (1) Documents that it has obtained enough DBE participation to meet the goal; OR
- (2) Documents that it made adequate good faith efforts to meet the goal, even though it did not succeed

*Appendix A* of 49 CFR Part 26 provides guidance concerning good faith efforts. WisDOT evaluates good faith effort on a contract basis just as each contract award is evaluated individually.

The efforts employed by the bidder should be those that WisDOT can reasonably expect a bidder to take to actively and aggressively obtain DBE participation sufficient to meet the DBE contract goal. The Department will only approve demonstration of good faith effort if the bidder documents the quality, quantity, and intensity of the variety of activities undertaken that are commensurate with expected efforts to meet the stated goal.

The Department, in conjunction with industry stakeholders, has developed the following guidance for contractor good faith effort activity. The guidance and the attached appendices provide a framework for the actions required by all parties in the processing and evaluation of bidder's total efforts to achieve the project specific DBE goal prior to the bid letting date.

**a. Solicitation Guidance for Prime Contractors:**

- (1) Document all efforts and decisions made toward achieving the DBE goal on the contract. The bidder should use WisDOT-approved DBE outreach tools, including the UCP DBE Directory and the Bid Express Small Business Network to foster DBE participation on all applicable contracts.
- (2) As needed, request assistance with DBE outreach and follow-up by contacting the Department's DBE Support Services Office by phone or email request at least 14 days prior to the bid letting date. Phone numbers are (414) 438-4584 and/or (608) 267-3849; Fax: (414) 438-5392; E-mail: [DBE\\_Alert@dot.wi.gov](mailto:DBE_Alert@dot.wi.gov)
- (3) Participate in and document a substantive conversation with at least one DBE firm per Let, to discuss questions, concerns, and any other contract related matters that may be applicable to the DBE firm. Guidelines for this conversation are provided in Appendix A of ASP-3.
- (4) Request quotes by identifying potential items to subcontract and solicit. In their initial contacts, contractors are strongly encouraged to include a single page, detailed list of items for which they are accepting quotes, by project, within a letting. See attached sample entitled "Sample Contractor Solicitation Letter" in Appendix B. Prime contractors should also indicate a willingness to accept quotes in areas they are planning to perform themselves, as required by federal rules. In some cases, it might be appropriate to use DBE firms to do work in a prime contractor's area of specialization.
  - i. Solicit quotes from certified DBE firms who match possible items to subcontract using all reasonable and available means. Additionally, forward copies of solicitations highlighting the work areas for which quotes are being sought to [DBE\\_Alert@dot.wi.gov](mailto:DBE_Alert@dot.wi.gov)
  - ii. Acceptable outreach tools include SBN (Small Business Network, see Appendix C):
    - <https://www.bidx.com/wi/main>, postal mail, email, fax, and phone.
    - a. Contractors must ask DBE firms for a response in their solicitations. See *Sample Contractor Solicitation Letter*, Appendix B. This letter may be included as an attachment to the sub-quote request.
    - b. Solicit quotes at least 10 calendar days prior to the letting date to allow DBE firms sufficient time to respond. Prime contractors should contact DBE firms early, asking if they need help organizing their quote, assistance confirming equipment needs, or other assistance supporting their submission of a competitive quote for their services.
    - c. A follow up solicitation should take place within 5 calendar days of the letting date. Email and/or SBN are the preferred method for the solicitation.
  - iii. Upon request, provide interested DBE firms with adequate information about plans, specifications, and the requirements of the contract by letter, information session, email, phone call, and/or referral.
  - iv. When potential exists, the contractor should advise interested DBE firms on how to obtain bonding, line of credit, or insurance if requested.
  - v. Document DBE firm's interest in quoting by taking appropriate steps to follow up initial solicitation with:
    - a. Email to all prospective DBE firms in relevant work areas
    - b. Phone call log to DBE firms who express interest via written response or call
    - c. Fax/letter confirmation
    - d. Signed copy of record of subcontractor outreach effort

**b. Guidance for Evaluating DBE quotes**

- (1) Quote evaluation practices required to evaluate DBE quotes:
  - i. Reasonable Price: Contractors are expected to assess reasonable price by analyzing the contract scope for DBE subcontract feasibility and comparing common line items in DBE and

non-DBE subcontract quotes for the same work. Per federal regulation, reasonable price is not necessarily the lowest price. See 49 CFR Part 26, Appendix A. IV.D(2).

- (2) Documentation submitted by the prime of the following evaluation is required to evaluate DBE quotes by contractors:
  - i. Evaluation of DBE firm's ability to perform "possible items to subcontract" using legitimate reasons, including but not limited to, **a discussion** between the prime and DBE firm regarding its capabilities prior to the bid letting. If lack of capacity is the reason for not utilizing the DBE firm's quote, the prime is required to contact the DBE by phone and email regarding their ability to perform the work indicated in the UCP directory listed as their work area by NAICS code. Only the work area indicated by the NAICS code(s) listed in the UCP directory can be counted toward DBE credit. Documentation of the conversation is required.
    - a In striving to meet an assigned DBE contract goal, contractors are expected to use DBE quotes that are responsive and reasonable. This includes DBE quotes that are not the low quote.
    - b Additional evaluation - Evaluation of DBE quotes with tied bid items. Typically, this type of quoting represents a cost saving but is not clearly stated as a discount. Tied quotes are usually presented as an 'all or none' quote. When non-DBE subcontractors submit tied bid items in their quotes, the DBE firm's quote may not appear competitive. In such a case, the following steps are taken in comparing the relevant quotes. These are qualitative examples:
      - i Compare bid items common to both quotes, noting the reasonableness in the price comparison.
      - ii Review quotes from other firms for the bid items not quoted by the DBE firm to see if combining both can provide the same competitive advantage that the tied bid items offered.

See Appendix D – *Good Faith Effort Evaluation Measures* and Appendix E - *Good Faith Effort Best Practices*.

- c. **Requesting Good Faith Effort Evaluation** At the time of bid- if the DBE goal is not met in full, the prime contractor must indicate they will file form DT1202- Documentation of Good Faith Effort within 24-hours of bid submission. Supplementary documentation of good faith effort that supports the DT1202 submission is also due within 24-hours of bid submission and prior to bid posting. Supporting documentation for the DT1202 is to include the following:
  - (1) Solicitation Documentation: The names, addresses, email addresses, and telephone numbers of DBE firms contacted along with the dates of both initial and follow-up contact; electronic copies of all written solicitations to DBE firms. A printed copy of SBN solicitation is acceptable.
  - (2) Selected Work Items Documentation: Identify economically feasible work units to be performed by DBEs to include activities such as: list of work items to be performed; breaking up of large work items into smaller tasks or quantities; flexible time frames for performance and delivery schedules.
  - (3) Documentation of Project Information provided to interested DBEs: A description of information provided to the DBE firms regarding the plans, specifications, and estimated quantities for portions of the work to be performed by that DBE firm.
  - (4) Documentation of Negotiation with Interested DBEs: Provide sufficient evidence to demonstrate that good faith negotiations took place. Merely sending out solicitations requesting bids from DBEs does not constitute sufficient good faith efforts.
  - (5) Documentation of Sound Reasoning for Rejecting DBEs and copies of each quote received from a DBE firm and, if rejected, copies of quotes from non-DBEs for same items.
  - (6) Documentation of Assistance to Interested DBEs- Bonding, Credit, Insurance, Equipment, Supplies/Materials
  - (7) Documentation of outreach to Minority, Women, and Community Organizations and other DBE Business Development Support: Contact organizations and agencies for assistance in contacting, recruiting, and

providing support to DBE subcontractors, suppliers, manufacturers, and truckers at least 14 days before bid opening. Participate in or host activities such as networking events, mentor-protégé programs, small business development workshops, and others consistent with DBE support.

Naming conventions: eSubmit (preferred) follow instructions OR when emailing files, use the following language to identify your submission- "Project #, Proposal #, Let date, Business Name, GFE" Email: [DBE\\_Alert@dot.wi.gov](mailto:DBE_Alert@dot.wi.gov)

If the Good Faith Effort documentation is deemed adequate, the request will be approved and the DBE office will promptly notify the Prime Contractor and Bureau of Project Development.

If the DBE Office denies the request, the Prime Contractor will receive written correspondence outlining the reasons. The Department encourages the Prime Contractor to communicate with DBE staff to clarify any questions related to meeting goals and/or contractor demonstration of good faith efforts.

If the contract is awarded, the Prime Contractor must obtain written consent from the DBE Office to change or replace any DBE firm listed on the approved DBE Commitment. No contractor, prime or subsequent tier, shall be paid for completing work assigned to a DBE subcontractor on an approved DBE Commitment unless WisDOT has granted permission for the reduction, replacement, or termination of the assigned DBE in writing. If a prime contractor or a subcontractor on any tier uses its own forces to perform work assigned to a DBE on an approved DBE Commitment, **they will not be paid for the work**. Any changes to DBE Commitment after the approval of the DBE Commitment must be reviewed and approved by the DBE Office prior to the change (see Section 9).

#### **4. Bidder's Documentation of Good Faith Effort Evaluation Request Appeal Process**

A bidder can appeal the Department's decision to deny the bidder's demonstration of Good Faith Effort through Administrative Reconsideration. The bidder must provide a written justification refuting the specific reasons for denial as stated in the Department's denial notice. The bidder may meet in person with the Department if so requested. Failure to appeal within 5 business days after receiving the Department's written notice denying the request constitutes a forfeiture of the bidder's right of appeal. Receipt of appeal is confirmed by email date stamp or certified mail signed by WisDOT staff. A contract will not be executed without documentation that the DBE provisions have been fulfilled.

The Department will appoint a representative who did not participate in the original good faith effort determination, to assess the bidder's appeal. The Department will issue a written decision within 5 business days after the bidder presents all written and oral information. In that written decision, the Department will explain the basis for finding that the bidder did or did not demonstrate an adequate good faith effort to meet the contract DBE goal. The Department's decision is final.

#### **5. Determining DBE Eligibility**

##### **Directory of DBE firms**

- a. The only resource for DBE firms certified in the State of Wisconsin is the Wisconsin Unified Certification Program (UCP) DBE Directory. WisDOT maintains a current list of certified DBE firms at: <http://wisconsindot.gov/Documents/doing-bus/civil-rights/dbe/dbe-ucp-directory.xlsx>
- b. The DBE Program office is available to assist with contracting DBE firms:(608) 267-3849.



- c. DBE firms are certified based on various factors including the federal standards from the Small Business Administration that assigns a North American Industrial Classification (NAICS) Codes. DBE firms are only eligible for credit when performing work in their assigned NAICS code(s). If a DBE subcontractor performs work that is not with its assigned NAICS code, the prime contractor should contact the DBE Office to inquire about compatibility with the Business Development Program.

## 6. Counting DBE Participation

### Assessing DBE Work

The Department will only count the DBE usage towards the contract DBE goal if the DBE firm is certified as a DBE by one of the UCP agencies. The Department only counts the value of the work a DBE actually performs towards the DBE goal. The Department assesses the DBE work as follows:

- a. The Department counts work performed by the DBE firm's own resources. The Department includes the cost of materials and supplies the DBE firm obtains for the work. The Department also includes the cost of equipment the DBE firm leases for the work. The Department will not include the cost of materials, supplies, or equipment the DBE firm purchases or leases from the prime contractor or its affiliate, with the exception of non-project specific leases the DBE has in place before the work is advertised.
- b. The Department counts fees and commissions the DBE subcontractor charges for providing bona fide professional, technical, consultant, or managerial services. The Department also counts fees and commissions the DBE charges for providing bonds or insurance. The Department will only count costs the program engineer deems reasonable based on experience or prevailing market rates.
- c. If a DBE firm subcontracts work, the Department counts the value of the work subcontracted to a DBE subcontractor.
- d. The contractor will maintain records and may be required to furnish periodic reports documenting its performance under this item.
- e. It is the Prime Contractor's responsibility to determine whether the work that is committed and/or contracted to a DBE firm can be counted for DBE credit by referencing the work type and NAICS code listed for the DBE firm on the Wisconsin UCP DBE Directory.
- f. It is the Prime Contractor's responsibility to assess the DBE firm's ability to perform the work for which it is committing/contracting the DBE to do. Note that the Department encourages the Prime Contractor to assist and develop DBE firms to become fully knowledgeable contractors to successfully perform on its contracts.
- g. The Prime Contractor will inform the DBE office via email of all DBE subcontractors added to the project following execution of the contract. The Prime Contractor may omit submission of another form DT1506, but must submit signed Attachment A forms for additional DBE firms.
- h. See Section 7 for DBE credit evaluation for Trucking and Section 8 for DBE credit evaluation for Manufacturers, Suppliers, and Brokers

Naming conventions: When emailing files, please use the following language to identify your submission-  
"Project #, Proposal #, Let date, Business Name, Attachment A"      Email: [DBE\\_Alert@dot.wi.gov](mailto:DBE_Alert@dot.wi.gov)



\*Note: A sublet request is required for DBE work, regardless of subcontract tier, and also for reporting materials or supplies furnished by a DBE.

- Sublet Requests via form DT1925 or WS1925 are required for 1st Tier DBEs
- For all 2nd Tier and below notification of DBE sublet is indicated by the contractor entering them in CRCS

## 7. Credit Evaluation for Trucking

All bidders are expected to adhere to the Department's current trucking policy posted on the HCCI website at: <http://wisconsin.gov/Documents/doing-bus/civil-rights/dbe/trucking-utilization-policy.pdf>

The prime contractor is responsible for ensuring that all subcontractors including trucking firms, receive Form FHWA 1273: <https://www.fhwa.dot.gov/programadmin/contracts/1273/1273.pdf>

See Section 8 for Broker credit.

## 8. Credit Evaluation for Manufacturers, Suppliers, Brokers

The Department will calculate the amount of DBE credit awarded to a prime using a DBE firm for the provisions of materials and supplies on a contract-by-contract basis. The Department will count the material and supplies that a DBE firm provides under the contract for DBE credit based on whether the DBE firm is a manufacturer, supplier, or broker. Generally, DBE credit is determined through evaluation of the DBE owner's role, responsibility, and contribution to the transaction. Maximum DBE credit is awarded when the DBE firm manufactures materials or supplies. DBE credit decreases when the DBE firm solely supplies materials, and minimal credit is allotted when the DBE firm's role is administrative or transactional. It is the bidder's responsibility to confirm that the DBE firm is considered a supplier or a manufacturer before listing them on Commitment to Subcontract to DBE form DT1506 or DBE Commitment submitted with the bid.

### a. Manufacturers

- (1) A manufacturer is a firm that operates or maintains a factory or establishment that produces, on the premises, the materials, supplies, articles, or equipment required under the contract and of the general character described by the specifications.
- (2) If the materials or supplies are obtained from a DBE manufacturer, **100%** percent of the cost of the materials or supplies counts toward DBE goals.

### b. Regular Dealers of Material and/or Supplies

- (1) Supplies purchased in bulk from DBE firms at the beginning of the season may be credited to current contracts if submitted with appropriate documentation to the DBE office.
- (2) A regular dealer is a firm that owns, operates, or maintains a store, warehouse, or other establishment in which the materials, supplies, articles or equipment of the general character described by the specifications and required under the contract are bought, kept in stock, and regularly sold or leased to the public in the usual course of business.
- (3) If the materials or supplies are purchased from a DBE regular dealer, count **60%** percent of the cost of the materials or supplies toward DBE goals.
- (4) At a minimum, a regular dealer must meet the following criteria to be counted for DBE credit:
  - i. The DBE firm must be an established, regular business that engages, as its principal business and under its own name, in the purchase and sale or lease of the products in question.
  - ii. The DBE firm must both own and operate distribution equipment for the product--bulk items such as petroleum products, steel, cement, gravel, stone, or asphalt. If some of the distribution equipment is leased, the lease agreement must accompany the DBE Commitment form for evaluation of the dealer's control before the DBE office approves the DBE credit.

- (5) When DBE suppliers are contracted, additional documentation must accompany the DBE Commitment and Attachment A forms. An invoice or bill-of-sale that includes names of the bidder and the DBE supplier, along with documentation of the calculations used as the basis for the purchase agreement, subcontract, or invoice. WisDOT recognizes that the amount on the Attachment A form may be more or less than the amount on the invoice per b.(1) above.
  - i. The bidder should respond to the following questions and include with submission of form DT1506 or the DBE Commitment entered with bid:
    - a. What is the product or material?
    - b. Is this item in the prime's inventory or was the item purchased when contract was awarded?
    - c. Which contract line items were referenced to develop this quote?
    - d. What is the amount of material or product used on the project?

**c. Brokers, Transaction Expeditors, Packagers, Manufacturers' Representatives**

- (1) No portion of the cost of the materials, supplies, services themselves will count for DBE credit. However, WisDOT will evaluate the fees or commissions charged when a prime purchases materials, supplies, or services from a DBE certified firm which is neither a manufacturer nor a regular dealer, namely: brokers, packagers, manufacturers' representatives, or other persons who arrange or expedite transactions.
- (2) Brokerage fees are calculated as **10%** of the purchase amount.
- (3) WisDOT may count the amount of fees or commissions charged for assistance in the procurement of the materials and supplies, fees, or transportation charges for the delivery of materials or supplies required on a job site.
- (4) Evaluation of DBE credit includes review of the contract need for the item/service, the sub-contract or invoice for the item/service, and a comparison of the fees customarily allowed for similar services to determine whether they are reasonable.

## **9. DBE Commitment Modification Policy (Formerly "DBE Replacement Policy")**

**a. Issuing a Contract Change Order**

Any changes or modifications to the contract once executed are considered contract modifications and as such require a change order. In addition, the DBE office must provide consent for reduction, termination, or replacement of subcontractors approved on the DBE Commitment *in advance* of the modification for the prime contractor to receive payment for work or supplies. Additions to the DBE Commitment do not require advance notification of the DBE office. (see below e. DBE Utilization beyond the approved DBE Commitment)

**b. Contractor Considerations**

- (1) A prime contractor cannot modify the DBE Commitment through reduction in participation, termination, or replacement of a DBE subcontractor listed on the approved DBE Commitment without prior written consent from the DBE Office. This includes, but is not limited to, instances in which a prime contractor seeks to perform work originally designated for a DBE subcontractor with its own forces or those of an affiliate, a non-DBE firm, or with another DBE firm.
- (2) If a prime contractor reduces participation, replaces, or terminates a DBE subcontractor who has been approved for DBE credit toward its contract, the prime is required to provide documentation supporting its inability to fulfill the contractual commitment made to the Department regarding the DBE utilization.
- (3) The Prime Contractor is required to demonstrate efforts to find another DBE subcontractor to perform at least the same amount of work under the contract as the DBE subcontractor that was terminated, to the extent needed to meet the assigned DBE contract goal. When additional opportunity is available by contract modifications, the Prime Contractor must utilize DBE subcontractors that were committed to equal work items, in the original contract.

- (4) In circumstances when a DBE subcontractor fails to complete its work on the contract for any reason, or is terminated from a contract, the Prime Contractor must undertake efforts to maintain its commitment to the assigned DBE goal.
- (5) The DBE subcontractor should communicate with the Prime Contractor regarding its schedule and capacity in the context of the contract. If the DBE firm anticipates that it cannot fulfill its subcontract, they will advise the Prime Contractor and suggest a DBE subcontractor that may replace their services and provide written consent to be released from its subcontract.
  - i. Before the Prime Contractor can request modification to the approved DBE Commitment, the Prime Contractor must:
    - a. Make every effort to fulfill the DBE Commitment by working with the listed DBE subcontractor to ensure that the firm is fully knowledgeable of the Prime Contractor's expectations for successful performance on the contract. Document these efforts in writing.
    - b. If those efforts fail, provide written notice to the DBE subcontractor of the Prime Contractor's intent to request to modify the Commitment through reduction in participation, termination, and/or replacement of the subcontractor including the reason(s) for pursuing this action.
    - c. Copy the DBE Office on all correspondence related to changing a DBE subcontractor who has been approved for DBE credit on a contract, including preparation and coordination efforts.
    - d. Clearly state the amount of time the DBE firm has to remedy and/or respond to the notice of intent to replace/terminate. The DBE must be allowed five days from the date notice was received as indicated by email time stamp or signed certified mail, to respond, in writing. EXCEPTION: The Prime Contractor must provide a verifiable reason for a response period shorter than five days. For example, a WisDOT project engineer or project manager confirms that WisDOT has eliminated an item the DBE subcontractor was contracted for.
    - e. The DBE subcontractor must acknowledge the contract modification with written response to the Prime Contractor and the DBE Office. If objecting to the subcontract modification, the DBE subcontractor must outline the basis for objection to the proposed modification, providing sound reasoning for WisDOT to reject the prime's request.

### **c. Request to Modify DBE Subcontracting Commitment**

The written request referenced above may be delivered by email or fax. The request must contain the following:

1. Project ID number
2. WisDOT Contract Project Engineer's name and contact information
3. DBE subcontractor name and work type and/or NAICS code
4. Contract's progress schedule
5. Reason(s) for requesting that the DBE subcontractor be replaced or terminated
6. Attach/include all communication with the DBE subcontractor to deploy/address/resolve work completion

Naming conventions: When emailing files, please use the following language to identify your submission- "Project #, Proposal #, Let date, Business Name, MODIFICATION" Email: [DBE\\_Alert@dot.wi.gov](mailto:DBE_Alert@dot.wi.gov) + Project Engineer

WisDOT will review the request and any supporting documentation submitted to evaluate if the circumstance and the reasons constitute good cause for replacing or terminating the approved DBE subcontractor.

*Good Causes to Replace a DBE subcontractor according to the federal DBE program guidelines {49 CFR part 26.53}*

- The listed DBE subcontractor fails or refuses to execute a written contract

- The listed DBE subcontractor fails or refuses to perform the work of its subcontract in a way consistent with normal industry standards. Provided, however, that good cause does not exist if the failure or refusal of the DBE subcontractor to perform its work on the subcontract results from the bad faith or discriminatory action of the prime contractor
- The listed DBE subcontractor fails or refuses to meet the prime contractor's reasonable, nondiscriminatory bond requirements
- The listed DBE subcontractor becomes bankrupt, insolvent, or exhibits credit unworthiness
- The listed DBE subcontractor is ineligible to work on public works projects because of suspension and debarment proceedings pursuant 2 CFR Parts 180, 215, and 1,200 or applicable state law
- The prime has determined that the listed DBE subcontractor is not a responsible contractor
- The listed DBE subcontractor voluntarily withdraws from the project and provides written notice of its withdrawal
- The listed DBE subcontractor is ineligible to receive DBE credit for the type of work required
- A DBE firm owner dies or becomes disabled with the result that the listed DBE subcontractor is unable to complete its work on the contract

#### **d. Evaluation and Response to the Request**

WisDOT's timely response to the Prime Contractor's request for modification of the approved DBE Commitment will be provided to the prime and the WisDOT project engineer via email.

If WisDOT determines that the Prime Contractor's basis for reduction in participation, replacement, or termination of the DBE subcontractor is not consistent with the good cause guidelines, the DBE office will provide a response via email within 48-hours of receipt of request from the Prime Contractor as indicated by email time stamp. The communication will include: the requirement to utilize the committed DBE, actions to support the completion of the contractual commitment, a list of available WisDOT support services, and administrative remedies, including withholding payment to the prime, that may be invoked for failure to comply with federal DBE guidelines for DBE replacement.

The WisDOT contact for all actions related to modification of the approved DBE Commitment is the DBE Program Engineer who can be reached at [DBE\\_Alert@dot.wi.gov](mailto:DBE_Alert@dot.wi.gov) or (414) 335-0413.

#### **e. DBE Utilization beyond the approved DBE Commitment**

When the prime or a subcontractor increases the scope of work for an approved DBE subcontractor or adds a DBE subcontractor who was not on the approved form DT1506 or DBE Commitment submitted with bid at any time after contract execution, this is referred to as voluntary DBE contract goal achievement. The contractor must follow these steps to ensure that the participation is accurately credited toward the DBE goal:

- (1) Forward a complete, signed Attachment A form to the DBE Office. A complete Attachment A includes DBE subcontractor contact information, signatures, subcontract value, and description of the work areas to be performed by the DBE. The DBE Office will verify the DBE participation and revise the DBE Commitment based on the email/discussion and the new Attachment A.
- (2) When adding to an existing DBE Commitment, submit a new Attachment A to the DBE Alert mailbox
- (3) OR Submit a final Attachment A to DBE Alert during the Finals Process when Compliance receives notice of "Substantially Complete"  
 Naming conventions: When emailing files, please use the following language to identify your submission- "Project #, Proposal #, Let date, Business Name, New Attachment A" Email: [DBE\\_Alert@dot.wi.gov](mailto:DBE_Alert@dot.wi.gov)

**Special note on trucking**

- DBE truckers added to the sublets in CRCS *will* be approved without DBE credit (You will see a “N” in CRCS instead of “Y”)
- Prime Contractors may enter a “place holder” e.g. \$1000.00, for DBE Trucking in CRCS if the full amount of trucking is unknown for sublet purposes only
- The hiring contractor may obtain the Attachment A with DBE signature included but the **Prime Contractor** must sign the Attachment A before submitting

**10. Commercially Useful Function**

- a. Commercially Useful Function (CUF) is evaluated after the contract has been executed, while the DBE certified firm is performing contracted work items.
- b. The Department uses Form DT1011, DBE Commercially Useful Function Review and Certification to evaluate if the DBE is performing a commercially useful function. WisDOT counts expenditures of a DBE toward the DBE goal only if the DBE is performing a commercially useful function on that contract.
- c. A DBE firm is performing a commercially useful function if the following conditions are met:
  - (1) For contract work, the DBE is responsible for executing a distinct portion of the work and is carrying out its responsibilities by actually performing, managing, and supervising that work.
  - (2) For materials and supplies, the DBE is responsible for negotiating price, determining quality and quantity, ordering, and paying for those materials and supplies.

**11. Credit Evaluation for DBE Primes**

WisDOT calculates DBE credit based on the amount and type of work performed by DBE certified firms for work submitted with required documentation. If the prime contractor is a DBE certified firm, the Department will only count the work that the DBE prime performs with its own forces for DBE neutral credit. The Department will also calculate DBE credit for work performed by any other DBE certified subcontractor, DBE certified supplier, and DBE certified manufacturer on the contract in each firm’s approved NAICS code/work areas that are submitted with required documentation. Crediting for manufacturers and suppliers is calculated consistent with Section 8 of this document and 49 CFR Part 26.

**12. Joint Venture**

If a DBE performs as a participant in a joint venture, the Department will only count the portion of the total dollar value of the contract equal to the portion of the work that the DBE performs with its own forces, for DBE credit.

**13. Mentor-Protégé**

- a. If a DBE performs as a participant in a mentor-protégé agreement, the Department will credit the portion of the work performed by the DBE protégé firm.
- b. DBE credit is evaluated and confirmed by the DBE Office for any contracts on which the mentor-protégé team identifies itself to the DBE Office as a current participant of the Mentor-Protégé Program.
- c. Refer to WisDOT’s Mentor-Protégé guidelines for guidance on the number of contracts and amount of DBE credit allowed on WisDOT projects.

## 14. Use of Joint Checks

The use of joint checks is allowable if it is a commonly recognized business practice in the material industry. A joint check is defined as a two-party check between a DBE subcontractor, a prime contractor, and the regular dealer or materials supplier who is neither the prime nor an affiliate of the prime. Typically, the prime contractor issues one check as payor to the DBE subcontractor and to the supplier jointly (to guarantee payment to the supplier) as payment for the material/supplies used by the DBE firm in cases where the DBE subcontractor and materials have been approved for DBE credit. The DBE subcontractor gains the opportunity to establish a direct contracting relationship with the supplier to potentially facilitate a business rapport that results in a line of credit or increased partnering opportunities.

The cost of material and supplies purchased by the DBE firm is part of the value of work performed by the DBE to be counted toward the goal. To receive credit, the DBE firm must be responsible for negotiating price, determining quality and quantity, ordering the materials, and installing (where applicable) and "paying for the material itself." See 49 CFR 26.55(c)(1).

The approval to use joint checks constitutes a commitment to provide further information to WisDOT, upon request by staff. WisDOT will allow the use of joint checks when the following conditions are met:

- a. The Prime Contractor must request permission to use joint checks from the DBE Office by submitting the Application to Use Joint Checks.
  - (1) Request should be made when the DBE Commitment or the Request to Sublet is submitted; the request will not be considered if submitted after the DBE Subcontractor starts its work.
  - (2) Approval/Permission must be granted prior to the issuance of any joint checks.
  - (3) The payment schedule for the supplier must be presented to the DBE office before the first check is issued.
  - (4) The joint check for supplies must be strictly for the cost of approved supplies.
- b. The DBE subcontractor is responsible for furnishing and/or installing the material/work item and is not an 'extra participant' in the transaction. The DBE firm's role in the transaction cannot be limited solely to signing the check(s) to release payment to the material supplier. At a minimum, the DBE subcontractor's tasks should include the following:
  - (1) The DBE subcontractor (not the prime/payor) negotiates the quantities, price, and delivery of materials.
  - (2) The DBE subcontractor consents to sign/release the check to the supplier by signing the Application to Use Joint Checks after establishing the conditions and documentation of payment within the subcontract terms or in a separate written document.
- c. The Prime contractor/payor acts solely as a guarantor.
  - (1) The Prime Contractor agrees to furnish the check used for the payment of materials/supplies under the contract.
  - (2) The prime contractor/payor cannot require the subcontractor to use a specific supplier or the prime contractor's negotiated unit price.

## 15. Payment

Costs for conforming to this Additional Special Provision (ASP) and any associated DBE requirements are incidental to the contract.

## Appendix A

### Substantive Conversation Guidelines

The substantive conversation is critical to all bidders' demonstration of good faith effort to meet the DBE goal prior to bid opening. Relationship building between primes and subcontractors is crucial to DBE goal attainment. Responsible bidders seek to build rapport with potential DBE subcontractors to understand capacity, areas of expertise, and assess contracting feasibility. Bidders who compete for WisDOT contracts are specialty contractors responding to a growing and changing contract environment. Just as these specialists are responsible for care of the roads, they are likewise responsible for contributing to the health of the industry. The substantive conversation drives collaboration that will build industry health and capacity. The following is intended to provide guidance for such discussions but is not an exhaustive list. Contractors are encouraged to incorporate their existing strategies for cultivating business relationships as well.

Prior to Bid Opening- this discussion should happen as early as possible (WisDOT advertisements are released 5 weeks prior to each Let)

- Determine DBE subcontractor's interest in quoting
- If response indicates inexperience with quoting- offer support/assistance to the DBE in understanding the industry including fundamentals a subcontractor needs to know, required reading and/or resources.
- Assess their interest and experience in the road construction industry by asking questions such as:
  1. Have you competed for other WisDOT contracts? Ratio of competed/to wins
  2. Have you performed on any transportation industry contracts (locally or with other states)?
  3. What the largest contract you've completed?
  4. Have you worked in the industry: apprentice, journeyman, safety, inspection etc.?
  5. Does this project fit into your schedule? Are you working on any contracts now?
  6. Have you reviewed a copy of the plans? Are you comfortable performing within the scope and quantity considerations of this contract?
  7. What region do you work in? Home base?
  8. Which line items are you considering?
  9. Have you read/are you familiar with WisDOT Standard Specifications? Construction Material Manual?
  10. Do you understand where your work fits in the project schedule, project phases?

Following Bid Opening- this discussion can happen at any time

1. After reviewing their quote, note the following in your discussion:
  - Does the quote look complete? Irregular?
  - Are there errors in the quote? Are items very high or very low?
  - In general, does the quote look competitive?
2. Questions and Advice for the bidder to share with the potential DBE subcontractor:
  - What line items would typically be in a competitive quote for a subcontractor of their specialty?
  - How many employees and what is their role/experience/expertise in your firm?
  - Do you have resources for labor (union member, family-based, community-resourced) and capital (banking relationship, bond agent, CPA)?
  - Where have you worked: cities, states, government, commercial, residential/private sector, etc. Explain similarities or differences.
  - Refer them to reliable, trusted, industry resources that can educate or connect them to relevant resources, education/certification resources, more appropriate contract opportunities.
  - Discussion about prime contract and subcontract liability, critical path items, contract quantities, schedule risks, and potential profit/loss (for upcoming known projects or in general).
  - Discussion of bonding, insurance, and overall business risk considerations.

**APPENDIX B**  
**Sample Contractor Solicitation Letter Page 1**  
*This sample is provided as a guide not a requirement*

**GFESAMPLE MEMORANDUM**

**TO:** DBE FIRMS  
**FROM:** POTENTIAL PRIME CONTRACTOR OR MAJOR SUBCONTRACTOR  
**SUBJECT:** **REQUEST FOR DBE QUOTES**  
**LET DATE & TIME**  
**DATE:** MONTH DAY YEAR  
**CC:** DBE OFFICE ENGINEER

Our company is considering bidding on the projects indicated on the next page, as a prime and/or a subcontractor for the Wisconsin Department of Transportation **Month- date -year** Letting. Page 2 lists the projects and work items that we may subcontract for this letting. We are interested in obtaining subcontractor quotes for these projects and work categories. Also note that we are willing to accept quotes in areas we may be planning to perform ourselves as required by federal rules.

Please review page 2, respond whether you plan to quote, highlight the projects and work items you are interested in performing and return it via fax or email within 3 days. Plans, specifications and addenda are available through WisDOT at the DBE Support Services office or at the Highway Construction Contract Information (HCCI) site at <http://roadwaystandards.dot.wi.gov/hcci/>

Your quote should include all of the costs required to complete the items you propose to perform including labor, equipment, material, and related bonding or insurance. The quote should note items that you are DBE certified to perform, tied items, and any special terms. Page 2, with the indicated projects and items you plan to quote, should be used as a cover sheet for your quote.

Please make every effort to have your quotes into our office by **time deadline** the prior to the letting date. ***Make sure the correct letting date, project ID and proposal number, unit price and extension are included in your quote.*** We prefer quotes be sent via SBN but **prime's alternatives** are acceptable. Our office hours are **include hours and days**.

Please call our office as soon as possible prior to the letting if you need information/clarification to prepare your quote at **contact number**.

If you wish to discuss or evaluate your quote in more detail, contact us after the contract is awarded. Status of the contract can be checked at WisDOT's HCCI site at <http://roadwaystandards.dot.wi.gov/hcci/>  
 All questions should be directed to:

Project Manager, John Doe, Phone:  
 (000) 123-4567  
 Email: [Joe@joetheplumber.com](mailto:Joe@joetheplumber.com)  
 Fax: (000) 123- 4657



**Sample Contractor Solicitation Letter Page 2**  
*This sample is provided as a guide not a requirement*  
 REQUEST FOR QUOTE

**Prime's Name:** \_\_\_\_\_  
**Letting Date:** \_\_\_\_\_  
**Project ID:** \_\_\_\_\_

**Please check all that apply**

- Yes, we will be quoting on the projects and items listed below
- No, we are not interested in quoting on the letting or its items referenced below
- Please take our name off your monthly DBE contact list
- We have questions about quoting this letting. Please have someone contact me at this number

Prime Contractor 's Contact Person:

DBE Contractor Contact Person:



Phone: \_\_\_\_\_

Phone: \_\_\_\_\_

Fax: \_\_\_\_\_

Fax: \_\_\_\_\_

Email: \_\_\_\_\_

Email: \_\_\_\_\_

**Please circle the jobs and items you will be quoting below**

Proposal No.	1	2	3	4	5	6	7
County							

**WORK DESCRIPTION:**

Clearing and Grubbing	X		X	X		X	X
Dump Truck Hauling	X		X	X		X	X
Curb & Gutter/Sidewalk, Etc.	X		X	X		X	X
Erosion Control Items	X		X	X		X	X
Signs and Posts/Markers	X		X	X		X	X
Traffic Control		X	X	X		X	X
Electrical Work/Traffic Signals		X	X	X		X	
Pavement Marking		X	X	X	X	X	X
Sawing Pavement		X	X	X	X	X	X
QMP, Base	X	X		X	X	X	X
Pipe Underdrain	X			X			
Beam Guard				X	X	X	X
Concrete Staining							X
Trees/Shrubs	X						X

Again please make every effort to have your quotes into our office by **time deadline** prior to the letting date.

**We prefer quotes be sent via SBN but **prime's preferred alternatives** are acceptable.**

If there are further questions please direct them to the **prime contractor's contact person** at **phone number.**

## Appendix C

### Small Business Network (SBN) Overview

The Small Business Network is a part of the Bid Express® service that was created to ensure that prime bidders have a centralized online location to find subs - including small and disadvantaged business enterprises (DBEs). It is available for prime bidders to use as part of their Basic Service subscription. Within the Small Business Network, **Prime Contractors** can:

1. Easily select proposals, work types and items:
  - a. After adding applicable work types, select items that you wish to quote. Enter the sub-quote quantities and add comments, if desired. Adding or removing items and work types can be done quickly. If needed, you can save the sub-quote for later completion.
2. Create sub-quotes for the subcontracting community:
  - a. Create sub-quotes with ease using the intuitive sub-quote creator. In seven short steps, you can rapidly create a custom sub-quote directed to all subcontractors that bid on the applicable work types. Steps include: provide contact information and sub-quote expiration date, select letting and proposal, add work types and items, specify terms and conditions, upload attachments, and select vendors.
  - b. Create a sub-quote to send to subcontractors or suppliers that lists the items in a proposal that you want quoted
  - c. Create an unlimited number of sub-quotes for items you want quoted, and optionally mark them as a DBE preferred request.
  - d. Add attachments to sub-quotes.
3. View sub-quote requests & responses:
  - a. After logging into the Bid Express service, you can quickly review all of your sub-quote requests and all unsolicited sub-quote requests from subcontractors. To simplify the Small Business Network home screen, sub-quote requests can be hidden with one click if they are not applicable.
  - b. View or receive unsolicited sub-quotes that subcontractors have posted, complete with terms, conditions and pricing.
4. View Record of Subcontractor Outreach Effort:
  - a. For each sub-quote produced, a *Record of Subcontractor Outreach Effort* is generated that shows the response statistics for a particular sub-quote. If accepted by the letting agency, this report may serve as proof of a “Good Faith” effort in reaching out to the DBE community.
  - b. Easily locate pre-qualified and certified small and disadvantaged businesses.
  - c. Advertise to small and disadvantaged businesses more efficiently and cost effectively.
  - d. Document your interactions with subs/DBEs by producing an Outreach Report (may be accepted as proof of DBE outreach at the discretion of each agency).

The Small Business Network is a part of the Bid Express® service that was created to ensure that small businesses have a centralized area to access information about upcoming projects. It can help small businesses learn more about opportunities, compete more effectively, network with other contractors and subcontractors, and win more jobs. **DBE firms can:**

1. View and reply to sub-quote requests from primes:
  - a. After logging into the Bid Express service, you can quickly review all incoming sub-quote requests and all unsolicited sub-quotes created by your company. Receive notifications by selected work type. To simplify on the Small Business Network home screen, sub-quote requests can be filtered by work types relevant to your interests or hidden with one click if they are not applicable.
2. Select items when responding to sub-quote requests from primes:
  - a. You have the freedom to choose and price any number of items when responding to a sub-quote request. Quantities can be modified, and per-item comments are also available.
  - b. View requests for sub-quotes for work that primes have posted for projects they are bidding, add your pricing, terms, and conditions, and submit completed sub-quotes to the requesting primes.
  - c. Add attachments to a sub-quote.
3. Create and send unsolicited sub-quotes to specific contractors:
  - a. Create unsolicited sub-quotes with ease using the intuitive sub-quote creator. In eight short steps, you can rapidly create a custom sub-quote directed at any number of specific vendors of your choosing. Steps include: provide contact information and sub-quote expiration date, select letting and proposal, add work types and items, specify terms and conditions, upload attachments, and select vendors.
4. Easily select and price items for unsolicited sub-quotes:
  - a. After adding applicable work types, select items that you wish to quote. The extended price calculates automatically, cutting out costly calculation errors. Comments can be provided on a per-item basis as well.
  - b. Create an unsolicited sub-quote that lists the items from a proposal that you want to quote, include pricing, terms and conditions, and send it to selected prime/plan holder.
  - c. Add attachments to a sub-quote.
  - d. Add unsolicited work items to sub-quotes that you are responding to.
5. Easy Access to Valuable Information
  - a. Receive a confirmation that your sub-quote was opened by a prime.
  - b. View Bid Tab Analysis data from past bids, including the high, average and low prices of items.
  - c. View important notices and publications from DOT targeted to small and disadvantaged businesses.
6. Accessing Small Business Network for WisDOT contracting opportunities
  - a. If you are a contractor not yet subscribing to the Bid Express service, go to [www.bidx.com](http://www.bidx.com) and select "Order Bid Express." The Small Business Network is a part of the Bid Express Basic Service.
  - b. DBE firms can request a Bid Express Small Business Network Account at no cost by calling 414-438-458

## APPENDIX D

### Good Faith Effort Evaluation Measures *by categories referenced in DBE regulations*

Bidders must demonstrate that they took all necessary and reasonable steps to achieve the assigned DBE contract goal. For each contract, all bidders must submit documentation indicating the goal has been met or if falling short of meeting the assigned goal, must request a DBE Goal Waiver and document all efforts employed to secure DBE subcontractor participation on Form DT1202.

DBE staff analyze the bidder's documented good faith efforts to determine if action taken was sufficient to meet the goal. Sufficiency is measured contract-by-contract. WisDOT evaluates active and aggressive efforts, quality, quantity, scope, intensity, and appropriateness of the bidder's efforts as a scale of the principles of Good Faith outlined in 49 CFR Part 26, Appendix A. Additional emphasis is placed on the bidder's demonstration of timely submission of documentation and communication with DBE subcontractors, and business development initiatives undertaken to support DBE firm growth.

The following is a sample of good faith effort activities that are rated according to the accompanying rubric. Contractors are encouraged to identify additional activities that align with their business type(s).

- Personal, tailored solicitation to firms that specialize in work types planned or desired for subcontracting
- Follow up to initial solicitation via email or phone
- Substantive conversation including topics such as contract liability, critical path work items, schedule risks, and potential profit/loss
- SBN utilization including posting quotes
- Review and response to DBE quotes including provision of information about plans, specifications, and requirements as applicable
- Documentation requesting subcontractors support DBE goal by solicitation and inclusion of DBE subcontractor quotes
- Responsive and timely submission of organized documentation
- Analysis of number of DBE firms who do work types that you typically subcontract
- Analysis of number of DBE firms who reside in geographical areas where prime seeks work
- Analysis of firms who express interest in bidding/quoting including the number of firms who declined your solicitation
- Reference check of DBE subcontractor work or training (documentation of questions and response required)
- Number of different efforts undertaken to meet the assigned DBE goal as documented in accompanying Form DT1202
- Submission of all DBE quotes received matched with a variety of work to be performed by DBEs
- Number and names of DBE firms provided written advice, or referral to industry-specific business development resources
- Overall pattern of DBE utilization on all WisDOT contracts which may include contracting with municipalities
- Documentation of resources expended to meet assigned DBE goal (#of hours, staff titles, average pay rate, actions taken)
- Analysis of subcontractable work items to be completed by prime beyond prime contractor's 30%
- Risk analysis of work items that are typically in tied quotes that could be unbundled
- List of contract work items in smallest economically feasible units, identifying schedule impact
- Submission of a Gap Analysis identifying DBE skillset and/or industry needs
- Staff training in EEO and Civil Rights laws as documented in training logs
- Written Capacity Assessment completed with DBE firm documenting its ability to perform the work quoted
- DBE engagement efforts beyond simple solicitation that include a substantive discussion, initiated as early in the acquisition process as possible (*points added for each day prior to letting*)
- Outreach and marketing efforts with minority, women, and veteran-focused organizations at least 10 days prior to bid opening
- Active involvement in WisDOT's Business Development Program, TrANS training, facilitated networking efforts, workshops
- Customized teaching/training efforts for future opportunities with DBE subcontractor, contract specific and/or annually
- Introduction and reference provided for DBE subcontractor to a prime who has not previously contracted with the DBE firm
- Prime utilization of a DBE subcontractor the prime has not contracted with previously
- Written referral/recommendation to bond/insurance agents, manufacturer, supplier
- Documented efforts fostering DBE participation through administrative and/or technical assistance
- Evidence of negotiation with the DBE firm about current and future Let opportunities
- Recommendation of local and state services that support small business and access to opportunity: DOA, SBA, WEDC, WPI, etc.
- Advice on bonding, lines of credit, or insurance as required to complete the items quoted and contract requirements

**GFE EVALUATION RUBRIC – PHASE 1**

	<b>Active &amp; Aggressive Category</b>	<b>Quality Category</b>	<b>Quantity Category</b>	<b>Scope &amp; Intensity Category</b>	<b>Timing Category</b>	<b>Business Develop't Efforts</b>	<b>Total=</b>
<b>Solicitation Documentation</b>							
<b>Selected Work Items Documentation</b>							
<b>Documentation of Project Information provided to Interested DBEs</b>							
<b>Documentation of Negotiation with Interested DBEs</b>							
<b>Documentation of Sound Reason for Rejecting DBEs</b>							
<b>Documentation of Assistance to Interested DBEs- bonding, credit, insurance, equipment, supplies/materials</b>							
<b>Documentation of Outreach to Minority, Women, and Community organizations and other DBE Business Development Support</b>							
<b>Documentation of other GFE activities</b>							
<b>Overall Total=</b>							

## GFE EVALUATION RATING LEGEND – PHASE 1 – Initial Review

**ACTIVE & AGGRESSIVE:** Demonstrated through engaged and assertive activity

**QUALITY:** Demonstrated through essential character of conscientious and serious activity

**QUANTITY:** Demonstrated through a measurable number of activities

**SCOPE & INTENSITY:** Demonstrated through a rigorous approach to an appropriate and purposeful range of activities

**TIMING:** Demonstrated through engagement efforts beyond simple solicitation, initiated early in the process

**BUSINESS DEVELOPMENT INITIATIVES:** Demonstrated by efforts to support business growth and health of DBEs

### Rating Scale

- Each qualifying activity is worth 5 points per Category
  - **Pro Forma efforts= 0-50 points**  
Perfunctory effort characterized by routine or superficial activities
  - **Bona Fide= 55+ points**  
Genuine effort characterized by sincere and earnest activities

## GFE EVALUATION – PHASE 2 – Team Review

### DBE Office completes:

- Review of quote comparisons submitted by Prime
- Bid analysis to confirm if any bid submitted met the DBE goal
- Review average of other bidders DBE goal achievement
- Team review of combined efforts documented in Phase 1 and 2 by apparent low bidder

Excerpt from Appendix A to 49 CFR Part 26:

V. In determining whether a bidder has made good faith efforts, it is essential to scrutinize its documented efforts. At a minimum, you must review the performance of other bidders in meeting the contract goal. For example, when the apparent successful bidder fails to meet the contract goal, but others meet it, you may reasonably raise the question of whether, with additional efforts, the apparent successful bidder could have met the goal. If the apparent successful bidder fails to meet the goal, but meets or exceeds the average DBE participation obtained by other bidders, you may view this, in conjunction with other factors, as evidence of the apparent successful bidder having made good faith efforts. As provided in §26.53(b)(2)(vi), you must also require the contractor to submit copies of each DBE and non-DBE subcontractor quote submitted to the bidder when a non-DBE subcontractor was selected over a DBE for work on the contract to review whether DBE prices were substantially higher; and contact the DBEs listed on a contractor's solicitation to inquire as to whether they were contacted by the prime. Pro forma mailings to DBEs requesting bids are not alone sufficient to satisfy good faith efforts under the rule.

## **APPENDIX E**

### **Good Faith Effort Best Practices**

This list is not a set of requirements; it is a list of potential strategies

#### **Primes**

- Ø Prime contractor open houses inviting DBE firms to see the bid “war room” or providing technical assistance.
- Ø Participate in speed networking and mosaic exercises as arranged by DBE office.
- Ø Host information sessions not directly associated with a bid letting.
- Ø Participate in a formal mentor protégé or joint venture with a DBE firm.
- Ø Participate in WisDOT advisory committees i.e. TRANSAC, or Mega Project committee meetings.
- Ø Facilitate a small group DBE ‘training session’ clarifying how your firm prepares for bid letting, evaluates subcontractors, preferred qualifications, and communication methods.
- Ø Encourage subcontractors to solicit and highlight DBE participation in their quotes to you.
- Ø Quality of communication, not quantity creates the best results. Contractors should be thorough in communicating with DBE firms before the bid and provide any assistance requested to assure best possible bid.

#### **DBE**

- Ø DBE firms should contact primes as soon as possible with questions regarding their quotes or bid; seven days prior is optimal.
- Ø Continually check for contract addendums on the HCCI website through the Thursday prior to letting to stay abreast of changes.
- Ø Review the status of contracts on the HCCI website reviewing the ‘apparent low bidder’ list and bid tabs at a minimum.
- Ø Prepare a portfolio or list of related projects and prime and supplier references; be sure to note transportation related projects of similar size and scope, firm expertise and staffing.
- Ø Participate in DBE office assessment programs.
- Ø Participate on advisory and mega-project committees.
- Ø Sign up to receive the DBE Contracting Update.
- Ø Consider membership in relevant industry or contractor organizations.
- Ø Active participation is a must. Quote as many projects as you can reasonably work on; quoting the primes and bidding as a prime with the Department are the only ways to get work.



**APPENDIX F**  
**Good Faith Effort Evaluation Guidance**  
*Appendix A of 49 CFR Part 26*

I. When, as a recipient, you establish a contract goal on a DOT-assisted contract for procuring construction, equipment, services, or any other purpose, a bidder must, in order to be responsible and/or responsive, make sufficient good faith efforts to meet the goal. The bidder can meet this requirement in either of two ways. First, the bidder can meet the goal, documenting commitments for participation by DBE firms sufficient for this purpose. Second, even if it doesn't meet the goal, the bidder can document adequate good faith efforts. This means that the bidder must show that it took all necessary and reasonable steps to achieve a DBE goal or other requirement of this part which, by their scope, intensity, and appropriateness to the objective, could reasonably be expected to obtain sufficient DBE participation, even if they were not fully successful.

II. In any situation in which you have established a contract goal, Part 26 requires you to use the good faith efforts mechanism of this part. As a recipient, you have the responsibility to make a fair and reasonable judgment whether a bidder that did not meet the goal made adequate good faith efforts. It is important for you to consider the quality, quantity, and intensity of the different kinds of efforts that the bidder has made, based on the regulations and the guidance in this Appendix.

The efforts employed by the bidder should be those that one could reasonably expect a bidder to take if the bidder were actively and aggressively trying to obtain DBE participation sufficient to meet the DBE contract goal. Mere pro forma efforts are not good faith efforts to meet the DBE contract requirements. We emphasize, however, that your determination concerning the sufficiency of the firm's good faith efforts is a judgment call. Determinations should not be made using quantitative formulas.

III. The Department also strongly cautions you against requiring that a bidder meet a contract goal (i.e., obtain a specified amount of DBE participation) in order to be awarded a contract, even though the bidder makes an adequate good faith efforts showing. This rule specifically prohibits you from ignoring bona fide good faith efforts.

IV. The following is a list of types of actions which you should consider as part of the bidder's good faith efforts to obtain DBE participation. It is not intended to be a mandatory checklist, nor is it intended to be exclusive or exhaustive. Other factors or types of efforts may be relevant in appropriate cases.

A. (1) Conducting market research to identify small business contractors and suppliers and soliciting through all reasonable and available means the interest of all certified DBEs that have the capability to perform the work of the contract. This may include attendance at pre-bid and business matchmaking meetings and events, advertising and/or written notices, posting of Notices of Sources Sought and/or Requests for Proposals, written notices or emails to all DBEs listed in the State's directory of transportation firms that specialize in the areas of work desired (as noted in the DBE directory) and which are located in the area or surrounding areas of the project.

(2) The bidder should solicit this interest as early in the acquisition process as practicable to allow the DBEs to respond to the solicitation and submit a timely offer for the subcontract. The bidder should determine with certainty if the DBEs are interested by taking appropriate steps to follow up initial solicitations.

B. Selecting portions of the work to be performed by DBEs in order to increase the likelihood that the DBE goals will be achieved. This includes, where appropriate, breaking out contract work items into economically feasible units (for example, smaller tasks or quantities) to facilitate DBE participation, even when the prime contractor might otherwise prefer to perform these work items with its own forces. This may include, where possible, establishing flexible timeframes for performance and delivery schedules in a manner that encourages and facilitates DBE participation.

C. Providing interested DBEs with adequate information about the plans, specifications, and requirements of the contract in a timely manner to assist them in responding to a solicitation with their offer for the subcontract.

D. (1) Negotiating in good faith with interested DBEs. It is the bidder's responsibility to make a portion of the work available to DBE subcontractors and suppliers and to select those portions of the work or material needs consistent with the available DBE subcontractors and suppliers, so as to facilitate DBE participation. Evidence of such negotiation includes the names, addresses, and telephone numbers of DBEs that were considered; a description of the information provided regarding the plans and specifications for the work selected for subcontracting; and evidence as to why additional Agreements could not be reached for DBEs to perform the work.

(2) A bidder using good business judgment would consider a number of factors in negotiating with subcontractors, including DBE subcontractors, and would take a firm's price and capabilities as well as contract goals into consideration. However, the fact that there may be some additional costs involved in finding and using DBEs is not in itself sufficient reason for a bidder's failure to meet the contract DBE goal, as long as such costs are reasonable. Also, the ability or desire of a prime contractor to perform the work of a contract with its own organization does not relieve the bidder of the responsibility to make good faith efforts. Prime contractors are not, however, required to accept higher quotes from DBEs if the price difference is excessive or unreasonable.

E. (1) Not rejecting DBEs as being unqualified without sound reasons based on a thorough investigation of their capabilities. The contractor's standing within its industry, membership in specific groups, organizations, or associations and political or social affiliations (for example union vs. non-union status) are not legitimate causes for the rejection or non-solicitation of bids in the contractor's efforts to meet the project goal. Another practice considered an insufficient good faith effort is the rejection of the DBE because its quotation for the work was not the lowest received. However, nothing in this paragraph shall be construed to require the bidder or prime contractor to accept unreasonable quotes in order to satisfy contract goals.

(2) A prime contractor's inability to find a replacement DBE at the original price is not alone sufficient to support a finding that good faith efforts have been made to replace the original DBE. The fact that the contractor has the ability and/or desire to perform the contract work with its own forces does not relieve the contractor of the obligation to make good faith efforts to find a replacement DBE, and it is not a sound basis for rejecting a prospective replacement DBE's reasonable quote.

F. Making efforts to assist interested DBEs in obtaining bonding, lines of credit, or insurance as required by the recipient or contractor.

G. Making efforts to assist interested DBEs in obtaining necessary equipment, supplies, materials, or related assistance or services.

H. Effectively using the services of available minority/women community organizations; minority/women contractors' groups; local, State, and Federal minority/women business assistance offices; and other organizations as allowed on a case-by-case basis to provide assistance in the recruitment and placement of DBEs.

V. In determining whether a bidder has made good faith efforts, it is essential to scrutinize its documented efforts. At a minimum, you must review the performance of other bidders in meeting the contract goal. For example, when the apparent successful bidder fails to meet the contract goal, but others meet it, you may reasonably raise the question of whether, with additional efforts, the apparent successful bidder could have met the goal. If the apparent successful bidder fails to meet the goal, but meets or exceeds the average DBE participation obtained by other bidders, you may view this, in conjunction with other factors, as evidence of the apparent successful bidder having made good faith efforts. As provided in §26.53(b)(2)(vi), you must also require the contractor to submit copies of each DBE and non-DBE subcontractor quote submitted to the bidder when a non-DBE subcontractor was selected over a DBE for work on the contract to review whether DBE prices were substantially higher; and contact the DBEs listed on a contractor's solicitation to inquire as to whether they were contacted by the prime. Pro forma mailings to DBEs requesting bids are not alone sufficient to satisfy good faith efforts under the rule.

VI. A promise to use DBEs after contract award is not considered to be responsive to the contract solicitation or to constitute good faith efforts.

[79 FR 59600, Oct. 2, 2014]

**APPENDIX G**

**(SAMPLE) Forms DT1506 and DT1202**

**COMMITMENT TO SUBCONTRACT TO DBE  
ATTACHMENT A**

**CONFIRMATION OF PARTICIPATION**

Project I.D.:	Proposal Number:
Letting Date:	

Name of DBE Firm Participating in this Contract:	
Name of the Prime/Subcontractor who hired the DBE Firm: <i>(list all names of tiers if more than one)</i>	
Type of Work or Type of Material Supplied:	
Total Subcontract Value:	Total DBE Credit Value:

<p><b>FOR PRIME CONTRACTORS ONLY:</b> I certify that I made arrangements with the participating DBE firm to perform the type of work listed or supply the material indicated above for the subcontract value listed above.</p>	Prime Contractor Representative's Signature
	Prime Contractor Representative's Name (Print Name)
	Prime Contractor (Print Company Name)
	Date

<p><b>FOR PARTICIPATING DBE FIRMS ONLY:</b> I certify that I made arrangements with the Prime Contractor or the Hiring Contractor to perform the type of work or supply the material indicated above for the subcontract value listed above.</p> <p><b>FOR DBE TRUCKING FIRMS ONLY:</b> I certify that I will utilize, for DBE credit, only trucks listed on my WisDOT approved Schedule of Owned/Leased Vehicles for DBE Credit form and I will be utilizing the number of trucks as listed below.</p>	Participating DBE Firm Representative's Signature & Date
	Participating DBE Firm Representative's Name (Print Name)
	Participating DBE Firm (Print Company Name)
	DBE Firm's Address:

# Owned Trucks	# Leased Trucks	# DBE-Owned Leased Trucks	# Non-DBE-Owned Leased Trucks



**DOCUMENTATION OF GOOD FAITH EFFORT**  
 Wisconsin Department of Transportation  
 DT1202.....3/2020



Project ID .....	Proposal No. .....	Letting .....
Prime Contractor .....	County .....	
Person Submitting Document .....	Telephone Number .....	
Address .....	Email Address .....	

All bidders must undertake necessary and reasonable steps to achieve the assigned DBE contract goal per federal regulatory guidance at 49 CFR Part 26. Bidders use this form to document all efforts employed to meet the assigned goal as a record of contractor good faith efforts (GFE). Refer to ASP3 or 49 CFR Part 26 for guidance on actions that demonstrate good faith effort.

It is critical to list all efforts, attach documentation, and follow the instructions to complete this submission. Documentation of good faith effort includes copies of each DBE and non-DBE subcontractor quote submitted to the bidder for the same line items. Utilize the sample documentation logs to document and organize efforts.

Submit good faith effort documentation per ASP-3 guidelines.

**Instructions:** Provide a narrative description of all activities pursued to demonstrate good faith efforts, any corresponding documentation, and applicable explanation on separate pages. Include the following items, organized in the order listed below.

**1. Solicitation Documentation:**

- a. **Purpose:** To identify all reasonable and available activities the bidder performed to solicit the interest of all certified DBEs who have the capacity and ability to perform work on the project. All solicitation efforts should begin as early as possible to ensure DBEs have ample time to respond and ask questions.
- b. **Action:** Identify and list all activities engaged in to solicit DBEs using all reasonable and available means such as written notice and follow-up communications; substantive conversations; pre-bid meetings; networking events; market research; advertising.

**2. Selected Work Items Documentation:**

- a. **Purpose:** To ensure that all work items are broken out into economically feasible units to facilitate DBE participation. This must occur even when you prefer to perform the work yourself.
- b. **Action:** Identify economically feasible work units to be performed by DBEs to include activities such as: list of work items to be performed; breaking up of large work items into smaller tasks or quantities; flexible time frames for performance and delivery schedules.

**3. Documentation of Project Information provided to Interested DBEs:**

- a. **Purpose:** To provide interested DBEs with adequate information about the plans, specifications, and any other contractual requirements in a timely manner to assist DBEs in response to solicitation.
- b. **Action:** Provide DBEs access to plans, specifications, and other contract requirements. Early solicitation allows ample opportunity to provide project information, links to Let advertisements, and substantive engagement with DBEs.

**4. → Documentation of Negotiation with Interested DBEs:**

**a. → Purpose:** To ensure that negotiations with interested DBEs were made in good faith providing evidence as to why agreements could not be reached for DBEs to perform work.

**b. → Action:** Provide sufficient evidence to demonstrate that good faith negotiations took place. Merely sending out solicitations requesting bids from DBEs does not constitute sufficient good faith efforts. A bidder using good business judgment considers a number of factors in negotiating with all subcontractors, and the firm's price and capabilities in addition to contract goals are taken into consideration. However, the fact that there may be some additional costs involved in finding and using DBEs is not in itself sufficient reason for failing to meet the DBE goal as long as costs are reasonable. (see 49 CFR Part 26 Appendix A)

**5. → Documentation of Sound Reason for Rejecting DBEs:**

**a. → Purpose:** To ensure that bidders avoid rejecting DBEs as unqualified without sound reasons. Reasons for rejection must be based on thorough investigation of DBE capabilities.

**b. → Action:** Provide sufficient evidence to demonstrate that DBE was rejected for sound reasons such as past performance, relevant business experience and stability, safety record, business ethic and integrity, technical capacity, other tangible factors.

**6. → Documentation of Assistance to Interested DBEs - Bonding, Credit, Insurance, Equipment, Supplies/Materials:**

**a. → Purpose:** To assist interested DBEs in obtaining bonds, lines of credit, insurance, equipment, supplies, materials, and other assistance or services.

**b. → Action:** Assist interested DBEs in obtaining bonding, lines of credit or insurance, and provide technical assistance or information related to plans, specifications, and project requirements. Assist DBEs in obtaining equipment, supplies, materials or other services related to meeting project requirements (excluding supplies or equipment the DBE purchases from the prime).

**7. → Documentation of outreach to Minority, Women, and Community Organizations and other DBE Business Development Support:**

**a. → Purpose:** To effectively use the services of minority, women, and community organizations as well as contractors' groups, local, state, and federal business assistance offices and organization that provide assistance in recruiting and supporting DBEs, as well as participation in activities that support DBE business development.

**b. → Action:** Contact organizations and agencies for assistance in contacting, recruiting, and providing support to DBE subcontractors, suppliers, manufacturers, and truckers at least 14 days before bid opening. Participate in or host activities such as networking events, mentor-protégé programs, small business development workshops, and others consistent with DBE support.

Return to:  
Wisconsin Department of Transportation  
DBE Program Office  
PO Box 7965  
Madison, WI 53707-7965  
DBE\_Alert@dot.wi.gov

I certify that I have utilized comprehensive good faith efforts to solicit and utilize DBE firms to meet the DBE participation requirements of this contract proposal, as demonstrated by my responses and as specified in Additional Special Provision 3 (ASP-3).

I certify that the information given in the Documentation of Good Faith Efforts is true and correct to the best of my knowledge and belief.

I further understand that any willful falsification, fraudulent statement, or misrepresentation will result in appropriate sanctions, which may involve debarment and/or prosecution under applicable state (Trans 504) and Federal laws.

		(Bidder/Authorized Representative Signature)
	*****	(Print Name)
	*****	(Title)



### Good-Faith-Effort-- Sample-Documentation-Logs

The sample logs below are provided as guides rather than exhaustive list. See ASP3, Appendix A for additional examples of demonstrable good faith efforts. Attach documentation for each activity listed.

Acceptable forms of documentation include copies of solicitations sent to DBEs, notes from substantive conversations and negotiations with DBEs, copies of advertisements placed, email communications, all quotes received from DBEs and from all subcontractors who were considered alongside DBE quotes, proof of attendance at applicable networking events; flyers for events or workshops for DBEs offered by the prime, and other physical records of good faith efforts activities.

#### SOLICITATION LOG

Date	Activity	Name of DBE Solicited	Follow-up
4/1/2020	Sent May Let solicitation	Winterland Electric	Spoke with Mark Winterland on 4/15/20 to ask if he would quote.

#### SELECTED WORK ITEMS SOLICITED LOG

Work Type	DBE Firm	Contact Person	Date	Contact Mode
Pavement Marking	ABC Marking	Leslie Lynch	4/1/2020	Email; phone
	#1 Marking Co.	Mark Smart	4/1/2020	Email; left VM
Electrical	Winterland Electric	Tabitha Tinker	4/3/2020	Email; left VM
	Superstar Wiring	Jose Huascar	4/3/2020	Email; phone

#### INFORMATION PROVIDED LOG

Request Date	DBE Firm	Information Requested & Provided	Response Date
4/1/2020	Winterland Electric	Requested info on electrical requirements; provided plan and link to specs	4/3/2020
4/21/2020	Absolute Construction	Wanted to know how and when supplies are paid for by WisDOT; referred to spec that covers stockpiling	4/21/2020

#### NEGOTIATIONS LOG

Date	DBE Firm	Contact Name	Work Type	Quotes Rec'd?	Considered for project?	If not selected, why?
4/12/2020	ABC Landscape	John Dean	Erosion Control	Yes	No	Cannot perform all items
4/17/2020	Wild Ferns	Sandy Lynn	Erosion Control	Yes	Yes	
4/20/2020	#1 Marking	Mark Smart	Electrical	Yes	Yes	

#### ASSISTANCE LOG

Date	DBE Firm	Contact Person	Assistance Provided
4/1/2020	ABC Sawing	Jackie Swiggle	Informed DBE on how to obtain bonding
4/17/2020	Supreme Construction	Winston Walters	Provided contact for wholesale supply purchase

#### OUTREACH & BUSINESS DEVELOPMENT LOG

Date	Agency/Organization Contacted	Contact Person	Assistance Requested
4/1/2020	Women in Construction	LaTonya Klein	Contact information for woman-owned suppliers
4/28/2020	WBIC	Sam Smith	Asked for information to provide to DBE regarding financing programs through WBIC

Official Form DT1202 can be found here: [www.wisconsin.gov/DBEcontracting](http://www.wisconsin.gov/DBEcontracting)

**ADDITIONAL SPECIAL PROVISION 4**

This special provision does not limit the right of the department, prime contractor, or subcontractors at any tier to withhold payment for work not acceptably completed or work subject to an unresolved contract dispute.

**Payment to First-Tier Subcontractors**

Within 10 calendar days of receiving a progress payment for work completed by a subcontractor, pay the subcontractor for that work. The prime contractor may withhold payment to a subcontractor if, within 10 calendar days of receipt of that progress payment, the prime contractor provides written notification to the subcontractor and the department documenting "just cause" for withholding payment.

The prime contractor is not allowed to withhold retainage from payments due subcontractors.

**Payment to Lower-Tier Subcontractors**

Ensure that subcontracting agreements at all tiers provide prompt payment rights to lower-tier subcontractors that parallel those granted first-tier subcontractors in this provision.

**Additional Special Provision 6**  
**ASP 6 - Modifications to the standard specifications**

*Make the following revisions to the standard specifications:*

**415.3.16 Tolerance in Pavement Thickness**

*Replace the entire text with the following effective with the November 2021 letting:*

**415.3.16.1 General**

- (1) Construct the plan thickness or thicker. The department will accept pavement thickness based on the results of department-performed acceptance testing conforming to:

Magnetic Pulse Induction .....	CMM 870: ASTM E3209 WTM
Probing.....	CMM 870: WTP C-002
Preplacement Measurement .....	CMM 870: WTP C-003

**415.3.16.2 Pavement Units**

**415.3.16.2.1 Basic Units**

- (1) Basic unit is defined as a slip formed, single lane, with a minimum lane width of 10 feet, measured, from the pavement edge to the adjacent longitudinal joint; from one longitudinal joint to the next; or between pavement edges if there is no longitudinal joint.

**415.3.16.2.2 Special Units**

- (2) Establish special units for areas of fillets, intersections, gaps, gores, shoulders, ramps, pavement lanes less than 10 feet wide and other areas not included in basic units.

**415.3.16.3 Test Plate Locations**

- (1) Place department-furnished test plates. Within 5 business days after paving, enter the sequential number and associated position data into MRS available at:

<http://www.atwoodsystems.com/>

- (2) Contractor will maintain plate location markings for 10 business days after paving.

**415.3.16.4 Acceptance Testing**

**415.3.16.4.1 Basic Units**

**415.3.16.4.1.2 Magnetic Pulse Induction**

- (1) The department will measure thickness within 10 business days of paving. Upon completion of the project thickness testing, the department will provide the test results to the contractor within 5 business days.
- (2) Department will establish a project reference plate at the start of each paving stage. Project reference plate will be measured before each day of testing. Department will notify the contractor of project reference plate locations before testing.
- (3) If the random plate test result falls within 80 to 50 percent pay range specified in 415.5.2, the department will measure the second plate in that unit. The department will notify the contractor immediately if the average of the 6 readings falls within the 80 to 50 percent pay range.
- (4) If an individual random plate test result is more than 1 inch thinner than contract plan thickness, the pavement is unacceptable. Department will determine limits of unacceptable pavement by performing the following:
- The engineer will test each consecutive plate stationed ahead and behind until the thickness test result is plan thickness or greater.
  - The engineer will direct the contractor to core the hardened concrete to determine the extent of the unacceptable area. In each direction, the contractor shall take cores at points approximately 20 feet from the furthest out of specification plate towards the plate that is plan thickness of greater. Once a core is within 80 to 100 percent pay range, the coring is complete and the limits of unacceptable pavement extend from the stationing between the core test results of 80 to 100 percent payment, inclusive of all unacceptable core and plate test results.
  - The contractor shall perform coring according to AASHTO T24. The department will evaluate the results according to AASHTO T148
  - The contractor shall fill core holes with concrete or mortar.

**415.3.16.4.2 Special Units****415.3.16.4.2.1 Magnetic Pulse Induction**

- (1) The department will measure thickness within 10 business days of paving. Upon completion of the project thickness testing, the department will provide the test results to the contractor within 5 business days.
- (2) Department will establish a project reference plate at the start of each paving stage. Project reference plate will be measured before each day of testing. Department will notify the contractor of project reference plate locations before testing.
- (3) If the random plate test result falls within 80 to 50 percent pay range specified in 415.5.2, the department will measure the second plate in that unit. The department will notify the contractor immediately if the average of the 6 readings falls within the 80 to 50 percent pay range.
- (4) If an individual random plate test result is more than 1 inch thinner than contract plan thickness, the department will measure the second plate in that unit. If both plates are required to be measured, then all six thickness measurements will be averaged for that unit. If the average of the six measurements is more than 1 inch thinner than contract plan thickness, the pavement is unacceptable.

**415.3.16.4.2.2 Probing**

- (1) The department will measure slip form special units during concrete placement. Upon completion of the project thickness testing, the department will provide the test results to the contractor within 5 business days.
- (2) Department will probe 2 random locations within the special unit. The average of the two readings will be the reported measurement for the special unit.

**415.3.16.4.2.3 Preplacement Measurement**

- (1) The department will measure non-slip form special units before concrete placement.
- (2) Thickness corrections will be made to a conforming thickness by reshaping the base aggregate before the pavement is placed.

**415.5.2 Adjusting Pay for Thickness**

Replace the entire text with the following effective with the November 2021 letting:

- (1) The department will adjust pay for pavement thickness under the Nonconforming Thickness Concrete Pavement administrative item as follows:

FOR PAVEMENT THINNER THAN PLAN THICKNESS BY:	PERCENT OF THE CONTRACT UNIT PRICE
> 1/4 inch but <= 1/2 inch	80
> 1/2 inch but <= 3/4 inch	60
> 3/4 inch but <= 1 inch	50

- (2) When pavement of unacceptable final thickness is determined, as specified in 415.3.16.4, the department will direct the contractor to either:
  1. Remove and replace unacceptable concrete pavement to the nearest joint with new concrete pavement of conforming thickness. The department will pay once for the area at the full contract price.
  2. If the unacceptable pavement is less than 100 LF, the department may allow the concrete to remain in place without payment for the unacceptable area.

**460.2.6 Recovered Asphaltic Binders**

Replace paragraph two with the following effective with the November 2021 letting:

- (2) The contractor may replace virgin binder with recovered binder up to the maximum percentage allowed under 460.2.5 without further testing. When the design percent asphalt binder replaced exceeds the allowable limits in 460.2.5, the contractor must:
  - Document adjustments made to the mix design in the mix design submittal.
  - Submit test results that indicate the mixture's asphaltic binder meets or exceeds the upper and lower temperature grade requirements the bid item designates.
    - If only one recycled asphaltic material source is used, furnish one of the following:
      - Test results from extracted and recovered binder from the resultant mixture.
      - Blending charts that indicate the resultant mixture's high and low temperature PG as an interpolation of the percent binder replaced between the virgin binder's and the recycled asphaltic material source binder's high and low temperature PG.
    - If two or more recycled asphaltic material sources are used, furnish test results from extracted and

recovered binder from the resultant mixture.

**501.2.6 Water**

*Retitle with the following effective with the November 2021 letting:*

**501.2.6 Mixing Water**

**501.2.6.2 Requirements**

*Replace paragraph two with the following effective with the November 2021 letting:*

(2) Water from other sources must comply with the following:

Acidity, maximum of 0.1N NaOH to neutralize 200 mL of water; CMM 870: WTP C-001.....	2 mL
Alkalinity, maximum of 0.1N HCL to neutralize 200 mL of water; CMM 870: WTP C-001.....	15 mL
Maximum sulphate (SO <sub>4</sub> ); CMM 870: WTP C-001.....	0.05 percent
Maximum chloride; CMM 870: WTP C-001.....	0.10 percent
Maximum total solids; CMM 870: WTP C-001	
Organic.....	0.04 percent
Inorganic.....	0.15 percent

**501.3.2.4.2 Air Entrainment**

*Replace paragraph two with the following effective with the November 2021 letting:*

(2) Test fresh concrete air content according to AASHTO T152 or AASHTO TP118 at the contract-required frequency and as the engineer directs. Test concrete placed by pumping or belting at the point of discharge from the pump line or belt.

**501.3.7.1 Slump**

*Replace paragraph one with the following effective with the November 2021 letting:*

- (1) Use a 1-inch to 4-inch slump for concrete used in structures or placed in forms, except as follows:
- Do not exceed a slump of 2 inches for grade E concrete.
  - Increase slump as specified in 502.3.5.3 for concrete placed underwater.
  - If BTS approves a concrete mixture using a superplasticizer, the contractor may increase slump for that mixture to a maximum of 9 inches without exceeding the maximum mix water allowed for that grade.

**531.5 Payment**

*Replace paragraph two with the following effective with the November 2021 letting:*

(2) Payment for Concrete Masonry Ancillary Structures Type NS is full compensation for providing concrete for non-standard sign structure foundations; and for anchor rod assemblies. The department will pay separately for excavating and backfilling drilled shafts under the Drilling Shafts bid items.

*Replace paragraph five with the following effective with the November 2021 letting:*

(5) Payment for the Foundation bid items is full compensation for providing concrete foundations; for anchor rod assemblies; for reinforcing steel; and for embedded conduit and electrical components. The department will pay separately for excavating and backfilling drilled shafts under the Drilling Shafts bid items.

**642.2.2.1 General**

*Replace paragraph one with the following effective with the November 2021 letting:*

(1) Provide each field office with two rooms, separated by an interior door with a padlock. Ensure that each room has a separate exterior door and its own air conditioner. Locate the office where a quality internet connection can be achieved. Ensure quality cell phone reception is achievable inside the field office.

**701.3.1 General**

*Replace table 701-1 with the following effective with the November 2021 letting:*

**TABLE 701-1 TESTING AND CERTIFICATION STANDARDS**

TEST	TEST STANDARD	MINIMUM REQUIRED CERTIFICATION (any one of the certifications listed for each test)
Random Sampling	CMM 830.9.2	Transportation Materials Sampling Technician (TMS) TMS Assistant Certified Technician (ACT-TMS) Aggregate Technician I (AGGTEC-I) AGGTEC-I Assistant Certified Technician (ACT-AGG) PCC Technician I (PCCTEC-I) PCCTEC-I Assistant Certified Technician (ACT-PCC) Grading Technician I (GRADINGTEC-I) Grading Assistant Certified Technician (ACT-GRADING)
Sampling Aggregates	AASHTO T2 <sup>[1]</sup> <sup>[4]</sup>	TMS, ACT-TMS, AGGTEC-1, ACT-AGG
Percent passing the No. 200 sieve	AASHTO T11 <sup>[1]</sup>	AGGTEC-I, ACT-AGG
Fine & coarse aggregate gradation	AASHTO T27 <sup>[1]</sup>	
Aggregate moisture content	AASHTO T255 <sup>[1]</sup>	
Fractured faces	ASTM D5821 <sup>[1]</sup>	
Liquid limit	AASHTO T89	
Plasticity index	AASHTO T90 <sup>[3]</sup>	Aggregate Testing for Transportation Systems (ATTS) GRADINGTEC-I, or ACT-GRADING
Sampling freshly mixed concrete	AASHTO R60	PCCTEC-1 ACT-PCC
Air content of fresh concrete	AASHTO T152 <sup>[2]</sup> AASHTO TP118 <sup>[5]</sup>	
Air void system of fresh concrete	AASHTO TP118 <sup>[5]</sup>	
Concrete slump	AASHTO T119 <sup>[2]</sup>	
Concrete temperature	ASTM C1064	
Making and curing concrete specimens	AASHTO T23	
Moist curing for concrete specimens	AASHTO M201	
Concrete compressive strength	AASHTO T22	
Concrete flexural strength	AASHTO T97	
Concrete surface resistivity <sup>[2]</sup>	AASHTO T358	
Voids in aggregate	AASHTO T19	Concrete Strength Tester (CST) CST Assistant Certified Technician (ACT-CST)
Profiling	—	PCCTEC-II PROFILER

<sup>[1]</sup> As modified in CMM 860.

<sup>[2]</sup> As modified in CMM 870.

<sup>[3]</sup> A plasticity check, if required under individual QMP specifications, may be performed by an AGGTEC-I in addition to the certifications listed for liquid limit and plasticity index tests.

<sup>[4]</sup> Plant personnel may operate equipment to obtain samples under the direct observation of a TMS or higher.

<sup>[5]</sup> Consolidate by rodding.

## 710.2 Small Quantities

*Replace the entire text with the following effective with the November 2021 letting:*

- (1) The department defines small quantities as follows:
  - As specified in 715.1.1.2 for class I concrete.
  - Less than 50 cubic yards of class II ancillary concrete placed under a single bid item.
- (2) For contracts with only small quantities of material subject to testing, modify the requirements of 710 as follows:
  1. The contractor may submit an abbreviated quality control plan as allowed in 701.1.2.3.
  2. Provide one of the following for aggregate process control:
    - Documented previous testing dated within 120 calendar days. Provide gradation test results to the engineer before placing material.
    - Non-random start-up gradation testing.

## 710.4 Concrete Mixes

*Replace paragraph two with the following effective with the November 2021 letting:*

- (2) At least 7 business days before producing concrete, document that materials conform to 501 unless the engineer allows or individual QMP specifications provide otherwise. Include the following:

1. For mixes: quantities per cubic yard expressed as SSD weights and net water, water to cementitious material ratio, air content, and SAM number.
2. For cementitious materials and admixtures: type, brand, and source.
3. For aggregates: absorption, SSD bulk specific gravity, wear, soundness, freeze thaw test results if required, and air correction factor. Also include aggregate production records dated within 2 years if using those results in the design. Submit component aggregate gradations, aggregate proportions, and target combined blended aggregate gradations using the following:
  - DT2220 for combined aggregate gradations.
  - DT2221 for optimized aggregate gradations.
4. For optimized concrete mixtures:
  - Complete the worksheets within DT2221 according to the directions.
  - Ensure the optimized aggregate gradations and the optimized mix design conform to WisDOT specifications and pass the built-in tests within DT2221.
  - Verify slip-form mixture workability according to AASHTO TP137 and conformance to specifications through required trial batching.
  - Submit the completed DT2221 to the engineer electronically. Include the trial batch test results with the mix design submittal.

Replace paragraph four with the following effective with the November 2021 letting:

- (4) Prepare and submit modifications to a concrete mix to the engineer for approval 3 business days before using that modified mix. Modifications requiring the engineer's approval include changes in:
  1. Source of any material. For paving and barrier mixes, a source change for fly ash of the same class does not constitute a mix design change.
  2. Quantities of cementitious materials.
  3. Addition or deletion of admixtures. Minor admixture dosage adjustments required to maintain air content or slump do not require engineer review or approval.

### 710.5.5 Strength

Replace paragraph one with the following effective with the November 2021 letting:

- (1) Cast all 6" x 12" cylinders or all 6" x 6" x 21" beams in a set from the same sample. Do not cast more than one set of specimens from a single truckload of concrete. Mark each specimen to identify the lot and subplot or location on the project it represents.

### 710.5.6 Aggregate Testing

Retitle and replace the entire text with the following effective with the November 2021 letting:

#### 710.5.6 Aggregate Testing During Concrete Production

##### 710.5.6.1 General

- (1) The department will accept gradation based on the results of department-performed acceptance testing.
- (2) The department and contractor will obtain samples using the same method. When belt sampling, contractor personnel shall obtain samples for the department under the direct observation of the department personnel. Contractor will define sampling method in the QMP or abbreviated QMP.

##### 710.5.6.2 Contractor Control Charts

###### 710.5.6.2.1 General

- (1) Test aggregate gradations during concrete production except as allowed for small quantities under 710.2. Required contractor testing will be performed using non-random samples.
- (2) Sample aggregates from either the conveyor belt or from the working face of the stockpiles.
- (3) Sample aggregates within 2 business days before placement for each mix design. Include this gradation on the control charts.
- (4) Report gradation test results and provide control charts to the engineer within 1 business day of obtaining the sample. Submit results to the engineer and electronically into MRS as specified in 701.1.2.7.
- (5) Conduct aggregate testing at the minimum frequency shown based on the anticipated daily cumulative plant production for each mix design. The contractor's concrete production tests can be used for the same mix design on multiple contracts.

#### TABLE 710-1 CONTRACTOR GRADATION TESTING FREQUENCY - CLASS I



DAILY PLANT PRODUCTION RATE FOR WisDOT WORK	MINIMUM FREQUENCY
Gradation Report Before Placement	
1000 cubic yards or less	one test per day
more than 1000 cubic yards	two tests per day

**TABLE 710-2 CONTRACTOR GRADATION TESTING FREQUENCY - CLASS II**

MINIMUM FREQUENCY
Gradation Report Before Placement
One test per calendar week of production

**710.5.6.2.2 Optimized Aggregate Gradation Control Charts**

- (1) Determine the complete gradation using a washed analysis for both fine and coarse aggregates. Report results for the following:
  - 1 1/2", 1", 3/4", 1/2", 3/8", #4, #8, #16, #30, #50, #100, and #200 sieves.
  - Sum of volumetric percentages retained on No. 8, No. 16, and No. 30 sieves.
  - Sum of volumetric percentages retained on No. 30, No. 50, No. 100, and No. 200 sieves.
- (2) Calculate blended aggregate gradations using the mix design batch percentages for the component aggregates. Ensure the blended aggregate gradation conforms to the volumetric percent retained of the optimized aggregate gradation limits specified in table 501-4.
- (3) Throughout the contract, construct a 4-point running average of the volumetric percent retained for each sieve to determine if the blended aggregate gradation is within the tarantula curve limits specified in table 501-4.

**710.5.6.2.3 Combined Aggregate Gradation Control Charts**

- (1) Determine the complete gradation using a washed analysis for both fine and coarse aggregates. Report results for the 1 1/2", 1", 3/4", 1/2", 3/8", #4, #8, #16, #30, #50, #100, and #200 sieves.
- (2) Calculate blended aggregate gradations using the mix design batch percentages for the component aggregates. Ensure the blended aggregate gradation conforms to the percent passing by weight requirements of the combined aggregate gradation limits specified in table 501-4.
- (3) Throughout the contract, construct a 4-point running average of the percent passing by weight for each sieve to determine if the blended aggregate gradation is within the combined aggregate gradation limits specified in table 501-4.

**710.5.6.3 Department Acceptance Testing**

- (1) Department testing frequency is based on the quantity of each mix design placed under each individual WisDOT contract.
- (2) The department will split each sample, test for acceptance, and retain the remainder for a minimum of 10 calendar days.
- (3) The department will obtain the sample and deliver to regional testing lab in the same day. Department will report gradation test results to the contractor within 1 business day of being delivered to the lab. Department and contractor can agree to an alternative test result reporting timeframe; alternative timeframe is required to be documented in the QMP.
- (4) Additional samples may be taken at the engineer's discretion due to change in condition.

**TABLE 710-3 DEPARTMENT GRADATION TESTING FREQUENCY**

CONCRETE CLASSIFICATION	MINIMUM DEPARTMENT FREQUENCY
Class I: Pavement	1 test per placement day for first 5 days of placement. If all samples are passing, reduced frequency is applied.
	Reduced frequency: 1 test per calendar week of placement
Class I: Structures	1 test per 250 CY placed <ul style="list-style-type: none"> <li>- Minimum of 1 test per substructure</li> <li>- Minimum of 1 test per superstructure</li> </ul>



Class I: Cast-in-Place Barrier	1 test per 500 CY placed
Class II	No minimum testing

### 710.5.7 Corrective Action

*Replace the entire text with the following effective with the November 2021 letting:*

#### 710.5.7.1 Optimized Aggregate Gradations

- (1) If the contractor's 4-point running average or a department test result of the volumetric percent retained exceeds the tarantula curve limits by less than or equal to 1.0 percent on a single sieve size, do the following:
  1. Notify the other party immediately.
  2. Perform corrective action documented in the QC plan or as the engineer approves.
  3. Document and provide corrective action results to the engineer as soon as they are available.
  4. Department will conduct two tests within the next business day after corrective action is complete.
  5. If blended aggregate gradations are within the tarantula curve limits by the second department test:
    - Continue with concrete production.
    - Contractor will include a break in the 4-point running average.
    - For Class I: Pavements, department will discontinue reduced frequency testing and will test at a frequency of 1 test per placement day. Once 5 consecutive samples are passing at the 1 test per placement day frequency, the reduced frequency testing will be reapplied.
  6. If blended aggregate gradations are not within the tarantula curve limits by the second department test:
    - Provide a new mix design with an increased cementitious content.
    - If the mix design already has a cementitious content of 565 or more pounds per cubic yard, provide a new mix design.
    - If the contract requires optimized aggregate gradations under 501.2.7.4.2.1(2), stop concrete production and submit a new mix design.
- (2) If the contractor's 4-point running average or a department test result of the volumetric percent retained exceeds the tarantula curve limits by more than 1.0 percent on one or more sieves, stop concrete production and submit a new mix design.
- (3) Department and contractor will sample and test aggregate of the new mix design at the frequency defined in 710.5.6.1.

#### 710.5.7.2 Combined Aggregate Gradations

- (1) If the contractor's 4-point running average or a department test result of the percent passing by weight exceeds the combined aggregate gradation limits by less than or equal to 1.0 percent on a single sieve size, do the following:
  1. Notify the other party immediately.
  2. Perform corrective action documented in the QC plan or as the engineer approves.
  3. Document and provide corrective action results to the engineer as soon as they are available.
  4. Department will conduct two tests within the next business day after corrective action is complete.
  5. If blended aggregate gradations are within the combined aggregate gradation limits by the second department test:
    - Continue with concrete production.
    - Contractor will include a break in the 4-point running average.
    - For Class I: Pavements, department will discontinue reduced frequency testing and will test at a frequency of 1 test per placement day. Once 5 consecutive samples are passing at the 1 test per placement day frequency, the reduced frequency testing will be reapplied.
  6. If blended aggregate gradations are not within the combined aggregate gradation limits by the second department test, stop concrete production and submit a new mix design.
- (2) If the contractor's 4-point running average or a department test result of the percent passing by weight exceeds the combined aggregate gradation limits by more than 1.0 percent on one or more sieves, stop concrete production and submit a new mix design.
- (3) Department and contractor will sample and test aggregate of the new mix design at the frequency defined in 710.5.6.1.

**715.3.1.1 General**

Replace paragraphs three and four with the following effective with the November 2021 letting:

- (3) Cast a set of 3 additional 6"x12" cylinders and test the concrete surface resistivity according to AASHTO T358. Perform this testing at least once per lot if total contract quantities are greater than or equal to the following:

- 20,000 square yards for pavements.
- 5,000 linear feet for barriers.
- 500 cubic yards for structure concrete.

Submit the resistivity to the nearest tenth into MRS for information only. Resistivity testing is not required for the following:

- Lot with less than 3 sublots.
  - Concrete items classified as ancillary.
  - Concrete placed under the following bid items:
    - Concrete Pavement Approach Slab
    - Concrete Masonry Culverts
    - Concrete Masonry Retaining Walls
- (4) Test the air void system at least once per lot and enter the SAM number in MRS for information only. SAM testing is not required for the following:
- For lots with less than 3 sublots.
  - High early strength (HES) concrete.
  - Special high early strength (SHES) concrete.
  - Concrete placed under the following bid items:
    - Concrete Pavement Approach Slab
    - Concrete Masonry Culverts
    - Concrete Masonry Retaining Walls
    - Steel Grid Floor Concrete Filled
    - Crash Cushions Permanent
    - Crash Cushions Permanent Low Maintenance
    - Crash Cushions Temporary

**715.3.1.2.3 Lots by Cubic Yard**

Replace the entire text with the following effective with the November 2021 letting:

- (1) Define standard lots and sublots conforming to the following:

**TABLE 715-1 CLASS I - LOT AND SUBLOT SIZES**

CONCRETE CLASSIFICATION	LOT SIZE	SUBLOT SIZE	NUMBER OF SUBLOTS PER LOT
Class I: Pavement	1250 cubic yards	250 cubic yards	5
Class I: Structures	250 cubic yards	50 cubic yards	5
Class I: Cast-in-Place Barrier	500 cubic yards	100 cubic yards	5

- (2) The contractor may include sublots less than or equal to 25 percent of the standard volume in the previous subplot. For partial sublots exceeding 25 percent of the standard volume, notify the engineer who will direct additional testing to represent that partial subplot.
- (3) An undersized lot is eligible for incentive payment under 715.5 if the lot has 3 or more sublots for that lot.

**715.3.2 Strength Evaluation**

Replace the entire text with the following effective with the November 2021 letting:

**715.3.2.1 General**

- (1) The department will make pay adjustments for strength on a lot-by-lot basis using the compressive strength of contractor QC cylinders or the flexural strength of contractor QC beams.

- 
- (2) Randomly select 2 QC specimens to test at 28 days for percent within limits (PWL). Compare the strengths of the 2 randomly selected QC specimens and determine the 28-day subplot average strength as follows:
- If the lower strength divided by the higher strength is 0.9 or more, average the 2 QC specimens.
  - If the lower strength divided by the higher strength is less than 0.9, break one additional specimen and average the 2 higher strength specimens.

### **715.3.2.2 Removal and Replacement**

#### **715.3.2.2.1 Pavement**

- (1) If a subplot strength is less than 2500 psi in compressive strength or 500 psi in flexural strength, the department may direct the contractor to core that subplot to determine its structural adequacy and whether to direct removal.
- (2) If the engineer directs coring, obtain three cores from the subplot in question. Have an HTCP-certified PCC technician I perform or observe core sampling according to AASHTO T24.
- (3) Have an independent consultant test cores according to AASHTO T24.
- (4) The department will assess concrete for removal and replacement based on a subplot-by-subplot analysis of core strength. Perform coring and testing, fill core holes with an engineer-approved non-shrink grout or concrete, and provide traffic control during coring.
- (5) The subplot pavement is conforming if the compressive strengths of all cores from the subplot are 2500 psi or greater.
- (6) The subplot pavement is nonconforming if the compressive strengths of any core from the subplot is less than 2500 psi. The department may direct removal and replacement or otherwise determine the final disposition of nonconforming material as specified in 106.5.

#### **715.3.2.2.2 Structures and Cast-in-Place Barrier**

- (1) The department will evaluate the subplot for possible removal and replacement if the 28-day subplot average compressive strength is lower than  $f'c$  minus 500 psi. The value of  $f'c$  is the design stress the plans show. The department may assess further strength price reductions or require removal and replacement only after coring the subplot.
- (2) The engineer may initially evaluate the subplot strength using a non-destructive method. Based on the results of non-destructive testing, the department may accept the subplot at the previously determined pay for the lot, or direct the contractor to core the subplot.
- (3) If the engineer directs coring, obtain three cores from the subplot in question. Have an HTCP-certified PCC technician I perform or observe core sampling according to AASHTO T24. Determine core locations, subject to the engineer's approval, that do not interfere with structural steel.
- (4) Have an independent consultant test cores according to AASHTO T24.
- (5) The department will assess concrete for removal and replacement based on a subplot-by-subplot analysis of core strength. Perform coring and testing, fill core holes with an engineer-approved non-shrink grout or concrete, and provide traffic control during coring.
- (6) If the 3-core average is greater than or equal to 85 percent of  $f'c$ , and no individual core is less than 75 percent of  $f'c$ , the engineer will accept the subplot at the previously determined pay for the lot. If the 3-core average is less than 85 percent of  $f'c$ , or an individual core is less than 75 percent of  $f'c$ , the engineer may require the contractor to remove and replace the subplot. The department may direct removal and replacement or otherwise determine the final disposition of nonconforming material as specified in 106.5.

---

### **715.3.3 Aggregate**

*Replace the entire text with the following effective with the November 2021 letting:*

#### **715.3.3.1 General**

- (1) Except as allowed for small quantities in 710.2, test aggregate conforming to 710.5.6.

#### **715.3.3.2 Structures**

- (1) In addition to the aggregate testing required under 710.5.6, determine the fine and coarse aggregate moisture content for each sample.
- (2) Calculate target batch weights for each mix when production of that mix begins. Whenever the moisture content of the fine or coarse aggregate changes by more than 0.5 percent, adjust the batch weights to maintain the design w/cm ratio.

**715.5 Payment**

*Replace the entire text with the following effective with the November 2021 letting:*

**715.5.1 General**

- (1) The department will pay incentive for compressive strength under the following bid items:

<u>ITEM NUMBER</u>	<u>DESCRIPTION</u>	<u>UNIT</u>
715.0502	Incentive Strength Concrete Structures	DOL
715.0603	Incentive Strength Concrete Barrier	DOL
715.0715	Incentive Flexural Strength Concrete Pavement	DOL
715.0720	Incentive Compressive Strength Concrete Pavement	DOL

- (2) Incentive payment may be more or less than the amount the schedule of items shows.
- (3) The department will administer disincentives for strength under the Disincentive Strength Concrete Structures, Disincentive Strength Concrete Barrier, Disincentive Flexural Strength Concrete Pavement, and Disincentive Compressive Strength Concrete Pavement, administrative items.
- (4) The pay factor that is calculated from the equations in 715.5.2(2) and 715.5.3(2) will be applied to the unit costs listed below:
- Pavement: \$45 per SY.
  - Structure: \$635 per CY.
  - Cast-in-place barrier: \$75 per LF.
- (5) 28-day strength average for a lot is the average of the individual subplot strengths within the given lot.
- (6) The department will not pay a strength incentive for concrete that is nonconforming in another specified property, for ancillary concrete accepted based on tests of class I concrete, or for high early strength concrete unless placed in pavement gaps as allowed under 715.3.1.2.2.
- (7) Submit test results to the department electronically using MRS software. The department will validate contractor data before determining pay adjustments.
- (8) All coring and testing costs under 715.3.2.2 including filling core holes and providing traffic control during coring are incidental to the contract.

**715.5.2 Compressive Strength**

- (1) The department will measure PWL relative to strength lower specification limits as follows:
- Compressive strength of 3700 psi for pavements.
  - Compressive strength of 4000 psi for structures and cast-in-place barrier.

- (2) The department will adjust pay for each lot using equation "Comp2022" as follows:

Percent within Limits (PWL)	Pay Factor (%)
>= 90 to 100	$(1/5 \times \text{PWL}) + 82$
>= 85 to < 90	100
>= 50 to < 85	$(5/7 \times \text{PWL}) + (275/7)$
< 50	50 <sup>[1]</sup>

<sup>[1]</sup> Any material resulting in a lot PWL value less than 50 will be evaluated according to 715.3.2. In the event the material remains in place, it will be paid at 50 percent of the contract unit price of the concrete bid item.

- (3) The department will not pay incentive if the lot standard deviation is greater than the following:
- 400 psi for pavement.
  - 350 psi for structure and cast-in-place barrier
- (4) For lots with less than 3 sublots, there is no incentive but the department will reduce pay by 50 percent of the contract unit price for sublots with an average compressive strength below the following:
- 3700 psi for pavements.
  - 4000 psi for structures and cast-in-place barrier.

**715.5.3 Flexural Strength**

- (1) The department will measure PWL relative to strength lower specification limits as follows:
- Flexural strength of 650 psi for pavements.

- (2) The department will adjust pay for each lot using equation "Flex2022" as follows:

Percent within Limits (PWL)	Pay Factor (%)
>= 90 to 100	$(2/5 \times \text{PWL}) + 64$
>= 85 to < 90	100

>= 50 to < 85  
< 50

$(5/7 \times \text{PWL}) + (275/7)$   
 $50^{[1]}$

<sup>[1]</sup> Material resulting in a lot PWL value less than 50 will be evaluated according to 715.3.2. In the event the material remains in place, it will be paid at 50 percent of the contract unit price of the concrete bid item.

- (3) The department will not pay incentive if the lot standard deviation is greater than 60 psi.
  - (4) For lots with less than 3 sublots, there is no incentive but the department will reduce pay by 50 percent of the contract unit price for sublots with an average flexural strength below 650 psi.
-

## ERRATA

**460.2.2.3 Aggregate Gradation Master Range****Correct errata by adding US Standard equivalent sieve sizes.**

- (1) Ensure that the aggregate blend, including recycled material and mineral filler, conforms to the gradation requirements in table 460-1. The values listed are design limits; production values may exceed those limits.

**TABLE 460-1 AGGREGATE GRADATION MASTER RANGE AND VMA REQUIREMENTS**

SIEVE	PERCENT PASSING DESIGNATED SIEVES							
	NOMINAL SIZE							
	No. 1 (37.5 mm) (1 1/2 inch)	No. 2 (25.0 mm) (1 inch)	No.3 (19.0 mm) (3/4 inch)	No. 4 (12.5 mm) (1/2 inch)	No. 5 (9.5 mm) (3/8 inch)	No. 6 (4.75 mm) (3/16 inch)	SMA No. 4 (12.5 mm) (1/2 inch)	SMA No. 5 (9.5 mm) (3/8 inch)
50.0-mm (2-inch)	100							
37.5-mm (1 1/2-inch)	90 - 100	100						
25.0-mm (1-inch)	90 max	90 - 100	100					
19.0-mm (3/4-inch)	—	90 max	90 - 100	100			100	
12.5-mm (1/2-inch)	—	—	90 max	90 - 100	100		90 - 97	100
9.5-mm (3/8-inch)	—	—	—	90 max	90 - 100	100	58 - 80	90 - 100
4.75-mm (No. 4)	—	—	—	—	90 max	90 - 100	25 - 35	35 - 45
2.36-mm (No. 8)	15 - 41	19 - 45	23 - 49	28 - 58	32 - 67	90 max	15 - 25	18 - 28
1.18-mm (No. 16)	—	—	—	—	—	30 - 55	—	—
0.60-mm (No. 30)	—	—	—	—	—	—	18 max	18 max
0.075-mm (No. 200)	0 - 6.0	1.0 - 7.0	2.0 - 8.0	2.0 - 10.0	2.0 - 10.0	6.0 - 13.0	8.0 - 11.0	8.0 - 12.0
% VMA	11.0 min	12.0 min	13.0 min	14.0 min <sup>[1]</sup>	15.0 min <sup>[2]</sup>	16.0 - 17.5	16.0 min	17.0 min

<sup>[1]</sup> 14.5 for LT and MT mixes.

<sup>[2]</sup> 15.5 for LT and MT mixes.

**715.5.1 General**Correct the bid item number for Incentive Compressive Strength Concrete Pavement.

- (1) The department will pay incentive for compressive strength under the following bid items:

<u>ITEM NUMBER</u>	<u>DESCRIPTION</u>	<u>UNIT</u>
715.0502	Incentive Strength Concrete Structures	DOL
715.0603	Incentive Strength Concrete Barrier	DOL
715.0715	Incentive Flexural Strength Concrete Pavement	DOL
715.0720	Incentive Compressive Strength Concrete Pavement	DOL

**ADDITIONAL SPECIAL PROVISION 7**

- A. Reporting 1<sup>st</sup> Tier and DBE Payments During Construction
1. Comply with reporting requirements specified in the department's Civil Rights Compliance, Contractor's User Manual, Sublets and Payments.
  2. Report payments to all DBE firms within 10 calendar days of receipt of a progress payment by the department or a contractor for work performed, materials furnished, or materials stockpiled by a DBE firm. Report the payment as specified in A(1) for all work satisfactorily performed and for all materials furnished or stockpiled.
  3. Report payments to all first tier subcontractor relationships within 10 calendar days of receipt of a progress payment by the department for work performed. Report the payment as specified in A(1) for all work satisfactorily performed.
  4. All tiers shall report payments as necessary to comply with the DBE payment requirement as specified in A(2).
  5. Require all first tier relationships, DBE firms and all other tier relationships necessary to comply with the DBE payment requirement in receipt of a progress payment by contractor to acknowledge receipt of payment as specified in A(1), (2), (3) and (4).
  6. All agreements made by a contractor shall include the provisions in A(1), (2), (3), (4) and (5), and shall be binding on all first tier subcontractor relationships and all contractors and subcontractors utilizing DBE firms on the project.
- B. Costs for conforming to this special provision are incidental to the contract.

NOTE: CRCS Prime Contractor payment is currently not automated and will need to be manually loaded into the Civil Rights Compliance System. Copies of prime contractor payments received (check or ACH) will have to be forwarded to [paul.ndon@dot.wi.gov](mailto:paul.ndon@dot.wi.gov) within 5 days of payment receipt to be logged manually.

\*\*\*Additionally, for information on Subcontractor Sublet assignments, Subcontractor Payments and Payment Tracking, please refer to the CRCS Payment and Sublets manual at:

<https://wisconsin.gov/Documents/doing-bus/civil-rights/labornwage/crcs-payments-sublets-manual.pdf>

## **ADDITIONAL SPECIAL PROVISION 9**

### **Electronic Certified Payroll or Labor Data Submittal**

(1) Use the department's Civil Rights Compliance System (CRCS) to electronically submit certified payroll reports for contracts with federal funds and labor data for contracts with state funds only. Details are available online through the department's highway construction contractor information (HCCI) site on the Labor, Wages, and EEO Information page at:

<https://wisconsindot.gov/Pages/doing-bus/civil-rights/labornwage/default.aspx>

(2) Ensure that all tiers of subcontractors, including all trucking firms, either submit their weekly certified payroll reports (contracts with federal funds) or labor data (contracts with state funds only) electronically through CRCS. These payrolls or labor data are due within seven calendar days following the close of the payroll period. Every firm providing physical labor towards completing the project is a subcontractor under this special provision.

(3) Upon receipt of contract execution, promptly make all affected firms aware of the requirements under this special provision and arrange for them to receive CRCS training as they are about to begin their submittals. The department will provide training either in a classroom setting at one of our regional offices or by telephone. Contact Paul Ndon at (414) 438-4584 to schedule the training.

(4) The department will reject all paper submittals for information required under this special provision. All costs for conforming to this special provision are incidental to the contract.

(5) Firms wishing to export payroll/labor data from their computer system into CRCS should have their payroll coordinator contact Paul Ndon at [paul.ndon@dot.wi.gov](mailto:paul.ndon@dot.wi.gov). Not every contractor's payroll system is capable of producing export files. For details, see Section 4.8 CPR Auto Submit (Data Mapping) on pages 49-50; 66-71 of the CRCS Payroll Manual at:

<https://wisconsindot.gov/Documents/doing-bus/civil-rights/labornwage/crcs-payroll-manual.pdf>



**REQUIRED CONTRACT PROVISIONS  
FEDERAL-AID CONSTRUCTION CONTRACTS**

- I. General
- II. Nondiscrimination
- III. Nonsegregated Facilities
- IV. Davis-Bacon and Related Act Provisions
- V. Contract Work Hours and Safety Standards Act Provisions
- VI. Subletting or Assigning the Contract
- VII. Safety: Accident Prevention
- VIII. False Statements Concerning Highway Projects
- IX. Implementation of Clean Air Act and Federal Water Pollution Control Act
- X. Compliance with Governmentwide Suspension and Debarment Requirements
- XI. Certification Regarding Use of Contract Funds for Lobbying

**ATTACHMENTS**

A. Employment and Materials Preference for Appalachian Development Highway System or Appalachian Local Access Road Contracts (included in Appalachian contracts only)

**I. GENERAL**

1. Form FHWA-1273 must be physically incorporated in each construction contract funded under Title 23 (excluding emergency contracts solely intended for debris removal). The contractor (or subcontractor) must insert this form in each subcontract and further require its inclusion in all lower tier subcontracts (excluding purchase orders, rental agreements and other agreements for supplies or services).

The applicable requirements of Form FHWA-1273 are incorporated by reference for work done under any purchase order, rental agreement or agreement for other services. The prime contractor shall be responsible for compliance by any subcontractor, lower-tier subcontractor or service provider.

Form FHWA-1273 must be included in all Federal-aid design-build contracts, in all subcontracts and in lower tier subcontracts (excluding subcontracts for design services, purchase orders, rental agreements and other agreements for supplies or services). The design-builder shall be responsible for compliance by any subcontractor, lower-tier subcontractor or service provider.

Contracting agencies may reference Form FHWA-1273 in bid proposal or request for proposal documents, however, the Form FHWA-1273 must be physically incorporated (not referenced) in all contracts, subcontracts and lower-tier subcontracts (excluding purchase orders, rental agreements and other agreements for supplies or services related to a construction contract).

2. Subject to the applicability criteria noted in the following sections, these contract provisions shall apply to all work performed on the contract by the contractor's own organization and with the assistance of workers under the contractor's immediate superintendence and to all work performed on the contract by piecework, station work, or by subcontract.

3. A breach of any of the stipulations contained in these Required Contract Provisions may be sufficient grounds for withholding of progress payments, withholding of final payment, termination of the contract, suspension / debarment or any other action determined to be appropriate by the contracting agency and FHWA.

4. Selection of Labor: During the performance of this contract, the contractor shall not use convict labor for any purpose within the limits of a construction project on a Federal-aid highway unless it is labor performed by convicts who are on parole, supervised release, or probation. The term Federal-aid highway does not include roadways functionally classified as local roads or rural minor collectors.

**II. NONDISCRIMINATION**

The provisions of this section related to 23 CFR Part 230 are applicable to all Federal-aid construction contracts and to all related construction subcontracts of \$10,000 or more. The provisions of 23 CFR Part 230 are not applicable to material supply, engineering, or architectural service contracts.

In addition, the contractor and all subcontractors must comply with the following policies: Executive Order 11246, 41 CFR 60, 29 CFR 1625-1627, Title 23 USC Section 140, the Rehabilitation Act of 1973, as amended (29 USC 794), Title VI of the Civil Rights Act of 1964, as amended, and related regulations including 49 CFR Parts 21, 26 and 27; and 23 CFR Parts 200, 230, and 633.

The contractor and all subcontractors must comply with: the requirements of the Equal Opportunity Clause in 41 CFR 60-1.4(b) and, for all construction contracts exceeding \$10,000, the Standard Federal Equal Employment Opportunity Construction Contract Specifications in 41 CFR 60-4.3.

Note: The U.S. Department of Labor has exclusive authority to determine compliance with Executive Order 11246 and the policies of the Secretary of Labor including 41 CFR 60, and 29 CFR 1625-1627. The contracting agency and the FHWA have the authority and the responsibility to ensure compliance with Title 23 USC Section 140, the Rehabilitation Act of 1973, as amended (29 USC 794), and Title VI of the Civil Rights Act of 1964, as amended, and related regulations including 49 CFR Parts 21, 26 and 27; and 23 CFR Parts 200, 230, and 633.

The following provision is adopted from 23 CFR 230, Appendix A, with appropriate revisions to conform to the U.S. Department of Labor (US DOL) and FHWA requirements.

**1. Equal Employment Opportunity:** Equal employment opportunity (EEO) requirements not to discriminate and to take affirmative action to assure equal opportunity as set forth under laws, executive orders, rules, regulations (28 CFR 35, 29 CFR 1630, 29 CFR 1625-1627, 41 CFR 60 and 49 CFR 27) and orders of the Secretary of Labor as modified by the provisions prescribed herein, and imposed pursuant to 23 U.S.C. 140 shall constitute the EEO and specific affirmative action standards for the contractor's project activities under

this contract. The provisions of the Americans with Disabilities Act of 1990 (42 U.S.C. 12101 et seq.) set forth under 28 CFR 35 and 29 CFR 1630 are incorporated by reference in this contract. In the execution of this contract, the contractor agrees to comply with the following minimum specific requirement activities of EEO:

a. The contractor will work with the contracting agency and the Federal Government to ensure that it has made every good faith effort to provide equal opportunity with respect to all of its terms and conditions of employment and in their review of activities under the contract.

b. The contractor will accept as its operating policy the following statement:

"It is the policy of this Company to assure that applicants are employed, and that employees are treated during employment, without regard to their race, religion, sex, color, national origin, age or disability. Such action shall include: employment, upgrading, demotion, or transfer; recruitment or recruitment advertising; layoff or termination; rates of pay or other forms of compensation; and selection for training, including apprenticeship, pre-apprenticeship, and/or on-the-job training."

**2. EEO Officer:** The contractor will designate and make known to the contracting officers an EEO Officer who will have the responsibility for and must be capable of effectively administering and promoting an active EEO program and who must be assigned adequate authority and responsibility to do so.

**3. Dissemination of Policy:** All members of the contractor's staff who are authorized to hire, supervise, promote, and discharge employees, or who recommend such action, or who are substantially involved in such action, will be made fully cognizant of, and will implement, the contractor's EEO policy and contractual responsibilities to provide EEO in each grade and classification of employment. To ensure that the above agreement will be met, the following actions will be taken as a minimum:

a. Periodic meetings of supervisory and personnel office employees will be conducted before the start of work and then not less often than once every six months, at which time the contractor's EEO policy and its implementation will be reviewed and explained. The meetings will be conducted by the EEO Officer.

b. All new supervisory or personnel office employees will be given a thorough indoctrination by the EEO Officer, covering all major aspects of the contractor's EEO obligations within thirty days following their reporting for duty with the contractor.

c. All personnel who are engaged in direct recruitment for the project will be instructed by the EEO Officer in the contractor's procedures for locating and hiring minorities and women.

d. Notices and posters setting forth the contractor's EEO policy will be placed in areas readily accessible to employees, applicants for employment and potential employees.

e. The contractor's EEO policy and the procedures to implement such policy will be brought to the attention of employees by means of meetings, employee handbooks, or other appropriate means.

**4. Recruitment:** When advertising for employees, the contractor will include in all advertisements for employees the notation: "An Equal Opportunity Employer." All such advertisements will be placed in publications having a large circulation among minorities and women in the area from which the project work force would normally be derived.

a. The contractor will, unless precluded by a valid bargaining agreement, conduct systematic and direct recruitment through public and private employee referral sources likely to yield qualified minorities and women. To meet this requirement, the contractor will identify sources of potential minority group employees, and establish with such identified sources procedures whereby minority and women applicants may be referred to the contractor for employment consideration.

b. In the event the contractor has a valid bargaining agreement providing for exclusive hiring hall referrals, the contractor is expected to observe the provisions of that agreement to the extent that the system meets the contractor's compliance with EEO contract provisions. Where implementation of such an agreement has the effect of discriminating against minorities or women, or obligates the contractor to do the same, such implementation violates Federal nondiscrimination provisions.

c. The contractor will encourage its present employees to refer minorities and women as applicants for employment. Information and procedures with regard to referring such applicants will be discussed with employees.

**5. Personnel Actions:** Wages, working conditions, and employee benefits shall be established and administered, and personnel actions of every type, including hiring, upgrading, promotion, transfer, demotion, layoff, and termination, shall be taken without regard to race, color, religion, sex, national origin, age or disability. The following procedures shall be followed:

a. The contractor will conduct periodic inspections of project sites to insure that working conditions and employee facilities do not indicate discriminatory treatment of project site personnel.

b. The contractor will periodically evaluate the spread of wages paid within each classification to determine any evidence of discriminatory wage practices.

c. The contractor will periodically review selected personnel actions in depth to determine whether there is evidence of discrimination. Where evidence is found, the contractor will promptly take corrective action. If the review indicates that the discrimination may extend beyond the actions reviewed, such corrective action shall include all affected persons.

d. The contractor will promptly investigate all complaints of alleged discrimination made to the contractor in connection with its obligations under this contract, will attempt to resolve such complaints, and will take appropriate corrective action within a reasonable time. If the investigation indicates that the discrimination may affect persons other than the complainant, such corrective action shall include such other persons. Upon completion of each investigation, the contractor will inform every complainant of all of their avenues of appeal.

**6. Training and Promotion:**

a. The contractor will assist in locating, qualifying, and increasing the skills of minorities and women who are

applicants for employment or current employees. Such efforts should be aimed at developing full journey level status employees in the type of trade or job classification involved.

b. Consistent with the contractor's work force requirements and as permissible under Federal and State regulations, the contractor shall make full use of training programs, i.e., apprenticeship, and on-the-job training programs for the geographical area of contract performance. In the event a special provision for training is provided under this contract, this subparagraph will be superseded as indicated in the special provision. The contracting agency may reserve training positions for persons who receive welfare assistance in accordance with 23 U.S.C. 140(a).

c. The contractor will advise employees and applicants for employment of available training programs and entrance requirements for each.

d. The contractor will periodically review the training and promotion potential of employees who are minorities and women and will encourage eligible employees to apply for such training and promotion.

**7. Unions:** If the contractor relies in whole or in part upon unions as a source of employees, the contractor will use good faith efforts to obtain the cooperation of such unions to increase opportunities for minorities and women. Actions by the contractor, either directly or through a contractor's association acting as agent, will include the procedures set forth below:

a. The contractor will use good faith efforts to develop, in cooperation with the unions, joint training programs aimed toward qualifying more minorities and women for membership in the unions and increasing the skills of minorities and women so that they may qualify for higher paying employment.

b. The contractor will use good faith efforts to incorporate an EEO clause into each union agreement to the end that such union will be contractually bound to refer applicants without regard to their race, color, religion, sex, national origin, age or disability.

c. The contractor is to obtain information as to the referral practices and policies of the labor union except that to the extent such information is within the exclusive possession of the labor union and such labor union refuses to furnish such information to the contractor, the contractor shall so certify to the contracting agency and shall set forth what efforts have been made to obtain such information.

d. In the event the union is unable to provide the contractor with a reasonable flow of referrals within the time limit set forth in the collective bargaining agreement, the contractor will, through independent recruitment efforts, fill the employment vacancies without regard to race, color, religion, sex, national origin, age or disability; making full efforts to obtain qualified and/or qualifiable minorities and women. The failure of a union to provide sufficient referrals (even though it is obligated to provide exclusive referrals under the terms of a collective bargaining agreement) does not relieve the contractor from the requirements of this paragraph. In the event the union referral practice prevents the contractor from meeting the obligations pursuant to Executive Order 11246, as amended, and these special provisions, such contractor shall immediately notify the contracting agency.

**8. Reasonable Accommodation for Applicants / Employees with Disabilities:** The contractor must be familiar

with the requirements for and comply with the Americans with Disabilities Act and all rules and regulations established there under. Employers must provide reasonable accommodation in all employment activities unless to do so would cause an undue hardship.

**9. Selection of Subcontractors, Procurement of Materials and Leasing of Equipment:** The contractor shall not discriminate on the grounds of race, color, religion, sex, national origin, age or disability in the selection and retention of subcontractors, including procurement of materials and leases of equipment. The contractor shall take all necessary and reasonable steps to ensure nondiscrimination in the administration of this contract.

a. The contractor shall notify all potential subcontractors and suppliers and lessors of their EEO obligations under this contract.

b. The contractor will use good faith efforts to ensure subcontractor compliance with their EEO obligations.

**10. Assurance Required by 49 CFR 26.13(b):**

a. The requirements of 49 CFR Part 26 and the State DOT's U.S. DOT-approved DBE program are incorporated by reference.

b. The contractor or subcontractor shall not discriminate on the basis of race, color, national origin, or sex in the performance of this contract. The contractor shall carry out applicable requirements of 49 CFR Part 26 in the award and administration of DOT-assisted contracts. Failure by the contractor to carry out these requirements is a material breach of this contract, which may result in the termination of this contract or such other remedy as the contracting agency deems appropriate.

**11. Records and Reports:** The contractor shall keep such records as necessary to document compliance with the EEO requirements. Such records shall be retained for a period of three years following the date of the final payment to the contractor for all contract work and shall be available at reasonable times and places for inspection by authorized representatives of the contracting agency and the FHWA.

a. The records kept by the contractor shall document the following:

(1) The number and work hours of minority and non-minority group members and women employed in each work classification on the project;

(2) The progress and efforts being made in cooperation with unions, when applicable, to increase employment opportunities for minorities and women; and

(3) The progress and efforts being made in locating, hiring, training, qualifying, and upgrading minorities and women;

b. The contractors and subcontractors will submit an annual report to the contracting agency each July for the duration of the project, indicating the number of minority, women, and non-minority group employees currently engaged in each work classification required by the contract work. This information is to be reported on [Form FHWA-1391](#). The staffing data should represent the project work force on board in all or any part of the last payroll period preceding the end of July. If on-the-job training is being required by special provision, the contractor

will be required to collect and report training data. The employment data should reflect the work force on board during all or any part of the last payroll period preceding the end of July.

### III. NONSEGREGATED FACILITIES

This provision is applicable to all Federal-aid construction contracts and to all related construction subcontracts of \$10,000 or more.

The contractor must ensure that facilities provided for employees are provided in such a manner that segregation on the basis of race, color, religion, sex, or national origin cannot result. The contractor may neither require such segregated use by written or oral policies nor tolerate such use by employee custom. The contractor's obligation extends further to ensure that its employees are not assigned to perform their services at any location, under the contractor's control, where the facilities are segregated. The term "facilities" includes waiting rooms, work areas, restaurants and other eating areas, time clocks, restrooms, washrooms, locker rooms, and other storage or dressing areas, parking lots, drinking fountains, recreation or entertainment areas, transportation, and housing provided for employees. The contractor shall provide separate or single-user restrooms and necessary dressing or sleeping areas to assure privacy between sexes.

### IV. DAVIS-BACON AND RELATED ACT PROVISIONS

This section is applicable to all Federal-aid construction projects exceeding \$2,000 and to all related subcontracts and lower-tier subcontracts (regardless of subcontract size). The requirements apply to all projects located within the right-of-way of a roadway that is functionally classified as Federal-aid highway. This excludes roadways functionally classified as local roads or rural minor collectors, which are exempt. Contracting agencies may elect to apply these requirements to other projects.

The following provisions are from the U.S. Department of Labor regulations in 29 CFR 5.5 "Contract provisions and related matters" with minor revisions to conform to the FHWA-1273 format and FHWA program requirements.

#### 1. Minimum wages

a. All laborers and mechanics employed or working upon the site of the work, will be paid unconditionally and not less often than once a week, and without subsequent deduction or rebate on any account (except such payroll deductions as are permitted by regulations issued by the Secretary of Labor under the Copeland Act (29 CFR part 3)), the full amount of wages and bona fide fringe benefits (or cash equivalents thereof) due at time of payment computed at rates not less than those contained in the wage determination of the Secretary of Labor which is attached hereto and made a part hereof, regardless of any contractual relationship which may be alleged to exist between the contractor and such laborers and mechanics.

Contributions made or costs reasonably anticipated for bona fide fringe benefits under section 1(b)(2) of the Davis-Bacon Act on behalf of laborers or mechanics are considered wages paid to such laborers or mechanics, subject to the provisions

of paragraph 1.d. of this section; also, regular contributions made or costs incurred for more than a weekly period (but not less often than quarterly) under plans, funds, or programs which cover the particular weekly period, are deemed to be constructively made or incurred during such weekly period. Such laborers and mechanics shall be paid the appropriate wage rate and fringe benefits on the wage determination for the classification of work actually performed, without regard to skill, except as provided in 29 CFR 5.5(a)(4). Laborers or mechanics performing work in more than one classification may be compensated at the rate specified for each classification for the time actually worked therein: Provided, That the employer's payroll records accurately set forth the time spent in each classification in which work is performed. The wage determination (including any additional classification and wage rates conformed under paragraph 1.b. of this section) and the Davis-Bacon poster (WH-1321) shall be posted at all times by the contractor and its subcontractors at the site of the work in a prominent and accessible place where it can be easily seen by the workers.

b.(1) The contracting officer shall require that any class of laborers or mechanics, including helpers, which is not listed in the wage determination and which is to be employed under the contract shall be classified in conformance with the wage determination. The contracting officer shall approve an additional classification and wage rate and fringe benefits therefore only when the following criteria have been met:

(i) The work to be performed by the classification requested is not performed by a classification in the wage determination; and

(ii) The classification is utilized in the area by the construction industry; and

(iii) The proposed wage rate, including any bona fide fringe benefits, bears a reasonable relationship to the wage rates contained in the wage determination.

(2) If the contractor and the laborers and mechanics to be employed in the classification (if known), or their representatives, and the contracting officer agree on the classification and wage rate (including the amount designated for fringe benefits where appropriate), a report of the action taken shall be sent by the contracting officer to the Administrator of the Wage and Hour Division, Employment Standards Administration, U.S. Department of Labor, Washington, DC 20210. The Administrator, or an authorized representative, will approve, modify, or disapprove every additional classification action within 30 days of receipt and so advise the contracting officer or will notify the contracting officer within the 30-day period that additional time is necessary.

(3) In the event the contractor, the laborers or mechanics to be employed in the classification or their representatives, and the contracting officer do not agree on the proposed classification and wage rate (including the amount designated for fringe benefits, where appropriate), the contracting officer shall refer the questions, including the views of all interested parties and the recommendation of the contracting officer, to the Wage and Hour Administrator for determination. The Wage and Hour Administrator, or an authorized representative, will issue a determination within 30 days of receipt and so advise the contracting officer or



will notify the contracting officer within the 30-day period that additional time is necessary.

(4) The wage rate (including fringe benefits where appropriate) determined pursuant to paragraphs 1.b.(2) or 1.b.(3) of this section, shall be paid to all workers performing work in the classification under this contract from the first day on which work is performed in the classification.

c. Whenever the minimum wage rate prescribed in the contract for a class of laborers or mechanics includes a fringe benefit which is not expressed as an hourly rate, the contractor shall either pay the benefit as stated in the wage determination or shall pay another bona fide fringe benefit or an hourly cash equivalent thereof.

d. If the contractor does not make payments to a trustee or other third person, the contractor may consider as part of the wages of any laborer or mechanic the amount of any costs reasonably anticipated in providing bona fide fringe benefits under a plan or program. Provided, That the Secretary of Labor has found, upon the written request of the contractor, that the applicable standards of the Davis-Bacon Act have been met. The Secretary of Labor may require the contractor to set aside in a separate account assets for the meeting of obligations under the plan or program.

## 2. Withholding

The contracting agency shall upon its own action or upon written request of an authorized representative of the Department of Labor, withhold or cause to be withheld from the contractor under this contract, or any other Federal contract with the same prime contractor, or any other federally-assisted contract subject to Davis-Bacon prevailing wage requirements, which is held by the same prime contractor, so much of the accrued payments or advances as may be considered necessary to pay laborers and mechanics, including apprentices, trainees, and helpers, employed by the contractor or any subcontractor the full amount of wages required by the contract. In the event of failure to pay any laborer or mechanic, including any apprentice, trainee, or helper, employed or working on the site of the work, all or part of the wages required by the contract, the contracting agency may, after written notice to the contractor, take such action as may be necessary to cause the suspension of any further payment, advance, or guarantee of funds until such violations have ceased.

## 3. Payrolls and basic records

a. Payrolls and basic records relating thereto shall be maintained by the contractor during the course of the work and preserved for a period of three years thereafter for all laborers and mechanics working at the site of the work. Such records shall contain the name, address, and social security number of each such worker, his or her correct classification, hourly rates of wages paid (including rates of contributions or costs anticipated for bona fide fringe benefits or cash equivalents thereof of the types described in section 1(b)(2)(B) of the Davis-Bacon Act), daily and weekly number of hours worked, deductions made and actual wages paid. Whenever the Secretary of Labor has found under 29 CFR 5.5(a)(1)(iv) that the wages of any laborer or mechanic include the amount of any costs reasonably anticipated in providing benefits under a plan or program described in section 1(b)(2)(B) of the Davis-

Bacon Act, the contractor shall maintain records which show that the commitment to provide such benefits is enforceable, that the plan or program is financially responsible, and that the plan or program has been communicated in writing to the laborers or mechanics affected, and records which show the costs anticipated or the actual cost incurred in providing such benefits. Contractors employing apprentices or trainees under approved programs shall maintain written evidence of the registration of apprenticeship programs and certification of trainee programs, the registration of the apprentices and trainees, and the ratios and wage rates prescribed in the applicable programs.

b.(1) The contractor shall submit weekly for each week in which any contract work is performed a copy of all payrolls to the contracting agency. The payrolls submitted shall set out accurately and completely all of the information required to be maintained under 29 CFR 5.5(a)(3)(i), except that full social security numbers and home addresses shall not be included on weekly transmittals. Instead the payrolls shall only need to include an individually identifying number for each employee (e.g., the last four digits of the employee's social security number). The required weekly payroll information may be submitted in any form desired. Optional Form WH-347 is available for this purpose from the Wage and Hour Division Web site at <http://www.dol.gov/esa/whd/forms/wh347instr.htm> or its successor site. The prime contractor is responsible for the submission of copies of payrolls by all subcontractors. Contractors and subcontractors shall maintain the full social security number and current address of each covered worker, and shall provide them upon request to the contracting agency for transmission to the State DOT, the FHWA or the Wage and Hour Division of the Department of Labor for purposes of an investigation or audit of compliance with prevailing wage requirements. It is not a violation of this section for a prime contractor to require a subcontractor to provide addresses and social security numbers to the prime contractor for its own records, without weekly submission to the contracting agency..

(2) Each payroll submitted shall be accompanied by a "Statement of Compliance," signed by the contractor or subcontractor or his or her agent who pays or supervises the payment of the persons employed under the contract and shall certify the following:

(i) That the payroll for the payroll period contains the information required to be provided under §5.5 (a)(3)(ii) of Regulations, 29 CFR part 5, the appropriate information is being maintained under §5.5 (a)(3)(i) of Regulations, 29 CFR part 5, and that such information is correct and complete;

(ii) That each laborer or mechanic (including each helper, apprentice, and trainee) employed on the contract during the payroll period has been paid the full weekly wages earned, without rebate, either directly or indirectly, and that no deductions have been made either directly or indirectly from the full wages earned, other than permissible deductions as set forth in Regulations, 29 CFR part 3;

(iii) That each laborer or mechanic has been paid not less than the applicable wage rates and fringe benefits or cash equivalents for the classification of work performed, as specified in the applicable wage determination incorporated into the contract.

(3) The weekly submission of a properly executed certification set forth on the reverse side of Optional Form WH-347 shall satisfy the requirement for submission of the "Statement of Compliance" required by paragraph 3.b.(2) of this section.

(4) The falsification of any of the above certifications may subject the contractor or subcontractor to civil or criminal prosecution under section 1001 of title 18 and section 231 of title 31 of the United States Code.

c. The contractor or subcontractor shall make the records required under paragraph 3.a. of this section available for inspection, copying, or transcription by authorized representatives of the contracting agency, the State DOT, the FHWA, or the Department of Labor, and shall permit such representatives to interview employees during working hours on the job. If the contractor or subcontractor fails to submit the required records or to make them available, the FHWA may, after written notice to the contractor, the contracting agency or the State DOT, take such action as may be necessary to cause the suspension of any further payment, advance, or guarantee of funds. Furthermore, failure to submit the required records upon request or to make such records available may be grounds for debarment action pursuant to 29 CFR 5.12.

#### 4. Apprentices and trainees

##### a. Apprentices (programs of the USDOL).

Apprentices will be permitted to work at less than the predetermined rate for the work they performed when they are employed pursuant to and individually registered in a bona fide apprenticeship program registered with the U.S. Department of Labor, Employment and Training Administration, Office of Apprenticeship Training, Employer and Labor Services, or with a State Apprenticeship Agency recognized by the Office, or if a person is employed in his or her first 90 days of probationary employment as an apprentice in such an apprenticeship program, who is not individually registered in the program, but who has been certified by the Office of Apprenticeship Training, Employer and Labor Services or a State Apprenticeship Agency (where appropriate) to be eligible for probationary employment as an apprentice.

The allowable ratio of apprentices to journeymen on the job site in any craft classification shall not be greater than the ratio permitted to the contractor as to the entire work force under the registered program. Any worker listed on a payroll at an apprentice wage rate, who is not registered or otherwise employed as stated above, shall be paid not less than the applicable wage rate on the wage determination for the classification of work actually performed. In addition, any apprentice performing work on the job site in excess of the ratio permitted under the registered program shall be paid not less than the applicable wage rate on the wage determination for the work actually performed. Where a contractor is performing construction on a project in a locality other than that in which its program is registered, the ratios and wage rates (expressed in percentages of the journeyman's hourly rate) specified in the contractor's or subcontractor's registered program shall be observed.

Every apprentice must be paid at not less than the rate specified in the registered program for the apprentice's level of progress, expressed as a percentage of the journeymen hourly

rate specified in the applicable wage determination. Apprentices shall be paid fringe benefits in accordance with the provisions of the apprenticeship program. If the apprenticeship program does not specify fringe benefits, apprentices must be paid the full amount of fringe benefits listed on the wage determination for the applicable classification. If the Administrator determines that a different practice prevails for the applicable apprentice classification, fringes shall be paid in accordance with that determination.

In the event the Office of Apprenticeship Training, Employer and Labor Services, or a State Apprenticeship Agency recognized by the Office, withdraws approval of an apprenticeship program, the contractor will no longer be permitted to utilize apprentices at less than the applicable predetermined rate for the work performed until an acceptable program is approved.

##### b. Trainees (programs of the USDOL).

Except as provided in 29 CFR 5.16, trainees will not be permitted to work at less than the predetermined rate for the work performed unless they are employed pursuant to and individually registered in a program which has received prior approval, evidenced by formal certification by the U.S. Department of Labor, Employment and Training Administration.

The ratio of trainees to journeymen on the job site shall not be greater than permitted under the plan approved by the Employment and Training Administration.

Every trainee must be paid at not less than the rate specified in the approved program for the trainee's level of progress, expressed as a percentage of the journeyman hourly rate specified in the applicable wage determination. Trainees shall be paid fringe benefits in accordance with the provisions of the trainee program. If the trainee program does not mention fringe benefits, trainees shall be paid the full amount of fringe benefits listed on the wage determination unless the Administrator of the Wage and Hour Division determines that there is an apprenticeship program associated with the corresponding journeyman wage rate on the wage determination which provides for less than full fringe benefits for apprentices. Any employee listed on the payroll at a trainee rate who is not registered and participating in a training plan approved by the Employment and Training Administration shall be paid not less than the applicable wage rate on the wage determination for the classification of work actually performed. In addition, any trainee performing work on the job site in excess of the ratio permitted under the registered program shall be paid not less than the applicable wage rate on the wage determination for the work actually performed.

In the event the Employment and Training Administration withdraws approval of a training program, the contractor will no longer be permitted to utilize trainees at less than the applicable predetermined rate for the work performed until an acceptable program is approved.

c. Equal employment opportunity. The utilization of apprentices, trainees and journeymen under this part shall be in conformity with the equal employment opportunity requirements of Executive Order 11246, as amended, and 29 CFR part 30.

d. Apprentices and Trainees (programs of the U.S. DOT).

Apprentices and trainees working under apprenticeship and skill training programs which have been certified by the Secretary of Transportation as promoting EEO in connection with Federal-aid highway construction programs are not subject to the requirements of paragraph 4 of this Section IV. The straight time hourly wage rates for apprentices and trainees under such programs will be established by the particular programs. The ratio of apprentices and trainees to journeymen shall not be greater than permitted by the terms of the particular program.

**5. Compliance with Copeland Act requirements.** The contractor shall comply with the requirements of 29 CFR part 3, which are incorporated by reference in this contract.

**6. Subcontracts.** The contractor or subcontractor shall insert Form FHWA-1273 in any subcontracts and also require the subcontractors to include Form FHWA-1273 in any lower tier subcontracts. The prime contractor shall be responsible for the compliance by any subcontractor or lower tier subcontractor with all the contract clauses in 29 CFR 5.5.

**7. Contract termination: debarment.** A breach of the contract clauses in 29 CFR 5.5 may be grounds for termination of the contract, and for debarment as a contractor and a subcontractor as provided in 29 CFR 5.12.

**8. Compliance with Davis-Bacon and Related Act requirements.** All rulings and interpretations of the Davis-Bacon and Related Acts contained in 29 CFR parts 1, 3, and 5 are herein incorporated by reference in this contract.

**9. Disputes concerning labor standards.** Disputes arising out of the labor standards provisions of this contract shall not be subject to the general disputes clause of this contract. Such disputes shall be resolved in accordance with the procedures of the Department of Labor set forth in 29 CFR parts 5, 6, and 7. Disputes within the meaning of this clause include disputes between the contractor (or any of its subcontractors) and the contracting agency, the U.S. Department of Labor, or the employees or their representatives.

**10. Certification of eligibility.**

a. By entering into this contract, the contractor certifies that neither it (nor he or she) nor any person or firm who has an interest in the contractor's firm is a person or firm ineligible to be awarded Government contracts by virtue of section 3(a) of the Davis-Bacon Act or 29 CFR 5.12(a)(1).

b. No part of this contract shall be subcontracted to any person or firm ineligible for award of a Government contract by virtue of section 3(a) of the Davis-Bacon Act or 29 CFR 5.12(a)(1).

c. The penalty for making false statements is prescribed in the U.S. Criminal Code, 18 U.S.C. 1001.

**V. CONTRACT WORK HOURS AND SAFETY STANDARDS ACT**

The following clauses apply to any Federal-aid construction contract in an amount in excess of \$100,000 and subject to the overtime provisions of the Contract Work Hours and Safety Standards Act. These clauses shall be inserted in addition to the clauses required by 29 CFR 5.5(a) or 29 CFR 4.6. As used in this paragraph, the terms laborers and mechanics include watchmen and guards.

**1. Overtime requirements.** No contractor or subcontractor contracting for any part of the contract work which may require or involve the employment of laborers or mechanics shall require or permit any such laborer or mechanic in any workweek in which he or she is employed on such work to work in excess of forty hours in such workweek unless such laborer or mechanic receives compensation at a rate not less than one and one-half times the basic rate of pay for all hours worked in excess of forty hours in such workweek.

**2. Violation; liability for unpaid wages; liquidated damages.** In the event of any violation of the clause set forth in paragraph (1.) of this section, the contractor and any subcontractor responsible therefor shall be liable for the unpaid wages. In addition, such contractor and subcontractor shall be liable to the United States (in the case of work done under contract for the District of Columbia or a territory, to such District or to such territory), for liquidated damages. Such liquidated damages shall be computed with respect to each individual laborer or mechanic, including watchmen and guards, employed in violation of the clause set forth in paragraph (1.) of this section, in the sum of \$10 for each calendar day on which such individual was required or permitted to work in excess of the standard workweek of forty hours without payment of the overtime wages required by the clause set forth in paragraph (1.) of this section.

**3. Withholding for unpaid wages and liquidated damages.** The FHWA or the contracting agency shall upon its own action or upon written request of an authorized representative of the Department of Labor withhold or cause to be withheld, from any moneys payable on account of work performed by the contractor or subcontractor under any such contract or any other Federal contract with the same prime contractor, or any other federally-assisted contract subject to the Contract Work Hours and Safety Standards Act, which is held by the same prime contractor, such sums as may be determined to be necessary to satisfy any liabilities of such contractor or subcontractor for unpaid wages and liquidated damages as provided in the clause set forth in paragraph (2.) of this section.

**4. Subcontracts.** The contractor or subcontractor shall insert in any subcontracts the clauses set forth in paragraph (1.) through (4.) of this section and also a clause requiring the subcontractors to include these clauses in any lower tier subcontracts. The prime contractor shall be responsible for compliance by any subcontractor or lower tier subcontractor with the clauses set forth in paragraphs (1.) through (4.) of this section.

## VI. SUBLETTING OR ASSIGNING THE CONTRACT

This provision is applicable to all Federal-aid construction contracts on the National Highway System.

1. The contractor shall perform with its own organization contract work amounting to not less than 30 percent (or a greater percentage if specified elsewhere in the contract) of the total original contract price, excluding any specialty items designated by the contracting agency. Specialty items may be performed by subcontract and the amount of any such specialty items performed may be deducted from the total original contract price before computing the amount of work required to be performed by the contractor's own organization (23 CFR 635.116).

a. The term "perform work with its own organization" refers to workers employed or leased by the prime contractor, and equipment owned or rented by the prime contractor, with or without operators. Such term does not include employees or equipment of a subcontractor or lower tier subcontractor, agents of the prime contractor, or any other assignees. The term may include payments for the costs of hiring leased employees from an employee leasing firm meeting all relevant Federal and State regulatory requirements. Leased employees may only be included in this term if the prime contractor meets all of the following conditions:

(1) the prime contractor maintains control over the supervision of the day-to-day activities of the leased employees;

(2) the prime contractor remains responsible for the quality of the work of the leased employees;

(3) the prime contractor retains all power to accept or exclude individual employees from work on the project; and

(4) the prime contractor remains ultimately responsible for the payment of predetermined minimum wages, the submission of payrolls, statements of compliance and all other Federal regulatory requirements.

b. "Specialty Items" shall be construed to be limited to work that requires highly specialized knowledge, abilities, or equipment not ordinarily available in the type of contracting organizations qualified and expected to bid or propose on the contract as a whole and in general are to be limited to minor components of the overall contract.

2. The contract amount upon which the requirements set forth in paragraph (1) of Section VI is computed includes the cost of material and manufactured products which are to be purchased or produced by the contractor under the contract provisions.

3. The contractor shall furnish (a) a competent superintendent or supervisor who is employed by the firm, has full authority to direct performance of the work in accordance with the contract requirements, and is in charge of all construction operations (regardless of who performs the work) and (b) such other of its own organizational resources (supervision, management, and engineering services) as the contracting officer determines is necessary to assure the performance of the contract.

4. No portion of the contract shall be sublet, assigned or otherwise disposed of except with the written consent of the contracting officer, or authorized representative, and such consent when given shall not be construed to relieve the contractor of any responsibility for the fulfillment of the contract. Written consent will be given only after the contracting agency has assured that each subcontract is

evidenced in writing and that it contains all pertinent provisions and requirements of the prime contract.

5. The 30% self-performance requirement of paragraph (1) is not applicable to design-build contracts; however, contracting agencies may establish their own self-performance requirements.

## VII. SAFETY: ACCIDENT PREVENTION

This provision is applicable to all Federal-aid construction contracts and to all related subcontracts.

1. In the performance of this contract the contractor shall comply with all applicable Federal, State, and local laws governing safety, health, and sanitation (23 CFR 635). The contractor shall provide all safeguards, safety devices and protective equipment and take any other needed actions as it determines, or as the contracting officer may determine, to be reasonably necessary to protect the life and health of employees on the job and the safety of the public and to protect property in connection with the performance of the work covered by the contract.

2. It is a condition of this contract, and shall be made a condition of each subcontract, which the contractor enters into pursuant to this contract, that the contractor and any subcontractor shall not permit any employee, in performance of the contract, to work in surroundings or under conditions which are unsanitary, hazardous or dangerous to his/her health or safety, as determined under construction safety and health standards (29 CFR 1926) promulgated by the Secretary of Labor, in accordance with Section 107 of the Contract Work Hours and Safety Standards Act (40 U.S.C. 3704).

3. Pursuant to 29 CFR 1926.3, it is a condition of this contract that the Secretary of Labor or authorized representative thereof, shall have right of entry to any site of contract performance to inspect or investigate the matter of compliance with the construction safety and health standards and to carry out the duties of the Secretary under Section 107 of the Contract Work Hours and Safety Standards Act (40 U.S.C.3704).

## VIII. FALSE STATEMENTS CONCERNING HIGHWAY PROJECTS

This provision is applicable to all Federal-aid construction contracts and to all related subcontracts.

In order to assure high quality and durable construction in conformity with approved plans and specifications and a high degree of reliability on statements and representations made by engineers, contractors, suppliers, and workers on Federal-aid highway projects, it is essential that all persons concerned with the project perform their functions as carefully, thoroughly, and honestly as possible. Willful falsification, distortion, or misrepresentation with respect to any facts related to the project is a violation of Federal law. To prevent any misunderstanding regarding the seriousness of these and similar acts, Form FHWA-1022 shall be posted on each Federal-aid highway project (23 CFR 635) in one or more places where it is readily available to all persons concerned with the project:

18 U.S.C. 1020 reads as follows:



"Whoever, being an officer, agent, or employee of the United States, or of any State or Territory, or whoever, whether a person, association, firm, or corporation, knowingly makes any false statement, false representation, or false report as to the character, quality, quantity, or cost of the material used or to be used, or the quantity or quality of the work performed or to be performed, or the cost thereof in connection with the submission of plans, maps, specifications, contracts, or costs of construction on any highway or related project submitted for approval to the Secretary of Transportation; or

Whoever knowingly makes any false statement, false representation, false report or false claim with respect to the character, quality, quantity, or cost of any work performed or to be performed, or materials furnished or to be furnished, in connection with the construction of any highway or related project approved by the Secretary of Transportation; or

Whoever knowingly makes any false statement or false representation as to material fact in any statement, certificate, or report submitted pursuant to provisions of the Federal-aid Roads Act approved July 1, 1916, (39 Stat. 355), as amended and supplemented;

Shall be fined under this title or imprisoned not more than 5 years or both."

#### **IX. IMPLEMENTATION OF CLEAN AIR ACT AND FEDERAL WATER POLLUTION CONTROL ACT**

This provision is applicable to all Federal-aid construction contracts and to all related subcontracts.

By submission of this bid/proposal or the execution of this contract, or subcontract, as appropriate, the bidder, proposer, Federal-aid construction contractor, or subcontractor, as appropriate, will be deemed to have stipulated as follows:

1. That any person who is or will be utilized in the performance of this contract is not prohibited from receiving an award due to a violation of Section 508 of the Clean Water Act or Section 306 of the Clean Air Act.

2. That the contractor agrees to include or cause to be included the requirements of paragraph (1) of this Section X in every subcontract, and further agrees to take such action as the contracting agency may direct as a means of enforcing such requirements.

#### **X. CERTIFICATION REGARDING DEBARMENT, SUSPENSION, INELIGIBILITY AND VOLUNTARY EXCLUSION**

This provision is applicable to all Federal-aid construction contracts, design-build contracts, subcontracts, lower-tier subcontracts, purchase orders, lease agreements, consultant contracts or any other covered transaction requiring FHWA approval or that is estimated to cost \$25,000 or more – as defined in 2 CFR Parts 180 and 1200.

##### **1. Instructions for Certification – First Tier Participants:**

a. By signing and submitting this proposal, the prospective first tier participant is providing the certification set out below.

b. The inability of a person to provide the certification set out below will not necessarily result in denial of participation in this

covered transaction. The prospective first tier participant shall submit an explanation of why it cannot provide the certification set out below. The certification or explanation will be considered in connection with the department or agency's determination whether to enter into this transaction. However, failure of the prospective first tier participant to furnish a certification or an explanation shall disqualify such a person from participation in this transaction.

c. The certification in this clause is a material representation of fact upon which reliance was placed when the contracting agency determined to enter into this transaction. If it is later determined that the prospective participant knowingly rendered an erroneous certification, in addition to other remedies available to the Federal Government, the contracting agency may terminate this transaction for cause of default.

d. The prospective first tier participant shall provide immediate written notice to the contracting agency to whom this proposal is submitted if any time the prospective first tier participant learns that its certification was erroneous when submitted or has become erroneous by reason of changed circumstances.

e. The terms "covered transaction," "debarred," "suspended," "ineligible," "participant," "person," "principal," and "voluntarily excluded," as used in this clause, are defined in 2 CFR Parts 180 and 1200. "First Tier Covered Transactions" refers to any covered transaction between a grantee or subgrantee of Federal funds and a participant (such as the prime or general contract). "Lower Tier Covered Transactions" refers to any covered transaction under a First Tier Covered Transaction (such as subcontracts). "First Tier Participant" refers to the participant who has entered into a covered transaction with a grantee or subgrantee of Federal funds (such as the prime or general contractor). "Lower Tier Participant" refers any participant who has entered into a covered transaction with a First Tier Participant or other Lower Tier Participants (such as subcontractors and suppliers).

f. The prospective first tier participant agrees by submitting this proposal that, should the proposed covered transaction be entered into, it shall not knowingly enter into any lower tier covered transaction with a person who is debarred, suspended, declared ineligible, or voluntarily excluded from participation in this covered transaction, unless authorized by the department or agency entering into this transaction.

g. The prospective first tier participant further agrees by submitting this proposal that it will include the clause titled "Certification Regarding Debarment, Suspension, Ineligibility and Voluntary Exclusion-Lower Tier Covered Transactions," provided by the department or contracting agency, entering into this covered transaction, without modification, in all lower tier covered transactions and in all solicitations for lower tier covered transactions exceeding the \$25,000 threshold.

h. A participant in a covered transaction may rely upon a certification of a prospective participant in a lower tier covered transaction that is not debarred, suspended, ineligible, or voluntarily excluded from the covered transaction, unless it knows that the certification is erroneous. A participant is responsible for ensuring that its principals are not suspended, debarred, or otherwise ineligible to participate in covered transactions. To verify the eligibility of its principals, as well as the eligibility of any lower tier prospective participants, each participant may, but is not required to, check the Excluded Parties List System website (<https://www.epls.gov/>), which is compiled by the General Services Administration.

i. Nothing contained in the foregoing shall be construed to require the establishment of a system of records in order to render in good faith the certification required by this clause. The knowledge and information of the prospective participant is not required to exceed that which is normally possessed by a prudent person in the ordinary course of business dealings.

j. Except for transactions authorized under paragraph (f) of these instructions, if a participant in a covered transaction knowingly enters into a lower tier covered transaction with a person who is suspended, debarred, ineligible, or voluntarily excluded from participation in this transaction, in addition to other remedies available to the Federal Government, the department or agency may terminate this transaction for cause or default.

\* \* \* \* \*

## **2. Certification Regarding Debarment, Suspension, Ineligibility and Voluntary Exclusion – First Tier Participants:**

a. The prospective first tier participant certifies to the best of its knowledge and belief, that it and its principals:

(1) Are not presently debarred, suspended, proposed for debarment, declared ineligible, or voluntarily excluded from participating in covered transactions by any Federal department or agency;

(2) Have not within a three-year period preceding this proposal been convicted of or had a civil judgment rendered against them for commission of fraud or a criminal offense in connection with obtaining, attempting to obtain, or performing a public (Federal, State or local) transaction or contract under a public transaction; violation of Federal or State antitrust statutes or commission of embezzlement, theft, forgery, bribery, falsification or destruction of records, making false statements, or receiving stolen property;

(3) Are not presently indicted for or otherwise criminally or civilly charged by a governmental entity (Federal, State or local) with commission of any of the offenses enumerated in paragraph (a)(2) of this certification; and

(4) Have not within a three-year period preceding this application/proposal had one or more public transactions (Federal, State or local) terminated for cause or default.

b. Where the prospective participant is unable to certify to any of the statements in this certification, such prospective participant shall attach an explanation to this proposal.

### **2. Instructions for Certification - Lower Tier Participants:**

(Applicable to all subcontracts, purchase orders and other lower tier transactions requiring prior FHWA approval or estimated to cost \$25,000 or more - 2 CFR Parts 180 and 1200)

a. By signing and submitting this proposal, the prospective lower tier is providing the certification set out below.

b. The certification in this clause is a material representation of fact upon which reliance was placed when this transaction was entered into. If it is later determined that the prospective lower tier participant knowingly rendered an erroneous certification, in addition to other remedies available to the Federal Government, the department, or agency with which

this transaction originated may pursue available remedies, including suspension and/or debarment.

c. The prospective lower tier participant shall provide immediate written notice to the person to which this proposal is submitted if at any time the prospective lower tier participant learns that its certification was erroneous by reason of changed circumstances.

d. The terms "covered transaction," "debarred," "suspended," "ineligible," "participant," "person," "principal," and "voluntarily excluded," as used in this clause, are defined in 2 CFR Parts 180 and 1200. You may contact the person to which this proposal is submitted for assistance in obtaining a copy of those regulations. "First Tier Covered Transactions" refers to any covered transaction between a grantee or subgrantee of Federal funds and a participant (such as the prime or general contract). "Lower Tier Covered Transactions" refers to any covered transaction under a First Tier Covered Transaction (such as subcontracts). "First Tier Participant" refers to the participant who has entered into a covered transaction with a grantee or subgrantee of Federal funds (such as the prime or general contractor). "Lower Tier Participant" refers any participant who has entered into a covered transaction with a First Tier Participant or other Lower Tier Participants (such as subcontractors and suppliers).

e. The prospective lower tier participant agrees by submitting this proposal that, should the proposed covered transaction be entered into, it shall not knowingly enter into any lower tier covered transaction with a person who is debarred, suspended, declared ineligible, or voluntarily excluded from participation in this covered transaction, unless authorized by the department or agency with which this transaction originated.

f. The prospective lower tier participant further agrees by submitting this proposal that it will include this clause titled "Certification Regarding Debarment, Suspension, Ineligibility and Voluntary Exclusion-Lower Tier Covered Transaction," without modification, in all lower tier covered transactions and in all solicitations for lower tier covered transactions exceeding the \$25,000 threshold.

g. A participant in a covered transaction may rely upon a certification of a prospective participant in a lower tier covered transaction that is not debarred, suspended, ineligible, or voluntarily excluded from the covered transaction, unless it knows that the certification is erroneous. A participant is responsible for ensuring that its principals are not suspended, debarred, or otherwise ineligible to participate in covered transactions. To verify the eligibility of its principals, as well as the eligibility of any lower tier prospective participants, each participant may, but is not required to, check the Excluded Parties List System website (<https://www.epls.gov/>), which is compiled by the General Services Administration.

h. Nothing contained in the foregoing shall be construed to require establishment of a system of records in order to render in good faith the certification required by this clause. The knowledge and information of participant is not required to exceed that which is normally possessed by a prudent person in the ordinary course of business dealings.

i. Except for transactions authorized under paragraph e of these instructions, if a participant in a covered transaction knowingly enters into a lower tier covered transaction with a person who is suspended, debarred, ineligible, or voluntarily excluded from participation in this transaction, in addition to other remedies available to the Federal Government, the

department or agency with which this transaction originated may pursue available remedies, including suspension and/or debarment.

\* \* \* \* \*

**Certification Regarding Debarment, Suspension, Ineligibility and Voluntary Exclusion--Lower Tier Participants:**

1. The prospective lower tier participant certifies, by submission of this proposal, that neither it nor its principals is presently debarred, suspended, proposed for debarment, declared ineligible, or voluntarily excluded from participating in covered transactions by any Federal department or agency.

2. Where the prospective lower tier participant is unable to certify to any of the statements in this certification, such prospective participant shall attach an explanation to this proposal.

\* \* \* \* \*

**XI. CERTIFICATION REGARDING USE OF CONTRACT FUNDS FOR LOBBYING**

This provision is applicable to all Federal-aid construction contracts and to all related subcontracts which exceed \$100,000 (49 CFR 20).

1. The prospective participant certifies, by signing and submitting this bid or proposal, to the best of his or her knowledge and belief, that:

a. No Federal appropriated funds have been paid or will be paid, by or on behalf of the undersigned, to any person for influencing or attempting to influence an officer or employee of any Federal agency, a Member of Congress, an officer or employee of Congress, or an employee of a Member of Congress in connection with the awarding of any Federal contract, the making of any Federal grant, the making of any Federal loan, the entering into of any cooperative agreement, and the extension, continuation, renewal, amendment, or modification of any Federal contract, grant, loan, or cooperative agreement.

b. If any funds other than Federal appropriated funds have been paid or will be paid to any person for influencing or attempting to influence an officer or employee of any Federal agency, a Member of Congress, an officer or employee of Congress, or an employee of a Member of Congress in connection with this Federal contract, grant, loan, or cooperative agreement, the undersigned shall complete and submit Standard Form-LLL, "Disclosure Form to Report Lobbying," in accordance with its instructions.

2. This certification is a material representation of fact upon which reliance was placed when this transaction was made or entered into. Submission of this certification is a prerequisite for making or entering into this transaction imposed by 31 U.S.C. 1352. Any person who fails to file the required certification shall be subject to a civil penalty of not less than \$10,000 and not more than \$100,000 for each such failure.

3. The prospective participant also agrees by submitting its bid or proposal that the participant shall require that the language of this certification be included in all lower tier subcontracts, which exceed \$100,000 and that all such recipients shall certify and disclose accordingly.

**ATTACHMENT A - EMPLOYMENT AND MATERIALS  
PREFERENCE FOR APPALACHIAN DEVELOPMENT  
HIGHWAY SYSTEM OR APPALACHIAN LOCAL ACCESS  
ROAD CONTRACTS**

This provision is applicable to all Federal-aid projects funded under the Appalachian Regional Development Act of 1965.

1. During the performance of this contract, the contractor undertaking to do work which is, or reasonably may be, done as on-site work, shall give preference to qualified persons who regularly reside in the labor area as designated by the DOL wherein the contract work is situated, or the subregion, or the Appalachian counties of the State wherein the contract work is situated, except:

a. To the extent that qualified persons regularly residing in the area are not available.

b. For the reasonable needs of the contractor to employ supervisory or specially experienced personnel necessary to assure an efficient execution of the contract work.

c. For the obligation of the contractor to offer employment to present or former employees as the result of a lawful collective bargaining contract, provided that the number of nonresident persons employed under this subparagraph (1c) shall not exceed 20 percent of the total number of employees employed by the contractor on the contract work, except as provided in subparagraph (4) below.

2. The contractor shall place a job order with the State Employment Service indicating (a) the classifications of the laborers, mechanics and other employees required to perform the contract work, (b) the number of employees required in each classification, (c) the date on which the participant estimates such employees will be required, and (d) any other pertinent information required by the State Employment Service to complete the job order form. The job order may be placed with the State Employment Service in writing or by telephone. If during the course of the contract work, the information submitted by the contractor in the original job order is substantially modified, the participant shall promptly notify the State Employment Service.

3. The contractor shall give full consideration to all qualified job applicants referred to him by the State Employment Service. The contractor is not required to grant employment to any job applicants who, in his opinion, are not qualified to perform the classification of work required.

4. If, within one week following the placing of a job order by the contractor with the State Employment Service, the State Employment Service is unable to refer any qualified job applicants to the contractor, or less than the number requested, the State Employment Service will forward a certificate to the contractor indicating the unavailability of applicants. Such certificate shall be made a part of the contractor's permanent project records. Upon receipt of this certificate, the contractor may employ persons who do not normally reside in the labor area to fill positions covered by the certificate, notwithstanding the provisions of subparagraph (1c) above.

5. The provisions of 23 CFR 633.207(e) allow the contracting agency to provide a contractual preference for the use of mineral resource materials native to the Appalachian region.

6. The contractor shall include the provisions of Sections 1 through 4 of this Attachment A in every subcontract for work which is, or reasonably may be, done as on-site work.

## **Non-discrimination Provisions**

**During the performance of this contract, the contractor, for itself, its assignees, and successors in interest (hereinafter referred to as the "contractor") agrees as follows:**

**1. Compliance with Regulations:** The contractor (hereinafter includes consultants) will comply with the Acts and the Regulations relative to Non-discrimination in Federally-assisted programs of the U.S. Department of Transportation, Federal Highway Administration, as they may be amended from time to time, which are herein incorporated by reference and made a part of this contract.

**2. Non-discrimination:** The contractor, with regard to the work performed by it during the contract, will not discriminate on the grounds of race, color, or national origin in the selection and retention of subcontractors, including procurements of materials and leases of equipment. The contractor will not participate directly or indirectly in the discrimination prohibited by the Acts and the Regulations, including employment practices when the contract covers any activity, project, or program set forth in Appendix B of 49 CFR Part 21.

**3. Solicitations for Subcontracts, Including Procurements of Materials and Equipment:** In all solicitations, either by competitive bidding, or negotiation made by the contractor for work to be performed under a subcontract, including procurements of materials, or leases of equipment, each potential subcontractor or supplier will be notified by the contractor of the contractor's obligations under this contract and the Acts and the Regulations relative to Non-discrimination on the grounds of race, color, or national origin.

**4. Information and Reports:** The contractor will provide all information and reports required by the Acts, the Regulations, and directives issued pursuant thereto and will permit access to its books, records, accounts, other sources of information, and its facilities as may be determined by the Recipient or the Federal Highway Administration to be pertinent to ascertain compliance with such Acts, Regulations, and instructions. Where any information required of a contractor is in the exclusive possession of another who fails or refuses to furnish the information, the contractor will so certify to the Recipient or the Federal Highway Administration, as appropriate, and will set forth what efforts it has made to obtain the information.

**5. Sanctions for Noncompliance:** In the event of a contractor's noncompliance with the Non-discrimination provisions of this contract, the Recipient will impose such contract sanctions as it or the Federal Highway Administration may determine to be appropriate, including, but not limited to:

- a. Withholding payments to the contractor under the contract until the contractor complies; and/or
- b. Cancelling, terminating, or suspending a contract, in whole or in part.

**6. Incorporation of Provisions:** The contractor will include the provisions of paragraphs one through six in every subcontract, including procurements of materials and leases of equipment, unless exempt by the Acts, the Regulations and directives issued pursuant thereto. The contractor will take action with respect to any subcontract or procurement as the Recipient or the Federal Highway Administration may direct as a means of enforcing such provisions including sanctions for noncompliance. Provided, that if the contractor becomes involved in, or is threatened with litigation by a subcontractor, or supplier because of such direction, the contractor may request the Recipient to enter into any litigation to protect the interests of the Recipient. In addition, the contractor may request the United States to enter into the litigation to protect the interests of the United States.

**During the performance of this contract, the contractor, for itself, its assignees, and successors in interest (hereinafter referred to as the "contractor") agrees to comply with the following non-discrimination statutes and authorities; including but not limited to:**

**Pertinent Non-Discrimination Authorities:**

- Title VI of the Civil Rights Act of 1964 (42 U.S.C. § 2000d et seq., 78 stat. 252), (prohibits discrimination on the basis of race, color, national origin); and 49 CFR Part 21.
- The Uniform Relocation Assistance and Real Property Acquisition Policies Act of 1970, (42 U.S.C. § 4601), (prohibits unfair treatment of persons displaced or whose property has been acquired because of Federal or Federal-aid programs and projects);
- Federal-Aid Highway Act of 1973, (23 U.S.C. § 324 et seq.), (prohibits discrimination on the basis of sex);
- Section 504 of the Rehabilitation Act of 1973, (29 U.S.C. § 794 et seq.), as amended, (prohibits discrimination on the basis of disability); and 49 CFR Part 27;
- The Age Discrimination Act of 1975, as amended, (42 U.S.C. § 6101 et seq.), (prohibits discrimination on the basis of age);
- Airport and Airway Improvement Act of 1982, (49 USC § 471, Section 47123), as amended, (prohibits discrimination based on race, creed, color, national origin, or sex);
- The Civil Rights Restoration Act of 1987, (PL 100-209), (Broadened the scope, coverage and applicability of Title VI of the Civil Rights Act of 1964, The Age Discrimination Act of 1975 and Section 504 of the Rehabilitation Act of 1973, by expanding the definition of the terms "programs or activities" to include all of the programs or activities of the Federal-aid recipients, sub-recipients and contractors, whether such programs or activities are Federally funded or not);
- Titles II and III of the Americans with Disabilities Act, which prohibit discrimination on the basis of disability in the operation of public entities, public and private transportation systems, places of public accommodation, and certain testing entities (42 U.S.C. §§ 12131-12189) as implemented by Department of Transportation regulations at 49 C.F.R. parts 37 and 38;
- The Federal Aviation Administration's Non-discrimination statute (49 U.S.C. § 47123) (prohibits discrimination on the basis of race, color, national origin, and sex);

- Executive Order 12898, Federal Actions to Address Environmental Justice in Minority Populations and Low-Income Populations, which ensures Non-discrimination against minority populations by discouraging programs, policies, and activities with disproportionately high and adverse human health or environmental effects on minority and low-income populations;
- Executive Order 13166, Improving Access to Services for Persons with Limited English Proficiency, and resulting agency guidance, national origin discrimination includes discrimination because of Limited English proficiency (LEP). To ensure compliance with Title VI, you must take reasonable steps to ensure that LEP persons have meaningful access to your programs (70 Fed. Reg. at 74087 to 74100);
- Title IX of the Education Amendments of 1972, as amended, which prohibits you from discriminating because of sex in education programs or activities (20 U.S.C. 1681 et seq).

**SEPTEMBER 2002**

**NOTICE OF REQUIREMENT FOR AFFIRMATIVE ACTION TO ENSURE  
EQUAL EMPLOYMENT OPPORTUNITY (EXECUTIVE ORDER 11246)**

1. The Offeror's or Bidder's attention is called to the "Employment Practices" and "Equal Opportunity Clause" set forth in the Required Contract Provisions, FHWA 1273.
2. The goals and timetables for minority and female participation expressed in percentage terms for the contractor's aggregate work force in each trade, on all construction work in the covered area, are as follows:

**Goals for Minority Participation for Each Trade:**

<u>County</u>	<u>%</u>	<u>County</u>	<u>%</u>	<u>County</u>	<u>%</u>
Adams	1.7	Iowa	1.7	Polk	2.2
Ashland	1.2	Iron	1.2	Portage	0.6
Barron	0.6	Jackson	0.6	Price	0.6
Bayfield	1.2	Jefferson	7.0	Racine	8.4
Brown	1.3	Juneau	0.6	Richland	1.7
Buffalo	0.6	Kenosha	3.0	Rock	3.1
Burnett	2.2	Kewaunee	1.0	Rusk	0.6
Calumet	0.9	La Crosse	0.9	St. Croix	2.9
Chippewa	0.5	Lafayette	0.5	Sauk	1.7
Clark	0.6	Langlade	0.6	Sawyer	0.6
Columbia	1.7	Lincoln	0.6	Shawano	1.0
Crawford	0.5	Manitowoc	1.0	Sheboygan	7.0
Dane	2.2	Marathon	0.6	Taylor	0.6
Dodge	7.0	Marinette	1.0	Trempealeau	0.6
Door	1.0	Marquette	1.7	Vernon	0.6
Douglas	1.0	Menominee	1.0	Vilas	0.6
Dunn	0.6	Milwaukee	8.0	Walworth	7.0
Eau Claire	0.5	Monroe	0.6	Washburn	0.6
Florence	1.0	Oconto	1.0	Washington	8.0
Fond du Lac	1.0	Oneida	0.6	Waukesha	8.0
Forest	1.0	Outagamie	0.9	Waupaca	1.0
Grant	0.5	Ozaukee	8.0	Waushara	1.0
Green	1.7	Pepin	0.6	Winnebago	0.9
Green Lake	1.0	Pierce	2.2	Wood	0.6



**Goals for female participation for each trade: 6.9%**

These goals are applicable to all the contractor's construction work, (whether or not it is federal or federally assisted), performed in the covered area. If the contractor performs construction work in the geographical area located outside of the covered area, it shall apply the goals established for such geographical area where the work is actually performed. With regard to this second area, the contractor also is subject to the goals for both its federally involved and nonfederally involved construction.

The contractor's compliance with the Executive Order and the Regulations in 41 CFR Part 60-4 shall be based on its implementation of the Equal Opportunity Clause, specific affirmative action obligations required by the specifications set forth in 41 CFR 60-4.3(a), and its efforts to meet the goals. The hours of minority and female employment and training must be substantially uniform throughout the length of the contract, and in each trade, and the contractor shall make a good faith effort to employ minorities and women evenly on each of its projects. The transfer of minority or female employees or trainees from contractor to contractor or from project to project for the sole purpose of meeting the contractor's goals shall be a violation of the contract, the Executive Order and the Regulations in 41 CFR Part 60-4. Compliance with the goals will be measured against the total work hours performed.

3. The contractor shall provide written notification to the Director of the Office of Federal Contract Compliance Programs within ten (10) working days of award of any construction subcontract in excess of \$10,000.00 at any tier for construction work under the contract resulting from this solicitation. The notification shall list the name, address and telephone number of the subcontractor, employer identification number of the subcontractor; estimated dollar amount of the subcontract; estimated starting and completion dates of the subcontract; and the geographical area in which the subcontract is to be performed.

As referred to in this section, the Director means:

Director  
Office of Federal Contract Compliance Programs  
Ruess Federal Plaza  
310 W. Wisconsin Ave., Suite 1115  
Milwaukee, WI 53202

The "Employer Identification Number" means the Federal Social Security number used on the Employer's Quarterly Federal Tax Return, U.S. Treasury Department Form 941.

4. As used in this notice, and in the contract resulting from solicitation, the "covered area" is the county(ies) in Wisconsin to which this proposal applies.

**APRIL 2013**

**ADDITIONAL FEDERAL-AID PROVISIONS**

**NOTICE TO ALL BIDDERS**

To report bid rigging activities call:

**1-800-424-9071**

The U.S. Department of Transportation (DOT) operates the above toll-free "hotline" Monday through Friday, 8:00 a.m. to 5:00 p.m., Eastern Time. Anyone with knowledge of possible bid rigging, bidding collusion, or other fraudulent activities should use the "hotline" to report such activities.

The "hotline" is part of the DOT's continuing effort to identify and investigate highway construction contract fraud and abuse and is operated under the direction of the DOT Inspector General. All information will be treated confidentially and caller anonymity will be respected.

**Effective November 2020 letting**

### **BUY AMERICA PROVISION**

All steel and iron materials permanently incorporated in this project shall be domestic products and all manufacturing and coating processes for these materials from smelting forward in the manufacturing process must have occurred within the United States. Coating includes epoxy coating, galvanizing, painting and any other coating that protects or enhances the value of a material subject to the requirements of Buy America. The exemption of this requirement is the minimal use of foreign materials if the total cost of such material permanently incorporated in the product does not exceed one-tenth of one percent (1/10 of 1%) of the total contract cost or \$2,500.00, whichever is greater. For purposes of this paragraph, the cost is that shown to be the value of the subject products as they are delivered to the project. The contractor shall take actions and provide documentation conforming to CMM 2-28.5 to ensure compliance with this "Buy America" provision.

<https://wisconsindot.gov/rdwy/cmm/cm-02-28.pdf>

Upon completion of the project certify to the engineer, in writing using department form DT4567, that all steel, iron, and coating processes for steel or iron incorporated into the contract work conform to these "Buy America" provisions. Attach a list of exemptions and their associated costs to the certification form. Department form DT4567 is available at:

<https://wisconsindot.gov/Documents/formdocs/dt4567.docx>

## Cargo Preference Act Requirement

All Federal-aid projects shall comply with 46 CFR 381.7 (a) – (b) as follows:

(a) *Agreement Clauses*. "Use of United States-flag vessels:"

(1) Pursuant to Pub. L. 664 (43 U.S.C. 1241(b)) at least 50 percent of any equipment, materials or commodities procured, contracted for or otherwise obtained with funds granted, guaranteed, loaned, or advanced by the U.S. Government under this agreement, and which may be transported by ocean vessel, shall be transported on privately owned United States-flag commercial vessels, if available.

(2) Within 20 days following the date of loading for shipments originating within the United States or within 30 working days following the date of loading for shipments originating outside the United States, a legible copy of a rated, 'on-board' commercial ocean bill-of-lading in English for each shipment of cargo described in paragraph (a)(1) of this section shall be furnished to both the Contracting Officer (through the prime contractor in the case of subcontractor bills-of-lading) and to the Division of National Cargo, Office of Market Development, Maritime Administration, Washington, DC 20590."

(b) *Contractor and Subcontractor Clauses*. "Use of United States-flag vessels: The contractor agrees—"

(1) To utilize privately owned United States-flag commercial vessels to ship at least 50 percent of the gross tonnage (computed separately for dry bulk carriers, dry cargo liners, and tankers) involved, whenever shipping any equipment, material, or commodities pursuant to this contract, to the extent such vessels are available at fair and reasonable rates for United States-flag commercial vessels.

(2) To furnish within 20 days following the date of loading for shipments originating within the United States or within 30 working days following the date of loading for shipments originating outside the United States, a legible copy of a rated, 'on-board' commercial ocean bill-of-lading in English for each shipment of cargo described in paragraph (b) (1) of this section to both the Contracting Officer (through the prime contractor in the case of subcontractor bills-of-lading) and to the Division of National Cargo, Office of Market Development, Maritime Administration, Washington, DC 20590.

(3) To insert the substance of the provisions of this clause in all subcontracts issued pursuant to this contract.

**WISCONSIN DEPARTMENT OF TRANSPORTATION  
DIVISION OF TRANSPORTATION AND SYSTEM DEVELOPMENT**

**SUPPLEMENTAL REQUIRED CONTRACT PROVISIONS  
FOR PROJECTS WITH FEDERAL AID**

**I. PREVAILING WAGE RATES**

The attached U.S. Department of Labor (Davis-Bacon Minimum Wage Rates) furnishes the minimum prevailing wage rates pursuant to the Davis-Bacon and Related Acts. The wage rates shown are the minimum rates required by the contract to be paid during its life, however this is not a representation that labor can be obtained at these rates. It is the responsibility of bidders to inform themselves as to the local labor conditions and prospective changes or adjustments of wage rates. No increase in the contract price will be allowed or authorized on account of the payment of wage rates in excess of those listed herein.

**II. COVERAGE OF TRUCK DRIVERS**

Truck drivers are covered by Davis-Bacon Minimum Wage Rates in the following circumstances:

- Drivers of a contractor or subcontractor for time spent working on the site of the work.
- Drivers of a contractor or subcontractor for time spent loading and/or unloading materials and supplies on the site of the work, if such time is not de minimis. [https://www.dol.gov/whd/FOH/FOH\\_Ch15.pdf](https://www.dol.gov/whd/FOH/FOH_Ch15.pdf)
- Truck drivers transporting materials or supplies between a facility that is deemed part of the site of the work and the actual construction site.
- Truck drivers transporting portions of the building or work between a site established specifically for the performance of the contract where a significant portion of such building or work is constructed and the physical place where the building or work called for in the contract will remain.

Truck drivers are not covered by Davis-Bacon Minimum Wage Rates in the following circumstances:

- Material delivery truck drivers while off the site of the work.
- Drivers of a contractor or subcontractor traveling between a Davis-Bacon job and a commercial supply facility while they are off the site of the work.”
- Truck drivers whose time spent on the site of the work is de minimis, such as only a few minutes at a time merely to pick up or drop off materials or supplies.

Details are available online at:

<https://www.dol.gov/whd/recovery/pwrb/Tab9.pdf>

<https://wisconsindot.gov/Pages/doing-bus/civil-rights/labornwage/trckng.aspx>

### **III. POSTINGS AT THE SITE OF THE WORK**

In addition to the required postings furnished by the department, the contractor shall post the following in at least one conspicuous and accessible place at the site of work:

- a. A copy of the contractor's Equal Employment Opportunity Policy.

All required documents shall be posted by the first day of work and be accurate and complete. Postings must be readable, in an area where they will be noticed, and maintained until the last day of work.

### **IV. RESOURCES**

Required information regarding compliance with federal provisions is found in the following resources:

- FHWA-1273 included in this contract
- U.S. Department of Labor Prevailing Wage Resource Book
- U.S. Department of Labor Field Operations Handbook
- U.S. Code of Federal Regulations
- Any applicable law, Act, or Executive Order enacted by the federal government at the time of the letting of this contract

"General Decision Number: WI20210010 07/09/2021

Superseded General Decision Number: WI20200010

State: Wisconsin

Construction Type: Highway

Counties: Wisconsin Statewide.

HIGHWAY, AIRPORT RUNWAY & TAXIWAY CONSTRUCTION PROJECTS (does not include bridges over navigable waters; tunnels; buildings in highway rest areas; and railroad construction)

Note: Under Executive Order (EO) 13658, an hourly minimum wage of \$10.95 for calendar year 2021 applies to all contracts subject to the Davis-Bacon Act for which the contract is awarded (and any solicitation was issued) on or after January 1, 2015. If this contract is covered by the EO, the contractor must pay all workers in any classification listed on this wage determination at least \$10.95 per hour (or the applicable wage rate listed on this wage determination, if it is higher) for all hours spent performing on the contract in calendar year 2021. If this contract is covered by the EO and a classification considered necessary for performance of work on the contract does not appear on this wage determination, the contractor must pay workers in that classification at least the wage rate determined through the conformance process set forth in 29 CFR 5.5(a)(1)(ii) (or the EO minimum wage rate, if it is higher than the conformed wage rate). The EO minimum wage rate will be adjusted annually. Please note that this EO applies to the above-mentioned types of contracts entered into by the federal government that are subject to the Davis-Bacon Act itself, but it does not apply to contracts subject only to the Davis-Bacon Related Acts, including those set forth at 29 CFR 5.1(a)(2)-(60). Additional information on contractor requirements and worker protections under the EO is available at [www.dol.gov/whd/govcontracts](http://www.dol.gov/whd/govcontracts).

Modification Number	Publication Date
0	01/01/2021
1	03/12/2021
2	03/19/2021
3	04/09/2021
4	05/14/2021
5	07/09/2021

BRWI0001-002 06/01/2020

CRAWFORD, JACKSON, JUNEAU, LA CROSSE, MONROE, TREMPPEALEAU, AND VERNON COUNTIES

	Rates	Fringes
BRICKLAYER.....	\$ 35.31	24.7 7
-----		
BRWI0002-002 06/01/2020		

ASHLAND, BAYFIELD, DOUGLAS, AND IRON COUNTIES

	Rates	Fringes
BRICKLAYER.....	\$ 42.77	23.47
-----		
BRWI0002-005 06/01/2020		

ADAMS, ASHLAND, BARRON, BROWN, BURNETT, CALUMET, CHIPPEWA, CLARK, COLUMBIA, DODGE, DOOR, DUNN, FLORENCE, FOND DU LAC, FOREST, GREEN LAKE, IRON, JEFFERSON, KEWAUNEE, LANGLADE, LINCOLN, MANITOWOC, MARATHON, MARINETTE, MARQUETTE, MENOMINEE, OCONTO, ONEIDA, OUTAGAMIE, POLK, PORTAGE, RUSK, ST CROIX, SAUK, SHAWANO, SHEBOYGAN, TAYLOR, VILAS, WALWORTH, WAUPACA, WAUSHARA, WINNEBAGO, AND WOOD COUNTIES

	Rates	Fringes
CEMENT MASON/CONCRETE FINISHER...	\$ 36.68	23.40
-----		
BRWI0003-002 06/01/2020		

BROWN, DOOR, FLORENCE, KEWAUNEE, MARINETTE, AND OCONTO COUNTIES

	Rates	Fringes
BRICKLAYER.....	\$ 35.68	24.40
-----		
BRWI0004-002 06/01/2020		

KENOSHA, RACINE, AND WALWORTH COUNTIES

	Rates	Fringes
BRICKLAYER.....	\$ 39.90	25.53
-----		
BRWI0006-002 06/01/2020		

ADAMS, CLARK, FOREST, LANGLADE, LINCOLN, MARATHON, MENOMINEE,



ONEIDA, PORTAGE, PRICE, TAYLOR, VILAS AND WOOD COUNTIES

	Rates	Fringes
BRICKLAYER.....	\$ 36.60	23.48
-----		
BRWI0007-002 06/01/2020		

GREEN, LAFAYETTE, AND ROCK COUNTIES

	Rates	Fringes
BRICKLAYER.....	\$ 37.07	24.72
-----		
BRWI0008-002 06/01/2020		

MILWAUKEE, OZAUKEE, WASHINGTON, AND WAUKESHA COUNTIES

	Rates	Fringes
BRICKLAYER.....	\$ 40.75	24.32
-----		
BRWI0011-002 06/01/2020		

CALUMET, FOND DU LAC, MANITOWOC, AND SHEBOYGAN COUNTIES

	Rates	Fringes
BRICKLAYER.....	\$ 35.68	24.40
-----		
BRWI0019-002 06/01/2020		

BARRON, BUFFALO, BURNETT, CHIPPEWA, DUNN, EAU CLAIRE, PEPIN,  
PIERCE, POLK, RUSK, ST. CROIX, SAWYER AND WASHBURN COUNTIES

	Rates	Fringes
BRICKLAYER.....	\$ 34.86	25.22
-----		
BRWI0034-002 06/01/2020		

COLUMBIA AND SAUK COUNTIES

	Rates	Fringes
BRICKLAYER.....	\$ 37.36	24.43
-----		
CARP0087-001 05/01/2016		

BURNETT (W. of Hwy 48), PIERCE (W. of Hwy 29), POLK (W. of Hwys 35, 48 & 65), AND ST. CROIX (W. of Hwy 65) COUNTIES

	Rates	Fringes
Carpenter & Piledrivermen.....	\$ 36.85	18.39

-----  
 CARP0252-002 06/01/2016

ADAMS, BARRON, BAYFIELD (Eastern 2/3), BROWN, BUFFALO, BURNETT (E. of Hwy 48), CALUMET, CHIPPEWA, CLARK, COLUMBIA, CRAWFORD, DANE, DODGE, DOOR, DUNN, EAU CLAIRE, FLORENCE (except area bordering Michigan State Line), FOND DU LAC, FOREST, GRANT, GREEN, GREEN LAKE, IOWA, IRON, JACKSON, JEFFERSON, JUNEAU, KEWAUNEE, LA CROSSE, LAFAYETTE, LANGLADE, LINCOLN, MANITOWOC, MARATHON, MARINETTE (except N.E. corner), MARQUETTE, MENOMINEE, MONROE, OCONTO, ONEIDA, OUTAGAMIE, PEPIN, PIERCE (E. of Hwys 29 & 65), POLK (E. of Hwys 35, 48 & 65), PORTAGE, PRICE, RICHLAND, ROCK, RUSK, SAUK, SAWYER, SHAWANO, SHEBOYGAN, ST CROIX (E. of Hwy 65), TAYLOR, TREMPPEALEAU, VERNON, VILAS, WALWORTH, WASHBURN, WAUPACA, WAUSHARA, WINNEBAGO, AND WOOD COUNTIES

	Rates	Fringes
CARPENTER		
CARPENTER.....	\$ 33.56	18.00
MILLWRIGHT.....	\$ 35.08	18.35
PILEDRIVER.....	\$ 34.12	18.00

-----  
 CARP0252-010 06/01/2016

ASHLAND COUNTY

	Rates	Fringes
Carpenters		
Carpenter.....	\$ 33.56	18.00
Millwright.....	\$ 35.08	18.35
Pile Driver.....	\$ 34.12	18.00

-----  
 CARP0264-003 06/01/2016

KENOSHA, MILWAUKEE, OZAUKEE, RACINE, WAUKESHA, AND WASHINGTON COUNTIES

	Rates	Fringes
CARPENTER.....	\$ 35.78	22.11

-----  
 CARP0361-004 05/01/2018

BAYFIELD (West of Hwy 63) AND DOUGLAS COUNTIES

	Rates	Fringes
CARPENTER.....	\$ 36.15	20.43

-----  
 CARP2337-001 06/01/2016

ZONE A: MILWAUKEE, OZAUKEE, WAUKESHA AND WASHINGTON

ZONE B: KENOSHA & RACINE

	Rates	Fringes
PILEDRIVERMAN		
Zone A.....	\$ 31.03	22.69
Zone B.....	\$ 31.03	22.69

-----  
 ELEC0014-002 06/14/2020

ASHLAND, BARRON, BAYFIELD, BUFFALO, BURNETT, CHIPPEWA, CLARK  
 (except Maryville, Colby, Unity, Sherman, Fremont, Lynn &  
 Sherwood), CRAWFORD, DUNN, EAU CLAIRE, GRANT, IRON, JACKSON, LA  
 CROSSE, MONROE, PEPIN, PIERCE, POLK, PRICE, RICHLAND, RUSK, ST  
 CROIX, SAWYER, TAYLOR, TREMPLEAU, VERNON, AND WASHBURN  
 COUNTIES

	Rates	Fringes
Electricians:.....	\$ 35.98	20.98

-----  
 ELEC0014-007 07/05/2020

REMAINING COUNTIES

	Rates	Fringes
Teledata System Installer		
Installer/Technician.....	\$ 27.75	15.14

Low voltage construction, installation, maintenance and  
 removal of teledata facilities (voice, data, and video)

including outside plant, telephone and data inside wire, interconnect, terminal equipment, central offices, PABX, fiber optic cable and equipment, micro waves, V-SAT, bypass, CATV, WAN (wide area networks), LAN (local area networks), and ISDN (integrated systems digital network).

-----  
 ELEC0127-002 06/01/2020

KENOSHA COUNTY

	Rates	Fringes
Electricians:.....	\$ 41.62	30%+12.70

-----  
 ELEC0158-002 06/01/2020

BROWN, DOOR, KEWAUNEE, MANITOWOC (except Schleswig), MARINETTE(Wausaukee and area South thereof), OCONTO, MENOMINEE (East of a line 6 miles West of the West boundary of Oconto County), SHAWANO (Except Area North of Townships of Aniwa and Hutchins) COUNTIES

	Rates	Fringes
ELECTRICIAN.....	\$ 34.77	29.75%+10.26

-----  
 ELEC0159-003 08/02/2020

COLUMBIA, DANE, DODGE (Area West of Hwy 26, except Chester and Emmet Townships), GREEN, LAKE (except Townships of Berlin, Seneca, and St. Marie), IOWA, MARQUETTE (except Townships of Neshkoka, Crystal Lake, Newton, and Springfield), and SAUK COUNTIES

	Rates	Fringes
ELECTRICIAN.....	\$ 41.86	22.67

-----  
 ELEC0219-004 06/01/2019

FLORENCE COUNTY (Townships of Aurora, Commonwealth, Fern, Florence and Homestead) AND MARINETTE COUNTY (Township of Niagara)

	Rates	Fringes
--	-------	---------

Electricians:

Electrical contracts over \$180,000.....	\$ 33.94	21.80
Electrical contracts under \$180,000.....	\$ 31.75	21.73

-----  
ELEC0242-005 05/31/2020

DOUGLAS COUNTY

	Rates	Fringes
Electricians:.....	\$ 39.77	28.11

-----  
ELEC0388-002 06/01/2020

ADAMS, CLARK (Colby, Freemont, Lynn, Mayville, Sherman, Sherwood, Unity), FOREST, JUNEAU, LANGLADE, LINCOLN, MARATHON, MARINETTE (Beecher, Dunbar, Goodman & Pembine), MENOMINEE (Area West of a line 6 miles West of the West boundary of Oconto County), ONEIDA, PORTAGE, SHAWANO (Aniwa and Hutchins), VILAS AND WOOD COUNTIES

	Rates	Fringes
Electricians:.....	\$ 34.85	26%+11.20

-----  
ELEC0430-002 02/02/2021

RACINE COUNTY (Except Burlington Township)

	Rates	Fringes
Electricians:.....	\$ 41.859	22.871

-----  
\* ELEC0494-005 06/01/2021

MILWAUKEE, OZAUKEE, WASHINGTON, AND WAUKESHA COUNTIES

	Rates	Fringes
Electricians:.....	\$ 44.39	25.67

-----  
\* ELEC0494-006 06/01/2021

CALUMET (Township of New Holstein), DODGE (East of Hwy 26 including Chester Township), FOND DU LAC, MANITOWOC (Schleswig), and SHEBOYGAN COUNTIES

	Rates	Fringes
Electricians:.....	\$ 37.91	22.74

-----  
 \* ELEC0494-013 06/01/2021

DODGE (East of Hwy 26 including Chester Twp, excluding Emmet Twp), FOND DU LAC (Except Waupun), MILWAUKEE, OZAUKEE, MANITOWOC (Schleswig), WASHINGTON, AND WAUKESHA COUNTIES

	Rates	Fringes
Sound & Communications		
Installer.....	\$ 22.39	18.80
Technician.....	\$ 32.49	20.26

Installation, testing, maintenance, operation and servicing of all sound, intercom, telephone interconnect, closed circuit TV systems, radio systems, background music systems, language laboratories, electronic carillon, antenna distribution systems, clock and program systems and low-voltage systems such as visual nurse call, audio/visual nurse call systems, doctors entrance register systems. Includes all wire and cable carrying audio, visual, data, light and radio frequency signals. Includes the installation of conduit, wiremold, or raceways in existing structures that have been occupied for six months or more where required for the protection of the wire or cable, but does not mean a complete conduit or raceway system. work covered does not include the installation of conduit, wiremold or any raceways in any new construction, or the installation of power supply outlets by means of which external electric power is supplied to any of the foregoing equipment or products

-----  
 ELEC0577-003 06/01/2020

CALUMET (except Township of New Holstein), GREEN LAKE (N. part including Townships of Berlin, St Marie, and Seneca), MARQUETTE (N. part including Townships of Crystal Lake, Neshkoro, Newton, and Springfield), OUTAGAMIE, WAUPACA, WAUSHARA, AND WINNEBAGO COUNTIES

	Rates	Fringes
Electricians:.....	\$ 34.23	29.50%+10.00

-----  
\* ELEC0890-003 06/01/2021

DODGE (Emmet Township only), GREEN, JEFFERSON, LAFAYETTE,  
RACINE (Burlington Township), ROCK AND WALWORTH COUNTIES

	Rates	Fringes
Electricians:.....	\$ 39.00	25.95%+11.17

-----

ELEC0953-001 06/02/2019

	Rates	Fringes
Line Construction:		
(1) Lineman.....	\$ 47.53	21.43
(2) Heavy Equipment Operator.....	\$ 42.78	19.80
(3) Equipment Operator.....	\$ 38.02	18.40
(4) Heavy Groundman Driver..	\$ 33.27	16.88
(5) Light Groundman Driver..	\$ 30.89	16.11
(6) Groundsman.....	\$ 26.14	14.60

-----

ENGI0139-005 06/01/2020

	Rates	Fringes
Power Equipment Operator		
Group 1.....	\$ 41.62	23.80
Group 2.....	\$ 41.12	23.80
Group 3.....	\$ 40.62	23.80
Group 4.....	\$ 40.36	23.80
Group 5.....	\$ 40.07	23.80
Group 6.....	\$ 34.17	23.80

HAZARDOUS WASTE PREMIUMS:  
EPA Level ""A"" protection - \$3.00 per hour  
EPA Level ""B"" protection - \$2.00 per hour  
EPA Level ""C"" protection - \$1.00 per hour

POWER EQUIPMENT OPERATORS CLASSIFICATIONS

GROUP 1: Cranes, tower cranes, and derricks with or without attachments with a lifting capacity of over 100 tons; or cranes, tower cranes, and derricks with boom, leads and/or jib lengths measuring 176 feet or longer.

GROUP 2: Cranes, tower cranes and derricks with or without attachments with a lifting capacity of 100 tons or less; or

cranes, tower cranes, and derricks with boom, leads, and/or jibs lengths measuring 175 feet or under and Backhoes (excavators) weighing 130,000 lbs and over; caisson rigs; pile driver; dredge operator; dredge engineer; Boat Pilot.

GROUP 3: Mechanic or welder - Heavy duty equipment; cranes with a lifting capacity of 25 tons or under; concrete breaker (manual or remote); vibratory/sonic concrete breaker; concrete laser screed; concrete slipform paver; concrete batch plant operator; concrete pvt. spreader - heavy duty (rubber tired); concrete spreader & distributor; automatic subgrader (concrete); concrete grinder & planing machine; concrete slipform curb & gutter machine; slipform concrete placer; tube finisher; hydro blaster (10,000 psi & over); bridge paver; concrete conveyor system; concrete pump; Rotec type Conveyor; stabilizing mixer (self-propelled); shoulder widener; asphalt plant engineer; bituminous paver; bump cutter & grooving machine; milling machine; screed (bituminous paver); asphalt heater, planer & scarifier; Backhoes (excavators) weighing under 130,000 lbs; grader or motor patrol; tractor (scraper, dozer, pusher, loader); scraper - rubber tired (single or twin engine); endloader; hydraulic backhoe (tractor type); trenching machine; skid rigs; tractor, side boom (heavy); drilling or boring machine (mechanical heavy); roller over 5 tons; percussion or rotary drilling machine; air track; blaster; loading machine (conveyor); tugger; boatmen; winches & A-frames; post driver; material hoist.

GROUP 4: Greaser, roller steel (5 tons or less); roller (pneumatic tired) - self propelled; tractor (mounted or towed compactors & light equipment); shouldering machine; self-propelled chip spreader; concrete spreader; finishing machine; mechanical float; curing machine; power subgrader; joint sawer (multiple blade) belting machine; burlap machine; texturing machine; tractor endloader (rubber tired) - light; jeep digger; forklift; mulcher; launch operator; fireman, environmental burner

GROUP 5: Air compressor; power pack; vibrator hammer and extractor; heavy equipment, leadman; tank car heaters; stump chipper; curb machine operator; Concrete proportioning plants; generators; mudjack operator; rock breaker; crusher or screening plant; screed (milling machine); automatic belt conveyor and surge bin; pug mill operator; Oiler, pump (over 3 inches); Drilling Machine Tender, day light machine

GROUP 6: Off-road material hauler with or without ejector.



-----  
\* IRON0008-002 06/01/2021

BROWN, CALUMET, DOOR, FOND DU LAC, KEWAUNEE, MANITOWOC,  
MARINETTE, OCONTO, OUTAGAMI, SHAWANO, SHEBOYGAN, AND WINNEBAGO  
COUNTIES:

	Rates	Fringes
IRONWORKER.....	\$ 38.77	28.15

Paid Holidays: New Year's Day, Memorial Day, July 4th, Labor  
Day, Thanksgiving Day & Christmas Day.

-----  
\* IRON0008-003 06/01/2021

KENOSHA, MILWAUKEE, OZAUKEE, RACINE, WALWORTH (N.E. 2/3),  
WASHINGTON, AND WAUKESHA COUNTIES

	Rates	Fringes
IRONWORKER.....	\$ 40.57	28.40

Paid Holidays: New Year's Day, Memorial Day, July 4th, Labor  
Day, Thanksgiving Day & Christmas Day.

-----  
\* IRON0383-001 06/06/2021

ADAMS, COLUMBIA, CRAWFORD, DANE, DODGE, FLORENCE, FOREST,  
GRANT, GREENE, (Excluding S.E. tip), GREEN LAKE, IOWA,  
JEFFERSON, JUNEAU, LA CROSSE, LAFAYETTE, LANGLADE, MARATHON,  
MARQUETTE, MENOMINEE, MONROE, PORTAGE, RICHLAND, ROCK (Northern  
area, vicinity of Edgerton and Milton), SAUK, VERNON, WAUPACA,  
WAUSHARA, AND WOOD COUNTIES

	Rates	Fringes
IRONWORKER.....	\$ 37.75	27.06

-----  
IRON0498-005 06/01/2019

GREEN (S.E. 1/3), ROCK (South of Edgerton and Milton), and  
WALWORTH (S.W. 1/3) COUNTIES:

	Rates	Fringes
IRONWORKER.....	\$ 40.25	40.53
-----		
IRON0512-008 06/03/2019		

BARRON, BUFFALO, CHIPPEWA, CLARK, DUNN, EAU CLAIRE, JACKSON, PEPIN, PIERCE, POLK, RUSK, ST CROIX, TAYLOR, AND TREMPPEALEAU COUNTIES

	Rates	Fringes
IRONWORKER.....	\$ 37.60	29.40
-----		
IRON0512-021 05/03/2021		

ASHLAND, BAYFIELD, BURNETT, DOUGLAS, IRON, LINCOLN, ONEIDA, PRICE, SAWYER, VILAS AND WASHBURN COUNTIES

	Rates	Fringes
IRONWORKER.....	\$ 35.09	31.80
-----		
LABO0113-002 06/01/2020		

MILWAUKEE AND WAUKESHA COUNTIES

	Rates	Fringes
LABORER		
Group 1.....	\$ 30.05	22.26
Group 2.....	\$ 30.20	22.26
Group 3.....	\$ 30.40	22.26
Group 4.....	\$ 30.55	22.26
Group 5.....	\$ 30.70	22.26
Group 6.....	\$ 26.54	22.26

LABORERS CLASSIFICATIONS

GROUP 1: General Laborer; Tree Trimmer; Conduit Layer; Demolition and Wrecking Laborer; Guard Rail, Fence, and Bridge Builder; Landscaper; Multiplate Culvert Assembler; Stone Handler; Bituminous Worker (Shoveler, Loader, and Utility Man); Batch Truck Dumper or Cement Handler; Bituminous Worker (Dumper, Ironer, Smoother, and Tamper); Concrete Handler

GROUP 2: Air Tool Operator; Joint Sawyer and Filler

(Pavement); Vibrator or Tamper Operator (Mechanical Hand Operated); Chain Saw Operator; Demolition Burning Torch Laborer

GROUP 3: Bituminous Worker (Raker and Luteman); Formsetter (Curb, Sidewalk, and Pavement); Strike Off Man

GROUP 4: Line and Grade Specialist

GROUP 5: Blaster and Powderman

GROUP 6: Flagperson; traffic control person

-----  
LAB00113-003 06/01/2020

OZAUKEE AND WASHINGTON COUNTIES

	Rates	Fringes
LABORER		
Group 1.....	\$ 29.30	22.26
Group 2.....	\$ 29.40	22.26
Group 3.....	\$ 29.45	22.26
Group 4.....	\$ 29.65	22.26
Group 5.....	\$ 29.50	22.26
Group 6.....	\$ 26.39	22.26

LABORERS CLASSIFICATIONS

GROUP 1: General Laborer; Tree Trimmer; Conduit Layer; Demolition and Wrecking Laborer; Guard Rail, Fence, and Bridge Builder; Landscaper; Multiplate Culvert Assembler; Stone Handler; Bituminous Worker (Shoveler, Loader, and Utility Man); Batch Truck Dumper or Cement Handler; Bituminous Worker (Dumper, Ironer, Smoother, and Tamper); Concrete Handler

GROUP 2: Air Tool Operator; Joint Sawyer and Filler (Pavement); Vibrator or Tamper Operator (Mechanical Hand Operated);

GROUP 3: Bituminous Worker (Raker and Luteman); Formsetter (Curb, Sidewalk, and Pavement); Strike Off Man

GROUP 4: Line and Grade Specialist

GROUP 5: Blaster; powderman

GROUP 6: Flagperson and Traffic Control Person

-----  
LAB00113-011 06/01/2020

KENOSHA AND RACINE COUNTIES

	Rates	Fringes
LABORER		
Group 1.....	\$ 29.11	22.26
Group 2.....	\$ 29.26	22.26
Group 3.....	\$ 29.46	22.26
Group 4.....	\$ 29.43	22.26
Group 5.....	\$ 29.76	22.26
Group 6.....	\$ 26.25	22.26

LABORERS CLASSIFICATIONS:

GROUP 1: General laborer; Tree Trimmer; Conduit Layer; Demolition and Wrecking Laborer; Guard Rail, Fence, and Bridge Builder; Landscaper; Multiplate Culvert Assembler; Stone Handler; Bituminous Worker (Shoveler, Loader, and Utility Man); Batch Truck Dumper or Cement Handler; Bituminous worker (Dumper, Ironer, Smoother, and Tamper); Concrete Handler

GROUP 2: Air Tool Operator; Joint Sawyer and Filler (Pavement); Vibrator or Tamper Operator (Mechanical Hand Operated); Chain Saw Operator; Demolition Burning Torch Laborer

GROUP 3: Bituminous Worker (Raker and Luteman); Formsetter (Curb, Sidewalk, and Pavement); Strike Off Man

GROUP 4: Line and Grade Specialist

GROUP 5: Blaster and Powderman

GROUP 6: Flagman; traffic control person

-----  
LAB00140-002 06/01/2020

ADAMS, ASHLAND, BARRON, BAYFIELD, BROWN, BUFFALO, BURNETT, CALUMET, CHIPPEWA, CLARK, COLUMBIA, CRAWFORD, DODGE, DOOR, DOUGLAS, DUNN, EAU CLAIRE, FLORENCE, FOND DU LAC, FOREST, GRANT, GREEN, GREEN LAKE, IRON, JACKSON, JUNEAU, IOWA, JEFFERSON, KEWAUNEE, LA CROSSE, LAFAYETTE, LANGLADE, LINCOLN, MANITOWOC, MARATHON, MARINETTE, MARQUETTE, MENOMINEE, MONROE, OCONTO, ONEIDA, OUTAGAMIE, PEPIN, PIERCE, POLK, PORTAGE, PRICE,

RICHLAND, ROCK, RUSK, SAUK, SAWYER, SHAWANO, SHEBOYGAN, ST. CROIX, TAYLOR, TREMPLEAU, VERNON, VILLAS, WALWORTH, WASHBURN, WAUPACA, WAUSHARA, WINNEBAGO, AND WOOD COUNTIES

	Rates	Fringes
LABORER		
Group 1.....	\$ 33.72	17.95
Group 2.....	\$ 33.82	17.95
Group 3.....	\$ 33.87	17.95
Group 4.....	\$ 34.07	17.95
Group 5.....	\$ 33.92	17.95
Group 6.....	\$ 30.35	17.95

LABORER CLASSIFICATIONS

GROUP 1: General Laborer; Tree Trimmer; Conduit Layer; Demolition and Wrecking Laborer; Guard Rail, Fence, and Bridge Builder; Landscaper; Multiplate Culvert Assembler; Stone Handler; Bituminous Worker (Shoveler, Loader, and Utility Man); Batch Truck Dumper or Cement Handler; Bituminous Worker (Dumper, Ironer, Smoother and Tamper); Concrete Handler

GROUP 2: Air Tool Operator; Joint Sawyer and Filler (Pavement); Vibrator or Tamper Operator (Mechanical Hand Operated); Chain Saw Operator, Demolition Burning Torch Laborer

GROUP 3: Bituminous Worker (Raker and Luteman); Formsetter (Curb, Sidewalk and Pavement); Strike Off Man

GROUP 4: Line and Grade Specialist

GROUP 5: Blaster; powderman

GROUP 6: Flagperson; Traffic Control

-----  
LAB00464-003 06/01/2020

DANE COUNTY

	Rates	Fringes
LABORER		
Group 1.....	\$ 34.00	17.95
Group 2.....	\$ 34.10	17.95
Group 3.....	\$ 34.15	17.95

Group 4.....	\$ 34.35	17.95
Group 5.....	\$ 34.20	17.95
Group 6.....	\$ 30.35	17.95

LABORERS CLASSIFICATIONS:

GROUP 1: General Laborer; Tree Trimmer; Conduit Layer; Demolition and Wrecking Laborer; Guard Rail, Fence, and Bridge Builder; Landscaper; Multiplate Culvert Assembler; Stone Handler; Bituminous Worker (Shoveler, Loader, and Utility Man); Batch Truck Dumper or Cement Handler; Bituminous Worker (Dumper, Ironer, Smoother, and Tamper); Concrete Handler

GROUP 2: Air Tool Operator; Joint Sawyer and Filler (Pavement); Vibrator or Tamper Operator (Mechanical Hand Operated); Chain Saw Operator; Demolition Burning Torch Laborer

GROUP 3: Bituminous Worker (Raker and Luteman); Formsetter (Curb, Sidewalk, and Pavement); Strike Off Man

GROUP 4: Line and Grade Specialist

GROUP 5: Blaster; Powderman

GROUP 6: Flagperson and Traffic Control Person

-----  
PAIN0106-008 05/01/2017

ASHLAND, BAYFIELD, BURNETT, AND DOUGLAS COUNTIES

	Rates	Fringes
Painters:		
New:		
Brush, Roller.....	\$ 30.33	17.27
Spray, Sandblast, Steel....	\$ 30.93	17.27
Repaint:		
Brush, Roller.....	\$ 28.83	17.27
Spray, Sandblast, Steel....	\$ 29.43	17.27

-----  
PAIN0108-002 06/01/2019

RACINE COUNTY

	Rates	Fringes
--	-------	---------

Painters:

Brush, Roller.....	\$ 36.08	20.36
Spray & Sandblast.....	\$ 37.08	20.36

-----  
PAIN0259-002 05/01/2008

BARRON, CHIPPEWA, DUNN, EAU CLAIRE, PEPIN, PIERCE, POLK, RUSK,  
SAWYER, ST. CROIX, AND WASHBURN COUNTIES

	Rates	Fringes
PAINTER.....	\$ 24.11	12.15

-----  
PAIN0259-004 05/01/2015

BUFFALO, CRAWFORD, JACKSON, LA CROSSE, MONROE, TREMPLEAU, AND  
VERNON COUNTIES

	Rates	Fringes
PAINTER.....	\$ 22.03	12.45

-----  
PAIN0781-002 06/01/2019

JEFFERSON, MILWAUKEE, OZAUKEE, WASHINGTON, AND WAUKESHA COUNTIES

	Rates	Fringes
Painters:		
Bridge.....	\$ 33.30	23.86
Brush.....	\$ 32.95	23.86
Spray & Sandblast.....	\$ 33.70	23.86

-----  
PAIN0802-002 06/01/2019

COLUMBIA, DANE, DODGE, GRANT, GREEN, IOWA, LAFAYETTE, RICHLAND,  
ROCK, AND SAUK COUNTIES

	Rates	Fringes
PAINTER		
Brush.....	\$ 30.93	18.44

PREMIUM PAY:  
Structural Steel, Spray, Bridges = \$1.00 additional per  
hour.

-----

PAIN0802-003 06/01/2019

ADAMS, BROWN, CALUMET, CLARK, DOOR, FOND DU LAC, FOREST, GREEN LAKE, IRON, JUNEAU, KEWAUNEE, LANGLADE, LINCOLN, MANITOWOC, MARATHON, MARINETTE, MARQUETTE, MENOMINEE, OCONTO, ONEIDA, OUTAGAMIE, PORTAGE, PRICE, SHAWANO, SHEBOYGAN, TAYLOR, VILAS, WAUSHARA, WAUPACA, WINNEBAGO, AND WOOD COUNTIES

	Rates	Fringes
PAINTER.....	\$ 30.93	18.58

-----  
PAIN0934-001 06/01/2017

KENOSHA AND WALWORTH COUNTIES

	Rates	Fringes
Painters:		
Brush.....	\$ 33.74	18.95
Spray.....	\$ 34.74	18.95
Structural Steel.....	\$ 33.89	18.95

-----  
PAIN1011-002 06/02/2019

FLORENCE COUNTY

	Rates	Fringes
Painters:.....	\$ 25.76	13.33

-----  
PLAS0599-010 06/01/2017

	Rates	Fringes
CEMENT MASON/CONCRETE FINISHER		
Area 1.....	\$ 39.46	17.17
Area 2 (BAC).....	\$ 35.07	19.75
Area 3.....	\$ 35.61	19.40
Area 4.....	\$ 34.70	20.51
Area 5.....	\$ 36.27	18.73
Area 6.....	\$ 32.02	22.99

AREA DESCRIPTIONS

AREA 1: BAYFIELD, DOUGLAS, PRICE, SAWYER, AND WASHBURN COUNTIES

AREA 2: ADAMS, ASHLAND, BARRON, BROWN, BURNETT, CALUMET,



CHIPPEWA, CLARK, COLUMBIA, DODGE, DOOR, DUNN, FLORENCE,  
 FOND DU LAC, FOREST, GREEN LAKE, IRON, JEFFERSON, KEWAUNEE,  
 LANGLADE, LINCOLN, MANITOWOC, MARATHON, MARINETTE,  
 MARQUETTE, MENOMINEE, OCONTO, ONEIDA, OUTAGAMIE, POLK,  
 PORTAGE, RUSK, ST CROIX, SAUK, SHAWANO, SHEBOYGAN, TAYLOR,  
 VILAS, WALWORTH, WAUPACA, WAUSHARA, WINNEBAGO, AND WOOD  
 COUNTIES

AREA 3: BUFFALO, CRAWFORD, EAU CLAIRE, JACKSON, JUNEAU, LA  
 CROSSE MONROE, PEPIN, PIERCE, RICHLAND, TREMPPEALEAU, AND  
 VERNON COUNTIES

AREA 4: MILWAUKEE, OZAUKEE, WASHINGTON, AND WAUKESHA COUNTIES

AREA 5: DANE, GRANT, GREEN, IOWA, LAFAYETTE, AND ROCK  
 COUNTIES

AREA 6: KENOSHA AND RACINE COUNTIES

-----  
 \* TEAM0039-001 06/01/2021

	Rates	Fringes
TRUCK DRIVER		
1 & 2 Axles.....	\$ 32.57	23.81
3 or more Axles; Euclids, Dumptor & Articulated, Truck Mechanic.....	\$ 32.72	23.81
-----		
WELL DRILLER.....	\$ 16.52	3.70
-----		

WELDERS - Receive rate prescribed for craft performing  
 operation to which welding is incidental.

=====  
 Note: Executive Order (EO) 13706, Establishing Paid Sick Leave  
 for Federal Contractors applies to all contracts subject to the  
 Davis-Bacon Act for which the contract is awarded (and any  
 solicitation was issued) on or after January 1, 2017. If this  
 contract is covered by the EO, the contractor must provide  
 employees with 1 hour of paid sick leave for every 30 hours  
 they work, up to 56 hours of paid sick leave each year.  
 Employees must be permitted to use paid sick leave for their  
 own illness, injury or other health-related needs, including  
 preventive care; to assist a family member (or person who is  
 like family to the employee) who is ill, injured, or has other

health-related needs, including preventive care; or for reasons resulting from, or to assist a family member (or person who is like family to the employee) who is a victim of, domestic violence, sexual assault, or stalking. Additional information on contractor requirements and worker protections under the EO is available at [www.dol.gov/whd/govcontracts](http://www.dol.gov/whd/govcontracts).

Unlisted classifications needed for work not included within the scope of the classifications listed may be added after award only as provided in the labor standards contract clauses (29CFR 5.5 (a) (1) (ii)).

-----

The body of each wage determination lists the classification and wage rates that have been found to be prevailing for the cited type(s) of construction in the area covered by the wage determination. The classifications are listed in alphabetical order of ""identifiers"" that indicate whether the particular rate is a union rate (current union negotiated rate for local), a survey rate (weighted average rate) or a union average rate (weighted union average rate).

#### Union Rate Identifiers

A four letter classification abbreviation identifier enclosed in dotted lines beginning with characters other than ""SU"" or ""UAVG"" denotes that the union classification and rate were prevailing for that classification in the survey. Example: PLUM0198-005 07/01/2014. PLUM is an abbreviation identifier of the union which prevailed in the survey for this classification, which in this example would be Plumbers. 0198 indicates the local union number or district council number where applicable, i.e., Plumbers Local 0198. The next number, 005 in the example, is an internal number used in processing the wage determination. 07/01/2014 is the effective date of the most current negotiated rate, which in this example is July 1, 2014.

Union prevailing wage rates are updated to reflect all rate changes in the collective bargaining agreement (CBA) governing this classification and rate.

#### Survey Rate Identifiers

Classifications listed under the ""SU"" identifier indicate that no one rate prevailed for this classification in the survey and the published rate is derived by computing a weighted average

rate based on all the rates reported in the survey for that classification. As this weighted average rate includes all rates reported in the survey, it may include both union and non-union rates. Example: SULA2012-007 5/13/2014. SU indicates the rates are survey rates based on a weighted average calculation of rates and are not majority rates. LA indicates the State of Louisiana. 2012 is the year of survey on which these classifications and rates are based. The next number, 007 in the example, is an internal number used in producing the wage determination. 5/13/2014 indicates the survey completion date for the classifications and rates under that identifier.

Survey wage rates are not updated and remain in effect until a new survey is conducted.

#### Union Average Rate Identifiers

Classification(s) listed under the UAVG identifier indicate that no single majority rate prevailed for those classifications; however, 100% of the data reported for the classifications was union data. EXAMPLE: UAVG-OH-0010 08/29/2014. UAVG indicates that the rate is a weighted union average rate. OH indicates the state. The next number, 0010 in the example, is an internal number used in producing the wage determination. 08/29/2014 indicates the survey completion date for the classifications and rates under that identifier.

A UAVG rate will be updated once a year, usually in January of each year, to reflect a weighted average of the current negotiated/CBA rate of the union locals from which the rate is based.

---

#### WAGE DETERMINATION APPEALS PROCESS

1.) Has there been an initial decision in the matter? This can be:

- \* an existing published wage determination
- \* a survey underlying a wage determination
- \* a Wage and Hour Division letter setting forth a position on a wage determination matter
- \* a conformance (additional classification and rate) ruling

On survey related matters, initial contact, including requests for summaries of surveys, should be with the Wage and Hour Regional Office for the area in which the survey was conducted

because those Regional Offices have responsibility for the Davis-Bacon survey program. If the response from this initial contact is not satisfactory, then the process described in 2.) and 3.) should be followed.

With regard to any other matter not yet ripe for the formal process described here, initial contact should be with the Branch of Construction Wage Determinations. Write to:

Branch of Construction Wage Determinations  
Wage and Hour Division  
U.S. Department of Labor  
200 Constitution Avenue, N.W.  
Washington, DC 20210

2.) If the answer to the question in 1.) is yes, then an interested party (those affected by the action) can request review and reconsideration from the Wage and Hour Administrator (See 29 CFR Part 1.8 and 29 CFR Part 7). Write to:

Wage and Hour Administrator  
U.S. Department of Labor  
200 Constitution Avenue, N.W.  
Washington, DC 20210

The request should be accompanied by a full statement of the interested party's position and by any information (wage payment data, project description, area practice material, etc.) that the requestor considers relevant to the issue.

3.) If the decision of the Administrator is not favorable, an interested party may appeal directly to the Administrative Review Board (formerly the Wage Appeals Board). Write to:

Administrative Review Board  
U.S. Department of Labor  
200 Constitution Avenue, N.W.  
Washington, DC 20210

4.) All decisions by the Administrative Review Board are final.

=====

END OF GENERAL DECISION"

"General Decision Number: WI20210008 07/09/2021

Superseded General Decision Number: WI20200008

State: Wisconsin

Construction Types: Heavy (Sewer and Water Line and Tunnel)

Counties: Wisconsin Statewide.

TUNNEL, SEWER & WATER LINE CONSTRUCTION PROJECTS

Note: Under Executive Order (EO) 13658, an hourly minimum wage of \$10.95 for calendar year 2021 applies to all contracts subject to the Davis-Bacon Act for which the contract is awarded (and any solicitation was issued) on or after January 1, 2015. If this contract is covered by the EO, the contractor must pay all workers in any classification listed on this wage determination at least \$10.95 per hour (or the applicable wage rate listed on this wage determination, if it is higher) for all hours spent performing on the contract in calendar year 2021. If this contract is covered by the EO and a classification considered necessary for performance of work on the contract does not appear on this wage determination, the contractor must pay workers in that classification at least the wage rate determined through the conformance process set forth in 29 CFR 5.5(a)(1)(ii) (or the EO minimum wage rate, if it is higher than the conformed wage rate). The EO minimum wage rate will be adjusted annually. Please note that this EO applies to the above-mentioned types of contracts entered into by the federal government that are subject to the Davis-Bacon Act itself, but it does not apply to contracts subject only to the Davis-Bacon Related Acts, including those set forth at 29 CFR 5.1(a)(2)-(60). Additional information on contractor requirements and worker protections under the EO is available at [www.dol.gov/whd/govcontracts](http://www.dol.gov/whd/govcontracts).

Modification Number	Publication Date
0	01/01/2021
1	03/12/2021
2	03/19/2021
3	05/14/2021
4	07/09/2021

BRWI0001-002 06/01/2020

CRAWFORD, JACKSON, JUNEAU, LA CROSSE, MONROE, TREMPLEAU, AND VERNON COUNTIES

	Rates	Fringes
BRICKLAYER.....	\$ 35.31	24.7 7
-----		
BRWI0002-002 06/01/2020		

ASHLAND, BAYFIELD, DOUGLAS, AND IRON COUNTIES

	Rates	Fringes
BRICKLAYER.....	\$ 42.77	23.47
-----		
BRWI0002-005 06/01/2020		

ADAMS, ASHLAND, BARRON, BROWN, BURNETT, CALUMET, CHIPPEWA, CLARK, COLUMBIA, DODGE, DOOR, DUNN, FLORENCE, FOND DU LAC, FOREST, GREEN LAKE, IRON, JEFFERSON, KEWAUNEE, LANGLADE, LINCOLN, MANITOWOC, MARATHON, MARINETTE, MARQUETTE, MENOMINEE, OCONTO, ONEIDA, OUTAGAMIE, POLK, PORTAGE, RUSK, ST CROIX, SAUK, SHAWANO, SHEBOYGAN, TAYLOR, VILAS, WALWORTH, WAUPACA, WAUSHARA, WINNEBAGO, AND WOOD COUNTIES

	Rates	Fringes
CEMENT MASON/CONCRETE FINISHER...	\$ 36.68	23.40
-----		
BRWI0003-002 06/01/2020		

BROWN, DOOR, FLORENCE, KEWAUNEE, MARINETTE, AND OCONTO COUNTIES

	Rates	Fringes
BRICKLAYER.....	\$ 35.68	24.40
-----		
BRWI0004-002 06/01/2020		

KENOSHA, RACINE, AND WALWORTH COUNTIES

	Rates	Fringes
BRICKLAYER.....	\$ 39.90	25.53
-----		
BRWI0006-002 06/01/2020		

ADAMS, CLARK, FOREST, LANGLADE, LINCOLN, MARATHON, MENOMINEE, ONEIDA, PORTAGE, PRICE, TAYLOR, VILAS AND WOOD COUNTIES

	Rates	Fringes
BRICKLAYER.....	\$ 36.60	23.48
-----		
BRWI0007-002 06/01/2020		

GREEN, LAFAYETTE, AND ROCK COUNTIES

	Rates	Fringes
BRICKLAYER.....	\$ 37.07	24.72
-----		
BRWI0008-002 06/01/2020		

MILWAUKEE, OZAUKEE, WASHINGTON, AND WAUKESHA COUNTIES

	Rates	Fringes
BRICKLAYER.....	\$ 40.75	24.32
-----		
BRWI0009-001 06/01/2020		

GREEN LAKE, MARQUETTE, OUTAGAMIE, SHAWANO, WAUPACA, WASHARA,  
AND WINNEBAGO COUNTIES

	Rates	Fringes
BRICKLAYER.....	\$ 35.68	24.40
-----		
BRWI0011-002 06/01/2020		

CALUMET, FOND DU LAC, MANITOWOC, AND SHEBOYGAN COUNTIES

	Rates	Fringes
BRICKLAYER.....	\$ 35.68	24.40
-----		
BRWI0013-002 06/03/2019		

DANE, GRANT, IOWA, AND RICHLAND COUNTIES

	Rates	Fringes
BRICKLAYER.....	\$ 35.56	24.23
-----		
BRWI0019-002 06/01/2020		

BARRON, BUFFALO, BURNETT, CHIPPEWA, DUNN, EAU CLAIRE, PEPIN,

PIERCE, POLK, RUSK, ST. CROIX, SAWYER AND WASHBURN COUNTIES

	Rates	Fringes
BRICKLAYER.....	\$ 34.86	25.22
-----		
BRWI0021-002 06/01/2020		

DODGE AND JEFFERSON COUNTIES

	Rates	Fringes
BRICKLAYER.....	\$ 36.80	24.97
-----		
BRWI0034-002 06/01/2020		

COLUMBIA AND SAUK COUNTIES

	Rates	Fringes
BRICKLAYER.....	\$ 37.36	24.43
-----		
CARP0087-001 05/01/2016		

BURNETT (W. of Hwy 48), PIERCE (W. of Hwy 29), POLK (W. of Hwys 35, 48 & 65), AND ST. CROIX (W. of Hwy 65) COUNTIES

	Rates	Fringes
Carpenter & Piledrivermen.....	\$ 36.85	18.39
-----		
CARP0252-002 06/01/2016		

ADAMS, BARRON, BAYFIELD (Eastern 2/3), BROWN, BUFFALO, BURNETT (E. of Hwy 48), CALUMET, CHIPPEWA, CLARK, COLUMBIA, CRAWFORD, DANE, DODGE, DOOR, DUNN, EAU CLAIRE, FLORENCE (except area bordering Michigan State Line), FOND DU LAC, FOREST, GRANT, GREEN, GREEN LAKE, IOWA, IRON, JACKSON, JEFFERSON, JUNEAU, KEWAUNEE, LA CROSSE, LAFAYETTE, LANGLADE, LINCOLN, MANITOWOC, MARATHON, MARINETTE (except N.E. corner), MARQUETTE, MENOMINEE, MONROE, OCONTO, ONEIDA, OUTAGAMIE, PEPIN, PIERCE (E. of Hwys 29 & 65), POLK (E. of Hwys 35, 48 & 65), PORTAGE, PRICE, RICHLAND, ROCK, RUSK, SAUK, SAWYER, SHAWANO, SHEBOYGAN, ST CROIX (E. of Hwy 65), TAYLOR, TREMPLEAU, VERNON, VILAS, WALWORTH, WASHBURN, WAUPACA, WAUSHARA, WINNEBAGO, AND WOOD COUNTIES



	Rates	Fringes
CARPENTER		
CARPENTER.....	\$ 33.56	18.00
MILLWRIGHT.....	\$ 35.08	18.35
PILEDRIVER.....	\$ 34.12	18.00

-----  
 CARP0252-010 06/01/2016

ASHLAND COUNTY

	Rates	Fringes
Carpenters		
Carpenter.....	\$ 33.56	18.00
Millwright.....	\$ 35.08	18.35
Pile Driver.....	\$ 34.12	18.00

-----  
 CARP0264-003 06/01/2016

KENOSHA, MILWAUKEE, OZAUKEE, RACINE, WAUKESHA, AND WASHINGTON COUNTIES

	Rates	Fringes
CARPENTER.....	\$ 35.78	22.11

-----  
 CARP0361-004 05/01/2018

BAYFIELD (West of Hwy 63) AND DOUGLAS COUNTIES

	Rates	Fringes
CARPENTER.....	\$ 36.15	20.43

-----  
 CARP2337-001 06/01/2016

ZONE A: MILWAUKEE, OZAUKEE, WAUKESHA AND WASHINGTON

ZONE B: KENOSHA & RACINE

	Rates	Fringes
PILEDRIVERMAN		
Zone A.....	\$ 31.03	22.69
Zone B.....	\$ 31.03	22.69

-----  
 CARP2337-003 06/01/2019

	Rates	Fringes
MILLWRIGHT		
Zone A.....	\$ 33.58	21.53
Zone B.....	\$ 33.58	21.53

ZONE DEFINITIONS

ZONE A: MILWAUKEE, OZAUKEE, WAUKESHA AND WASHINGTON COUNTIES

ZONE B: KENOSHA & RACINE COUNTIES

-----  
 ELEC0014-002 06/14/2020

ASHLAND, BARRON, BAYFIELD, BUFFALO, BURNETT, CHIPPEWA, CLARK (except Maryville, Colby, Unity, Sherman, Fremont, Lynn & Sherwood), CRAWFORD, DUNN, EAU CLAIRE, GRANT, IRON, JACKSON, LA CROSSE, MONROE, PEPIN, PIERCE, POLK, PRICE, RICHLAND, RUSK, ST CROIX, SAWYER, TAYLOR, TREMPLEAU, VERNON, AND WASHBURN COUNTIES

	Rates	Fringes
Electricians:.....	\$ 35.98	20.98

-----  
 ELEC0127-002 06/01/2020

KENOSHA COUNTY

	Rates	Fringes
Electricians:.....	\$ 41.62	30%+12.70

-----  
 ELEC0158-002 06/01/2020

BROWN, DOOR, KEWAUNEE, MANITOWOC (except Schleswig), MARINETTE(Wausaukee and area South thereof), OCONTO, MENOMINEE (East of a line 6 miles West of the West boundary of Oconto County), SHAWANO (Except Area North of Townships of Aniwa and Hutchins) COUNTIES

	Rates	Fringes
ELECTRICIAN.....	\$ 34.77	29.75%+10.26

-----  
 ELEC0159-003 08/02/2020

COLUMBIA, DANE, DODGE (Area West of Hwy 26, except Chester and Emmet Townships), GREEN, LAKE (except Townships of Berlin, Seneca, and St. Marie), IOWA, MARQUETTE (except Townships of Neshkoka, Crystal Lake, Newton, and Springfield), and SAUK COUNTIES

	Rates	Fringes
ELECTRICIAN.....	\$ 41.86	22.67
-----		
ELEC0219-004 06/01/2019		

FLORENCE COUNTY (Townships of Aurora, Commonwealth, Fern, Florence and Homestead) AND MARINETTE COUNTY (Township of Niagara)

	Rates	Fringes
Electricians:		
Electrical contracts over		
\$180,000.....	\$ 33.94	21.80
Electrical contracts under		
\$180,000.....	\$ 31.75	21.73
-----		
ELEC0242-005 05/31/2020		

DOUGLAS COUNTY

	Rates	Fringes
Electricians:.....	\$ 39.77	28.11
-----		
ELEC0388-002 06/01/2020		

ADAMS, CLARK (Colby, Freemont, Lynn, Mayville, Sherman, Sherwood, Unity), FOREST, JUNEAU, LANGLADE, LINCOLN, MARATHON, MARINETTE (Beecher, Dunbar, Goodman & Pembine), MENOMINEE (Area West of a line 6 miles West of the West boundary of Oconto County), ONEIDA, PORTAGE, SHAWANO (Aniwa and Hutchins), VILAS AND WOOD COUNTIES

	Rates	Fringes
Electricians:.....	\$ 34.85	26%+11.20
-----		
ELEC0430-002 02/02/2021		

RACINE COUNTY (Except Burlington Township)

	Rates	Fringes
Electricians:.....	\$ 41.859	22.871
-----		
* ELEC0494-005 06/01/2021		

MILWAUKEE, OZAUKEE, WASHINGTON, AND WAUKESHA COUNTIES

	Rates	Fringes
Electricians:.....	\$ 44.39	25.67
-----		
* ELEC0494-006 06/01/2021		

CALUMET (Township of New Holstein), DODGE (East of Hwy 26 including Chester Township), FOND DU LAC, MANITOWOC (Schleswig), and SHEBOYGAN COUNTIES

	Rates	Fringes
Electricians:.....	\$ 37.91	22.74
-----		
ELEC0577-003 06/01/2020		

CALUMET (except Township of New Holstein), GREEN LAKE (N. part including Townships of Berlin, St Marie, and Seneca), MARQUETTE (N. part including Townships of Crystal Lake, Neshkoro, Newton, and Springfield), OUTAGAMIE, WAUPACA, WAUSHARA, AND WINNEBAGO COUNTIES

	Rates	Fringes
Electricians:.....	\$ 34.23	29.50%+10.00
-----		
* ELEC0890-003 06/01/2021		

DODGE (Emmet Township only), GREEN, JEFFERSON, LAFAYETTE, RACINE (Burlington Township), ROCK AND WALWORTH COUNTIES

	Rates	Fringes
Electricians:.....	\$ 39.00	25.95%+11.17
-----		
ENGI0139-003 06/01/2020		

REMAINING COUNTIES

	Rates	Fringes
Power Equipment Operator		
Group 1.....	\$ 42.92	23.15
Group 2.....	\$ 41.67	23.15
Group 3.....	\$ 39.97	23.15
Group 4.....	\$ 39.44	23.15
Group 5.....	\$ 37.37	23.15
Group 6.....	\$ 35.84	23.15

HAZARDOUS WASTE PREMIUMS:

EPA Level "A" Protection: \$3.00 per hour  
 EPA Level "B" Protection: \$2.00 per hour  
 EPA Level "C" Protection: \$1.00 per hour

POWER EQUIPMENT OPERATORS CLASSIFICATIONS

GROUP 1: Cranes, Tower Cranes and Derricks with or without attachments with a lifting capacity of over 100 tons; Cranes, Tower Cranes, and Derricks with boom, leads and/or jib lengths 176 ft or longer.

GROUP 2: Backhoes (Excavators) weighing 130,00 lbs and over; Cranes, Tower Cranes and Derricks with or without attachments with a lifting capacity of 100 tons or less; Cranes, Tower Cranes, and Derricks with boom, leads, and/or jib lengths 175 ft or less; Caisson Rigs; Pile Driver

GROUP 3: Backhoes (Excavators) weighing under 130,000 lbs; Travelling Crane (bridge type); Milling Machine; Concrete Paver over 27 E; Concrete Spreader and Distributor; Concrete Laser Screed; Concrete Grinder and Planing Machine; Slipform Curb and Gutter Machine; Boring Machine (Directional); Dredge Operator; Skid Rigs; over 46 meter Concrete Pump.

GROUP 4: Hydraulic Backhoe (tractor or truck mounted); Hydraulic Crane, 10 tons or less; Tractor, Bulldozer, or End Loader (over 40 hp); Motor Patrol; Scraper Operator; Bituminous Plant and Paver Operator; Screed-Milling Machine; Roller over 5 tons; Concrete pumps 46 meter and under; Grout Pumps; Rotec type machine; Hydro Blaster, 10,000 psi and over; Rotary Drill Operator; Percussion Drilling Machine; Air Track Drill with or without integral hammer; Blaster; Boring Machine (vertical or horizontal); Side Boom; Trencher, wheel type or chain type having 8 inch or larger bucket; Rail Leveling Machine (Railroad); Tie

Placer; Tie Extractor; Tie Tamper; Stone Leveler; Straddle Carrier; Material Hoists; Stack Hoist; Man Hoists; Mechanic and Welder; Off Road Material Haulers.

GROUP 5: Tractor, Bulldozer, or Endloader (under 40 hp); Tampers -Compactors, riding type; Stump Chipper, large; Roller, Rubber Tire; Backfiller; Trencher, chain type (bucket under 8 inch); Concrete Auto Breaker, large; Concrete Finishing Machine (road type); Concrete Batch Hopper; Concrete Conveyor Systems; Concrete Mixers, 14S or over; Pumps, Screw Type and Gypsum); Hydrohammers, small; Brooms and Sweepers; Lift Slab Machine; Roller under 5 tons; Industrial Locomotives; Fireman (Pile Drivers and Derricks); Pumps (well points); Hoists, automatic; A-Frames and Winch Trucks; Hoists (tuggers); Boats (Tug, Safety, Work Barges and Launches); Assistant Engineer

GROUP 6: Shouldering Machine Operator; Farm or Industrial Tractor mounted equipment; Post Hole Digger; Auger (vertical and horizontal); Skid Steer Loader with or without attachments; Robotic Tool Carrier with or without attachments; Power Pack Vibratory/Ultra Sound Driver and Extractor; Fireman (Asphalt Plants); Screed Operator; Stone Crushers and Screening Plants; Air, Electric, Hydraulic Jacks (Slip Form); Prestress Machines; Air Compressor, 400 CFM or over; Refrigeration Plant/Freeze Machine; Boiler Operators (temporary heat); Forklifts; Welding Machines; Generators; Pumps over 3"; Heaters, Mechanical; Combination small equipment operator; Winches, small electric; Oiler; Greaser; Rotary Drill Tender; Conveyor; Elevator Operator

-----  
 ENGI0139-007 06/01/2020

DODGE, FOND DU LAC, JEFFERSON, KENOSHA, MILWAUKEE, OZAUKEE, RACINE, SHEBOYGAN, WALWORTH, WASHINGTON, AND WAUKESHA COUNTIES

	Rates	Fringes
Power Equipment Operator		
Group 1.....	\$ 41.64	23.25
Group 2.....	\$ 40.86	23.25
Group 3.....	\$ 39.91	23.25
Group 4.....	\$ 38.86	23.25
Group 5.....	\$ 37.46	23.25

HAZARDOUS WASTE PREMIUMS:  
 EPA Level ""A"" Protection: \$3.00 per hour  
 EPA Level ""B"" Protection: \$2.00 per hour

EPA Level "C" Protection: \$1.00 per hour

#### POWER EQUIPMENT OPERATORS CLASSIFICATIONS

GROUP 1: Cranes, Tower Cranes, and Derricks with or without attachments, with a lifting capacity of over 100 tons; or Cranes, Tower Cranes, and Derricks with boom, leads, and/or jib lengths measuring 176 feet or longer; Backhoes (Excavators) 130,000 lbs and over; Caisson Rigs and Pile Drivers

GROUP 2: Cranes, Tower Cranes and Derricks with or without attachments with a lifting capacity of 100 tons or under; or Cranes, Tower Cranes, and Derricks with boom, lead, and/or jib lengths measuring 175 feet or under; Backhoes (Excavators) under 130,000 lbs; Skid Rigs; Dredge Operator: Traveling Crane (Bridge type); Concrete Paver over 27 E; Concrete Spreader and Distributor; Concrete Pumps and Boring Machines (directional)

GROUP 3: Material Hoists; Stack Hoists; Tractor or Truck mounted Hydraulic Backhoe; Tractor or Truck Mounted Hydraulic Crane, 5 tons or under; Manhoist; Tractor over 40 hp; Bulldozer over 40 hp; Endloader over 40 hp; Forklift, 25 ft and over; Motor Patrol; Scraper Operator; Sideboom; Straddle Carrier; Mechanic and Welder; Bituminous Plant and Paver Operator; Roller over 5 tons; Percussion Drill Operator; Rotary Drill Operator; Blaster; Air Track Drill; Trencher (wheel type or chain type having over 8 inch bucket); Elevator; Milling Machine and Boring Machine (horizontal or vertical); Backhoe Mounted Compactor

GROUP 4: Backfiller; Concrete Auto Breaker (large); Concrete Finishing Machine (road type); Roller, Rubber Tire; Concrete Batch Hopper; Concrete Conveyor System; Concrete Mixers (14S or over); Screw type Pumps and Gypsum Pumps; Grout Pumps; Tractor, Bulldozer, End Loader, under 40 hp; Pumps (well points); Trencher (chain type 8 inch or smaller bucket); Industrial Locomotives; Roller under 5 tons; Fireman (Piledrivers and Derricks); Robotic Tool Carrier with or without attachments.

GROUP 5: Hoists (Automatic); Forklift, 12 ft to 25 ft; Tamper-Compactors, riding type; A-Frame and Winch Trucks; Concrete Auto Breaker; Hydrohammer, small; Brooms and Sweepers; Hoist (Tuggers); Stump Chipper, large; Boats (Tug, Safety, Work Barges and Launch); Shouldering Machine Operator; Screed Operator; Farm or Industrial Tractor; Post Hole Digger; Stone Crushers and Screening Plants; Firemen (Asphalt Plants); Air Compressor (400 CFM or over); Augers

(vertical and horizontal); Generators, 150 KW and over; Air, Electric Hydraulic Jacks (Slipform); Prestress Machines; Skid Steer Loader with or without attachments; Boiler operators (temporary heat); Forklift, 12 ft and under; Screed Operator Milling Machine; Refrigeration Plant/Freeze Machine; Power Pack Vibratory/Ultra Sound Driver and Extractor; Generators under 150 KW; Combination small equipment operator; Compressors under 400 CFM; Welding Machines; Heaters, Mechanical; Pumps; Winches, Small Electric; Oiler and Greaser; Conveyor; High pressure utility locating machine (daylighting machine).

-----  
 \* IRON0008-002 06/01/2021

BROWN, CALUMET, DOOR, FOND DU LAC, KEWAUNEE, MANITOWOC, MARINETTE, OCONTO, OUTAGAMI, SHAWANO, SHEBOYGAN, AND WINNEBAGO COUNTIES:

	Rates	Fringes
IRONWORKER.....	\$ 38.77	28.15

Paid Holidays: New Year's Day, Memorial Day, July 4th, Labor Day, Thanksgiving Day & Christmas Day.

-----  
 \* IRON0008-003 06/01/2021

KENOSHA, MILWAUKEE, OZAUKEE, RACINE, WALWORTH (N.E. 2/3), WASHINGTON, AND WAUKESHA COUNTIES

	Rates	Fringes
IRONWORKER.....	\$ 40.57	28.40

Paid Holidays: New Year's Day, Memorial Day, July 4th, Labor Day, Thanksgiving Day & Christmas Day.

-----  
 \* IRON0383-001 06/06/2021

ADAMS, COLUMBIA, CRAWFORD, DANE, DODGE, FLORENCE, FOREST, GRANT, GREENE, (Excluding S.E. tip), GREEN LAKE, IOWA, JEFFERSON, JUNEAU, LA CROSSE, LAFAYETTE, LANGLADE, MARATHON, MARQUETTE, MENOMINEE, MONROE, PORTAGE, RICHLAND, ROCK (Northern area, vicinity of Edgerton and Milton), SAUK, VERNON, WAUPACA, WAUSHARA, AND WOOD COUNTIES



	Rates	Fringes
IRONWORKER.....	\$ 37.75	27.06
-----		
IRON0498-005 06/01/2019		

GREEN (S.E. 1/3), ROCK (South of Edgerton and Milton), and  
WALWORTH (S.W. 1/3) COUNTIES:

	Rates	Fringes
IRONWORKER.....	\$ 40.25	40.53
-----		
IRON0512-008 06/03/2019		

BARRON, BUFFALO, CHIPPEWA, CLARK, DUNN, EAU CLAIRE, JACKSON,  
PEPIN, PIERCE, POLK, RUSK, ST CROIX, TAYLOR, AND TREMPLEAU  
COUNTIES

	Rates	Fringes
IRONWORKER.....	\$ 37.60	29.40
-----		
IRON0512-021 05/03/2021		

ASHLAND, BAYFIELD, BURNETT, DOUGLAS, IRON, LINCOLN, ONEIDA,  
PRICE, SAWYER, VILAS AND WASHBURN COUNTIES

	Rates	Fringes
IRONWORKER.....	\$ 35.09	31.80
-----		
LAB00113-004 06/01/2020		

MILWAUKEE, OZAUKEE, WASHINGTON, AND WAUKESHA COUNTIES

	Rates	Fringes
Laborers: (Open Cut)		
Group 1.....	\$ 16.38	21.08
Group 2.....	\$ 18.65	21.08
Group 3.....	\$ 22.19	21.08
Group 4.....	\$ 31.56	21.08
Group 5.....	\$ 31.70	21.08
Group 6.....	\$ 31.76	21.08

Group 7.....	\$ 34.77	21.08
Group 8.....	\$ 37.59	21.08
Group 9.....	\$ 38.23	21.08

LABORERS CLASSIFICATIONS [OPEN CUT]

GROUP 1: Yard Laborer

GROUP 2: Landscaper

GROUP 3: Flag Person

GROUP 4: Paving Laborer

GROUP 5: General Laborer on Surface; Top Man

GROUP 6: Mud Mixer

GROUP 7: Mucker; Form Stripper; Bottom Digger and Misc;  
Bottom Man and Welder on Surface

GROUP 8: Concrete Manhole Builder; Caisson Worker; Miner;  
Pipe Layer; Rock Driller and Joint Man; Timber Man and  
Concrete Brusher; Bracer in Trench Behind Machine & Tight  
Sheeting; Concrete Formsetter and Shoveler; Jackhammer  
Operator

GROUP 9: Blaster

-----  
LAB00113-005 06/01/2020

SEWER, TUNNEL & UNDERGROUND

KENOSHA AND RACINE COUNTIES

	Rates	Fringes
Laborers:		
Group 1.....	\$ 23.05	21.08
Group 2.....	\$ 28.98	21.08
Group 3.....	\$ 32.34	21.08
Group 4.....	\$ 34.11	21.08

TUNNEL WORK UNDER COMPRESSED AIR: 0-15 lbs add \$1.00, 15-30  
lbs add \$2.00, over 30 lbs add \$3.00

LABORERS CLASSIFICATIONS

GROUP 1: Flagperson

GROUP 2: Top Man, General Laborer, Wellpoint Installation, Wire Mesh and Reinforcement, Concrete Worker, Form Stripper, Strike-off Work

GROUP 3: Machine and Equipment Operator, Sheeting, Form Setting, Patch Finisher, Bottom Man, Joint Sawyer, Gunnite Man, Manhole Builder, Welder-Torchman, Blaster, Caulker, Bracer, Bull Float, Conduit Worker, Mucker and Car Pusher, Raker and Luteman, Hydraulic Jacking of Shields, Shield Drivers, Mining Machine, Lock Tenders, Mucking Machine Operator, Motor Men & Gauge Tenders and operation of incidental Mechanical Equipment and all Power Driven Tools

GROUP 4: Pipelayer, Miner and Laser Operator

-----

LAB00113-008 06/01/2020

MILWAUKEE, OZAUKEE, WASHINGTON & WAUKESHA COUNTIES

	Rates	Fringes
Laborers: (Tunnel-Free Air)		
Group 1.....	\$ 22.19	21.08
Group 2.....	\$ 31.70	21.08
Group 3.....	\$ 31.76	21.08
Group 4.....	\$ 34.77	21.08
Group 5.....	\$ 34.91	21.08
Group 6.....	\$ 37.59	21.08
Group 7.....	\$ 38.23	21.08

LABORERS CLASSIFICATIONS [TUNNEL - FREE AIR]:

GROUP 1: Flagperson

GROUP 2: General Laborer on surface; Tower Man

GROUP 3: Saw Man; Top Man

GROUP 4: Form Stripper; Car Pusher

GROUP 5: Mucker; Dinkey; Welder (rate on surface)

GROUP 6: Concrete Manhole Builder; Mucking Machine; Miner; Mining Machine; Welder; Rock Driller; Concrete Buster; Jack Hammer Operator; Caisson Worker; Pipelayer and Joint Man; Bracerman

GROUP 7: Blaster

-----  
\* LAB00113-009 06/01/2020

MILWAUKEE, OZAUKEE, WASHINGTON & WAUKESHA COUNTIES

	Rates	Fringes
Laborers: (Tunnel -		
*COMPRESSED AIR 0 - 15 lbs.)		
Group 1.....	\$ 22.19	21.08
Group 2.....	\$ 31.70	21.08
Group 3.....	\$ 35.31	21.08
Group 4.....	\$ 36.11	21.08
Group 5.....	\$ 36.23	21.08
Group 6.....	\$ 38.93	21.08
Group 7.....	\$ 39.55	21.08

LABORERS CLASSIFICATIONS [TUNNEL - COMPRESSED AIR]:

- \*Compressed Air 15 - 30 lbs add \$2.00 to all classifications
- \*Compressed Air over 30 lbs add \$3.00 to all classifications

GROUP 1: Flagperson

GROUP 2: General Laborer on surface

GROUP 3: Lock Tender on surface

GROUP 4: Form Stripper; Car Pusher

GROUP 5: Mucker; Dinkey

GROUP 6: Mucking Machine; Miner; Mining Machine; Welder & Rock Driller; Lock Tender in tunnel; Concrete Buster; Jack Hammer Operator; Caisson Worker; Pielayer and Joint Man; Bracerman; Nozzle Man on Gunite; Timber Man; Concrete Brusher

GROUP 7: Blaster

NOTE: Hazardous & Toxic Waste Removal: add \$0.15 per hour.

-----  
LAB00140-005 06/01/2020

ADAMS, ASHLAND, BARRON, BROWN, BUFFALO, CALUMET, CHIPPEWA, CLARK, COLUMBIA, CRAWFORD, DODGE, DOOR, DUNN, EAU CLAIRE,

FLORENCE, FOND DU LAC, FOREST, GRANT, GREEN, GREEN LAKE, IOWA, JACKSON, JEFFERSON, JUNEAU, LACROSSE, LAFAYETTE, LANGLADE, LINCOLN, MANITOWOC, MARATHON, MARINETTE, MARQUETTE, MENOMINEE, MONROE, OCONTO, ONEIDA, OUTAGAMIE, PEPIN, PIERCE, POLK, PORTAGE, PRICE, RICHLAND, ROCK, RUSK, ST CROIX, SAUK, SAWYER, SHAWANO, SHEBOYGAN, TAYLOR, TREMPPEALEAU, VERNON, VILAS, WALWORTH, WASHBURN, WAUPACA, WAUSHARA, WINNEBAGO, AND WOOD COUNTIES

	Rates	Fringes
LABORER (SEWER & WATER)		
Group 1.....	\$ 29.33	17.88
Group 2.....	\$ 31.18	17.88
Group 3.....	\$ 31.48	17.88
Group 4.....	\$ 32.13	17.88

FOR ALL TUNNEL WORK UNDER COMPRESSED AIR: 0-15 lbs add \$1.00, 15-30 lbs add \$2.00, over 30 lbs add \$3.00

LABORER CLASSIFICATIONS:

GROUP 1: Flagperson

GROUP 2: General Laborer, Wellpoint Installation; Form Stripper; Strike Off worker

GROUP 3: Sheeting Formsetting; Patch Finisher; Bottom Man; Joint Sawyer; Gunnite Man; Manhole Builder; Welder; Torchman; Blaster; Caulker Bracer; Bull Float; Mucker and Car Pusher; Raker and Luteman; Hydraulic jacking of shields, Shield Drivers; Mining Machine; Lock Tenders; Mucking Machine Operators; Motor Men and Gauge Tenders; Power Tool Operators

GROUP 4: Pipelayer, Miner, and Laser Operator

-----  
LAB00464-002 06/01/2020

DANE AND DOUGLAS COUNTIES

	Rates	Fringes
LABORER		
Group 1.....	\$ 29.23	17.88
Group 2.....	\$ 31.43	17.88
Group 3.....	\$ 31.63	17.88
Group 4.....	\$ 32.38	17.88

FOR ALL TUNNEL WORK UNDER COMPRESSED AIR: 0 - 15 lbs add \$1.00, 15- 30 lbs add \$2.00, over 30 lbs add \$3.00

LABORERS CLASSIFICATIONS:

GROUP 1: Flagperson

GROUP 2: General Laborer; Wellpoint Installation; Concrete Worker; Form Stripper; Strike Off worker

GROUP 3: Sheeting Formsetting; Patch Finisher; Bottom Man; Joint Sawyer; Gunnite Man; Manhole Builder; Welder; Torchman; Blaster; Caulker Bracer; Bull Float; Mucker and Car Pusher; Raker and Luteman; Hydraulic jacking of shields, Shield Drivers; Mining Machine; Lock Tenders; Mucking Machine Operators; Motor Men and Gauge Tenders; Power Tool Operators

GROUP 4: Pipelayer, Miner, and Laser Operator

-----  
LAB01091-010 06/01/2020

BAYFIELD, BURNETT, IRON, SAWYER, AND WASHBURN COUNTIES

	Rates	Fringes
Laborers: (SEWER & WATER)		
Group 1.....	\$ 29.02	17.88
Group 2.....	\$ 31.08	17.88
Group 3.....	\$ 31.28	17.88
Group 4.....	\$ 32.03	17.88

FOR ALL TUNNEL WORK UNDER COMPRESSED AIR:  
0 - 15 lbs add \$1.00, 15-30 lbs add \$2.00, over 30 lbs add \$3.00

LABORERS CLASSIFICATIONS:

GROUP 1: Flagperson

GROUP 2: Laborers, Wellpoint Installation; Form Stripper; Strike Off worker

GROUP 3: Sheeting Formsetting; Patch Finisher; Bottom Man; Joint Sawyer; Gunnite Man; Manhole Builder; Welder; Torchman; Blaster; Caulker Bracer; Bull Float; Mucker and

Car Pusher; Raker and Luteman; Hydraulic jacking of shields, Shield Drivers; Mining Machine; Lock Tenders; Mucking Machine Operators; Motor Men and Gauge Tenders; Power Tool Operators

GROUP 4: Pipelayer, Miner, and Laser Operator

-----  
 PLAS0599-010 06/01/2017

	Rates	Fringes
CEMENT MASON/CONCRETE FINISHER		
Area 1.....	\$ 39.46	17.17
Area 2 (BAC).....	\$ 35.07	19.75
Area 3.....	\$ 35.61	19.40
Area 4.....	\$ 34.70	20.51
Area 5.....	\$ 36.27	18.73
Area 6.....	\$ 32.02	22.99

AREA DESCRIPTIONS

AREA 1: BAYFIELD, DOUGLAS, PRICE, SAWYER, AND WASHBURN COUNTIES

AREA 2: ADAMS, ASHLAND, BARRON, BROWN, BURNETT, CALUMET, CHIPPEWA, CLARK, COLUMBIA, DODGE, DOOR, DUNN, FLORENCE, FOND DU LAC, FOREST, GREEN LAKE, IRON, JEFFERSON, KEWAUNEE, LANGLADE, LINCOLN, MANITOWOC, MARATHON, MARINETTE, MARQUETTE, MENOMINEE, OCONTO, ONEIDA, OUTAGAMIE, POLK, PORTAGE, RUSK, ST CROIX, SAUK, SHAWANO, SHEBOYGAN, TAYLOR, VILAS, WALWORTH, WAUPACA, WAUSHARA, WINNEBAGO, AND WOOD COUNTIES

AREA 3: BUFFALO, CRAWFORD, EAU CLAIRE, JACKSON, JUNEAU, LA CROSSE MONROE, PEPIN, PIERCE, RICHLAND, TREMPLEAU, AND VERNON COUNTIES

AREA 4: MILWAUKEE, OZAUKEE, WASHINGTON, AND WAUKESHA COUNTIES

AREA 5: DANE, GRANT, GREEN, IOWA, LAFAYETTE, AND ROCK COUNTIES

AREA 6: KENOSHA AND RACINE COUNTIES

-----  
 \* TEAM0039-001 06/01/2021

Rates	Fringes
-------	---------

TRUCK DRIVER		
1 & 2 Axles.....	\$ 32.57	23.81
3 or more Axles; Euclids, Dumptor & Articulated, Truck Mechanic.....	\$ 32.72	23.81
-----		
WELL DRILLER.....	\$ 16.52	3.70
-----		

WELDERS - Receive rate prescribed for craft performing operation to which welding is incidental.

=====

Note: Executive Order (EO) 13706, Establishing Paid Sick Leave for Federal Contractors applies to all contracts subject to the Davis-Bacon Act for which the contract is awarded (and any solicitation was issued) on or after January 1, 2017. If this contract is covered by the EO, the contractor must provide employees with 1 hour of paid sick leave for every 30 hours they work, up to 56 hours of paid sick leave each year. Employees must be permitted to use paid sick leave for their own illness, injury or other health-related needs, including preventive care; to assist a family member (or person who is like family to the employee) who is ill, injured, or has other health-related needs, including preventive care; or for reasons resulting from, or to assist a family member (or person who is like family to the employee) who is a victim of, domestic violence, sexual assault, or stalking. Additional information on contractor requirements and worker protections under the EO is available at [www.dol.gov/whd/govcontracts](http://www.dol.gov/whd/govcontracts).

Unlisted classifications needed for work not included within the scope of the classifications listed may be added after award only as provided in the labor standards contract clauses (29CFR 5.5 (a) (1) (ii)).

-----

The body of each wage determination lists the classification and wage rates that have been found to be prevailing for the cited type(s) of construction in the area covered by the wage determination. The classifications are listed in alphabetical order of ""identifiers"" that indicate whether the particular rate is a union rate (current union negotiated rate for local), a survey rate (weighted average rate) or a union average rate (weighted union average rate).



## Union Rate Identifiers

A four letter classification abbreviation identifier enclosed in dotted lines beginning with characters other than ""SU"" or ""UAVG"" denotes that the union classification and rate were prevailing for that classification in the survey. Example: PLUM0198-005 07/01/2014. PLUM is an abbreviation identifier of the union which prevailed in the survey for this classification, which in this example would be Plumbers. 0198 indicates the local union number or district council number where applicable, i.e., Plumbers Local 0198. The next number, 005 in the example, is an internal number used in processing the wage determination. 07/01/2014 is the effective date of the most current negotiated rate, which in this example is July 1, 2014.

Union prevailing wage rates are updated to reflect all rate changes in the collective bargaining agreement (CBA) governing this classification and rate.

## Survey Rate Identifiers

Classifications listed under the ""SU"" identifier indicate that no one rate prevailed for this classification in the survey and the published rate is derived by computing a weighted average rate based on all the rates reported in the survey for that classification. As this weighted average rate includes all rates reported in the survey, it may include both union and non-union rates. Example: SULA2012-007 5/13/2014. SU indicates the rates are survey rates based on a weighted average calculation of rates and are not majority rates. LA indicates the State of Louisiana. 2012 is the year of survey on which these classifications and rates are based. The next number, 007 in the example, is an internal number used in producing the wage determination. 5/13/2014 indicates the survey completion date for the classifications and rates under that identifier.

Survey wage rates are not updated and remain in effect until a new survey is conducted.

## Union Average Rate Identifiers

Classification(s) listed under the UAVG identifier indicate that no single majority rate prevailed for those classifications; however, 100% of the data reported for the classifications was union data. EXAMPLE: UAVG-OH-0010 08/29/2014. UAVG indicates that the rate is a weighted union average rate. OH indicates the state. The next number, 0010 in the example, is an internal number used in producing the wage

determination. 08/29/2014 indicates the survey completion date for the classifications and rates under that identifier.

A UAVG rate will be updated once a year, usually in January of each year, to reflect a weighted average of the current negotiated/CBA rate of the union locals from which the rate is based.

-----  
WAGE DETERMINATION APPEALS PROCESS

1.) Has there been an initial decision in the matter? This can be:

- \* an existing published wage determination
- \* a survey underlying a wage determination
- \* a Wage and Hour Division letter setting forth a position on a wage determination matter
- \* a conformance (additional classification and rate) ruling

On survey related matters, initial contact, including requests for summaries of surveys, should be with the Wage and Hour Regional Office for the area in which the survey was conducted because those Regional Offices have responsibility for the Davis-Bacon survey program. If the response from this initial contact is not satisfactory, then the process described in 2.) and 3.) should be followed.

With regard to any other matter not yet ripe for the formal process described here, initial contact should be with the Branch of Construction Wage Determinations. Write to:

Branch of Construction Wage Determinations  
Wage and Hour Division  
U.S. Department of Labor  
200 Constitution Avenue, N.W.  
Washington, DC 20210

2.) If the answer to the question in 1.) is yes, then an interested party (those affected by the action) can request review and reconsideration from the Wage and Hour Administrator (See 29 CFR Part 1.8 and 29 CFR Part 7). Write to:

Wage and Hour Administrator  
U.S. Department of Labor  
200 Constitution Avenue, N.W.  
Washington, DC 20210

The request should be accompanied by a full statement of the interested party's position and by any information (wage payment data, project description, area practice material, etc.) that the requestor considers relevant to the issue.

3.) If the decision of the Administrator is not favorable, an interested party may appeal directly to the Administrative Review Board (formerly the Wage Appeals Board). Write to:

Administrative Review Board  
U.S. Department of Labor  
200 Constitution Avenue, N.W.  
Washington, DC 20210

4.) All decisions by the Administrative Review Board are final.

=====

END OF GENERAL DECISION"

**August 2018**

**NOTICE TO BIDDERS  
WAGE RATE DECISION**

The wage rate decision of the Department of Labor which has been incorporated in these advertised specifications is incomplete in that the classifications may be omitted from the Department of Labor's decision.

Since the bidder is responsible, independently, for ascertaining area practice with respect to the necessity, or lack of necessity, for the use of these classifications in the prosecution of the work contemplated by this project, no inference may be drawn from the omission of these classifications concerning prevailing area practices relative to their use. Further, this omission will not, per se, be construed as establishing any governmental liability for increased labor cost if it is subsequently determined that such classifications are required.

There may be omissions and/or errors in the federal wage rates. The bidder is responsible for evaluating and determining the correct applicable rate.

If a project includes multiple types of construction (highway, bridge over navigable water, sanitary sewer and water main, building) and there is not a separate wage determination for this type of work included in the proposal, use the wage determination that is in the proposal.

If a project includes multiple types of construction, different wage rate determinations may be inserted into the contract (WI10/Highway = in all WisDOT highway contracts, WI15/Heavy = bridge over navigable water per USDOL and US Coast Guard designation, WI8/Heavy (Sewer & Water Line & Tunnel) = sanitary sewer and water main if the cost is more than 20% of the contract and/or at least \$1,000,000, and Building). If multiple wage rate determinations are inserted into the contract, use the classification in the wage determination for the work being done. Use WI15 wage rates when working on the bridge and/or structure from bank to bank. Use WI8 wage rates when working on any sanitary sewer or water main work. Use Building wage rates for all work done within the footprint of the building. Use WI10 wage rates for all other highway work in the contract and approaches to structures. For example, if a laborer is working within the footprint of a building, use the Laborer rate in the Building wage determination inserted in the contract. If a laborer is working on a bridge/structure within the banks, use the Laborer rate in the WI15/Heavy wage determination if inserted in the contract. If the laborer is working on the highway, use the Laborer rate in the WI10/Highway wage determination.



## Proposal Schedule of Items

Proposal ID: 20211214021 Project(s): 6995-00-13, 6995-00-14

Federal ID(s): WISC 2022081, N/A

SECTION: 0001

Roadway Items

Alt Set ID:

Alt Mbr ID:

Proposal Line Number	Item ID Description	Approximate Quantity and Units	Unit Price	Bid Amount
0002	201.0120 Clearing	114.000 ID	_____	_____
0004	201.0220 Grubbing	114.000 ID	_____	_____
0006	204.0100 Removing Concrete Pavement	9,613.000 SY	_____	_____
0008	204.0150 Removing Curb & Gutter	85.000 LF	_____	_____
0010	204.0155 Removing Concrete Sidewalk	2,115.000 SY	_____	_____
0012	204.0210 Removing Manholes	5.000 EACH	_____	_____
0014	204.0220 Removing Inlets	14.000 EACH	_____	_____
0016	204.0245 Removing Storm Sewer (size) 01. 12-Inch or Less	295.000 LF	_____	_____
0018	204.0245 Removing Storm Sewer (size) 02. 15-Inch	231.000 LF	_____	_____
0020	204.0245 Removing Storm Sewer (size) 03. 18-Inch	10.000 LF	_____	_____
0022	204.0245 Removing Storm Sewer (size) 04. 21-Inch	414.000 LF	_____	_____
0024	204.0245 Removing Storm Sewer (size) 05. 24-Inch	207.000 LF	_____	_____
0026	204.0245 Removing Storm Sewer (size) 06. 36-Inch	95.000 LF	_____	_____
0028	204.0280 Sealing Pipes	2.000 EACH	_____	_____
0030	205.0100 Excavation Common	7,720.000 CY	_____	_____



## Proposal Schedule of Items

Proposal ID: 20211214021 Project(s): 6995-00-13, 6995-00-14

Federal ID(s): WISC 2022081, N/A

SECTION: 0001

Roadway Items

Alt Set ID:

Alt Mbr ID:

Proposal Line Number	Item ID Description	Approximate Quantity and Units	Unit Price	Bid Amount
0032	213.0100 Finishing Roadway (project) 01. 6995-00-13	1.000 EACH	_____.	_____.
0034	305.0110 Base Aggregate Dense 3/4-Inch	16.000 TON	_____.	_____.
0036	305.0120 Base Aggregate Dense 1 1/4-Inch	4,180.000 TON	_____.	_____.
0038	310.0115 Base Aggregate Open-Graded	10.000 CY	_____.	_____.
0040	311.0110 Breaker Run	5,800.000 TON	_____.	_____.
0042	415.0080 Concrete Pavement 8-Inch	7,465.000 SY	_____.	_____.
0044	415.1080 Concrete Pavement HES 8-Inch	185.000 SY	_____.	_____.
0046	416.0160 Concrete Driveway 6-Inch	512.000 SY	_____.	_____.
0048	416.0260 Concrete Driveway HES 6-Inch	27.000 SY	_____.	_____.
0050	416.0610 Drilled Tie Bars	46.000 EACH	_____.	_____.
0052	416.0620 Drilled Dowel Bars	167.000 EACH	_____.	_____.
0054	455.0605 Tack Coat	3.000 GAL	_____.	_____.
0056	465.0105 Asphaltic Surface	13.000 TON	_____.	_____.
0058	465.0120 Asphaltic Surface Driveways and Field Entrances	16.000 TON	_____.	_____.
0060	520.8000 Concrete Collars for Pipe	6.000 EACH	_____.	_____.
0062	601.0409 Concrete Curb & Gutter 30-Inch Type A	525.000 LF	_____.	_____.



## Proposal Schedule of Items

Proposal ID: 20211214021 Project(s): 6995-00-13, 6995-00-14

Federal ID(s): WISC 2022081, N/A

SECTION: 0001

Roadway Items

Alt Set ID:

Alt Mbr ID:

Proposal Line Number	Item ID Description	Approximate Quantity and Units	Unit Price	Bid Amount
0064	601.0411 Concrete Curb & Gutter 30-Inch Type D	10.000 LF	_____.	_____.
0066	601.0452 Concrete Curb & Gutter Integral 30-Inch Type D	4,020.000 LF	_____.	_____.
0068	601.0600 Concrete Curb Pedestrian	350.000 LF	_____.	_____.
0070	602.0405 Concrete Sidewalk 4-Inch	19,480.000 SF	_____.	_____.
0072	602.0415 Concrete Sidewalk 6-Inch	4,195.000 SF	_____.	_____.
0074	602.0505 Curb Ramp Detectable Warning Field Yellow	260.000 SF	_____.	_____.
0076	608.0412 Storm Sewer Pipe Reinforced Concrete Class IV 12-Inch	163.000 LF	_____.	_____.
0078	608.0415 Storm Sewer Pipe Reinforced Concrete Class IV 15-Inch	20.000 LF	_____.	_____.
0080	608.0418 Storm Sewer Pipe Reinforced Concrete Class IV 18-Inch	57.000 LF	_____.	_____.
0082	608.0424 Storm Sewer Pipe Reinforced Concrete Class IV 24-Inch	233.000 LF	_____.	_____.
0084	608.0430 Storm Sewer Pipe Reinforced Concrete Class IV 30-Inch	261.000 LF	_____.	_____.
0086	608.3012 Storm Sewer Pipe Class III-A 12-Inch	155.000 LF	_____.	_____.
0088	608.3015 Storm Sewer Pipe Class III-A 15-Inch	8.000 LF	_____.	_____.
0090	608.3018 Storm Sewer Pipe Class III-A 18-Inch	292.000 LF	_____.	_____.
0092	608.3030 Storm Sewer Pipe Class III-A 30-Inch	167.000 LF	_____.	_____.



Proposal Schedule of Items

Proposal ID: 20211214021 Project(s): 6995-00-13, 6995-00-14

Federal ID(s): WISC 2022081, N/A

SECTION: 0001 Roadway Items

Alt Set ID: Alt Mbr ID:

Proposal Line Number	Item ID Description	Approximate Quantity and Units	Unit Price	Bid Amount
0094	608.3036 Storm Sewer Pipe Class III-A 36-Inch	94.000 LF	_____.	_____.
0096	608.6010 Storm Sewer Pipe Composite 10-Inch	13.000 LF	_____.	_____.
0098	611.0530 Manhole Covers Type J	10.000 EACH	_____.	_____.
0100	611.0624 Inlet Covers Type H	27.000 EACH	_____.	_____.
0102	611.2004 Manholes 4-FT Diameter	2.000 EACH	_____.	_____.
0104	611.2005 Manholes 5-FT Diameter	6.000 EACH	_____.	_____.
0106	611.2006 Manholes 6-FT Diameter	3.000 EACH	_____.	_____.
0108	611.3004 Inlets 4-FT Diameter	3.000 EACH	_____.	_____.
0110	611.3230 Inlets 2x3-FT	26.000 EACH	_____.	_____.
0112	611.8110 Adjusting Manhole Covers	2.000 EACH	_____.	_____.
0114	611.8115 Adjusting Inlet Covers	1.000 EACH	_____.	_____.
0116	612.0106 Pipe Underdrain 6-Inch	254.000 LF	_____.	_____.
0118	612.0902.S Insulation Board Polystyrene (inch) 01. 2-Inch	162.560 SY	_____.	_____.
0120	618.0100 Maintenance And Repair of Haul Roads (project) 01. 6995-00-13	1.000 EACH	_____.	_____.
0122	619.1000 Mobilization	1.000 EACH	_____.	_____.
0124	624.0100 Water	46.000 MGAL	_____.	_____.





Proposal Schedule of Items

Proposal ID: 20211214021 Project(s): 6995-00-13, 6995-00-14

Federal ID(s): WISC 2022081, N/A

SECTION: 0001 Roadway Items

Alt Set ID: Alt Mbr ID:

Proposal Line Number	Item ID Description	Approximate Quantity and Units	Unit Price	Bid Amount
0126	625.0100 Topsoil	2,200.000 SY	_____.	_____.
0128	628.1905 Mobilizations Erosion Control	12.000 EACH	_____.	_____.
0130	628.1910 Mobilizations Emergency Erosion Control	6.000 EACH	_____.	_____.
0132	628.7005 Inlet Protection Type A	1.000 EACH	_____.	_____.
0134	628.7020 Inlet Protection Type D	58.000 EACH	_____.	_____.
0136	628.7560 Tracking Pads	4.000 EACH	_____.	_____.
0138	629.0210 Fertilizer Type B	1.400 CWT	_____.	_____.
0140	631.0300 Sod Water	125.000 MGAL	_____.	_____.
0142	631.1000 Sod Lawn	2,200.000 SY	_____.	_____.
0144	634.0812 Posts Tubular Steel 2x2-Inch X 12-FT	4.000 EACH	_____.	_____.
0146	634.0814 Posts Tubular Steel 2x2-Inch X 14-FT	26.000 EACH	_____.	_____.
0148	634.0816 Posts Tubular Steel 2x2-Inch X 16-FT	2.000 EACH	_____.	_____.
0150	637.2210 Signs Type II Reflective H	79.830 SF	_____.	_____.
0152	637.2220 Signs Type II Reflective SH	13.240 SF	_____.	_____.
0154	637.2230 Signs Type II Reflective F	37.750 SF	_____.	_____.
0156	638.2602 Removing Signs Type II	28.000 EACH	_____.	_____.
0158	638.3000 Removing Small Sign Supports	27.000 EACH	_____.	_____.



Proposal Schedule of Items

Proposal ID: 20211214021 Project(s): 6995-00-13, 6995-00-14

Federal ID(s): WISC 2022081, N/A

SECTION: 0001 Roadway Items

Alt Set ID: Alt Mbr ID:

Proposal Line Number	Item ID Description	Approximate Quantity and Units	Unit Price	Bid Amount
0160	642.5001 Field Office Type B	1.000 EACH	_____.	_____.
0162	643.0300 Traffic Control Drums	4,000.000 DAY	_____.	_____.
0164	643.0410 Traffic Control Barricades Type II	3,024.000 DAY	_____.	_____.
0166	643.0420 Traffic Control Barricades Type III	5,160.000 DAY	_____.	_____.
0168	643.0705 Traffic Control Warning Lights Type A	10,596.000 DAY	_____.	_____.
0170	643.0715 Traffic Control Warning Lights Type C	4,000.000 DAY	_____.	_____.
0172	643.0900 Traffic Control Signs	16,586.000 DAY	_____.	_____.
0174	643.1000 Traffic Control Signs Fixed Message	84.000 SF	_____.	_____.
0176	643.1050 Traffic Control Signs PCMS	7.000 DAY	_____.	_____.
0178	643.5000 Traffic Control	1.000 EACH	_____.	_____.
0180	644.1410 Temporary Pedestrian Surface Asphalt	800.000 SF	_____.	_____.
0182	644.1420 Temporary Pedestrian Surface Plywood	800.000 SF	_____.	_____.
0184	644.1430 Temporary Pedestrian Surface Plate	800.000 SF	_____.	_____.
0186	644.1601 Temporary Pedestrian Curb Ramp	5,000.000 DAY	_____.	_____.
0188	644.1810 Temporary Pedestrian Barricade	1,500.000 LF	_____.	_____.
0190	645.0111 Geotextile Type DF Schedule A	141.000 SY	_____.	_____.
0192	645.0220 Geogrid Type SR	9,965.000 SY	_____.	_____.



Proposal Schedule of Items

Proposal ID: 20211214021 Project(s): 6995-00-13, 6995-00-14

Federal ID(s): WISC 2022081, N/A

SECTION: 0001 Roadway Items

Alt Set ID: Alt Mbr ID:

Proposal Line Number	Item ID Description	Approximate Quantity and Units	Unit Price	Bid Amount
0194	646.1020 Marking Line Epoxy 4-Inch	550.000 LF	_____.	_____.
0196	646.6120 Marking Stop Line Epoxy 18-Inch	105.000 LF	_____.	_____.
0198	646.7420 Marking Crosswalk Epoxy Transverse Line 6-Inch	820.000 LF	_____.	_____.
0200	646.7520 Marking Crosswalk Epoxy Block Style 24-Inch	96.000 LF	_____.	_____.
0202	649.0150 Temporary Marking Line Removable Tape 4-Inch	500.000 LF	_____.	_____.
0204	650.4000 Construction Staking Storm Sewer	40.000 EACH	_____.	_____.
0206	650.4500 Construction Staking Subgrade	2,211.000 LF	_____.	_____.
0208	650.5500 Construction Staking Curb Gutter and Curb & Gutter	885.000 LF	_____.	_____.
0210	650.7000 Construction Staking Concrete Pavement	2,211.000 LF	_____.	_____.
0212	650.8500 Construction Staking Electrical Installations (project) 01. 6995-00-13	LS	LUMP SUM	_____.
0214	650.9000 Construction Staking Curb Ramps	26.000 EACH	_____.	_____.
0216	650.9910 Construction Staking Supplemental Control (project) 01. 6995-00-13	LS	LUMP SUM	_____.
0218	650.9920 Construction Staking Slope Stakes	2,211.000 LF	_____.	_____.
0220	652.0225 Conduit Rigid Nonmetallic Schedule 40 2-Inch	41.000 LF	_____.	_____.
0222	653.0135 Pull Boxes Steel 24x36-Inch	2.000 EACH	_____.	_____.



Proposal Schedule of Items

Proposal ID: 20211214021 Project(s): 6995-00-13, 6995-00-14

Federal ID(s): WISC 2022081, N/A

SECTION: 0001 Roadway Items

Alt Set ID: Alt Mbr ID:

Proposal Line Number	Item ID Description	Approximate Quantity and Units	Unit Price	Bid Amount
0224	690.0150 Sawing Asphalt	246.000 LF	_____	_____
0226	690.0250 Sawing Concrete	988.000 LF	_____	_____
0228	715.0720 Incentive Compressive Strength Concrete Pavement	2,295.000 DOL	1.00000	2,295.00
0230	740.0440 Incentive IRI Ride	1,675.000 DOL	1.00000	1,675.00
0232	ASP.1T0A On-the-Job Training Apprentice at \$5.00/HR	2,000.000 HRS	5.00000	10,000.00
0234	ASP.1T0G On-the-Job Training Graduate at \$5.00/HR	1,200.000 HRS	5.00000	6,000.00
0236	SPV.0060 Special 01. Reconnect Storm Sewer Laterals	4.000 EACH	_____	_____
0238	SPV.0060 Special 02. Concrete Pipe Support	2.000 EACH	_____	_____
0240	SPV.0060 Special 03. Remove Ex. Sanitary Manhole	6.000 EACH	_____	_____
0242	SPV.0060 Special 04. Remove Ex. Sanitary Vault Structure	1.000 EACH	_____	_____
0244	SPV.0060 Special 05. Remove Ex. Water Valve Box	14.000 EACH	_____	_____
0246	SPV.0060 Special 06. Remove Ex. Hydrant	6.000 EACH	_____	_____
0248	SPV.0060 Special 07. Adjust Ex. Water Valve Box	4.000 EACH	_____	_____
0250	SPV.0060 Special 08. Adjust Ex. Curb Stop Box	1.000 EACH	_____	_____
0252	SPV.0060 Special 09. Sanitary Manhole (48 Inch)	3.000 EACH	_____	_____



Proposal Schedule of Items

Proposal ID: 20211214021 Project(s): 6995-00-13, 6995-00-14

Federal ID(s): WISC 2022081, N/A

SECTION: 0001 Roadway Items

Alt Set ID: Alt Mbr ID:

Proposal Line Number	Item ID Description	Approximate Quantity and Units	Unit Price	Bid Amount
0254	SPV.0060 Special 10. Sanitary Manhole (60 Inch)	2.000 EACH	_____.	_____.
0256	SPV.0060 Special 11. Sanitary Drop Manhole (48 Inch)	1.000 EACH	_____.	_____.
0258	SPV.0060 Special 12. Sanitary Drop Manhole (60 Inch)	1.000 EACH	_____.	_____.
0260	SPV.0060 Special 13. Sanitary MH Cover Type J-Special	7.000 EACH	_____.	_____.
0262	SPV.0060 Special 14. Connect to Existing Sanitary Sewer	6.000 EACH	_____.	_____.
0264	SPV.0060 Special 15. Sanitary WYE 30-Inch Main	17.000 EACH	_____.	_____.
0266	SPV.0060 Special 16. Sanitary WYE 24-Inch Main	41.000 EACH	_____.	_____.
0268	SPV.0060 Special 17. Sanitary Lateral Reconnection	58.000 EACH	_____.	_____.
0270	SPV.0060 Special 18. Water Valve & Box 6-Inch	6.000 EACH	_____.	_____.
0272	SPV.0060 Special 19. Water Valve & Box 8-Inch	12.000 EACH	_____.	_____.
0274	SPV.0060 Special 20. Water Valve & Box 10-Inch	2.000 EACH	_____.	_____.
0276	SPV.0060 Special 21. Fire Hydrant	6.000 EACH	_____.	_____.
0278	SPV.0060 Special 22. Cross 8"x8" Special	1.000 EACH	_____.	_____.
0280	SPV.0060 Special 23. Tees 8"x6"x8" Special	6.000 EACH	_____.	_____.
0282	SPV.0060 Special 24. Tees 8"x8"x8" Special	2.000 EACH	_____.	_____.



Proposal Schedule of Items

Proposal ID: 20211214021 Project(s): 6995-00-13, 6995-00-14

Federal ID(s): WISC 2022081, N/A

SECTION: 0001 Roadway Items

Alt Set ID: Alt Mbr ID:

Proposal Line Number	Item ID Description	Approximate Quantity and Units	Unit Price	Bid Amount
0284	SPV.0060 Special 25. Tees 10"x6"x10" Special	1.000 EACH	_____.	_____.
0286	SPV.0060 Special 26. Tees 10"x10"x10" Special	2.000 EACH	_____.	_____.
0288	SPV.0060 Special 27. Bend 11.25-Degree 8-Inch Special	3.000 EACH	_____.	_____.
0290	SPV.0060 Special 28. Bend 11.25-Degree 10-Inch Special	1.000 EACH	_____.	_____.
0292	SPV.0060 Special 29. Bend 45-Degree 4-Inch Special	4.000 EACH	_____.	_____.
0294	SPV.0060 Special 30. Bend 45-Degree 6-Inch Special	6.000 EACH	_____.	_____.
0296	SPV.0060 Special 31. Bend 45-Degree 8-Inch Special	4.000 EACH	_____.	_____.
0298	SPV.0060 Special 32. Bend 45-Degree 10-Inch Special	4.000 EACH	_____.	_____.
0300	SPV.0060 Special 33. Bend 90-Degree 6-Inch Special	1.000 EACH	_____.	_____.
0302	SPV.0060 Special 34. Reducer 8"x4" Special	2.000 EACH	_____.	_____.
0304	SPV.0060 Special 35. Reducer 8"x6" Special	3.000 EACH	_____.	_____.
0306	SPV.0060 Special 36. Reducer 10"x8" Special	2.000 EACH	_____.	_____.
0308	SPV.0060 Special 37. Connect to Existing Watermain	9.000 EACH	_____.	_____.
0310	SPV.0060 Special 38. Corporation, Curb Stop & Box (Set)	58.000 EACH	_____.	_____.



Proposal Schedule of Items

Proposal ID: 20211214021 Project(s): 6995-00-13, 6995-00-14

Federal ID(s): WISC 2022081, N/A

SECTION: 0001 Roadway Items

Alt Set ID: Alt Mbr ID:

Proposal Line Number	Item ID Description	Approximate Quantity and Units	Unit Price	Bid Amount
0312	SPV.0060 Special 39. Water Service Reconnection	58.000 EACH	_____.	_____.
0314	SPV.0060 Special 40. Utility Line Opening (ULO)	15.000 EACH	_____.	_____.
0316	SPV.0060 Special 41. Inlet Cover Type Driveway Special	3.000 EACH	_____.	_____.
0318	SPV.0060 Special 42. Temporary Water Service Project 6995-00-14	1.000 EACH	_____.	_____.
0320	SPV.0060 Special 43. Abandon/Remove Sanitary Sewer Project 6995-00-14	1.000 EACH	_____.	_____.
0322	SPV.0060 Special 44. Abandon/Remove Water Main Project 6995-00-14	1.000 EACH	_____.	_____.
0324	SPV.0090 Special 01. Sanitary Sewer Pipe 8-Inch Special	50.000 LF	_____.	_____.
0326	SPV.0090 Special 02. Sanitary Sewer Pipe 10-Inch Special	70.000 LF	_____.	_____.
0328	SPV.0090 Special 03. Sanitary Sewer Pipe 24-Inch Special	1,570.000 LF	_____.	_____.
0330	SPV.0090 Special 04. Sanitary Sewer Pipe 30-Inch Special	660.000 LF	_____.	_____.
0332	SPV.0090 Special 05. Sanitary Lateral 6-Inch	1,470.000 LF	_____.	_____.
0334	SPV.0090 Special 06. Sanitary Sewer Televising	2,335.000 LF	_____.	_____.
0336	SPV.0090 Special 07. PVC Water Main 4-Inch Special	20.000 LF	_____.	_____.
0338	SPV.0090 Special 08. PVC Water Main 6-Inch Special	80.000 LF	_____.	_____.



Proposal Schedule of Items

Proposal ID: 20211214021 Project(s): 6995-00-13, 6995-00-14

Federal ID(s): WISC 2022081, N/A

SECTION: 0001 Roadway Items

Alt Set ID: Alt Mbr ID:

Proposal Line Number	Item ID Description	Approximate Quantity and Units	Unit Price	Bid Amount
0340	SPV.0090 Special 09. PVC Water Main 8-Inch Special	2,370.000 LF	_____.	_____.
0342	SPV.0090 Special 10. PVC Water Main 10-Inch Special	140.000 LF	_____.	_____.
0344	SPV.0090 Special 11. Water Service 1 to 2-Inch Special	1,540.000 LF	_____.	_____.
Section: 0001			Total:	_____.
			Total Bid:	_____.





**PLEASE ATTACH ADDENDA HERE**



# Wisconsin Department of Transportation

## Division of Transportation Systems Development

Bureau of Project Development  
4822 Madison Yards Way, 4<sup>th</sup> Floor South  
Madison, WI 53705

December 13, 2021

Telephone: (608) 266-1631  
Facsimile (FAX): (608) 266-8459

### NOTICE TO ALL CONTRACTORS:

<p><b>Proposal #21: 6995-0013, WISC 2022 081</b>  <b>C Beaver Dam, East Davis Street</b>  <b>S Spring Street – S University Ave</b>  <b>Local Street</b>  <b>Dodge County</b></p>	<p><b>6995-00-14</b>  <b>C Bever Dam, East Davis Street</b>  <b>S Spring Street – S University Ave</b>  <b>Local Street</b>  <b>Dodge County</b></p>
---	--

### Letting of December 14, 2021

This is Addendum No. 01, which provides for the following:

#### Schedule of Items:

Revised Bid Item Quantities					
Bid Item	Item Description	Unit	Old Quantity	Revised Quantity	Proposal Total
601.0409	Concrete Curb and Gutter 30-Inch Type A	LF	525	4,020	4,545
650.5500	Construction Staking Curb Gutter and Curb & Gutter	LF	885	-525	360

Deleted Bid Item Quantities					
Bid Item	Item Description	Unit	Old Quantity	Revised Quantity	Proposal Total
601.0452	Concrete Curb and Gutter Integral 30-Inch Type D	LF	4,020	-4,020	0

#### Plan Sheets:

Revised Plan Sheets	
Plan Sheet	Plan Sheet Title (brief description of changes to sheet)
4	Updated Typical Section to change from integral curb and gutter to traditional
12-15	Updated Paving Grades to change from integral curb and gutter to traditional
54	Updated MQs to reflect change from integral curb and gutter to traditional

**Schedule of Items**

Attached, dated December 13, 2021, are the revised Schedule of Items Pages 1 – 12.

**Plan Sheets**

The following 8½ x 11-inch sheets are attached and made part of the plans for this proposal:

Revised: 4, 12-15 and 54.

The responsibility for notifying potential subcontractors and suppliers of these changes remains with the prime contractor.

Sincerely,

*Mike Coleman*

Proposal Development Specialist  
Proposal Management Section

END OF ADDENDUM

Addendum No. 01  
 ID 6995-00-13  
 Revised Sheet 4  
 December 13, 2021

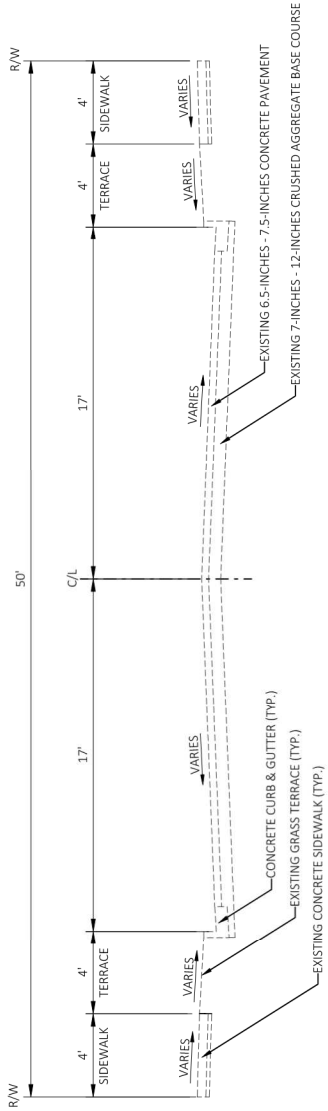

**EXISTING TYPICAL SECTION - EAST DAVIS STREET**

S. SPRING STREET - S. UNIVERSITY AVENUE  
 (STA. 22+73.13 - STA. 44+84.34)

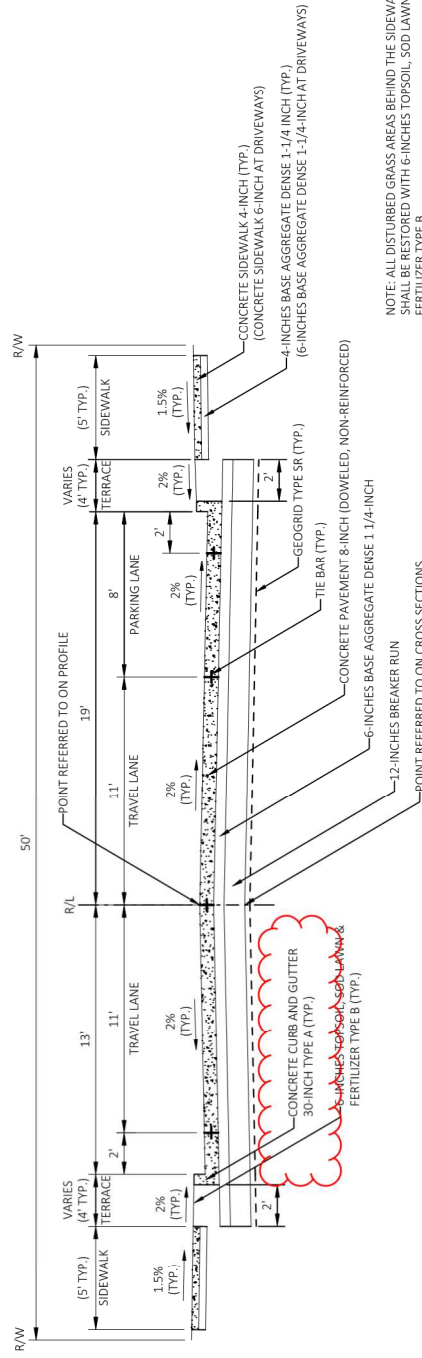

**PROPOSED TYPICAL SECTION - EAST DAVIS STREET**

S. SPRING STREET - S. UNIVERSITY AVENUE  
 (STA. 22+73.13 - STA. 44+84.34)

<b>PROJECT NO:</b> 6995-00-13	<b>COUNTY:</b> DODGE	<b>TYPICAL SECTIONS</b>	<b>SHEET</b> 4
<small>FILE NAME: \\MSKAFS.COM\PROJECTS\000218\00218\045\CADD - GENERAL\CADD - E. DAVIS STREET - STP URBAN\00218\045\001-TS.DWG</small>	<small>LOT DATE: 12/10/2021 8:41 AM</small>	<small>LOT NAME: JASON DOLENS</small>	<small>LOT SCALE: 1:6</small>
<small>PROJECT NO: 6995-00-13</small>	<small>HWY: E. DAVIS STREET</small>	<small>FILE NAME: JASON DOLENS</small>	<small>LOT SCALE: 1:6</small>
<small>FILE NAME: \\MSKAFS.COM\PROJECTS\000218\00218\045\CADD - GENERAL\CADD - E. DAVIS STREET - STP URBAN\00218\045\001-TS.DWG</small>	<small>LOT DATE: 12/10/2021 8:41 AM</small>	<small>LOT NAME: JASON DOLENS</small>	<small>LOT SCALE: 1:6</small>

Addendum No. 01  
 ID 6995-00-13  
 Revised Sheet 12  
 December 13, 2021

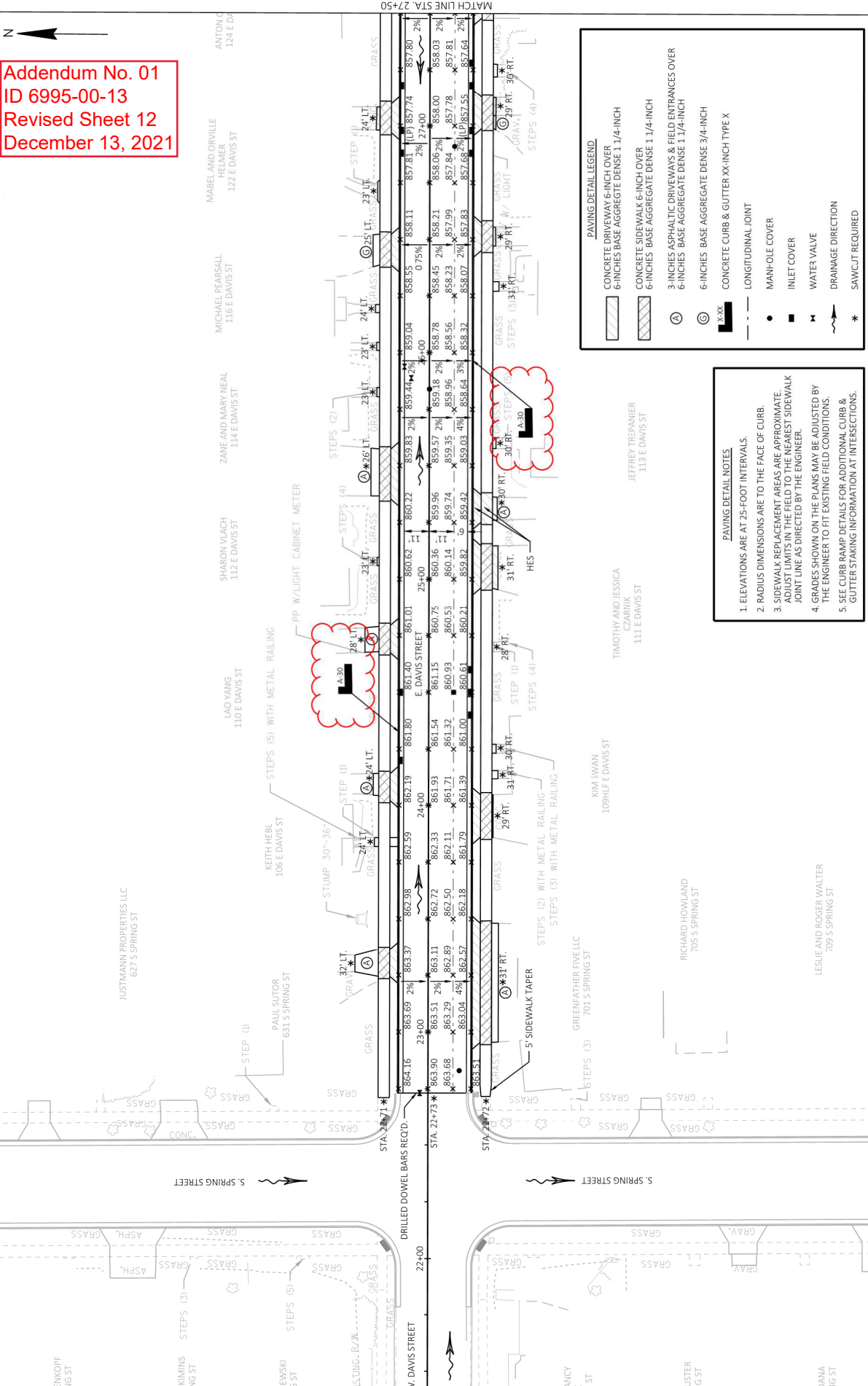

**PAVING DETAIL LEGEND**

- CONCRETE DRIVEWAY 6-INCH OVER 6-INCHES BASE AGGREGATE DENSE 1 1/4-INCH
- CONCRETE SIDEWALK 6-INCH OVER 6-INCHES BASE AGGREGATE DENSE 1 1/4-INCH
- 3-INCHES ASPHALT DRIVEWAYS & FIELD ENTRANCES OVER 6-INCHES BASE AGGREGATE DENSE 1 1/4-INCH
- 6-INCHES BASE AGGREGATE DENSE 3/4-INCH
- CONCRETE CURB & GUTTER XX-INCH TYPE X
- LONGITUDINAL JOINT
- MANHOLE COVER
- INLET COVER
- WATER VALVE
- DRAINAGE DIRECTION
- SAWCUT REQUIRED

**PAVING DETAIL NOTES**

- ELEVATIONS ARE AT 25-FOOT INTERVALS.
- RADIUS DIMENSIONS ARE TO THE FACE OF CURB.
- SIDEWALK REPLACEMENT AREAS ARE APPROXIMATE. ADJUST LIMITS IN THE FIELD TO THE NEAREST SIDEWALK JOINT LINE AS DIRECTED BY THE ENGINEER.
- GRADES SHOWN ON THE PLANS MAY BE ADJUSTED BY THE ENGINEER TO FIT EXISTING FIELD CONDITIONS.
- SEE CURB RAMP DETAILS FOR ADDITIONAL CURB & GUTTER STAKING INFORMATION AT INTERSECTIONS.

**PAVING DETAIL LEGEND**

- CONCRETE DRIVEWAY 6-INCH OVER 6-INCHES BASE AGGREGATE DENSE 1 1/4-INCH
- CONCRETE SIDEWALK 6-INCH OVER 6-INCHES BASE AGGREGATE DENSE 1 1/4-INCH
- 3-INCHES ASPHALTIC DRIVEWAYS & FIELD ENTRANCES OVER 6-INCHES BASE AGGREGATE DENSE 1 1/4-INCH
- 6-INCHES BASE AGGREGATE DENSE 3/4-INCH CONCRETE CURB & GUTTER XX-INCH TYPE X

**LONGITUDINAL JOINT**

- MANHOLE COVER
- INLET COVER
- WATER VALVE
- DRAINAGE DIRECTION
- SAWCUT REQUIRED

- PAVING DETAIL NOTES:**
- ELEVATIONS ARE AT 25-FOOT INTERVALS.
  - RADIUS DIMENSIONS ARE TO THE FACE OF CURB.
  - SIDEWALK REPLACEMENT AREAS ARE APPROXIMATE. ADJUST LIMITS IN THE FIELD TO THE NEAREST SIDEWALK JOINT LINE AS DIRECTED BY THE ENGINEER.
  - GRADES SHOWN ON THE PLANS MAY BE ADJUSTED BY THE ENGINEER TO FIT EXISTING FIELD CONDITIONS.
  - SEE CURB RAMP DETAILS FOR ADDITIONAL CURB & GUTTER STAKING INFORMATION AT INTERSECTIONS.

**CURB & GUTTER RADIUS POINT TABLE**

POINT NUMBER	RADIUS	STATION	OFFSET	NORTHING	EASTING
2A	16.0'	29+04.10	29.00' LT	720494.73	848264.35
2B	15.5'	29+63.90	28.50' LT	720494.08	848325.51
2C	25.0'	28+84.34	44.00' RT	72021.60	848445.10
2D	25.0'	29+73.44	44.00' RT	72021.20	848331.20
2E	15.0'	32+48.83	34.00' RT	720401.87	848603.97
2F	16.0'	33+10.28	35.00' RT	720394.17	848664.94

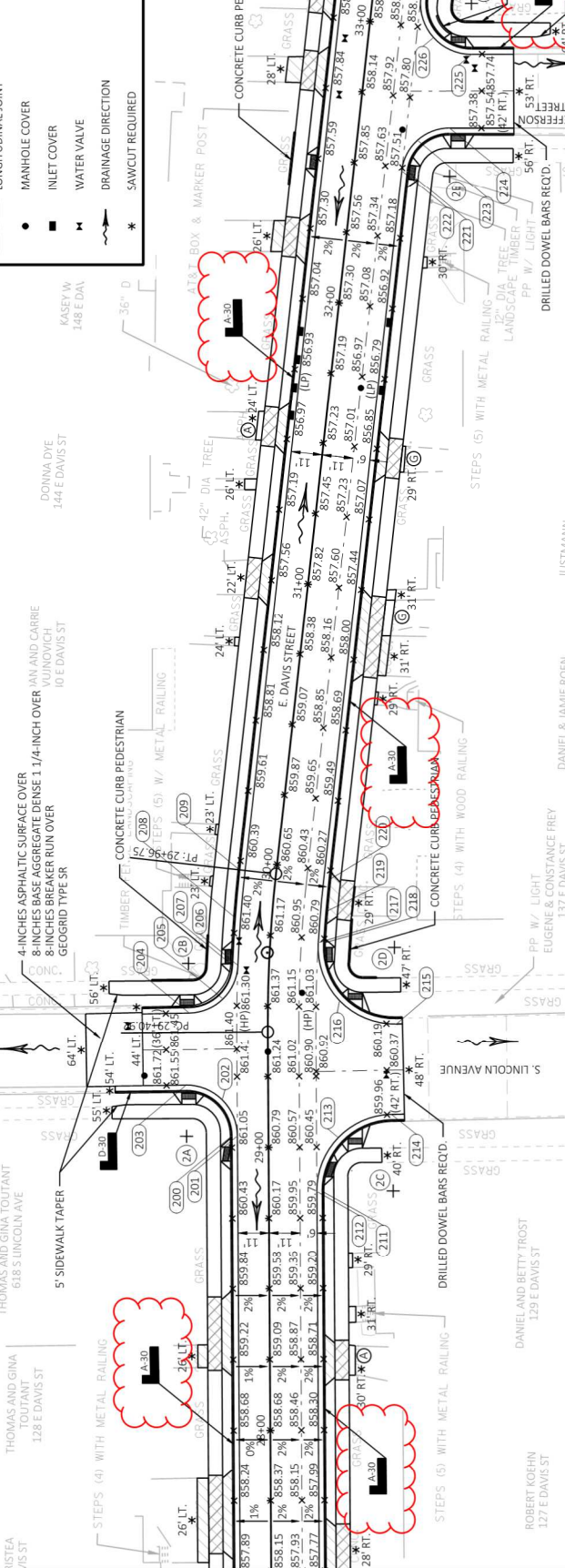

**CURB & GUTTER POINT TABLE**

POINT NUMBER	DESCRIPTION	STATION	OFFSET	ELEVATION	NORTHING	EASTING
210	PC	33+46.12	13.00' LT	858.63	720437.98	848705.80
211	END INTEGRAL	28+84.34	19.00' RT	860.02	720446.59	848244.92
212	PC/BEGIN GUTTER	28+84.34	17.00' RT	860.06	720448.59	848244.91
213	MID PT.	29+03.28	24.76' RT	860.38	720440.97	848263.91
214	PT	29+11.33	43.57' RT	859.93	720422.21	848272.09
215	PC	29+43.70	45.51' RT	860.10	720420.40	848304.21
216	MID PT.	29+52.42	25.32' RT	860.67	720440.62	848312.44
217	PT/END GUTTER	29+73.44	17.00' RT	860.85	720448.16	848332.84
218	PC/BEGIN INTEGRAL	29+73.44	19.00' RT	860.81	720446.16	848332.72
219	MID PT.	29+85.09	19.00' RT	860.61	720445.34	848343.89

**CURB & GUTTER POINT TABLE**

POINT NUMBER	DESCRIPTION	STATION	OFFSET	ELEVATION	NORTHING	EASTING
220	PT	29+96.75	19.00' RT	860.36	720444.26	848355.03
221	END INTEGRAL	32+48.83	19.00' RT	857.46	720416.78	848655.60
222	PC/BEGIN GUTTER	32+48.83	17.00' RT	857.50	720418.76	848655.82
223	MID PT.	32+60.18	21.34' RT	857.53	720413.21	848616.63
224	PT	32+65.73	32.15' RT	857.45	720401.87	848620.97
225	PC	32+92.40	37.04' RT	857.57	720394.10	848652.90
226	MID PT.	32+96.85	23.01' RT	857.90	720407.55	848652.90
227	PT/END GUTTER	33+10.28	17.00' RT	858.21	720412.07	848656.91
228	BEGIN INTEGRAL	33+10.28	19.00' RT	858.17	720410.08	848656.69
229	PC	33+46.12	19.00' RT	858.64	720406.17	848732.31

**CURB & GUTTER POINT TABLE**

POINT NUMBER	DESCRIPTION	STATION	OFFSET	ELEVATION	NORTHING	EASTING
200	END INTEGRAL	29+04.10	13.00' LT	861.14	720478.73	848264.46
201	PC/BEGIN GUTTER	29+04.10	11.00' LT	861.10	720476.73	848264.47
202	MID PT.	29+16.85	16.30' LT	861.32	720482.13	848277.19
203	PT	29+22.10	29.08' LT	861.47	720494.94	848282.34
204	PC	29+47.38	27.74' LT	861.37	720493.74	848308.01
205	MID PT.	29+52.29	15.90' LT	861.25	720481.84	848313.01
206	PT/END GUTTER	29+63.90	11.00' LT	861.18	720476.60	848324.79
207	PC	29+63.90	13.00' LT	861.16	720478.60	848324.88
208	MID PT.	29+80.33	13.00' LT	860.83	720477.62	848341.72
209	PT	29+96.75	13.00' LT	860.48	720476.07	848358.52



**Addendum No. 01**  
**ID 6995-00-13**  
**Revised Sheet 14**  
**December 13, 2021**

2

2

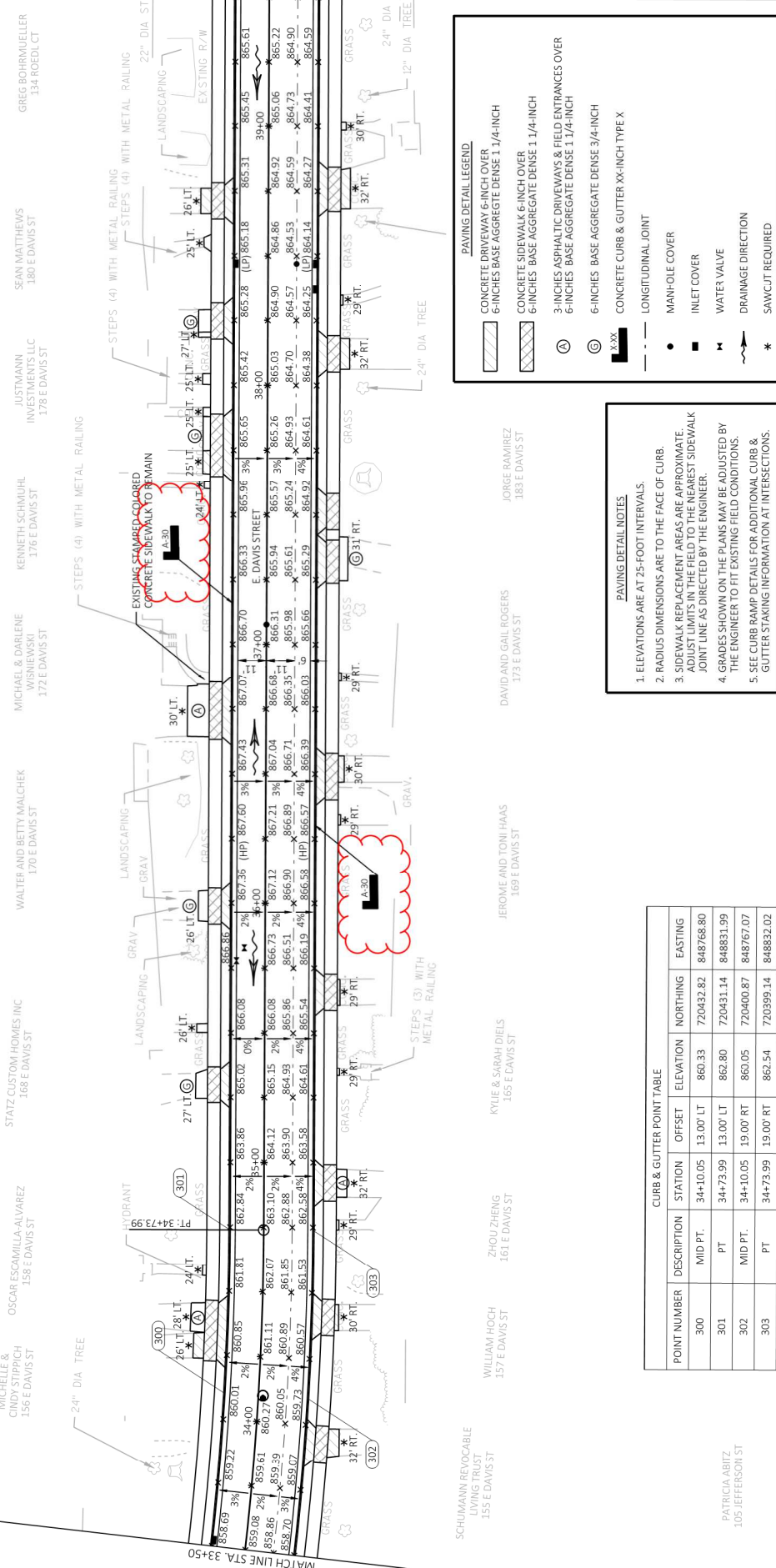

**PAVING DETAIL LEGEND**

- CONCRETE DRIVEWAY 6-INCH OVER 6-INCHES BASE AGGREGATE DENSE 1 1/4-INCH
- CONCRETE SIDEWALK 6-INCH OVER 6-INCHES BASE AGGREGATE DENSE 1 1/4-INCH
- 3-INCHES ASPHALTIC DRIVEWAYS & FIELD ENTRANCES OVER 6-INCHES BASE AGGREGATE DENSE 1 1/4-INCH
- 6-INCHES BASE AGGREGATE DENSE 3/4-INCH
- CONCRETE CURB & GUTTER XX-INCH TYPE X
- LONGITUDINAL JOINT
- MANHOLE COVER
- INLET COVER
- WATER VALVE
- DRAINAGE DIRECTION
- SAWCUT REQUIRED

**PAVING DETAIL NOTES**

1. ELEVATIONS ARE AT 25-FOOT INTERVALS.
2. RADIUS DIMENSIONS ARE TO THE FACE OF CURB.
3. SIDEWALK REPLACEMENT AREAS ARE APPROXIMATE. ADJUST LIMITS IN THE FIELD TO THE NEAREST SIDEWALK JOINT LINE AS DIRECTED BY THE ENGINEER.
4. GRADES SHOWN ON THE PLANS MAY BE ADJUSTED BY THE ENGINEER TO FIT EXISTING FIELD CONDITIONS.
5. SEE CURB RAMP DETAILS FOR ADDITIONAL CURB & GUTTER STAKING INFORMATION AT INTERSECTIONS.

**CURB & GUTTER POINT TABLE**

POINT NUMBER	DESCRIPTION	STATION	OFFSET	ELEVATION	NORTHING	EASTING
300	MID PT.	34+10.05	13.00' LT	860.33	720432.82	848768.80
301	PT	34+73.99	13.00' LT	862.80	720431.14	848831.99
302	MID PT.	34+10.05	19.00' RT	860.05	720400.87	848767.07
303	PT	34+73.99	19.00' RT	862.54	720399.14	848832.02



Addendum No. 01  
 ID 6995-00-13  
 Revised Sheet 15  
 December 13, 2021

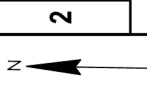

- PAVING DETAIL NOTES**
- ELEVATIONS ARE AT 25-FOOT INTERVALS.
  - RADIUS DIMENSIONS ARE TO THE FACE OF CURB.
  - SIDEWALK REPLACEMENT AREAS ARE APPROXIMATE. ADJUST LIMITS IN THE FIELD TO THE NEAREST SIDEWALK JOINT LINE AS DIRECTED BY THE ENGINEER.
  - GRADES SHOWN ON THE PLANS MAY BE ADJUSTED BY THE ENGINEER TO FIT EXISTING FIELD CONDITIONS.
  - SEE CURB BUMP DETAILS FOR ADDITIONAL CURB & GUTTER STAKING INFORMATION AT INTERSECTIONS.

- PAVING DETAIL LEGEND**
- CONCRETE DRIVEWAY 6-INCH OVER
  - 6-INCHES BASE AGGREGATE DENSE 1 1/4-INCH
  - CONCRETE SIDEWALK 6-INCH OVER
  - 6-INCHES BASE AGGREGATE DENSE 1 1/4-INCH
  - 3-INCHES ASPHALTIC DRIVEWAYS & FIELD ENTRANCES OVER
  - 6-INCHES BASE AGGREGATE DENSE 1 1/4-INCH
  - 6-INCHES BASE AGGREGATE DENSE 3/4-INCH
  - CONCRETE CURB & GUTTER XX-INCH TYPE X
  - LONGITUDINAL JOINT
  - MANHOLE COVER
  - INLET COVER
  - WATER VALVE
  - DRAINAGE DIRECTION
  - SAWCUT REQUIRED

**CURB & GUTTER RADIUS POINT TABLE**

POINT NUMBER	RADIUS	STATION	OFFSET	NORTHING	EASTING
4A	16.0'	39+73.89	29.00' LT	7204747.95	8493311.15
4B	16.0'	40+35.84	29.00' LT	7204495.55	8493933.08
4C	16.0'	39+71.66	35.00' RT	7203833.92	8493330.57
4D	16.0'	40+36.66	35.00' RT	7203985.59	8493955.54
4E	16.0'	44+44.49	29.00' LT	7204533.95	8498021.16
4F	16.0'	44+55.18	35.00' RT	7203900.06	8498133.50

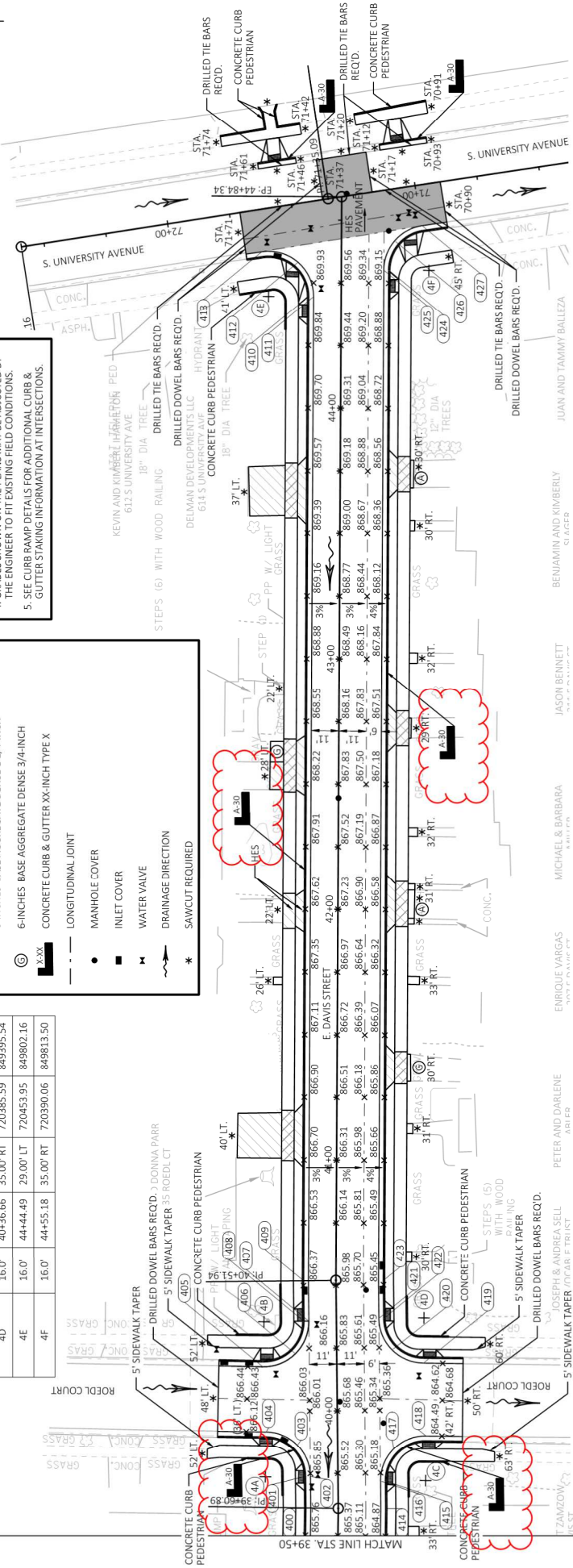

**CURB & GUTTER POINT TABLE**

POINT NUMBER	DESCRIPTION	STATION	OFFSET	ELEVATION	NORTHING	EASTING
420	MID PT.	40+24.07	22.13' RT	865.30	7203988.13	8493822.63
421	PT/END GUTTER	40+36.66	17.00' RT	865.56	7204033.58	8493955.08
422	BEGIN INTEGRAL	40+36.66	19.00' RT	865.52	7204011.58	8493955.13
423	BEND PT.	40+52.08	19.00' RT	865.44	7204011.97	8494102.26
424	END INTEGRAL	44+55.18	19.00' RT	869.21	7204060.06	8498133.31
425	PC/BEGIN GUTTER	44+55.18	17.00' RT	869.25	7204008.06	8498133.31
426	MID PT.	44+66.89	21.33' RT	869.01	7204033.85	8498255.06
427	PT	44+72.96	32.23' RT	868.52	7203993.01	8498331.25

**CURB & GUTTER POINT TABLE**

POINT NUMBER	DESCRIPTION	STATION	OFFSET	ELEVATION	NORTHING	EASTING
410	END INTEGRAL	44+44.49	13.00' LT	870.10	720437.95	8498023.32
411	PC/BEGIN GUTTER	44+44.49	11.00' LT	869.89	720435.95	8498023.34
412	MID PT.	44+58.16	17.29' LT	870.01	720442.37	849815.94
413	BEND PT.	44+62.28	31.76' LT	870.43	720456.88	849819.92
414	BEND PT.	39+60.89	19.00' RT	865.12	7203995.91	849330.16
415	END INTEGRAL	39+71.66	17.00' RT	865.16	720401.91	849330.11
416	PC/BEGIN GUTTER	39+71.66	17.00' RT	865.03	720396.83	849343.11
417	MID PT.	39+84.53	22.41' RT	864.65	720383.98	849348.57
418	BEND PT.	39+89.65	35.40' RT	864.86	720385.53	849377.54
419	BEND PT.	40+18.66	34.59' RT	864.86	720385.53	849377.54

**CURB & GUTTER POINT TABLE**

POINT NUMBER	DESCRIPTION	STATION	OFFSET	ELEVATION	NORTHING	EASTING
400	BEND PT.	39+61.05	13.00' LT	865.82	720431.63	849318.73
401	END INTEGRAL	39+73.89	13.00' LT	865.91	720431.96	849331.56
402	PC/BEGIN GUTTER	39+73.89	11.00' LT	865.85	720429.96	849331.61
403	MID PT.	39+86.45	16.11' LT	865.93	720435.39	849344.04
404	PT	39+91.88	28.54' LT	866.01	720447.95	849344.04
405	PC	40+17.85	29.55' LT	866.38	720449.63	849375.08
406	MID PT.	40+23.92	16.47' LT	866.28	720436.68	849380.49
407	PT/END GUTTER	40+35.84	11.00' LT	866.23	720431.55	849393.55
408	BEGIN INTEGRAL	40+35.84	13.00' LT	866.29	720433.55	849393.49
409	BEND PT.	40+51.94	13.00' LT	866.38	720433.97	849409.69

**PROJECT NO:** 6995-00-13  
**HWY:** E. DAVIS STREET  
**COUNTY:** DODGE  
**PAVING DETAILS**

FILE NAME: \\MSKAFS\COMP\PROJECT\000218\00218\BMS\CADD - GENERAL\CADD - STP URBAN\SHETS\PLAN\021201-PO.DWG  
 LAYOUT NAME: 021205.plt  
 PLOT DATE: 12/10/2021 9:53 AM  
 PLOT BY: JASON DOLENS  
 PLOT SCALE: 1 IN=40 FT  
**SHEET 15**  
 WISDOT/CADD/SHEET 42

Addendum No. 01  
 ID 6995-00-13  
 Revised Sheet 54  
 December 13, 2021

3

CONCRETE PAVEMENT									
CATEGORY	STATION	TO STATION	LOCATION	(605.0120)	(624.0100)	(311.0110)	(415.0080)	(415.1080)	(645.0220)
				BASE AGGREGATE DENSE 1 1/4-INCH	WATER	BREAKER RUN	CONCRETE PAVEMENT 8-INCH	CONCRETE PAVEMENT CONCRETE HE 8-INCH	GEORGRID TYPE SR
0010	22+73	44+67	LT & RT	3,240	45	5670	7,465	-	9,722
	44+67	44+84	LT & RT	62	1	108	-	185	185
	70+93	71+12	RT	3	-	-	-	-	-
	71+46	71+61	RT	3	-	-	-	-	-
<b>PROJECT TOTALS</b>				<b>3,308</b>	<b>46</b>	<b>5,778</b>	<b>7,465</b>	<b>185</b>	<b>9,907</b>

\*ADDITIONAL QUANTITIES FOUND ELSEWHERE

NOTE: WATER BID ITEM TO BE USED FOR BASE AGGREGATE DUST CONTROL AND COMPACTION.

DRILLED TIE AND DOWEL BARS

CATEGORY	STATION	TO STATION	LOCATION	(416.0610)	(416.0620)
				DRILLED TIE BARS EACH	DRILLED DOWEL BARS EACH
0010	22+73	29+47	LT & RT	-	26
	29+09	32+94	RT	-	21
	32+68	40+18	RT	-	23
	39+89	40+18	LT	-	21
	39+92	40+18	LT	-	13
	71+71	71+37	ONLINE	13	-
	71+37	71+17	RT	-	12
	71+37	71+17	RT	8	-
	71+17	70+90	ONLINE	11	-
	70+90	71+12	LT	-	13
	70+93	71+61	RT	8	-
	71+46	71+61	RT	6	-
<b>PROJECT TOTALS</b>				<b>46</b>	<b>167</b>

CONCRETE CURB & GUTTER

CATEGORY	STATION	TO STATION	LOCATION	(601.0409)	(601.0411)	(601.0415)	(602.0405)	(602.0415)	(602.0415)	(602.0505)	(650.5500)
				CONCRETE CURB & GUTTER 30-INCH TYPE A	CONCRETE CURB & GUTTER 30-INCH TYPE D	CONCRETE CURB & GUTTER 30-INCH TYPE D	CONCRETE SIDEWALK 4-INCH	CONCRETE SIDEWALK 6-INCH	CONCRETE SIDEWALK DETECTABLE WARNING FIELD YELLOW	CONCRETE RAMP CONSTRUCTION STAKING CURB RAMP'S	
0010	22+73	29+20	LT	672	10	10	2,730	755	20	20	2
	22+73	29+10	RT	656	-	-	2,450	795	20	20	2
	29+46	32+66	RT	384	-	-	1,565	285	40	40	4
	29+49	39+90	LT	1,094	-	-	4,635	1,050	50	50	5
	32+94	39+88	RT	746	-	-	3,205	680	30	30	3
	40+20	44+61	LT	486	-	-	2,130	320	40	40	4
	40+20	44+73	RT	492	-	-	2,310	310	40	40	4
	70+93	71+12	RT	19	-	-	210	10	10	10	1
	71+46	71+61	RT	16	-	-	245	10	10	10	1
<b>PROJECT TOTALS</b>				<b>4,545</b>	<b>10</b>	<b>10</b>	<b>19,480</b>	<b>4,195</b>	<b>260</b>	<b>260</b>	<b>26</b>

\*ADDITIONAL QUANTITIES FOUND ELSEWHERE

CONCRETE CURB PEDESTRIAN

CATEGORY	STATION	TO STATION	LOCATION	(601.0600)	(650.5500)
				CONCRETE CURB PEDESTRIAN	CONSTRUCTION STAKING CURB & GUTTER
0010	29+58	29+74	LT	34	34
	29+61	29+83	RT	29	29
	32+39	32+58	LT	19	19
	32+99	33+05	RT	8	8
	33+04	33+18	RT	28	28
	39+65	39+79	RT	28	28
	39+66	39+82	LT	27	27
	40+29	40+46	RT	31	31
	40+31	40+51	LT	37	37
	44+31	44+45	LT	33	33
	70+91	71+20	RT	29	29
	71+42	71+50	RT	19	19
	71+56	71+74	RT	28	28
<b>PROJECT TOTALS</b>				<b>350</b>	<b>350</b>

\*ADDITIONAL QUANTITIES FOUND ELSEWHERE

CONCRETE SIDEWALK

CATEGORY	STATION	TO STATION	LOCATION	(305.0120)	(602.0405)	(602.0415)	(602.0415)	(602.0505)	(650.9000)
				BASE AGGREGATE DENSE 1 1/4-INCH	CONCRETE SIDEWALK 4-INCH	CONCRETE SIDEWALK 6-INCH	CONCRETE RAMP DETECTABLE WARNING FIELD YELLOW	CONSTRUCTION STAKING CURB RAMP'S	
0010	22+71	29+20	LT	95	2,730	755	20	20	2
	22+72	29+08	RT	92	2,450	795	20	20	2
	29+48	32+64	RT	49	1,565	285	40	40	4
	29+50	39+91	LT	153	4,635	1,050	50	50	5
	32+95	39+87	RT	104	3,205	680	30	30	3
	40+20	44+59	LT	67	2,130	320	40	40	4
	40+21	44+71	RT	69	2,310	310	40	40	4
	70+91	71+20	RT	5	210	10	10	10	1
	71+42	71+74	RT	6	245	10	10	10	1
<b>PROJECT TOTALS</b>				<b>641</b>	<b>19,480</b>	<b>4,195</b>	<b>260</b>	<b>260</b>	<b>26</b>

\*ADDITIONAL QUANTITIES FOUND ELSEWHERE

PROJECT NO: 6995-00-13

HWY: E. DAVIS STREET

COUNTY: DODGE

MISCELLANEOUS QUANTITIES

SHEET 54

E

3



Proposal Schedule of Items

Proposal ID: 20211214021 Project(s): 6995-00-13, 6995-00-14

Federal ID(s): WISC 2022081, N/A

SECTION: 0001 Roadway Items

Alt Set ID: Alt Mbr ID:

Proposal Line Number	Item ID Description	Approximate Quantity and Units	Unit Price	Bid Amount
0002	201.0120 Clearing	114.000 ID	_____.	_____.
0004	201.0220 Grubbing	114.000 ID	_____.	_____.
0006	204.0100 Removing Concrete Pavement	9,613.000 SY	_____.	_____.
0008	204.0150 Removing Curb & Gutter	85.000 LF	_____.	_____.
0010	204.0155 Removing Concrete Sidewalk	2,115.000 SY	_____.	_____.
0012	204.0210 Removing Manholes	5.000 EACH	_____.	_____.
0014	204.0220 Removing Inlets	14.000 EACH	_____.	_____.
0016	204.0245 Removing Storm Sewer (size) 01. 12-Inch or Less	295.000 LF	_____.	_____.
0018	204.0245 Removing Storm Sewer (size) 02. 15-Inch	231.000 LF	_____.	_____.
0020	204.0245 Removing Storm Sewer (size) 03. 18-Inch	10.000 LF	_____.	_____.
0022	204.0245 Removing Storm Sewer (size) 04. 21-Inch	414.000 LF	_____.	_____.
0024	204.0245 Removing Storm Sewer (size) 05. 24-Inch	207.000 LF	_____.	_____.
0026	204.0245 Removing Storm Sewer (size) 06. 36-Inch	95.000 LF	_____.	_____.
0028	204.0280 Sealing Pipes	2.000 EACH	_____.	_____.
0030	205.0100 Excavation Common	7,720.000 CY	_____.	_____.



## Proposal Schedule of Items

Proposal ID: 20211214021 Project(s): 6995-00-13, 6995-00-14

Federal ID(s): WISC 2022081, N/A

SECTION: 0001

Roadway Items

Alt Set ID:

Alt Mbr ID:

Proposal Line Number	Item ID Description	Approximate Quantity and Units	Unit Price	Bid Amount
0032	213.0100 Finishing Roadway (project) 01. 6995-00-13	1.000 EACH	_____.	_____.
0034	305.0110 Base Aggregate Dense 3/4-Inch	16.000 TON	_____.	_____.
0036	305.0120 Base Aggregate Dense 1 1/4-Inch	4,180.000 TON	_____.	_____.
0038	310.0115 Base Aggregate Open-Graded	10.000 CY	_____.	_____.
0040	311.0110 Breaker Run	5,800.000 TON	_____.	_____.
0042	415.0080 Concrete Pavement 8-Inch	7,465.000 SY	_____.	_____.
0044	415.1080 Concrete Pavement HES 8-Inch	185.000 SY	_____.	_____.
0046	416.0160 Concrete Driveway 6-Inch	512.000 SY	_____.	_____.
0048	416.0260 Concrete Driveway HES 6-Inch	27.000 SY	_____.	_____.
0050	416.0610 Drilled Tie Bars	46.000 EACH	_____.	_____.
0052	416.0620 Drilled Dowel Bars	167.000 EACH	_____.	_____.
0054	455.0605 Tack Coat	3.000 GAL	_____.	_____.
0056	465.0105 Asphaltic Surface	13.000 TON	_____.	_____.
0058	465.0120 Asphaltic Surface Driveways and Field Entrances	16.000 TON	_____.	_____.
0060	520.8000 Concrete Collars for Pipe	6.000 EACH	_____.	_____.
0062	601.0409 Concrete Curb & Gutter 30-Inch Type A	4,545.000 LF	_____.	_____.



Proposal Schedule of Items

Proposal ID: 20211214021 Project(s): 6995-00-13, 6995-00-14

Federal ID(s): WISC 2022081, N/A

SECTION: 0001 Roadway Items

Alt Set ID: Alt Mbr ID:

Proposal Line Number	Item ID Description	Approximate Quantity and Units	Unit Price	Bid Amount
0064	601.0411 Concrete Curb & Gutter 30-Inch Type D	10.000 LF	_____.	_____.
0068	601.0600 Concrete Curb Pedestrian	350.000 LF	_____.	_____.
0070	602.0405 Concrete Sidewalk 4-Inch	19,480.000 SF	_____.	_____.
0072	602.0415 Concrete Sidewalk 6-Inch	4,195.000 SF	_____.	_____.
0074	602.0505 Curb Ramp Detectable Warning Field Yellow	260.000 SF	_____.	_____.
0076	608.0412 Storm Sewer Pipe Reinforced Concrete Class IV 12-Inch	163.000 LF	_____.	_____.
0078	608.0415 Storm Sewer Pipe Reinforced Concrete Class IV 15-Inch	20.000 LF	_____.	_____.
0080	608.0418 Storm Sewer Pipe Reinforced Concrete Class IV 18-Inch	57.000 LF	_____.	_____.
0082	608.0424 Storm Sewer Pipe Reinforced Concrete Class IV 24-Inch	233.000 LF	_____.	_____.
0084	608.0430 Storm Sewer Pipe Reinforced Concrete Class IV 30-Inch	261.000 LF	_____.	_____.
0086	608.3012 Storm Sewer Pipe Class III-A 12-Inch	155.000 LF	_____.	_____.
0088	608.3015 Storm Sewer Pipe Class III-A 15-Inch	8.000 LF	_____.	_____.
0090	608.3018 Storm Sewer Pipe Class III-A 18-Inch	292.000 LF	_____.	_____.
0092	608.3030 Storm Sewer Pipe Class III-A 30-Inch	167.000 LF	_____.	_____.
0094	608.3036 Storm Sewer Pipe Class III-A 36-Inch	94.000 LF	_____.	_____.



## Proposal Schedule of Items

Proposal ID: 20211214021 Project(s): 6995-00-13, 6995-00-14

Federal ID(s): WISC 2022081, N/A

SECTION: 0001

Roadway Items

Alt Set ID:

Alt Mbr ID:

Proposal Line Number	Item ID Description	Approximate Quantity and Units	Unit Price	Bid Amount
0096	608.6010 Storm Sewer Pipe Composite 10-Inch	13.000 LF	_____.	_____.
0098	611.0530 Manhole Covers Type J	10.000 EACH	_____.	_____.
0100	611.0624 Inlet Covers Type H	27.000 EACH	_____.	_____.
0102	611.2004 Manholes 4-FT Diameter	2.000 EACH	_____.	_____.
0104	611.2005 Manholes 5-FT Diameter	6.000 EACH	_____.	_____.
0106	611.2006 Manholes 6-FT Diameter	3.000 EACH	_____.	_____.
0108	611.3004 Inlets 4-FT Diameter	3.000 EACH	_____.	_____.
0110	611.3230 Inlets 2x3-FT	26.000 EACH	_____.	_____.
0112	611.8110 Adjusting Manhole Covers	2.000 EACH	_____.	_____.
0114	611.8115 Adjusting Inlet Covers	1.000 EACH	_____.	_____.
0116	612.0106 Pipe Underdrain 6-Inch	254.000 LF	_____.	_____.
0118	612.0902.S Insulation Board Polystyrene (inch) 01.2-Inch	162.560 SY	_____.	_____.
0120	618.0100 Maintenance And Repair of Haul Roads (project) 01. 6995-00-13	1.000 EACH	_____.	_____.
0122	619.1000 Mobilization	1.000 EACH	_____.	_____.
0124	624.0100 Water	46.000 MGAL	_____.	_____.
0126	625.0100 Topsoil	2,200.000 SY	_____.	_____.



Proposal Schedule of Items

Proposal ID: 20211214021 Project(s): 6995-00-13, 6995-00-14

Federal ID(s): WISC 2022081, N/A

SECTION: 0001 Roadway Items

Alt Set ID: Alt Mbr ID:

Proposal Line Number	Item ID Description	Approximate Quantity and Units	Unit Price	Bid Amount
0128	628.1905 Mobilizations Erosion Control	12.000 EACH	_____.	_____.
0130	628.1910 Mobilizations Emergency Erosion Control	6.000 EACH	_____.	_____.
0132	628.7005 Inlet Protection Type A	1.000 EACH	_____.	_____.
0134	628.7020 Inlet Protection Type D	58.000 EACH	_____.	_____.
0136	628.7560 Tracking Pads	4.000 EACH	_____.	_____.
0138	629.0210 Fertilizer Type B	1.400 CWT	_____.	_____.
0140	631.0300 Sod Water	125.000 MGAL	_____.	_____.
0142	631.1000 Sod Lawn	2,200.000 SY	_____.	_____.
0144	634.0812 Posts Tubular Steel 2x2-Inch X 12-FT	4.000 EACH	_____.	_____.
0146	634.0814 Posts Tubular Steel 2x2-Inch X 14-FT	26.000 EACH	_____.	_____.
0148	634.0816 Posts Tubular Steel 2x2-Inch X 16-FT	2.000 EACH	_____.	_____.
0150	637.2210 Signs Type II Reflective H	79.830 SF	_____.	_____.
0152	637.2220 Signs Type II Reflective SH	13.240 SF	_____.	_____.
0154	637.2230 Signs Type II Reflective F	37.750 SF	_____.	_____.
0156	638.2602 Removing Signs Type II	28.000 EACH	_____.	_____.
0158	638.3000 Removing Small Sign Supports	27.000 EACH	_____.	_____.
0160	642.5001 Field Office Type B	1.000 EACH	_____.	_____.



Proposal Schedule of Items

Proposal ID: 20211214021 Project(s): 6995-00-13, 6995-00-14

Federal ID(s): WISC 2022081, N/A

SECTION: 0001 Roadway Items

Alt Set ID: Alt Mbr ID:

Proposal Line Number	Item ID Description	Approximate Quantity and Units	Unit Price	Bid Amount
0162	643.0300 Traffic Control Drums	4,000.000 DAY	_____.	_____.
0164	643.0410 Traffic Control Barricades Type II	3,024.000 DAY	_____.	_____.
0166	643.0420 Traffic Control Barricades Type III	5,160.000 DAY	_____.	_____.
0168	643.0705 Traffic Control Warning Lights Type A	10,596.000 DAY	_____.	_____.
0170	643.0715 Traffic Control Warning Lights Type C	4,000.000 DAY	_____.	_____.
0172	643.0900 Traffic Control Signs	16,586.000 DAY	_____.	_____.
0174	643.1000 Traffic Control Signs Fixed Message	84.000 SF	_____.	_____.
0176	643.1050 Traffic Control Signs PCMS	7.000 DAY	_____.	_____.
0178	643.5000 Traffic Control	1.000 EACH	_____.	_____.
0180	644.1410 Temporary Pedestrian Surface Asphalt	800.000 SF	_____.	_____.
0182	644.1420 Temporary Pedestrian Surface Plywood	800.000 SF	_____.	_____.
0184	644.1430 Temporary Pedestrian Surface Plate	800.000 SF	_____.	_____.
0186	644.1601 Temporary Pedestrian Curb Ramp	5,000.000 DAY	_____.	_____.
0188	644.1810 Temporary Pedestrian Barricade	1,500.000 LF	_____.	_____.
0190	645.0111 Geotextile Type DF Schedule A	141.000 SY	_____.	_____.
0192	645.0220 Geogrid Type SR	9,965.000 SY	_____.	_____.
0194	646.1020 Marking Line Epoxy 4-Inch	550.000 LF	_____.	_____.





Proposal Schedule of Items

Proposal ID: 20211214021 Project(s): 6995-00-13, 6995-00-14

Federal ID(s): WISC 2022081, N/A

SECTION: 0001 Roadway Items

Alt Set ID: Alt Mbr ID:

Proposal Line Number	Item ID Description	Approximate Quantity and Units	Unit Price	Bid Amount
0196	646.6120 Marking Stop Line Epoxy 18-Inch	105.000 LF	_____.	_____.
0198	646.7420 Marking Crosswalk Epoxy Transverse Line 6-Inch	820.000 LF	_____.	_____.
0200	646.7520 Marking Crosswalk Epoxy Block Style 24-Inch	96.000 LF	_____.	_____.
0202	649.0150 Temporary Marking Line Removable Tape 4-Inch	500.000 LF	_____.	_____.
0204	650.4000 Construction Staking Storm Sewer	40.000 EACH	_____.	_____.
0206	650.4500 Construction Staking Subgrade	2,211.000 LF	_____.	_____.
0208	650.5500 Construction Staking Curb Gutter and Curb & Gutter	360.000 LF	_____.	_____.
0210	650.7000 Construction Staking Concrete Pavement	2,211.000 LF	_____.	_____.
0212	650.8500 Construction Staking Electrical Installations (project) 01. 6995-00-13	LS	LUMP SUM	_____.
0214	650.9000 Construction Staking Curb Ramps	26.000 EACH	_____.	_____.
0216	650.9910 Construction Staking Supplemental Control (project) 01. 6995-00-13	LS	LUMP SUM	_____.
0218	650.9920 Construction Staking Slope Stakes	2,211.000 LF	_____.	_____.
0220	652.0225 Conduit Rigid Nonmetallic Schedule 40 2-Inch	41.000 LF	_____.	_____.
0222	653.0135 Pull Boxes Steel 24x36-Inch	2.000 EACH	_____.	_____.
0224	690.0150 Sawing Asphalt	246.000 LF	_____.	_____.



Proposal Schedule of Items

Proposal ID: 20211214021 Project(s): 6995-00-13, 6995-00-14

Federal ID(s): WISC 2022081, N/A

SECTION: 0001 Roadway Items

Alt Set ID: Alt Mbr ID:

Proposal Line Number	Item ID Description	Approximate Quantity and Units	Unit Price	Bid Amount
0226	690.0250 Sawing Concrete	988.000 LF		
0228	715.0720 Incentive Compressive Strength Concrete Pavement	2,295.000 DOL	1.00000	2,295.00
0230	740.0440 Incentive IRI Ride	1,675.000 DOL	1.00000	1,675.00
0232	ASP.1T0A On-the-Job Training Apprentice at \$5.00/HR	2,000.000 HRS	5.00000	10,000.00
0234	ASP.1T0G On-the-Job Training Graduate at \$5.00/HR	1,200.000 HRS	5.00000	6,000.00
0236	SPV.0060 Special 01. Reconnect Storm Sewer Laterals	4.000 EACH		
0238	SPV.0060 Special 02. Concrete Pipe Support	2.000 EACH		
0240	SPV.0060 Special 03. Remove Ex. Sanitary Manhole	6.000 EACH		
0242	SPV.0060 Special 04. Remove Ex. Sanitary Vault Structure	1.000 EACH		
0244	SPV.0060 Special 05. Remove Ex. Water Valve Box	14.000 EACH		
0246	SPV.0060 Special 06. Remove Ex. Hydrant	6.000 EACH		
0248	SPV.0060 Special 07. Adjust Ex. Water Valve Box	4.000 EACH		
0250	SPV.0060 Special 08. Adjust Ex. Curb Stop Box	1.000 EACH		
0252	SPV.0060 Special 09. Sanitary Manhole (48 Inch)	3.000 EACH		
0254	SPV.0060 Special 10. Sanitary Manhole (60 Inch)	2.000 EACH		



Proposal Schedule of Items

Proposal ID: 20211214021 Project(s): 6995-00-13, 6995-00-14

Federal ID(s): WISC 2022081, N/A

SECTION: 0001 Roadway Items

Alt Set ID: Alt Mbr ID:

Proposal Line Number	Item ID Description	Approximate Quantity and Units	Unit Price	Bid Amount
0256	SPV.0060 Special 11. Sanitary Drop Manhole (48 Inch)	1.000 EACH	_____.	_____.
0258	SPV.0060 Special 12. Sanitary Drop Manhole (60 Inch)	1.000 EACH	_____.	_____.
0260	SPV.0060 Special 13. Sanitary MH Cover Type J-Special	7.000 EACH	_____.	_____.
0262	SPV.0060 Special 14. Connect to Existing Sanitary Sewer	6.000 EACH	_____.	_____.
0264	SPV.0060 Special 15. Sanitary WYE 30-Inch Main	17.000 EACH	_____.	_____.
0266	SPV.0060 Special 16. Sanitary WYE 24-Inch Main	41.000 EACH	_____.	_____.
0268	SPV.0060 Special 17. Sanitary Lateral Reconnection	58.000 EACH	_____.	_____.
0270	SPV.0060 Special 18. Water Valve & Box 6-Inch	6.000 EACH	_____.	_____.
0272	SPV.0060 Special 19. Water Valve & Box 8-Inch	12.000 EACH	_____.	_____.
0274	SPV.0060 Special 20. Water Valve & Box 10-Inch	2.000 EACH	_____.	_____.
0276	SPV.0060 Special 21. Fire Hydrant	6.000 EACH	_____.	_____.
0278	SPV.0060 Special 22. Cross 8"X8" Special	1.000 EACH	_____.	_____.
0280	SPV.0060 Special 23. Tees 8"x6"x8" Special	6.000 EACH	_____.	_____.
0282	SPV.0060 Special 24. Tees 8"x8"x8" Special	2.000 EACH	_____.	_____.
0284	SPV.0060 Special 25. Tees 10"x6"x10" Special	1.000 EACH	_____.	_____.



## Proposal Schedule of Items

Proposal ID: 20211214021 Project(s): 6995-00-13, 6995-00-14

Federal ID(s): WISC 2022081, N/A

SECTION: 0001

Roadway Items

Alt Set ID:

Alt Mbr ID:

Proposal Line Number	Item ID Description	Approximate Quantity and Units	Unit Price	Bid Amount
0286	SPV.0060 Special 26. Tees 10"x10"x10" Special	2.000 EACH	_____.	_____.
0288	SPV.0060 Special 27. Bend 11.25-Degree 8-Inch Special	3.000 EACH	_____.	_____.
0290	SPV.0060 Special 28. Bend 11.25-Degree 10-Inch Special	1.000 EACH	_____.	_____.
0292	SPV.0060 Special 29. Bend 45-Degree 4-Inch Special	4.000 EACH	_____.	_____.
0294	SPV.0060 Special 30. Bend 45-Degree 6-Inch Special	6.000 EACH	_____.	_____.
0296	SPV.0060 Special 31. Bend 45-Degree 8-Inch Special	4.000 EACH	_____.	_____.
0298	SPV.0060 Special 32. Bend 45-Degree 10-Inch Special	4.000 EACH	_____.	_____.
0300	SPV.0060 Special 33. Bend 90-Degree 6-Inch Special	1.000 EACH	_____.	_____.
0302	SPV.0060 Special 34. Reducer 8"x4" Special	2.000 EACH	_____.	_____.
0304	SPV.0060 Special 35. Reducer 8"x6" Special	3.000 EACH	_____.	_____.
0306	SPV.0060 Special 36. Reducer 10"x8" Special	2.000 EACH	_____.	_____.
0308	SPV.0060 Special 37. Connect to Existing Watermain	9.000 EACH	_____.	_____.
0310	SPV.0060 Special 38. Corporation, Curb Stop & Box (Set)	58.000 EACH	_____.	_____.
0312	SPV.0060 Special 39. Water Service Reconnection	58.000 EACH	_____.	_____.



Proposal Schedule of Items

Proposal ID: 20211214021 Project(s): 6995-00-13, 6995-00-14

Federal ID(s): WISC 2022081, N/A

SECTION: 0001 Roadway Items

Alt Set ID: Alt Mbr ID:

Proposal Line Number	Item ID Description	Approximate Quantity and Units	Unit Price	Bid Amount
0314	SPV.0060 Special 40. Utility Line Opening (ULO)	15.000 EACH	_____.	_____.
0316	SPV.0060 Special 41. Inlet Cover Type Driveway Special	3.000 EACH	_____.	_____.
0318	SPV.0060 Special 42. Temporary Water Service Project 6995-00-14	1.000 EACH	_____.	_____.
0320	SPV.0060 Special 43. Abandon/Remove Sanitary Sewer Project 6995-00-14	1.000 EACH	_____.	_____.
0322	SPV.0060 Special 44. Abandon/Remove Water Main Project 6995-00-14	1.000 EACH	_____.	_____.
0324	SPV.0090 Special 01. Sanitary Sewer Pipe 8-Inch Special	50.000 LF	_____.	_____.
0326	SPV.0090 Special 02. Sanitary Sewer Pipe 10-Inch Special	70.000 LF	_____.	_____.
0328	SPV.0090 Special 03. Sanitary Sewer Pipe 24-Inch Special	1,570.000 LF	_____.	_____.
0330	SPV.0090 Special 04. Sanitary Sewer Pipe 30-Inch Special	660.000 LF	_____.	_____.
0332	SPV.0090 Special 05. Sanitary Lateral 6-Inch	1,470.000 LF	_____.	_____.
0334	SPV.0090 Special 06. Sanitary Sewer Televising	2,335.000 LF	_____.	_____.
0336	SPV.0090 Special 07. PVC Water Main 4-Inch Special	20.000 LF	_____.	_____.
0338	SPV.0090 Special 08. PVC Water Main 6-Inch Special	80.000 LF	_____.	_____.
0340	SPV.0090 Special 09. PVC Water Main 8-Inch Special	2,370.000 LF	_____.	_____.



Proposal Schedule of Items

Proposal ID: 20211214021 Project(s): 6995-00-13, 6995-00-14

Federal ID(s): WISC 2022081, N/A

SECTION: 0001 Roadway Items

Alt Set ID: Alt Mbr ID:

Proposal Line Number	Item ID Description	Approximate Quantity and Units	Unit Price	Bid Amount
0342	SPV.0090 Special 10. PVC Water Main 10-Inch Special	140.000 LF	_____.	_____.
0344	SPV.0090 Special 11. Water Service 1 to 2-Inch Special	1,540.000 LF	_____.	_____.
Section: 0001			Total:	_____.
			Total Bid:	_____.