

# HIGHWAY WORK PROPOSAL

Wisconsin Department of Transportation  
 DT1502 01/2020 s.66.0901(7) Wis. Stats

Proposal Number: **004**

<u>COUNTY</u>	<u>STATE PROJECT</u>	<u>FEDERAL</u>	<u>PROJECT DESCRIPTION</u>	<u>HIGHWAY</u>
Brown	4085-62-71	WISC 2023005	City Of De Pere, Greenleaf Road; Sth 32 Northbound Over Cth Pp	STH 032

## ADDENDUM REQUIRED ATTACHED AT BACK

This proposal, submitted by the undersigned bidder to the Wisconsin Department of Transportation, is in accordance with the advertised request for proposals. The bidder is to furnish and deliver all materials, and to perform all work for the improvement of the designated project in the time specified, in accordance with the appended Proposal Requirements and Conditions.

Proposal Guaranty Required: \$75,000.00 Payable to: Wisconsin Department of Transportation	Attach Proposal Guaranty on back of this PAGE.
Bid Submittal Date: October 11, 2022 Time (Local Time): 11:00 am	Firm Name, Address, City, State, Zip Code  <h3 style="margin: 0;">SAMPLE</h3> <h3 style="margin: 0;">NOT FOR BIDDING PURPOSES</h3>
Contract Completion Time 55 Working Days	This contract is exempt from federal oversight.
Assigned Disadvantaged Business Enterprise Goal <span style="float: right;">1%</span>	

This certifies that the undersigned bidder, duly sworn, is an authorized representative of the firm named above; that the bidder has examined and carefully prepared the bid from the plans, Highway Work Proposal, and all addenda, and has checked the same in detail before submitting this proposal or bid; and that the bidder or agents, officer, or employees have not, either directly or indirectly, entered into any agreement, participated in any collusion, or otherwise taken any action in restraint of free competitive bidding in connection with this proposal bid.

Do not sign, notarize, or submit this Highway Work Proposal when submitting an electronic bid on the Internet.

Subscribed and sworn to before me this date \_\_\_\_\_

\_\_\_\_\_  
 (Signature, Notary Public, State of Wisconsin)

\_\_\_\_\_  
 (Bidder Signature)

\_\_\_\_\_  
 (Print or Type Name, Notary Public, State Wisconsin)

\_\_\_\_\_  
 (Print or Type Bidder Name)

\_\_\_\_\_  
 (Date Commission Expires)

\_\_\_\_\_  
 (Bidder Title)

Notary Seal

Type of Work: Excavation, Base, Concrete Pavement, HMA Pavement, Curb and Gutter, Beam Guard, Bridge Replacement	<b>For Department Use Only</b>
Notice of Award Dated	Date Guaranty Returned

**PLEASE ATTACH  
PROPOSAL GUARANTY HERE**

**Effective with November 2007 Letting**

**PROPOSAL REQUIREMENTS AND CONDITIONS**

The bidder, signing and submitting this proposal, agrees and declares as a condition thereof, to be bound by the following conditions and requirements.

If the bidder has a corporate relationship with the proposal design engineering company, the bidder declares that it did not obtain any facts, data, or other information related to this proposal from the design engineering company that was not available to all bidders.

The bidder declares that they have carefully examined the site of, and the proposal, plans, specifications and contract forms for the work contemplated, and it is assumed that the bidder has investigated and is satisfied as to the conditions to be encountered, as to the character, quality, and quantities of work to be performed and materials to be furnished, and as to the requirements of the specifications, special provisions and contract. It is mutually agreed that submission of a proposal shall be considered conclusive evidence that the bidder has made such examination.

The bidder submits herewith a proposal guaranty in proper form and amount payable to the party as designated in the advertisement inviting proposals, to be retained by and become the property of the owner of the work in the event the undersigned shall fail to execute the contract and contract bond and return the same to the office of the engineer within fourteen (14) days after having been notified in writing to do so; otherwise to be returned.

The bidder declares that they understand that the estimate of quantities in the attached schedule is approximate only and that the attached quantities may be greater or less in accordance with the specifications.

The bidder agrees to perform the said work, for and in consideration of the payment of the amount becoming due on account of work performed, according to the unit prices bid in the following schedule, and to accept such amounts in full payment of said work.

The bidder declares that all of the said work will be performed at their own proper cost and expense, that they will furnish all necessary materials, labor, tools, machinery, apparatus, and other means of construction in the manner provided in the applicable specifications and the approved plans for the work together with all standard and special designs that may be designed on such plans, and the special provisions in the contract of which this proposal will become a part, if and when accepted. The bidder further agrees that the applicable specifications and all plans and working drawings are made a part hereof, as fully and completely as if attached hereto.

The bidder, if awarded the contract, agrees to begin the work not later than ten (10) days after the date of written notification from the engineer to do so, unless otherwise stipulated in the special provisions.

The bidder declares that if they are awarded the contract, they will execute the contract agreement and begin and complete the work within the time named herein, and they will file a good and sufficient surety bond for the amount of the contract for performance and also for the full amount of the contract for payment.

The bidder, if awarded the contract, shall pay all claims as required by Section 779.14, Statutes of Wisconsin, and shall be subject to and discharge all liabilities for injuries pursuant to Chapter 102 of the Statutes of Wisconsin, and all acts amendatory thereto. They shall further be responsible for any damages to property or injury to persons occurring through their own negligence or that of their employees or agents, incident to the performance of work under this contract, pursuant to the Standard Specifications for Road and Bridge Construction applicable to this contract.

In connection with the performance of work under this contract, the contractor agrees to comply with all applicable state and federal statutes relating to non-discrimination in employment. No otherwise qualified person shall be excluded from employment or otherwise be subject to discrimination in employment in any manner on the basis of age, race, religion, color, gender, national origin or ancestry, disability, arrest or conviction record (in keeping with s.111.32), sexual orientation, marital status, membership in the military reserve, honesty testing, genetic testing, and outside use of lawful products. This provision shall include, but not be limited to the following: employment, upgrading, demotion or transfer; recruitment or recruitment advertising; layoff or termination; rates of pay or other forms of compensation, and selection for training, including apprenticeship. The contractor further agrees to ensure equal opportunity in employment to all applicants and employees and to take affirmative action to attain a representative workforce.

The contractor agrees to post notices and posters setting forth the provisions of the nondiscrimination clause, in a conspicuous and easily accessible place, available for employees and applicants for employment.

If a state public official (section 19.42, Stats.) or an organization in which a state public official holds at least a 10% interest is a party to this agreement, this contract is voidable by the state unless appropriate disclosure is made to the State of Wisconsin Ethics Board.



## Effective with August 2015 Letting

### BID PREPARATION

#### Preparing the Proposal Schedule of Items

##### A General

- (1) Obtain bidding proposals as specified in section 102 of the standard specifications prior to 11:45 AM of the last business day preceding the letting. Submit bidding proposals using one of the following methods:
  1. Electronic bid on the internet.
  2. Electronic bid on a printout with accompanying diskette or CD ROM.
  3. Paper bid under a waiver of the electronic submittal requirements.

- (2) Bids submitted on a printout with accompanying diskette or CD ROM or paper bids submitted under a waiver of the electronic submittal requirements govern over bids submitted on the internet.

- (3) The department will provide bidding information through the department's web site at:  
<https://wisconsindot.gov/Pages/doing-bus/contractors/hcci/bid-let.aspx>

The contractor is responsible for reviewing this web site for general notices as well as information regarding proposals in each letting. The department will also post special notices of all addenda to each proposal through this web site no later than 4:00 PM local time on the Thursday before the letting. Check the department's web site after 5:00 PM local time on the Thursday before the letting to ensure all addenda have been accounted for before preparing the bid. When bidding using methods 1 and 2 above, check the Bid Express™ on-line bidding exchange at <http://www.bidx.com/> after 5:00 PM local time on the Thursday before the letting to ensure that the latest schedule of items Expedite file (\*.ebs or \*.00x) is used to submit the final bid.

- (4) Interested parties can subscribe to the Bid Express™ on-line bidding exchange by following the instructions provided at the [www.bidx.com](http://www.bidx.com) web site or by contacting:

Info Tech Inc.  
5700 SW 34th Street, Suite 1235  
Gainesville, FL 32608-5371  
email: <mailto:customer.support@bidx.com>

- (5) The department will address equipment and process failures, if the bidder can demonstrate that those failures were beyond their control.
- (6) Contractors are responsible for checking on the issuance of addenda and for obtaining the addenda. Notice of issuance of addenda is posted on the department's web site at:  
<https://wisconsindot.gov/Pages/doing-bus/contractors/hcci/bid-let.aspx>

or by calling the department at (608) 266-1631. Addenda can ONLY be obtained from the departments web site listed above or by picking up the addenda at the Bureau of Highway Construction, 4<sup>th</sup> floor, 4822 Madison Yards Way, Madison, WI, during regular business hours.

- (7) Addenda posted after 5:00 PM on the Thursday before the letting will be emailed to the eligible bidders for that proposal. All eligible bidders shall acknowledge receipt of the addenda whether they are bidding on the proposal or not. Not acknowledging receipt may jeopardize the awarding of the project.

##### B Submitting Electronic Bids

###### B.1 On the Internet

- (1) Do the following before submitting the bid:
  1. Have a properly executed annual bid bond on file with the department.

2. Have a digital ID on file with and enabled by Info Tech Inc. Using this digital ID will constitute the bidder's signature for proper execution of the bidding proposal.
- (2) In lieu of preparing, delivering, and submitting the proposal as specified in 102.6 and 102.9 of the standard specifications, submit the proposal on the internet as follows:
  1. Download the latest schedule of items reflecting all addenda from the Bid Express™ web site.
  2. Use Expedite™ software to enter a unit price for every item in the schedule of items.
  3. Submit the bid according to the requirements of Expedite™ software and the Bid Express™ web site. Do not submit a bid on a printout with accompanying diskette or CD ROM or a paper bid. If the bidder does submit a bid on a printout with accompanying diskette or a paper bid in addition to the internet submittal, the department will disregard the internet bid.
  4. Submit the bid before the hour and date the Notice to Contractors designates.
  5. Do not sign, notarize, and return the bidding proposal described in 102.2 of the standard specifications.
- (3) The department will not consider the bid accepted until the hour and date the Notice to Contractors designates.

## **B.2 On a Printout with Accompanying Diskette or CD ROM**

- (1) Download the latest schedule of items from the Wisconsin pages of the Bid Express™ web site reflecting the latest addenda posted on the department's web site at:  
<https://wisconsindot.gov/Pages/doing-bus/contractors/hcci/bid-let.aspx>  
Use Expedite™ software to prepare and print the schedule of items. Provide a valid amount for all price fields. Follow instructions and review the help screens provided on the Bid Express™ web site to assure that the schedule of items is prepared properly.
- (2) Staple an 8 1/2 by 11 inch printout of the Expedite™ generated schedule of items to the other proposal documents submitted to the department as a part of the bidder's sealed bid. As a separate submittal, not in the sealed bid envelop but due at the same time and place as the sealed bid, also provide the Expedite™ generated schedule of items on a 3 1/2 inch computer diskette or CD ROM. Label each diskette or CD ROM with the bidder's name, the 4 character department-assigned bidder identification code from the top of the bidding proposal, and a list of the proposal numbers included on that diskette or CD ROM as indicated in the following example:

**Bidder Name**

**BN00**

**Proposals: 1, 12, 14, & 22**

- (3) If bidding on more than one proposal in the letting, the bidder may include all proposals for that letting on one diskette or CD ROM. Include only submitted proposals with no incomplete or other files on the diskette or CD ROM.
- (4) The bidder-submitted printout of the Expedite™ generated schedule of items is the governing contract document and must conform to the requirements of section 102 of the standard specifications. If a printout needs to be altered, cross out the printed information with ink or typewriter and enter the new information and initial it in ink. If there is a discrepancy between the printout and the diskette or CD ROM, the department will analyze the bid using the printout information.
- (5) In addition to the reasons specified in section 102 of the standard specifications, proposals are irregular and the department may reject them for one or more of the following:
  1. The check code printed on the bottom of the printout of the Expedite™ generated schedule of items is not the same on each page.
  2. The check code printed on the printout of the Expedite™ generated schedule of items is not the same as the check code for that proposal provided on the diskette or CD ROM.

3. The diskette or CD ROM is not submitted at the time and place the department designates.

### **C Waiver of Electronic Submittal**

- (1) The bidder may request a waiver of the electronic submittal requirements. Submit a written request for a waiver in lieu of bids submitted on the internet or on a printout with accompanying diskette or CD ROM. Use the waiver that was included with the paper bid document sent to the bidder or type up a waiver on the bidder's letterhead. The department will waive the electronic submittal requirements for a bidding entity (individual, partnership, joint venture, corporation, or limited liability company) for up to 4 individual proposals in a calendar year. The department may allow additional waivers for equipment malfunctions.
- (2) Submit a schedule of items on paper conforming to section 102 of the standard specifications. The department charges the bidder a \$75 administrative fee per proposal, payable at the time and place the department designates for receiving bids, to cover the costs of data entry. The department will accept a check or money order payable to: "Wisconsin, Dept. of Transportation."
- (3) In addition to the reasons specified in section 102 of the standard specifications, proposals are irregular and the department may reject them for one or more of the following:
  1. The bidder fails to provide the written request for waiver of the electronic submittal requirements.
  2. The bidder fails to pay the \$75 administrative fee before the time the department designates for the opening of bids unless the bidder requests on the waiver that they be billed for the \$75.
  3. The bidder exceeds 4 waivers of electronic submittal requirements within a calendar year.
- (4) In addition to the reasons specified in section 102 of the standard specifications, the department may refuse to issue bidding proposals for future contracts to a bidding entity that owes the department administrative fees for a waiver of electronic submittal requirements.

**PROPOSAL BID BOND**

DT1303 1/2006

Wisconsin Department of Transportation

Proposal Number	Project Number	Letting Date
Name of Principal		
Name of Surety	State in Which Surety is Organized	

We, the above-named Principal and the above-named Surety, are held and firmly bound unto the State of Wisconsin in the sum equal to the Proposal Guaranty for the total bid submitted for the payment to be made; we jointly and severally bind ourselves, our heirs, executors, administrators, successors and assigns. The condition of this obligation is that the Principal has submitted a bid proposal to the State of Wisconsin acting through the Department of Transportation for the improvement designated by the Proposal Number and Letting Date indicated above.

If the Principal is awarded the contract and, within the time and manner required by law after the prescribed forms are presented for signature, enters into a written contract in accordance with the bid, and files the bond with the Department of Transportation to guarantee faithful performance and payment for labor and materials, as required by law, or if the Department of Transportation shall reject all bids for the work described, then this obligation shall be null and void; otherwise, it shall be and remain in full force and effect. In the event of failure of the Principal to enter into the contract or give the specified bond, the Principal shall pay to the Department of Transportation **within 10 business days of demand** a total equal to the Proposal Guaranty as liquidated damages; the liability of the Surety continues for the full amount of the obligation as stated until the obligation is paid in full.

The Surety, for value received, agrees that the obligations of it and its bond shall not be impaired or affected by any extension of time within which the Department of Transportation may accept the bid; and the Surety does waive notice of any such extension.

IN WITNESS, the Principal and Surety have agreed and have signed by their proper officers and have caused their corporate seals to be affixed this date: **(DATE MUST BE ENTERED)**

**PRINCIPAL**

\_\_\_\_\_  
(Company Name) **(Affix Corporate Seal)**

\_\_\_\_\_  
(Signature and Title)

\_\_\_\_\_  
(Company Name)

\_\_\_\_\_  
(Signature and Title)

\_\_\_\_\_  
(Company Name)

\_\_\_\_\_  
(Signature and Title)

\_\_\_\_\_  
(Company Name)

\_\_\_\_\_  
(Signature and Title)

\_\_\_\_\_  
(Name of Surety) **(Affix Seal)**

\_\_\_\_\_  
(Signature of Attorney-in-Fact)

**NOTARY FOR PRINCIPAL**

**NOTARY FOR SURETY**

\_\_\_\_\_  
(Date)

\_\_\_\_\_  
(Date)

State of Wisconsin )  
) ss.  
\_\_\_\_\_ County )

State of Wisconsin )  
) ss.  
\_\_\_\_\_ County )

On the above date, this instrument was acknowledged before me by the named person(s).

On the above date, this instrument was acknowledged before me by the named person(s).

\_\_\_\_\_  
(Signature, Notary Public, State of Wisconsin)

\_\_\_\_\_  
(Signature, Notary Public, State of Wisconsin)

\_\_\_\_\_  
(Print or Type Name, Notary Public, State of Wisconsin)

\_\_\_\_\_  
(Print or Type Name, Notary Public, State of Wisconsin)

\_\_\_\_\_  
(Date Commission Expires)

\_\_\_\_\_  
(Date Commission Expires)

**Notary Seal**

**Notary Seal**

**IMPORTANT: A certified copy of Power of Attorney of the signatory agent must be attached to the bid bond.**

# CERTIFICATE OF ANNUAL BID BOND

DT1305 8/2003

Wisconsin Department of Transportation

Time Period Valid (From/To)
Name of Surety
Name of Contractor
Certificate Holder Wisconsin Department of Transportation

This is to certify that an annual bid bond issued by the above-named Surety is currently on file with the Wisconsin Department of Transportation.

This certificate is issued as a matter of information and conveys no rights upon the certificate holder and does not amend, extend or alter the coverage of the annual bid bond.

**Cancellation:** Should the above policy be cancelled before the expiration date, the issuing surety will give thirty (30) days written notice to the certificate holder indicated above.

\_\_\_\_\_  
(Signature of Authorized Contractor Representative)

\_\_\_\_\_  
(Date)





**DECEMBER 2000**

**CERTIFICATION REGARDING DEBARMENT, SUSPENSION, AND OTHER  
RESPONSIBILITY MATTERS - PRIMARY COVERED TRANSACTIONS**

Instructions for Certification

1. By signing and submitting this proposal, the prospective contractor is providing the certification set out below.
2. The inability of a person to provide the certification required below will not necessarily result in denial of participation in this covered transaction. The prospective contractor shall submit an explanation of why it cannot provide the certification set out below. The certification or explanation will be considered in connection with the department or agency's determination whether to enter into this transaction. However, failure of the prospective contractor to furnish a certification or an explanation shall disqualify such person from participation in this transaction.
3. The certification in this clause is a material representation of fact upon which reliance was placed when the department determined to enter into this transaction. If it is later determined that the contractor knowingly rendered an erroneous certification in addition to other remedies available to the Federal Government the department may terminate this transaction for cause or default.
4. The prospective contractor shall provide immediate written notice to the department to whom this proposal is submitted if at any time the prospective contractor learns that its certification was erroneous when submitted or has become erroneous by reason of changed circumstances.
5. The terms "covered transaction," "debarred," "suspended," "ineligible," "lower tier covered transaction," "participant," "person," "primary covered transaction," "principal," "proposal," and "voluntarily excluded," as used in this clause, have the meanings set out in the Definitions and Coverage sections of the rules implementing Executive Order 12549. You may contact the department to which this proposal is being submitted for assistance in obtaining a copy of those regulations.
6. The prospective contractor agrees by submitting this proposal that, should this contract be entered into, it shall not knowingly enter into any lower tier covered transaction with a person who is debarred, suspended, declared ineligible, or voluntarily excluded from participation in this covered transaction, unless authorized by the department entering into this transaction.
7. The prospective contractor further agrees by submitting this proposal that it will include the clause titled "Certification Regarding Debarment, Suspension, Ineligibility and Voluntary Exclusion-Lower Tier Covered Transaction," which is included as an addendum to PR-1273 - "Required Contract Provisions Federal Aid Construction Contracts," without



modification, in all lower tier covered transactions and in all solicitations for lower tier covered transactions.

8. The contractor may rely upon a certification of a prospective subcontractor/materials supplier that it is not debarred, suspended, ineligible, or voluntarily excluded from the covered transaction, unless it knows that the certification is erroneous. A contractor may decide the method and frequency by which it determines the eligibility of its principals. Each contractor may, but is not required to, check the Disapproval List (telephone # 608/266/1631).
9. Nothing contained in the foregoing shall be construed to require establishment of a system of records in order to render in good faith the certification required by this clause. The knowledge and information of a contractor is not required to exceed that which is normally possessed by a prudent person in the ordinary course of business dealings.
10. Except for transactions authorized under paragraph 6 of these instructions, if a contractor in a covered transaction knowingly enters into a lower tier covered transaction with a person who is suspended, debarred, ineligible or voluntarily excluded from participation in this transaction, in addition to other remedies available to the Federal Government, the department may terminate this transaction for cause or default.

Certification Regarding Debarment, Suspension, and Other Responsibility Matters - Primary Covered Transactions

- (1) The prospective contractor certifies to the best of its knowledge and belief, that it and its principals:
  - (a) Are not presently debarred, suspended, proposed for debarment, declared ineligible, or voluntarily excluded from covered transactions by any Federal department or agency;
  - (b) Have not within a three-year period preceding this proposal been convicted of or had a civil judgment rendered against them for commission of fraud or a criminal offense in connection with obtaining, attempting to obtain, or performing a public (Federal, State or local) transaction or contract under a public transaction; violation of Federal or State antitrust statutes or commission of embezzlement, theft, forgery, bribery, falsification or destruction of records, making false statements or receiving stolen property;
  - (c) Are not presently indicted for or otherwise criminally or civilly charged by a governmental entity (Federal, State or local) with commission of any of the offense enumerated in paragraph (1)(b) of this certification; and
  - (d) Have not within a three-year period preceding this proposal had one or more public transactions (Federal, State or local) terminated for cause or default.
- (2) Where the prospective contractor is unable to certify to any of the statements in this certification, such prospective contractor shall attach an explanation to this proposal.

## Special Provisions

### Table of Contents

<b>Article</b>	<b>Description</b>	<b>Page #</b>
1.	General.....	2
2.	Scope of Work.....	2
3.	Prosecution and Progress.....	2
4.	Traffic.....	2
5.	Holiday and Special Event Work Restrictions.....	3
6.	Utilities.....	4
7.	Notice to Contractor, Notification of Demolition and/or Renovation No Asbestos Found.....	4
8.	Temporary Slope Drain, Item SPV.0060.100.....	5
9.	Removing Existing Steel Piling, Item SPV.0090.100.....	5

## STSP'S Revised January 7, 2022

### SPECIAL PROVISIONS

#### 1. General.

Perform the work under this construction contract for Project 4085-62-71, City of De Pere, Greenleaf Road; STH 32 Northbound over CTH PP, STH 32, Brown County, Wisconsin as the plans show and execute the work as specified in the State of Wisconsin, Department of Transportation, Standard Specifications for Highway and Structure Construction, 2022 Edition, as published by the department, and these special provisions.

If all or a portion of the plans and special provisions are developed in the SI metric system and the schedule of prices is developed in the US standard measure system, the department will pay for the work as bid in the US standard system.

100-005 (20220107)

#### 2. Scope of Work.

The work under this contract shall consist of removing asphalt, removing concrete, asphaltic pavement, concrete pavement, roadway aggregate, aggregate shoulders, beam guard replacement, beam guard grading, structure grading, bridge removal, bridge replacement, pavement marking, and all incidental items necessary to complete the work as shown on the plans and included in the proposal and contract.

104-005 (20090901)

#### 3. Prosecution and Progress.

Begin work within 10 calendar days after the engineer issues a written notice to do so.

Provide the time frame for construction of the project within the 2023 construction season to the engineer in writing within a month after executing the contract but at least 14 calendar days before the preconstruction conference. Assure that the time frame is consistent with the contract completion time. Upon approval, the engineer will issue the notice to proceed within 10 calendar days before the beginning of the approved time frame.

To revise the time frame, submit a written request to the engineer at least two weeks before the beginning of the intended time frame. The engineer will approve or deny that request based on the conditions cited in the request and its effect on the department's scheduled resources.

##### **Northern Long-eared Bat (*Myotis septentrionalis*)**

Northern Long-eared Bats (NLEB) have the potential to inhabit the project limits because they roost in trees. Roosts may not have been observed on this project, but conditions to support the species exist. The species and all active roosts are protected by the Federal Endangered Species Act. If an individual bat or active roost is encountered during construction operations, stop work and notify the engineer and the WisDOT Regional Environmental Coordinator (REC).

If additional construction activities beyond what was originally specified are required to complete the work, approval from the engineer, following coordination with WisDOT REC, is required prior to initiating these activities.

#### 4. Traffic.

Detour STH 32 northbound traffic and CTH PP southbound traffic during construction operations under this contract.

The detour route for northbound STH 32 will be STH 32/Greenleaf Road to CTH X/Heritage Road to CTH PP/S Broadway Drive to STH 32.

The detour route for southbound CTH PP will be CTH PP/STH 32 to STH 32/Greenleaf Road to CTH X/Heritage Road to CTH PP/S Broadway Drive.

## Wisconsin Lane Closure System Advance Notification

Provide the following advance notification to the engineer for incorporation into the Wisconsin Lane Closure System (LCS).

**TABLE 108-1 CLOSURE TYPE AND REQUIRED MINIMUM ADVANCE NOTIFICATION**

<b>Closure type with height, weight, or width restrictions (available width, all lanes in one direction &lt; 16 feet)</b>	<b>MINIMUM NOTIFICATION</b>
Lane and shoulder closures	7 calendar days
Full roadway closures	7 calendar days
Ramp closures	7 calendar days
Detours	7 calendar days
<b>Closure type without height, weight, or width restrictions (available width, all lanes in one direction ≥ 16 feet)</b>	<b>MINIMUM NOTIFICATION</b>
Lane and shoulder closures	3 business days
Ramp closures	3 business days
Modifying all closure types	3 business days

Discuss LCS completion dates and provide changes in the schedule to the engineer at weekly project meetings in order to manage closures nearing their completion date.

### Portable Changeable Message Signs – Message Prior Approval

After coordinating with department construction field staff, notify the Northeast Region Traffic Section at 920-366-8033 (secondary contact number is (920) 360-3107) 3 business days before deploying or changing a message on a PCMS to obtain approval of the proposed message. The Northeast Region Traffic Unit will review the proposed message and either approve the message or make necessary changes.

PCMS boards must be deployed 7 days before the closure of STH 32 and CTH PP.

ner-643-035 (20171213)

## 5. Holiday and Special Event Work Restrictions.

Do not perform work on, nor haul materials of any kind along or across any portion of the highway carrying STH 32 traffic, and entirely clear the traveled way and shoulders of such portions of the highway of equipment, barricades, signs, lights, and any other material that might impede the free flow of traffic during the following holiday and special event periods:

- From noon Friday, May 26, 2023 to 6:00 AM Tuesday, May 30, 2023 for Memorial Day;
- From noon Friday, June 30, 2023 to 6:00 AM Wednesday, July 5, 2023 for Independence Day.
- From noon Friday, September 1, 2023 to 6:00 AM Tuesday, September 5, 2023 for Labor Day;
- Green Bay Packers Family Night Scrimmage: From three (3) hours before the scrimmage until three (3) hours after the scrimmage;
- Green Bay Packers home games: From three (3) hours before the game until three (3) hours after the game;
- Lambeau Field events: From eight (8) hours before the event until three (3) hours after the event;

stp-107-005 (20210113)

## 6. Utilities.

This contract comes under the provision of Administrative Rule Trans 220.

stp-107-065 (20080501)

Additional detailed information regarding the location of utility facilities is available at the region WisDOT office during normal working hours.

**AT&T WI** has underground **communication** facilities within the project limits. No conflicts anticipated.

**City of De Pere** has underground **water** facilities within the project limits. No conflicts anticipated.

**Ctrl Brown Cnty Wtr** has underground **water** facilities within the project limits. No conflicts anticipated.

**US Signal Co LLC** has underground **communication** facilities within the project limits. No conflicts anticipated.

**Wisconsin Public Service Corporation (WPS)** has overhead **electric** facilities within the project limits. No conflicts anticipated.

**Wisconsin Public Service Corporation (WPS)** has underground **gas** facilities within the project limits. WPS will relocate a portion of 8" high pressure steel gas main in conflict with the new bridge pier at approx. station 649+66 prior to construction.

## 7. Notice to Contractor, Notification of Demolition and/or Renovation No Asbestos Found.

Paul M. Garvey, License Number ALL-117079, inspected Structure B-05-052 for asbestos on September 18, 2019. No regulated Asbestos Containing Material (RACM) was found on this structure. A copy of the inspection report is available from Kristen Berg, (920) 492-0139.

In accordance with NR447 and DHS159, ensure that DNR or DHS receives a completed Notification of Demolition and/or Renovation (DNR Form 4500-113 (R 4/11), or subsequent revision) via U.S. mail, hand-delivery, or using the online notification system at least 10 working days before beginning any construction or demolition. Pay all associated fees. Provide a copy of the completed 4500-113 form to Kristen Berg, (920) 492-0139, and DOT BTS-ESS attn: Hazardous Materials Specialist, PO Box 7965, Madison, WI 53707-7965. In addition, comply with all local or municipal asbestos requirements.

Use the following information to complete WisDNR form 4500-113:

- Site Name: Structure B-05-052, STH 32 northbound over CTH PP
- Site Address: 4.8M N JCY CTH ZZ TO W
- Ownership Information: WisDOT Northeast Region, 944 Vanderperren Way, Green Bay, WI 54304
- Contact: Kristen Berg
- Phone: (920) 492-0139
- Age: 60 years old. This structure was constructed in 1962.
- Area: 6834 SF of deck

Insert the following paragraph in Section 6.g.:

If asbestos not previously identified is found or previously non-friable asbestos becomes crumbled, pulverized, or reduced to a powder, stop work immediately, notify the engineer, and the engineer will notify the department's Bureau of Technical Services at (608) 266-1476 for an emergency response as specified in standard spec 107.24. Keep material wet until it is abated or until it is determined to be non-asbestos containing material.

stp-107-125 (20120615)

**8. Temporary Slope Drain, Item SPV.0060.100**

**A Description**

This special provision describes providing, maintaining, and removing a temporary slope drain to manage runoff from bridge decks before installation of surface drains, storm sewer, and pavement on the bridge approaches or permanent slope stabilization.

**B (Vacant)**

**C Construction**

Construct temporary slope drain conforming to the details shown in the plan and as required to fit the conditions of each location. Maintain the temporary slope drain at regular intervals or as the engineer directs. At a minimum maintain temporary slope drains until installation of permanent surface drains, storm sewer, and pavement are complete for bridges with finished approaches. Maintain the temporary slope drain at bridges without finished approaches or permanent drainage structures until downstream fill slopes are stabilized to prevent runoff scour.

**D Measurement**

The department will measure Temporary Slope Drain as each individual location installed conforming to the contract and accepted.

**E Payment**

The department will pay for measured quantities at the contract unit price under the following bid item:

ITEM NUMBER	DESCRIPTION	UNIT
SPV.0060.100	Temporary Slope Drain	EACH

Payment is full compensation for furnishing and maintaining all materials, and for removal of the temporary slope drains.

ner-210-015 (20171213)

**9. Removing Existing Steel Piling, Item SPV.0090.100.**

**A Description**

This special provision describes removing existing steel piles that conflict with proposed new piling for substructures as shown on the plans.

**B (Vacant)**

**C Construction**

Remove any existing steel piling that conflicts with proposed piling locations and as shown on the contract plans. An existing steel pile conflicts with a proposed pile if it is within 2.5 proposed-pile diameters (center-to-center spacing) of a proposed pile.

One of the following methods of removing shall be used:

- a. **Direct Pull:** Remove the piling from the soil by pulling directly upward.
- b. **Vibratory Excavation:** Remove the piling by vibrating the piling loose and pulling the piling directly upward
- c. **Contractor Proposed:** If the contractor chooses to use an alternate method to remove the existing steel piling, the contractor shall provide the engineer with a written methodology for review and acceptance.

When an existing steel piling is found to conflict with the proposed location of a new piling, the contractor shall notify the engineer and receive written acceptance on the method of removal that was chosen prior to beginning any work to remove the steel piling.

Backfill any holes left by pile removal with Backfill Granular Grade 1 or 2 before driving the new piling.

**D Measurement**

The department will measure Removing Existing Steel Piling by the linear foot, acceptably completed. Measurement will be made along the vertical length of the steel piling removed.

## E Payment

The department will pay for measured quantities at the contract unit price under the following bid item:

ITEM NUMBER	DESCRIPTION	UNIT
SPV.0090.100	Removing Existing Steel Piling	LF

Payment is full compensation for removing existing steel piling, backfilling and for disposing of all material removed. Any additional excavation necessary is included with the bid item Excavation for Structures.

---

**ADDITIONAL SPECIAL PROVISION 1 (ASP 1)  
FOR TRANSPORTATION ALLIANCE FOR NEW SOLUTIONS (TrANS)  
PROGRAM EMPLOYMENT PLACEMENTS AND APPRENTICESHIPS**

---

The Safe, Accountable, Flexible, Efficient Transportation Equity Act: A Legacy for Users (SAFETEA-LU), Section 5204(e) – Surface Transportation Workforce Development Training and Education, provides for 100 percent Federal funding if the core program funds are used for training, education, or workforce development purposes, including “pipeline” activities. The core programs includes: Congestion Mitigation and Air Quality Improvement (CMAQ) Program, Highway Bridge Program (HBP), Interstate Maintenance (IM), National Highway System (NHS), and Surface Transportation Program (STP). These workforce development activities cover surface transportation workers, including OJT/SS programs for women and minorities as authorized in 23 U.S.C. §140(b).

*TrANS* is an employment program originally established in 1995 in Southeastern Wisconsin. Currently TrANS has expanded to include TrANS program locations to serve contractors in Southeast (Milwaukee and surrounding counties), Southcentral (Dane County and surrounding counties including Rock County), and most Northeastern Wisconsin counties from locations in Keshena, Rhinelander and surrounding far Northern areas. TrANS attempts to meet contractor’s needs in other geographic locations as possible. It is an industry driven plan of services to address the outreach, preparation, placement and retention of women, minorities and non-minorities as laborers and apprentices in the highway skilled trades. These candidate preparation and contractor coordination services are provided by community based organizations. For a list of the TrANS Coordinators contact the Disadvantaged Business Enterprise Office at (414) 438-4583 in Milwaukee or (608) 266-6961 in Madison. These services are provided to you at no cost.

### ***I. BASIC CONCEPTS***

Training reimbursements to employing contractors for new placements, rehires or promotions to apprentice of TrANS Program graduates will be made as follows:

- 1) **On-the-Job Training, Item ASP.1T0G, ASP 1 Graduate.** At the rate of \$5.00 per hour on federal aid projects when TrANS graduates are initially hired, or seasonally rehired, as unskilled laborers or the equivalent.

Eligibility and Duration: To the employing contractor, for up to 2000 hours from the point of initial hire as a TrANS program placement.

Contract Goal: To maintain the intent of the Equal Employment Opportunity program, it is a goal that   2   (*number*) TrANS Graduate(s) be utilized on this contract.

- 2) **On-the-Job Training, Item ASP.1T0A, ASP 1 Apprentice.** At the rate of \$5.00 per hour on federal aid projects at the point when an employee who came out of the TrANS Program is subsequently entered into an apprenticeship contract in an underutilized skilled trade (this will include the Skilled Laborer Apprenticeship when that standard is implemented).



Eligibility and Duration: To the employing contractor, for the length of time the TrANS graduate is in apprentice status.

Contract Goal: To maintain the intent of the Equal Employment Opportunity program, it is a goal that   1   (*number*) TrANS Apprentice(s) be utilized on this contract.

- 3) The maximum duration of reimbursement is two years as a TrANS graduate plus time in apprentice status.
- 4) If a TrANS program is not available in the contractor's area and another training program is utilized, payment of On-the-Job Training hours may be approved by the Wisconsin Department of Transportation (WisDOT) if the training program meets the established acceptance criteria. Only On-the-Job Training Hours accumulated after WisDOT approval will be reimbursed as specified under Items ASP.1T0G and ASP.1T0A. For more information, contact the Disadvantaged Business Enterprise Office at the phone numbers listed above.
- 5) WisDOT reserves the right to deny payments under items ASP.1T0G and ASP.1T0A if the contractor either fails to provide training or there is evidence of a lack of good faith in meeting the requirements of this training special provision.

## **II. RATIONALE AND SPECIAL NOTE**

The \$5.00 per hour now being paid for TrANS placements is intended to cover the duration of two years to allow for reaching entry-level laborer status. An additional incentive, the \$5.00 rate, would promote movement into the underutilized skilled trades' apprenticeships and applies until the individual completes their apprenticeship. These incentives benefit TrANS candidates by giving them a better opportunity to enter a skilled trade; benefits contractors who will be assisted in meeting their EEO profiles and goals; and benefits the public who will see the program reinforce larger public-private employment reform in Wisconsin. The pool of TrANS graduates was created for the purpose of addressing underutilization in the skilled trades, an objective that is further reinforced by a parallel retention pilot program, known as the Companywide Reporting. *Whether or not reimbursement is involved, the WisDOT reassures contractors who are in the Companywide Program that TrANS placements still contribute toward fulfilling the new hire goal of 50% women and minorities.* Based on data administered by United States Department of Labor (US DOL), the highway skilled trades remain underutilized for women statewide (less than 6.9%); and for minorities in all counties (% varies by county).

NOTE: *Unless using other advancement strategies, contractors are encouraged to use some or all of this monetary incentive to offset the cut in hourly wages an individual may incur when entering an apprenticeship if the full general laborer hourly rate has been previously paid. No special accounting measures are required.*

## **III. IMPLEMENTATION**

The implementation of ASP 1 is intended to cover only the amount of time it takes for underutilization to be resolved across the trades. This will be measured annually at the county and/or state levels using data administered by WisDWD in relation to goals set by the USDOL-

OFCCP. With appropriate state and federal approvals, we may also do some measurement at the company level.

It is the contractor's responsibility to note on their Certified Payrolls if their employee is a TrANS graduate or a TrANS apprentice. The District EEO Coordinators utilize the information on the Certified Payrolls to track the hours accumulated by TrANS Graduates and TrANS apprentices on WisDOT contracts. Payment under this ASP 1 is made based on the hours recorded off of the Certified Payrolls. Tracking may eventually include improved linkages with the WisDWD apprentice database, information from company and committee level sources.

TrANS is nondiscriminatory by regulation, and is a tool for optional use by contractors to address the underutilization of women and minorities as laborers and apprentices in our industry's skilled trades.

#### **IV. TRANS TRAINING**

As part of the contractor's equal employment opportunity affirmative action program, training shall be provided to employees enrolled in apprenticeship and on-the-job training programs as follows:

The contractor shall provide on-the-job training aimed at developing full journey workers in the type of trade or job classifications involved. In the event the contractor subcontracts a portion of the contract work, the contractor shall determine how many, if any, of the trainees are to be trained by the subcontractor provided, however, that the contractor shall retain the primary responsibility for meeting the training requirements imposed by this special provision. The contractor shall also insure that this training special provision is made applicable to such subcontract.

Training and upgrading of minorities and women toward journey workers status is a primary objective of this training special provision. Accordingly, the contractor shall make every effort to enroll minority trainees and women (e.g., by conducting systematic and direct recruitment through public and private sources likely to yield minority trainees and women trainees); to the extent such persons are available within a reasonable area of recruitment. The contractor will be given an opportunity and will be responsible for demonstrating the steps that they have taken in pursuance thereof, prior to determination as to whether the contractor is in compliance with this training special provision. This training commitment is not intended, and shall not be used, to discriminate against any applicant for training, whether a member of a minority group or not.

No employee shall be employed as a trainee in any classification in which they have successfully completed a training course leading to journey workers status or in which they have been employed as a journey worker. The contractor should satisfy this requirement by including appropriate questions in the employee application or by other suitable means. Regardless of the method used, the contractor's records should document the findings in each case.

#### **V. APPRENTICESHIP TRAINING**

The Federal Highway Administration's (FHWA) policy is to require full use of all available training and skill improvement opportunities to assure increased participation of minority groups, disadvantaged persons and women in all phases of the highway construction industry. The FHWA On-the-Job Training (OJT) Program requires the State transportation agencies (STAs) to establish apprenticeships and training programs targeted to move women, minorities, and disadvantaged individuals into journey-level positions to ensure that a competent workforce is available to meet highway construction hiring needs, and to address the historical under-representation of members of these groups in highway construction skilled crafts.

The OJT Supportive Services (OJT/SS) Program was established in Title 23 Code of Federal Regulations (CFR), Part 230) to supplement the OJT program and support STA training programs by providing services to highway construction contractors and assistance to highway construction apprentices and trainees. The primary objectives of OJT/SS are:

- (1) To increase the overall effectiveness of the State highway agencies' approved training programs.
- (2) To seek other ways to increase the training opportunities for women, minorities, and disadvantaged individuals.

The STAs are responsible for establishing procedures, subject to the availability of Surface Transportation and Bridge Funds under 23 U.S.C. §140(b) (Nondiscrimination), for the provision of supportive services with respect to training programs approved under 23 CFR, Part 230(a) (Equal Employment Opportunity on Federal and Federal-aid Construction Contracts – including Supportive Services).

The contractor and subcontractor shall maintain records to demonstrate compliance with these apprenticeship requirements. Reasonable exemptions and modifications to and from any or all of these requirements will be determined by the Wisconsin Department of Transportation-Civil Rights Office. A request for an exemption or modification, with justification, shall be made in writing, addressed to WisDOT Civil Rights Office, 4802 Sheboygan Avenue, P.O. Box 7965, Rm. 451, Madison, WI 53707.

## ADDITIONAL SPECIAL PROVISION 3

### DISADVANTAGED BUSINESS ENTERPRISE (DBE) PROGRAM IMPLEMENTATION

#### Authority

Wisconsin Department of Transportation (WisDOT) is a recipient of funds from the US Department of Transportation's Federal Highway Administration. The DBE program is a federal program applicable on all contracts administered by WisDOT that include federal-aid highway funds. The authority for the DBE program is the Transportation Bill as approved by Congress periodically. DBE program guidance and requirements are outlined in the Code of Federal Regulations at 49 CFR Part 26. This contract is subject to DBE provisions because it is financed with federal-aid-highway funds. Additionally, this contract is subject to the *State of Wisconsin Standard Specifications for Highway and Structure Construction* and all applicable contract documents.

#### Requirements

Pursuant to the federal DBE program regulation at 49 CFR Part 26, a contractor's failure to comply with any provision of the DBE program regulatory provisions will be considered a material breach of contract. This is nonnegotiable.

If a contractor fails to carry out the DBE program requirements and/or the Required Contract Provisions for Federal Aid Contracts (FHWA 1273) referenced in this document, sanctions will be assessed depending upon the facts, reasoning, severity, and remedial efforts of the contractor that may include: termination of contract, withholding payment, assessment of monetary sanctions, and/or suspension/debarment proceedings that could result in the disqualification of the contractor from bidding for a designated period of time.

- (1) The Commitment to Subcontract to DBE (Form DT1506 or digital submittal), Attachments A, and Good Faith Effort Documentation (Form DT1202) will be submitted as described in Section 2.
- (2) Any change to DBE Commitments thereafter must follow modification of DBE subcontracting commitment as described in Section 9.
- (3) The Department requires this list of DBE subcontractors from all bidders at time of bid to ensure the lowest possible cost to taxpayers and fairness to other bidders and subcontractors. Bid shopping is prohibited.
- (4) The contractor must utilize the specific DBE firms listed in the approved DBE Commitment to perform the work and/or supply the materials for which the DBE firm is listed unless the contractor obtains written consent in advance from WisDOT. The contractor will not be entitled to payment for any work or materials on the approved DBE Commitment that is not performed or supplied by the listed DBE without WisDOT's written consent.

#### Description

The Wisconsin Department of Transportation is committed to the compliant administration of the DBE Program. The DBE provisions work in tandem with FHWA 1273 and WisDOT's *Standard Specifications for Highway and Structure Construction* and *Construction and Materials Manual*. The WisDOT Secretary is signatory to assurances of department-wide compliance.

The Department assigns the contract DBE goal as a percentage of work items that could be performed by certified DBE firms on the contract. The assigned DBE goal is expressed on the bid proposal as a percentage applicable to the total contract bid amount.

- (1) WisDOT identifies the assigned DBE goal in its contract advertisements and posts the contract DBE goal on the cover of the bidding proposal. The contractor can meet the assigned contract DBE goal by subcontracting work to a DBE firm or by procuring services or materials from a DBE firm.

- (2) Under the contract, the prime contractor should inform, advise, and develop participating DBE firms to be more knowledgeable contractors who are prepared to successfully complete their contractual agreement through the proactive provision of assistance in the following areas:
  - Produce accurate and complete quotes
  - Understand highway plans applicable to their work
  - Understand specifications and contract requirements applicable to their work
  - Understand contracting reporting requirements
- (3) The Department encourages contractors to assist DBE subcontractors more formally by participating in WisDOT's Business Development program as a mentor, coach, or resource. For comprehensive information on the Disadvantaged Business Enterprise Program, visit the Department's Civil Rights and Compliance Section website at: <http://wisconsindot.gov/Pages/doing-bus/civil-rights/dbe/default.aspx>

## 1. Definitions

Interpret these terms, used throughout this additional special provision, as follows:

- a. **Assigned DBE Contract Goal:** The percentage shown on the cover of the Highway Work Proposal that represents the feasible level of DBE participation for each contract. The goal is calculated using the Engineer's Estimate and DBE Interest Report. Goal assignment includes review of FHWA funds, analyzes bid items for subcontract opportunity and compatibility with DBE certified firm work codes. Additional factors considered include proximity, proportion, and regulations.
- b. **Bid Shopping:** In construction law, bid shopping is the practice of divulging a subcontractor's bid to another prospective contractor(s) before or after the award of a contract to secure a lower bid.
- c. **DBE:** Disadvantaged Business Enterprise – A for-profit small business concern where socially and economically disadvantaged individuals own at least a 51% interest and control management and daily business operations.
- d. **DBE Commitment:** The DBE Commitment is identified in the Commitment to Subcontract to DBE (Form DT1506) and is expressed as the amount of DBE participation the prime contractor has secured. The DT1506, a contract document completed by the bidder, is required to be considered a responsive bidder on an FHWA-funded contract that has an assigned DBE goal. The prime contractor will have the option to submit the DT1506 digitally, as an entry with the bid in Bid Express, or as an attachment to the bid.
- e. **DBE Utilization:** The actual participation of a DBE subcontractor on a project. WisDOT verifies DBE utilization through review of the DBE Commitment, payments to subcontractors, and contract documentation. The Prime Contractor receives DBE credit for payments made to the DBE firms performing the work listed on the approved DBE Commitment, and those submitted after approved commitment with Attachment A.
- f. **Good Faith Effort:** Legal term describing a diligent and honest effort taken by a reasonable person under the same set of facts or circumstances. For DBE subcontracting, the bidder must show that it took all necessary and reasonable steps to achieve the assigned DBE goal by the scope, intensity, and appropriateness of effort that could reasonably be expected for a contractor to obtain sufficient DBE participation.
- g. **Manufacturer:** A firm that operates or maintains a factory or establishment that produces, on the premises, the materials, supplies, articles, or equipment required under the contract.

- h. **Reasonable Price:** Contractors are expected to assess reasonable price by analyzing the contract scope for DBE subcontract feasibility and comparing common line items in DBE and non-DBE subcontract quotes for the same work. Per federal regulation, reasonable price is not necessarily the lowest price.
- i. **Supplier:** A firm that owns, operates, or maintains a store, warehouse, or other establishment in which the materials, supplies, articles, or equipment required under the contract are bought, kept in stock, and regularly sold or leased to the public.
- j. **Tied quote:** Subcontractor quote that groups multiple bid/line items at a bundled/package price with a notation that the items within the quote will not be separated.

## 2. WisDOT DBE Program Compliance

### a. Documentation Submittal

- The Commitment to Subcontract to DBE (Form DT1506 or digital submittal) must be submitted at the time of bid (Tuesday) by all prime contractors.
- Attachments A OR quotes from all DBEs included in the Commitment must be submitted at bid (Tuesday) **OR**
- Within one-hour following bid submittal by ALL prime contractors via eSubmit (Tuesday).
- If only DBE quotes were submitted, all remaining signed Attachments A must be submitted within 24-hours of bid closing via eSubmit (Wednesday).
- If the assigned DBE contract goal is not met, Documentation of Good Faith Effort (Form DT1202) and supporting documentation must be submitted within 24-hours of bid closing (Wednesday) via eSubmit. [Instructions for eSubmit.](#)

\*\*Bidders have the option of submitting the DBE Commitment at the time of bid via direct entry through Bid Express OR with attachment of Form DT1506 (Commitment to Subcontract to DBE). The DBE Commitment entered with bid is the digital form of the DT1506. Separate submission of Form DT1506 is not required if the DBE Commitment is entered in Bid Express. Form DT1202, if applicable, is no longer required to be submitted at time of bid; submit DT1202 within the 24-hour supplemental time frame following bid closing.

The DBE Office will not certify Good Faith Effort and the Bureau of Project Development will consider the bid nonresponsive if the contractor fails to furnish the DBE Commitment (digitally entered into the bid OR Form DT1506 as an attachment), Attachments A, and Form DT1202 if applicable, as required. See sample forms in the Appendix.

### b. Verification of DBE Commitment

The documentation related to DBE subcontract commitment submitted prior to contract award is evaluated as follows:

#### (1) DBE Goal Met

If the bidder indicates that the contract DBE goal is met, the Department will evaluate the DBE Commitment submitted with bid OR Form DT1506, and Attachments A to verify the actual DBE percentage calculation. If the DBE Commitment is verified, the contract is eligible for award with respect to the DBE Commitment.

#### (2) DBE Goal Not Met

- a) If the bidder indicates a bid percentage on the DBE Commitment that does not meet the assigned DBE contract goal, the bidder must request alternative evaluation of good faith effort through

- submission of Form DT1202 (Documentation of Good Faith Effort) within 24-hours of bid including narrative description. Supplementary documentation of good faith effort that supports the DT1202 submission is also due within 24-hours of bid submission and prior to bid posting. The Department will review the bidder's DBE Commitment and evaluate the bidder's good faith efforts submission.
- b) Following evaluation of the bidder's Good Faith Effort documentation the bidder will be notified that the Department intends to:
    1. *Approve* the request (adequate documentation of GFE has been submitted) - no conditions placed on the contract with respect to the DBE Commitment;
    2. *Deny* the request (inadequate documentation of GFE has been submitted) - the contract is viewed as non-responsive per Wisconsin Standard Specifications for Highway and Structure Construction and will not be executed.
  - c) If the Department denies the bidder's request, the contract is ineligible for award. The Department will provide a written explanation for denying the request to the bidder. The bidder may appeal the Department's denial (see Section 4).

Supplemental good faith effort documentation must be submitted through eSubmit.

### 3. Department's Criteria for Good Faith Effort Documentation

The Federal-aid Construction Contract Provision, referenced as FHWA-1273, explicitly states that the prime contractor shall be responsible for all work performed on the contract by piecework, station work, or subcontract. The contractor shall take all necessary and reasonable steps to ensure nondiscrimination in the administration of the contract including assurances of equal employment opportunity laws, DBE regulations, and affirmative action. Compliance encompasses responsible and responsive action, documentation, and good faith effort.

Contractually, all contractors, subcontractors, and service providers on the contract are bound by FHWA 1273 and DBE program provisions. **Prime contractors should encourage subcontractors to utilize DBE firms whenever possible to contribute to the assigned DBE contract goal.**

Bidders are required to document good faith effort. Per 49 CFR Part 26.53, good faith effort is demonstrated in one of two ways. The bidder:

- (1) Documents that it has obtained enough DBE participation to meet the goal; OR
- (2) Documents that it made adequate good faith efforts to meet the goal, even though it did not succeed

*Appendix A* of 49 CFR Part 26 provides guidance concerning good faith efforts. WisDOT evaluates good faith effort on a contract basis just as each contract award is evaluated individually.

The efforts employed by the bidder should be those that WisDOT can reasonably expect a bidder to take to actively and aggressively obtain DBE participation sufficient to meet the DBE contract goal. The Department will only approve demonstration of good faith effort if the bidder documents the quality, quantity, and intensity of the variety of activities undertaken that are commensurate with expected efforts to meet the stated goal.

The Department, in conjunction with industry stakeholders, has developed the following guidance for contractor good faith effort activity. The guidance and the attached appendices provide a framework for the actions required by all parties in the processing and evaluation of bidder's total efforts to achieve the project specific DBE goal prior to the bid letting date.

**a. Solicitation Guidance for Prime Contractors:**

- (1) Document all efforts and decisions made toward achieving the DBE goal on the contract. The bidder should use WisDOT-approved DBE outreach tools, including the UCP DBE Directory and the Bid Express Small Business Network to foster DBE participation on all applicable contracts.
- (2) As needed, request assistance with DBE outreach and follow-up by contacting the Department's DBE Support Services Office by phone or email request at least 14 days prior to the bid letting date. Phone numbers are (414) 438-4584 and/or (608) 267-3849; Fax: (414) 438-5392; E-mail: [DBE\\_Alert@dot.wi.gov](mailto:DBE_Alert@dot.wi.gov)
- (3) Participate in and document a substantive conversation with at least one DBE firm per Let, to discuss questions, concerns, and any other contract related matters that may be applicable to the DBE firm. Guidelines for this conversation are provided in Appendix A of ASP-3.
- (4) Request quotes by identifying potential items to subcontract and solicit. In their initial contacts, contractors are strongly encouraged to include a single page, detailed list of items for which they are accepting quotes, by project, within a letting. *See attached sample entitled "Sample Contractor Solicitation Letter" in Appendix B.* Prime contractors should also indicate a willingness to accept quotes in areas they are planning to perform themselves, as required by federal rules. In some cases, it might be appropriate to use DBE firms to do work in a prime contractor's area of specialization.
  - i. Solicit quotes from certified DBE firms who match possible items to subcontract using all reasonable and available means. Additionally, forward copies of solicitations highlighting the work areas for which quotes are being sought to [DBE\\_Alert@dot.wi.gov](mailto:DBE_Alert@dot.wi.gov)
  - ii. Acceptable outreach tools include SBN (Small Business Network, see Appendix C): <https://www.bidx.com/wi/main>, postal mail, email, fax, and phone.
    - a. Contractors must ask DBE firms for a response in their solicitations. *See Sample Contractor Solicitation Letter, Appendix B.* This letter may be included as an attachment to the sub-quote request.
    - b. Solicit quotes at least 10 calendar days prior to the letting date to allow DBE firms sufficient time to respond. Prime contractors should contact DBE firms early, asking if they need help organizing their quote, assistance confirming equipment needs, or other assistance supporting their submission of a competitive quote for their services.
    - c. A follow up solicitation should take place within 5 calendar days of the letting date. Email and/or SBN are the preferred method for the solicitation.
  - iii. Upon request, provide interested DBE firms with adequate information about plans, specifications, and the requirements of the contract by letter, information session, email, phone call, and/or referral.
  - iv. When potential exists, the contractor should advise interested DBE firms on how to obtain bonding, line of credit, or insurance if requested.
  - v. Document DBE firm's interest in quoting by taking appropriate steps to follow up initial solicitation with:
    - a. Email to all prospective DBE firms in relevant work areas
    - b. Phone call log to DBE firms who express interest via written response or call
    - c. Fax/letter confirmation
    - d. Signed copy of record of subcontractor outreach effort

**b. Guidance for Evaluating DBE quotes**

- (1) Quote evaluation practices required to evaluate DBE quotes:
  - i. Reasonable Price: Contractors are expected to assess reasonable price by analyzing the contract scope for DBE subcontract feasibility and comparing common line items in DBE and non-DBE subcontract quotes for the same work. Per federal regulation, reasonable price is not necessarily the lowest price. See 49 CFR Part 26, Appendix A. IV.D(2).
- (2) Documentation submitted by the prime of the following evaluation is required to evaluate DBE quotes by contractors:



- i. Evaluation of DBE firm's ability to perform "possible items to subcontract" using legitimate reasons, including but not limited to, **a discussion** between the prime and DBE firm regarding its capabilities prior to the bid letting. If lack of capacity is the reason for not utilizing the DBE firm's quote, the prime is required to contact the DBE by phone and email regarding their ability to perform the work indicated in the UCP directory listed as their work area by NAICS code. Only the work area indicated by the NAICS code(s) listed in the UCP directory can be counted toward DBE credit. Documentation of the conversation is required.
  - a In striving to meet an assigned DBE contract goal, contractors are expected to use DBE quotes that are responsive and reasonable. This includes DBE quotes that are not the low quote.
  - b Additional evaluation - Evaluation of DBE quotes with tied bid items. Typically, this type of quoting represents a cost saving but is not clearly stated as a discount. Tied quotes are usually presented as an 'all or none' quote. When non-DBE subcontractors submit tied bid items in their quotes, the DBE firm's quote may not appear competitive. In such a case, the following steps are taken in comparing the relevant quotes. These are qualitative examples:
    - i Compare bid items common to both quotes, noting the reasonableness in the price comparison.
    - ii Review quotes from other firms for the bid items not quoted by the DBE firm to see if combining both can provide the same competitive advantage that the tied bid items offered.

See Appendix D – *Good Faith Effort Evaluation Measures* and Appendix E - *Good Faith Effort Best Practices*.

- c. **Requesting Good Faith Effort Evaluation** At the time of bid- if the DBE goal is not met in full, the prime contractor must indicate they will file form DT1202- Documentation of Good Faith Effort within 24-hours of bid submission. Supplementary documentation of good faith effort that supports the DT1202 submission is also due within 24-hours of bid submission and prior to bid posting. Supporting documentation for the DT1202 is to include the following:
  - (1) Solicitation Documentation: The names, addresses, email addresses, and telephone numbers of DBE firms contacted along with the dates of both initial and follow-up contact; electronic copies of all written solicitations to DBE firms. A printed copy of SBN solicitation is acceptable.
  - (2) Selected Work Items Documentation: Identify economically feasible work units to be performed by DBEs to include activities such as: list of work items to be performed; breaking up of large work items into smaller tasks or quantities; flexible time frames for performance and delivery schedules.
  - (3) Documentation of Project Information provided to interested DBEs: A description of information provided to the DBE firms regarding the plans, specifications, and estimated quantities for portions of the work to be performed by that DBE firm.
  - (4) Documentation of Negotiation with Interested DBEs: Provide sufficient evidence to demonstrate that good faith negotiations took place. Merely sending out solicitations requesting bids from DBEs does not constitute sufficient good faith efforts.
  - (5) Documentation of Sound Reasoning for Rejecting DBEs and copies of each quote received from a DBE firm and, if rejected, copies of quotes from non-DBEs for same items.
  - (6) Documentation of Assistance to Interested DBEs- Bonding, Credit, Insurance, Equipment, Supplies/Materials
  - (7) Documentation of outreach to Minority, Women, and Community Organizations and other DBE Business Development Support: Contact organizations and agencies for assistance in contacting, recruiting, and providing support to DBE subcontractors, suppliers, manufacturers, and truckers at least 14 days before bid opening. Participate in or host activities such as networking events, mentor-protégé programs, small business development workshops, and others consistent with DBE support.

If the Good Faith Effort documentation is deemed adequate, the request will be approved and the DBE office will promptly notify the Prime Contractor and Bureau of Project Development.

If the DBE Office denies the request, the Prime Contractor will receive written correspondence outlining the reasons. The Department encourages the Prime Contractor to communicate with DBE staff to clarify any questions related to meeting goals and/or contractor demonstration of good faith efforts.

If the contract is awarded, the Prime Contractor must obtain written consent from the DBE Office to change or replace any DBE firm listed on the approved DBE Commitment. No contractor, prime or subsequent tier, shall be paid for completing work assigned to a DBE subcontractor on an approved DBE Commitment unless WisDOT has granted permission for the reduction, replacement, or termination of the assigned DBE in writing. If a prime contractor or a subcontractor on any tier uses its own forces to perform work assigned to a DBE on an approved DBE Commitment, **they will not be paid for the work**. Any changes to DBE Commitment after the approval of the DBE Commitment must be reviewed and approved by the DBE Office prior to the change (see Section 9).

Additional resources for demonstrating and tracking good faith effort can be found on the “Contracting with a DBE” webpage in the [ASP-3 and Good Faith Effort Guidance](#) section.

#### 4. Bidder's Documentation of Good Faith Effort Evaluation Request Appeal Process

A bidder can appeal the Department's decision to deny the bidder's demonstration of Good Faith Effort through Administrative Reconsideration. The bidder must provide a written justification refuting the specific reasons for denial as stated in the Department's denial notice. The bidder may meet in person with the Department if so requested. Failure to appeal within 5 business days after receiving the Department's written notice denying the request constitutes a forfeiture of the bidder's right of appeal. Receipt of appeal is confirmed by email date stamp or certified mail signed by WisDOT staff. A contract will not be executed without documentation that the DBE provisions have been fulfilled.

The Department will appoint a representative who did not participate in the original good faith effort determination, to assess the bidder's appeal. The Department will issue a written decision within 5 business days after the bidder presents all written and oral information. In that written decision, the Department will explain the basis for finding that the bidder did or did not demonstrate an adequate good faith effort to meet the contract DBE goal. The Department's decision is final.

#### 5. Determining DBE Eligibility

##### Directory of DBE firms

- a. The only resource for DBE firms certified in the State of Wisconsin is the Wisconsin Unified Certification Program (UCP) DBE Directory. WisDOT maintains a current list of certified DBE firms at: <http://wisconsindot.gov/Documents/doing-bus/civil-rights/dbe/dbe-ucp-directory.xlsx>
- b. The DBE Program office is available to assist with contracting DBE firms:(608) 267-3849.
- c. DBE firms are certified based on various factors including the federal standards from the Small Business Administration that assigns a North American Industrial Classification (NAICS) Codes. DBE firms are only eligible for credit when performing work in their assigned NAICS code(s). If a DBE subcontractor performs work that is not with its assigned NAICS code, the prime contractor should contact the DBE Office to inquire about compatibility with the Business Development Program.

## 6. Counting DBE Participation

### Assessing DBE Work

The Department will only count the DBE usage towards the contract DBE goal if the DBE firm is certified as a DBE by one of the UCP agencies. The Department only counts the value of the work a DBE actually performs towards the DBE goal. The Department assesses the DBE work as follows:

- a. The Department counts work performed by the DBE firm's own resources. The Department includes the cost of materials and supplies the DBE firm obtains for the work. The Department also includes the cost of equipment the DBE firm leases for the work. The Department will not include the cost of materials, supplies, or equipment the DBE firm purchases or leases from the prime contractor or its affiliate, with the exception of non-project specific leases the DBE has in place before the work is advertised.
- b. The Department counts fees and commissions the DBE subcontractor charges for providing bona fide professional, technical, consultant, or managerial services. The Department also counts fees and commissions the DBE charges for providing bonds or insurance. The Department will only count costs the program engineer deems reasonable based on experience or prevailing market rates.
- c. If a DBE firm subcontracts work, the Department counts the value of the work subcontracted to a DBE subcontractor.
- d. The contractor will maintain records and may be required to furnish periodic reports documenting its performance under this item.
- e. It is the Prime Contractor's responsibility to determine whether the work that is committed and/or contracted to a DBE firm can be counted for DBE credit by referencing the work type and NAICS code listed for the DBE firm on the Wisconsin UCP DBE Directory.
- f. It is the Prime Contractor's responsibility to assess the DBE firm's ability to perform the work for which it is committing/contracting the DBE to do. Note that the Department encourages the Prime Contractor to assist and develop DBE firms to become fully knowledgeable contractors to successfully perform on its contracts.
- g. The Prime Contractor will inform the DBE office via email of all DBE subcontractors added to the project following execution of the contract. The Prime Contractor may omit submission of another form DT1506, but must submit signed Attachment A forms for additional DBE firms.
- h. See Section 7 for DBE credit evaluation for Trucking and Section 8 for DBE credit evaluation for Manufacturers, Suppliers, and Brokers

Naming conventions: When emailing files, please use the following language to identify your submission-  
 "Project #, Proposal #, Let date, Business Name, Attachment A"      Email: [DBE\\_Alert@dot.wi.gov](mailto:DBE_Alert@dot.wi.gov)

\*Note: A sublet request is required for DBE work, regardless of subcontract tier, and also for reporting materials or supplies furnished by a DBE.

- Sublet Requests via form DT1925 or WS1925 are required for 1st Tier DBEs
- For all 2nd Tier and below notification of DBE sublet is indicated by the contractor entering them in CRCS

## 7. Credit Evaluation for Trucking

All bidders are expected to adhere to the Department's current trucking policy posted on the HCCI website at: <http://wisconsindot.gov/Documents/doing-bus/civil-rights/dbe/trucking-utilization-policy.pdf>

The prime contractor is responsible for ensuring that all subcontractors including trucking firms, receive Form FHWA 1273: <https://www.fhwa.dot.gov/programadmin/contracts/1273/1273.pdf>

See Section 8 for Broker credit.

## 8. Credit Evaluation for Manufacturers, Suppliers, Brokers

The Department will calculate the amount of DBE credit awarded to a prime using a DBE firm for the provisions of materials and supplies on a contract-by-contract basis. The Department will count the material and supplies that a DBE firm provides under the contract for DBE credit based on whether the DBE firm is a manufacturer, supplier, or broker. Generally, DBE credit is determined through evaluation of the DBE owner's role, responsibility, and contribution to the transaction. Maximum DBE credit is awarded when the DBE firm manufactures materials or supplies. DBE credit decreases when the DBE firm solely supplies materials, and minimal credit is allotted when the DBE firm's role is administrative or transactional. It is the bidder's responsibility to confirm that the DBE firm is considered a supplier or a manufacturer before listing them on Commitment to Subcontract to DBE form DT1506 or DBE Commitment submitted with the bid.

### a. Manufacturers

- (1) A manufacturer is a firm that operates or maintains a factory or establishment that produces, on the premises, the materials, supplies, articles, or equipment required under the contract and of the general character described by the specifications.
- (2) If the materials or supplies are obtained from a DBE manufacturer, **100%** percent of the cost of the materials or supplies counts toward DBE goals.

### b. Regular Dealers of Material and/or Supplies

- (1) A regular dealer is a firm that owns, operates, or maintains a store, warehouse, or other establishment in which the materials, supplies, articles or equipment of the general character described by the specifications and required under the contract are bought, kept in stock, and regularly sold or leased to the public in the usual course of business.
- (2) If the materials or supplies are purchased from a DBE regular dealer, count **60%** percent of the cost of the materials or supplies toward DBE goals.
- (3) At a minimum, a regular dealer must meet the following criteria to be counted for DBE credit:
  - i. The DBE firm must be an established, regular business that engages, as its principal business and under its own name, in the purchase and sale or lease of the products in question.
  - ii. The DBE firm must both own and operate distribution equipment for the product--bulk items such as petroleum products, steel, cement, gravel, stone, or asphalt. If some of the distribution equipment is leased, the lease agreement must accompany the DBE Commitment form for evaluation of the dealer's control before the DBE office approves the DBE credit.
- (4) When DBE suppliers are contracted, additional documentation must accompany the DBE Commitment and Attachment A forms. An invoice or bill-of-sale that includes names of the bidder and the DBE supplier, along with documentation of the calculations used as the basis for the purchase agreement, subcontract, or invoice. WisDOT recognizes that the amount on the Attachment A form may be more or less than the amount on the invoice per b.(1) above.
  - i. The bidder should respond to the following questions and include with submission of form DT1506 or the DBE Commitment entered with bid:
    - a. What is the product or material?
    - b. Is this item in the prime's inventory or was the item purchased when contract was awarded?

- c. Which contract line items were referenced to develop this quote?
- d. What is the amount of material or product used on the project?
- (5) Supplies purchased in **bulk** from DBE firms at the beginning of the season may be credited to current contracts if submitted with appropriate documentation to the DBE office.
  - i. To ensure that the appropriate credit is assigned, follow the procedure below:
    - a. When DBE suppliers are contracted for bulk supply or commodity purchases, an invoice or bill-of-sale that includes names of the contractor and the DBE supplier should be submitted to the DBE Office via eSubmit (preferred during letting) or the DBE\_Alert email box. The supply/commodity credit may be applied during the federal fiscal year (October- September) in which the purchase was made.
    - b. When the contractor intends to apply the credit to a particular project, submit a copy of the original invoice, documentation of the calculations for supplies/commodities to be used on the project, and an Attachment A. Indicate on the Attachment A:
      - c. This supply/commodity is in the prime's inventory or pre-paid in case of commodities
      - d. The full value of the original invoice submitted to the DBE Office, above in (1)
      - e. The amount of material or product used on this project
      - f. Fuel estimate listed on Attachment A will be recorded as a deduction from the full fuel purchase amount shown on the invoice
  - ii. DBE Office Process (Applies only to bulk purchases)
    - a. Supply/Commodity commitment is received
    - b. Engineer verifies amount listed on invoice and enters the full amount into spreadsheet
    - c. The amount of credit applied for each project is updated on the spreadsheet until the bulk purchase is exhausted
    - d. Engineer informs contractor when full amount of bulk purchase has been applied

**c. Brokers, Transaction Expeditors, Packagers, Manufacturers' Representatives**

- (1) No portion of the cost of the materials, supplies, services themselves will count for DBE credit. However, WisDOT will evaluate the fees or commissions charged when a prime purchases materials, supplies, or services from a DBE certified firm which is neither a manufacturer nor a regular dealer, namely: brokers, packagers, manufacturers' representatives, or other persons who arrange or expedite transactions.
- (2) Brokerage fees are calculated as **10%** of the purchase amount.
- (3) WisDOT may count the amount of fees or commissions charged for assistance in the procurement of the materials and supplies, fees, or transportation charges for the delivery of materials or supplies required on a job site.
- (4) Evaluation of DBE credit includes review of the contract need for the item/service, the sub-contract or invoice for the item/service, and a comparison of the fees customarily allowed for similar services to determine whether they are reasonable.

**9. DBE Commitment Modification Policy (Formerly "DBE Replacement Policy")**

**a. Issuing a Contract Change Order**

Any changes or modifications to the contract once executed are considered contract modifications and as such require a change order. In addition, the DBE office must provide consent for reduction, termination, or replacement of subcontractors approved on the DBE Commitment *in advance* of the modification for the prime contractor to receive payment for work or supplies. Additions to the DBE Commitment do not require advance notification of the DBE office. (see below e. DBE Utilization beyond the approved DBE Commitment)

**b. Contractor Considerations**

- (1) A prime contractor cannot modify the DBE Commitment through reduction in participation, termination, or replacement of a DBE subcontractor listed on the approved DBE Commitment without prior written consent from the DBE Office. This includes, but is not limited to, instances in which a prime contractor

seeks to perform work originally designated for a DBE subcontractor with its own forces or those of an affiliate, a non-DBE firm, or with another DBE firm.

- (2) If a prime contractor reduces participation, replaces, or terminates a DBE subcontractor who has been approved for DBE credit toward its contract, the prime is required to provide documentation supporting its inability to fulfill the contractual commitment made to the Department regarding the DBE utilization.
- (3) The Prime Contractor is required to demonstrate efforts to find another DBE subcontractor to perform at least the same amount of work under the contract as the DBE subcontractor that was terminated, to the extent needed to meet the assigned DBE contract goal. When additional opportunity is available by contract modifications, the Prime Contractor must utilize DBE subcontractors that were committed to equal work items, in the original contract.
- (4) In circumstances when a DBE subcontractor fails to complete its work on the contract for any reason, or is terminated from a contract, the Prime Contractor must undertake efforts to maintain its commitment to the assigned DBE goal.
- (5) The DBE subcontractor should communicate with the Prime Contractor regarding its schedule and capacity in the context of the contract. If the DBE firm anticipates that it cannot fulfill its subcontract, they will advise the Prime Contractor and suggest a DBE subcontractor that may replace their services and provide written consent to be released from its subcontract.
  - i. Before the Prime Contractor can request modification to the approved DBE Commitment, the Prime Contractor must:
    - a. Make every effort to fulfill the DBE Commitment by working with the listed DBE subcontractor to ensure that the firm is fully knowledgeable of the Prime Contractor's expectations for successful performance on the contract. Document these efforts in writing.
    - b. If those efforts fail, provide written notice to the DBE subcontractor of the Prime Contractor's intent to request to modify the Commitment through reduction in participation, termination, and/or replacement of the subcontractor including the reason(s) for pursuing this action.
    - c. Copy the DBE Office on all correspondence related to changing a DBE subcontractor who has been approved for DBE credit on a contract, including preparation and coordination efforts.
    - d. Clearly state the amount of time the DBE firm has to remedy and/or respond to the notice of intent to replace/terminate. The DBE must be allowed five days from the date notice was received as indicated by email time stamp or signed certified mail, to respond, in writing. EXCEPTION: The Prime Contractor must provide a verifiable reason for a response period shorter than five days. For example, a WisDOT project engineer or project manager confirms that WisDOT has eliminated an item the DBE subcontractor was contracted for.
    - e. The DBE subcontractor must acknowledge the contract modification with written response to the Prime Contractor and the DBE Office. If objecting to the subcontract modification, the DBE subcontractor must outline the basis for objection to the proposed modification, providing sound reasoning for WisDOT to reject the prime's request.

### **c. Request to Modify DBE Subcontracting Commitment**

The written request referenced above may be delivered by email or fax. The request must contain the following:

1. Project ID number
2. WisDOT Contract Project Engineer's name and contact information
3. DBE subcontractor name and work type and/or NAICS code
4. Contract's progress schedule
5. Reason(s) for requesting that the DBE subcontractor be replaced or terminated
6. Attach/include all communication with the DBE subcontractor to deploy/address/resolve work completion

Naming conventions: When emailing files, please use the following language to identify your submission- "Project #, Proposal #, Let date, Business Name, MODIFICATION" Email: [DBE\\_Alert@dot.wi.gov](mailto:DBE_Alert@dot.wi.gov) + Project Engineer

WisDOT will review the request and any supporting documentation submitted to evaluate if the circumstance and the reasons constitute good cause for replacing or terminating the approved DBE subcontractor.

*Good Causes to Replace a DBE subcontractor according to the federal DBE program guidelines {49 CFR part 26.53}*

- The listed DBE subcontractor fails or refuses to execute a written contract
- The listed DBE subcontractor fails or refuses to perform the work of its subcontract in a way consistent with normal industry standards. Provided, however, that good cause does not exist if the failure or refusal of the DBE subcontractor to perform its work on the subcontract results from the bad faith or discriminatory action of the prime contractor
- The listed DBE subcontractor fails or refuses to meet the prime contractor's reasonable, nondiscriminatory bond requirements
- The listed DBE subcontractor becomes bankrupt, insolvent, or exhibits credit unworthiness
- The listed DBE subcontractor is ineligible to work on public works projects because of suspension and debarment proceedings pursuant 2 CFR Parts 180, 215, and 1,200 or applicable state law
- The prime has determined that the listed DBE subcontractor is not a responsible contractor
- The listed DBE subcontractor voluntarily withdraws from the project and provides written notice of its withdrawal
- The listed DBE subcontractor is ineligible to receive DBE credit for the type of work required
- A DBE firm owner dies or becomes disabled with the result that the listed DBE subcontractor is unable to complete its work on the contract.

**d. Evaluation and Response to the Request**

WisDOT's timely response to the Prime Contractor's request for modification of the approved DBE Commitment will be provided to the prime and the WisDOT project engineer via email.

If WisDOT determines that the Prime Contractor's basis for reduction in participation, replacement, or termination of the DBE subcontractor is not consistent with the good cause guidelines, the DBE office will provide a response via email within 48-hours of receipt of request from the Prime Contractor as indicated by email time stamp. The communication will include: the requirement to utilize the committed DBE, actions to support the completion of the contractual commitment, a list of available WisDOT support services, and administrative remedies, including withholding payment to the prime, that may be invoked for failure to comply with federal DBE guidelines for DBE replacement.

The WisDOT contact for all actions related to modification of the approved DBE Commitment is the DBE Program Engineer who can be reached at [DBE\\_Alert@dot.wi.gov](mailto:DBE_Alert@dot.wi.gov) or (414) 335-0413.

**e. DBE Utilization beyond the approved DBE Commitment**

When the prime or a subcontractor increases the scope of work for an approved DBE subcontractor or adds a DBE subcontractor who was not on the approved form DT1506 or DBE Commitment submitted with bid at any time after contract execution, this is referred to as voluntary DBE contract goal achievement. The contractor must follow these steps to ensure that the participation is accurately credited toward the DBE goal:

- (1) Forward a complete, signed Attachment A form to the DBE Office. A complete Attachment A includes DBE subcontractor contact information, signatures, subcontract value, and description of the work areas to be performed by the DBE. The DBE Office will verify the DBE participation and revise the DBE Commitment based on the email/discussion and the new Attachment A.
- (2) When adding to an existing DBE Commitment, submit a new Attachment A to the DBE Alert mailbox
- (3) OR Submit a final Attachment A to DBE Alert during the Finals Process when Compliance receives notice of "Substantially Complete"



Naming conventions: When emailing files, please use the following language to identify your submission- "Project #, Proposal #, Let date, Business Name, New Attachment A" Email: DBE\_Alert@dot.wi.gov

### Special note on trucking

- DBE truckers added to the sublets in CRCS *will* be approved without DBE credit (You will see a "N" in CRCS instead of "Y")
- Prime Contractors may enter a "place holder" e.g. \$1000.00, for DBE Trucking in CRCS if the full amount of trucking is unknown for sublet purposes only
- The hiring contractor may obtain the Attachment A with DBE signature included but the **Prime Contractor** must sign the Attachment A before submitting
- DBE truckers need to be added to the DBE commitment once. If the DBE trucker is on the initial commitment (DT1506/E1506) there is no requirement to submit another Attachment A for that trucker for that contract.

## 10. Commercially Useful Function

- a. Commercially Useful Function (CUF) is evaluated after the contract has been executed, while the DBE certified firm is performing contracted work items.
- b. The Department uses Form DT1011, DBE Commercially Useful Function Review and Certification to evaluate if the DBE is performing a commercially useful function. WisDOT counts expenditures of a DBE toward the DBE goal only if the DBE is performing a commercially useful function on that contract.
- c. A DBE firm is performing a commercially useful function if the following conditions are met:
  - (1) For contract work, the DBE is responsible for executing a distinct portion of the work and is carrying out its responsibilities by actually performing, managing, and supervising that work.
  - (2) For materials and supplies, the DBE is responsible for negotiating price, determining quality and quantity, ordering, and paying for those materials and supplies.
- d. Offsite Hauling – when DBE truck will haul between a pit and plant or location other than the construction site associated with the commitment
  - (1) Indicate Offsite Hauling on Attachment A
  - (2) Discuss offsite hauling at weekly progress meetings with Project Engineer (PE)
  - (3) PE conducts spot checks of pits/plants to verify DBE truck is hauling and/or verifying hauling log
  - (4) Prime should be prepared to submit haul tickets, plant/pit tickets, timecards, and other pertinent documentation if requested by PE or DBE Office

## 11. Credit Evaluation for DBE Primes

WisDOT calculates DBE credit based on the amount and type of work performed by DBE certified firms for work submitted with required documentation. If the prime contractor is a DBE certified firm, the Department will only count the work that the DBE prime performs with its own forces for DBE neutral credit. The Department will also calculate DBE credit for work performed by any other DBE certified subcontractor, DBE certified supplier, and DBE certified manufacturer on the contract in each firm's approved NAICS code/work areas that are submitted with required documentation. Crediting for manufacturers and suppliers is calculated consistent with Section 8 of this document and 49 CFR Part 26.



## 12. Joint Venture

A joint venture is an association of a DBE firm and one or more other firms to carry out a single, for-profit business enterprise, for which the parties combine their property, capital, efforts, skills and knowledge, and in which the DBE is responsible for a distinct, clearly defined portion of the work of the contract and whose share in the capital contribution, control, management, risks, and profits of the joint venture are commensurate with its ownership interest. If a DBE performs as a participant in a joint venture, the Department will only credit the portion of the total dollar value of the contract equal to the portion of the work that the DBE performs with its own forces.

## 13. Mentor-Protégé

- a. If a DBE performs as a participant in a mentor-protégé agreement, the Department will credit the portion of the work performed by the DBE protégé firm.
- b. DBE credit is evaluated and confirmed by the DBE Office for any contracts on which the mentor-protégé team identifies itself to the DBE Office as a current participant of the Mentor-Protégé Program.
  - (1) DBE credit may only be awarded to a non-DBE mentor firm for using its own protégé firm for less than one half of its goal on any contract; and
  - (2) Not award DBE credit to a non-DBE mentor firm for using its own protégé firm for more than every other contract performed by the protégé firm.
- c. A DBE protégé firm may be eligible for conditional NAICS code extension for training with the mentor. Request permission from the DBE Office- Certification area.
- d. Refer to WisDOT's Mentor-Protégé guidelines for guidance on the number of contracts and amount of DBE credit allowed on WisDOT projects.

## 14. Use of Joint Checks

The use of joint checks is allowable if it is a commonly recognized business practice in the material industry. A joint check is defined as a two-party check between a DBE subcontractor, a prime contractor, and the regular dealer or materials supplier who is neither the prime nor an affiliate of the prime. Typically, the prime contractor issues one check as payor to the DBE subcontractor and to the supplier jointly (to guarantee payment to the supplier) as payment for the material/supplies used by the DBE firm in cases where the DBE subcontractor and materials have been approved for DBE credit. The DBE subcontractor gains the opportunity to establish a direct contracting relationship with the supplier to potentially facilitate a business rapport that results in a line of credit or increased partnering opportunities.

The cost of material and supplies purchased by the DBE firm is part of the value of work performed by the DBE to be counted toward the goal. To receive credit, the DBE firm must be responsible for negotiating price, determining quality and quantity, ordering the materials, and installing (where applicable) and "paying for the material itself." See 49 CFR 26.55(c)(1).

The approval to use joint checks constitutes a commitment to provide further information to WisDOT, upon request by staff. WisDOT will allow the use of joint checks when the following conditions are met:

- a. The Prime Contractor must request permission to use joint checks from the DBE Office by submitting the Application to Use Joint Checks.
  - (1) Request should be made when the DBE Commitment or the Request to Sublet is submitted; the request will not be considered if submitted after the DBE Subcontractor starts its work.
  - (2) Approval/Permission must be granted prior to the issuance of any joint checks.

- (3) The payment schedule for the supplier must be presented to the DBE office before the first check is issued.
  - (4) The joint check for supplies must be strictly for the cost of approved supplies.
- b. The DBE subcontractor is responsible for furnishing and/or installing the material/work item and is not an 'extra participant' in the transaction. The DBE firm's role in the transaction cannot be limited solely to signing the check(s) to release payment to the material supplier. At a minimum, the DBE subcontractor's tasks should include the following:
- (1) The DBE subcontractor (not the prime/payor) negotiates the quantities, price, and delivery of materials.
  - (2) The DBE subcontractor consents to sign/release the check to the supplier by signing the [Application to Use Joint Checks](#) after establishing the conditions and documentation of payment within the subcontract terms or in a separate written document.
- c. The Prime contractor/payor acts solely as a guarantor.
- (1) The Prime Contractor agrees to furnish the check used for the payment of materials/supplies under the contract.
  - (2) The prime contractor/payor cannot require the subcontractor to use a specific supplier or the prime contractor's negotiated unit price.

## 15. Payment

Costs for conforming to this Additional Special Provision (ASP) and any associated DBE requirements are incidental to the contract.

## Appendix A

### Substantive Conversation Guidelines

The substantive conversation is critical to all bidders' demonstration of good faith effort to meet the DBE goal prior to bid opening. Relationship building between primes and subcontractors is crucial to DBE goal attainment. Responsible bidders seek to build rapport with potential DBE subcontractors to understand capacity, areas of expertise, and assess contracting feasibility. Bidders who compete for WisDOT contracts are specialty contractors responding to a growing and changing contract environment. Just as these specialists are responsible for care of the roads, they are likewise responsible for contributing to the health of the industry. The substantive conversation drives collaboration that will build industry health and capacity. The following is intended to provide guidance for such discussions but is not an exhaustive list. Contractors are encouraged to incorporate their existing strategies for cultivating business relationships as well.

Prior to Bid Opening- this discussion should happen as early as possible (WisDOT advertisements are released 5 weeks prior to each Let)

- Determine DBE subcontractor's interest in quoting
- If response indicates inexperience with quoting- offer support/assistance to the DBE in understanding the industry including fundamentals a subcontractor needs to know, required reading and/or resources.
- Assess their interest and experience in the road construction industry by asking questions such as:
  1. Have you competed for other WisDOT contracts? Ratio of competed/to wins
  2. Have you performed on any transportation industry contracts (locally or with other states)?
  3. What the largest contract you've completed?
  4. Have you worked in the industry: apprentice, journeyman, safety, inspection etc.?
  5. Does this project fit into your schedule? Are you working on any contracts now?
  6. Have you reviewed a copy of the plans? Are you comfortable performing within the scope and quantity considerations of this contract?
  7. What region do you work in? Home base?
  8. Which line items are you considering?
  9. Have you read/are you familiar with WisDOT Standard Specifications? Construction Material Manual?
  10. Do you understand where your work fits in the project schedule, project phases?

Following Bid Opening- this discussion can happen at any time

1. After reviewing their quote, note the following in your discussion:
  - Does the quote look complete? Irregular?
  - Are there errors in the quote? Are items very high or very low?
  - In general, does the quote look competitive?
2. Questions and Advice for the bidder to share with the potential DBE subcontractor:
  - What line items would typically be in a competitive quote for a subcontractor of their specialty?
  - How many employees and what is their role/experience/expertise in your firm?
  - Do you have resources for labor (union member, family-based, community-resourced) and capital (banking relationship, bond agent, CPA)?
  - Where have you worked: cities, states, government, commercial, residential/private sector, etc. Explain similarities or differences.
  - Refer them to reliable, trusted, industry resources that can educate or connect them to relevant resources, education/certification resources, more appropriate contract opportunities.
  - Discussion about prime contract and subcontract liability, critical path items, contract quantities, schedule risks, and potential profit/loss (for upcoming known projects or in general).
  - Discussion of bonding, insurance, and overall business risk considerations.

## APPENDIX B

## Sample Contractor Solicitation Letter Page 1

*(This sample is provided as a guide, not a formatting requirement)*

### DBE Solicitation - [Month] [Day], [Year] WisDOT Bid Letting

Attention all DBEs. [Prime Contractor] is actively seeking your quote for the [Month][Day], [Year] Bid Letting. [Prime Contractor] is considering bidding on the projects listed on page 2 as a prime contractor. Please see page 2 for instructions and the sub-contractable opportunities for each proposal.

**Does [Prime Contractor] accept quotes in areas we might self-perform?** Yes, we do! We support this federal rule and (if needed) we consider areas we might self-perform an opportunity to provide in the field assistance and training if we award your quote.

**Where can DBEs find the plans, specifications & addenda?** Please visit [Prime Contractor's] plan room [LINK] or on WisDOT's Highway Construction Contract Information HCCI website: [Wisconsin Department of Transportation Highway Construction Contract Information \(wisconsindot.gov\)](http://WisconsinDepartmentofTransportationHighwayConstructionContractInformation(wisconsindot.gov)). This same website can be checked for the contract status.

**What should your quote include?** All the costs required to complete the items you propose to perform including labor, equipment, material, and related bonding or insurance. The quote should also note items that you are DBE certified to perform, tied items, and any special terms. Please use page 2 as your cover sheet for your quote.

**Do you have a question regarding bonding, credit, insurance, equipment, or supplies/materials?** We welcome all DBE questions! Please call [Prime Contractor] and ask to speak with [Contact]. [Prime Contractor] can provide basic information as well as a referral to a trusted industry partner for insurance and bonding needs.

#### **When are quotes due?**

**[Month] [Day], [Year] at [Time].** We accept quotes via SBN, email, or fax. Please make every effort to have your quotes in by this time or earlier. Quality check your quote so it includes the correct letting date, project ID, proposal number, unit price and extension.

**Who can DBEs contact for questions, information, clarification or for a quote evaluation?** [Project Manager Name] [Phone] [Email]. If you are quoting [Prime Contractor] for the first time, we encourage you to come meet with us in person to discuss the project. Our office hours are 7:30 a.m. – 5:00 p.m. On bid day, we are in the office by 6:30 a.m.

#### **Why partner with [Prime Contractor]?**

DBE partnership is a core part of [Prime Contractor's] mission. Including DBEs at the beginning of each project is essential in the success of each project. We consider DBEs to be important industry partners who bring dedication and knowledge at various stages during construction. We are proud to be an industry leader with our DBE partnership. Your success as a DBE is our success.

**Sample Contractor Solicitation Letter Page 2**  
*(This sample is provided as a guide, not a formatting requirement)*  
 REQUEST FOR QUOTE

**[Prime Contractor]**  
**Letting Date: [Month] [Day], [Year]**  
**Project IDs: 1234-56-00 (Proposal #1) & 1234-01-78 (Proposal #6)**

Please check all that apply:

- Yes, we will be quoting the projects & items listed below
- No, we are not interested in quoting on the letting or its items referenced below
- Please take our name off your monthly DBE contact list
- We have questions about quoting this letting. Please have someone contact me at this number:

Prime Contractor Contact: \_\_\_\_\_ DBE: \_\_\_\_\_  
 Phone: \_\_\_\_\_ Fax: \_\_\_\_\_  
 Email: \_\_\_\_\_

**Please circle the proposals and items you will be quoting below and contact us with any questions**

Proposal County	1 Dane County	6 Crawford County
Clearing & Grubbing	X	X
Dump Truck Hauling	X	X
Curb/Gutter/Sidewalk	X	
Erosion Control Items		X
Excavation	X	X
Pavement Marking		X
Traffic Control	X	
Sawing	X	X
QMP, Base		X
Pipe Underdrain	X	
Landscape		X
Beam Guard	X	
Electrical	X	
Signs/Posts/Markers		X
Survey/Staking		X

Again, please make every effort to have your quotes into our office by time deadline prior to the letting date.

**Sample Contractor Solicitation Email - Simplified**  
*(This sample is provided as a guide, not a formatting requirement)*

**ATTENTION DBEs**

- **[Prime Contractor] specializes in municipal projects in the XX Region(s)**
- **We have successfully competed for and completed XX WisDOT projects over the past XX years**
- **Consider [Prime Contractor] your partner on WisDOT Projects**

**[Prime Contractor] is seeking your subcontractor quote for the XX/XX/20XX WisDOT bid letting on the below projects:**

Project	Proposal	County	Region
1234-56-00	2	Dane	SW
1234-01-78	6	Crawford	SW

- Please review the attachments [**attach Solicitation Letter**] and respond with your intent to quote (or not) along with the work items you are interested in performing and respond via fax or email by **date**. The quote should note items that you are DBE certified to perform, tied items, and any special terms. Please include labor, equipment, material, and related bonding or insurance.
- If you have any questions regarding bonding, credit, insurance, equipment and/or materials/supplies, please feel free to call [Prime Contractor] and ask for [Contact]. **(Include if your company is willing to answer these types of DBE questions)**
- Plans and Specifications can be found: **WisDOT HCCI Website: List webpage where plans are located**
- If you do choose to quote, please make every effort to have your quote into our office by **time and date**. Make sure the correct letting date, project number, unit price and extension are included in your quote.
- Should you have questions regarding the mentioned project, please call our office at (414) 555-5555 and we will direct you to the correct estimator/project manager. Our office hours are 7:30 a.m. - 5:00 p.m.

**Thank you – we look forward to working with your company on this project!**

**Prime Contractor**  
**Project Manager**  
 Direct: 414-555-5555  
 Cell: 414-555-5556

## Sample Contractor Solicitation Email to **non-DBE** WisDOT Subcontractors - Simplified

*(This sample is provided as a guide, not a formatting requirement)*

### ATTENTION WisDOT SUBCONTRACTORS

[Prime Contractor] is considering bidding on the below projects for the XX/XX/20XX WisDOT Bid Letting:

Project	Proposal	County	Region	DBE Goal
1234-56-00	2	Dodge	SW	6.00%
1234-01-78	11	Adams	NC	3.00%
1234-00-99	20	Buffalo	NW	5.00%
1234-00-98	33	Portage	NC	6.00%

The above projects have DBE goals and [Prime Contractor] is committed to DBE inclusion with every project. As such, we are requesting:

- All WisDOT Subcontractors to **solicit and utilize** DBEs in your quotes.
- DBE participation can be achieved through purchasing materials from DBE suppliers, using DBE subcontractors and/or DBE trucking firms or any combination of these.
- If there is an opportunity to untie an item in your quote so a DBE can be utilized, please look for those opportunities as well.
- Your quote will be evaluated based on the amount of DBE participation your company is able to provide when compared to other quotes for the same work.

If you do choose to quote, please make every effort to have your quote into our office by **time and date**. Please submit all quotes to [Email]. Make sure the correct letting date, project number, unit price and extension are included in your quote.

Should you have questions regarding the mentioned project, the Project Manager contact is: [Name]  
[Phone Number] [Email]

**Thank you for utilizing DBEs who are trusted industry partners with WisDOT projects.**

### Prime Contractor

Project Manager  
Direct: 414-555-5555  
Cell: 414-555-5556

## Appendix C

### Small Business Network (SBN) Overview

The Small Business Network is a part of the Bid Express® service that was created to ensure that prime bidders have a centralized online location to find subs - including small and disadvantaged business enterprises (DBEs). It is available for prime bidders to use as part of their Basic Service subscription. Within the Small Business Network, **Prime Contractors** can:

1. **Easily select proposals, work types and items:**
  - a. After adding applicable work types, select items that you wish to quote. Enter the sub-quote quantities and add comments, if desired. Adding or removing items and work types can be done quickly. If needed, you can save the sub-quote for later completion.
2. **Create sub-quotes for the subcontracting community:**
  - a. Create sub-quotes with ease using the intuitive sub-quote creator. In seven short steps, you can rapidly create a custom sub-quote directed to all subcontractors that bid on the applicable work types. Steps include: provide contact information and sub-quote expiration date, select letting and proposal, add work types and items, specify terms and conditions, upload attachments, and select vendors.
  - b. Create a sub-quote to send to subcontractors or suppliers that lists the items in a proposal that you want quoted
  - c. Create an unlimited number of sub-quotes for items you want quoted, and optionally mark them as a DBE preferred request.
  - d. Add attachments to sub-quotes.
3. **View sub-quote requests & responses:**
  - a. After logging into the Bid Express service, you can quickly review all of your sub-quote requests and all unsolicited sub-quote requests from subcontractors. To simplify the Small Business Network home screen, sub-quote requests can be hidden with one click if they are not applicable.
  - b. View or receive unsolicited sub-quotes that subcontractors have posted, complete with terms, conditions and pricing.
4. **View Record of Subcontractor Outreach Effort:**
  - a. For each sub-quote produced, a *Record of Subcontractor Outreach Effort* is generated that shows the response statistics for a particular sub-quote. If accepted by the letting agency, this report may serve as proof of a “Good Faith” effort in reaching out to the DBE community.
  - b. Easily locate pre-qualified and certified small and disadvantaged businesses.
  - c. Advertise to small and disadvantaged businesses more efficiently and cost effectively.
  - d. Document your interactions with subs/DBEs by producing an Outreach Report (may be accepted as proof of DBE outreach at the discretion of each agency).



The Small Business Network help small businesses learn more about opportunities, compete more effectively, network with other contractors and subcontractors, and win more jobs. The DBE will provide free SBN accounts to DBEs when requested. Use [DBE\\_Alert@dot.wi.gov](mailto:DBE_Alert@dot.wi.gov) to request an account. **DBE firms can:**

1. **View and reply to sub-quote requests from primes:**
  - a. After logging into the Bid Express service, you can quickly review all incoming sub-quote requests and all unsolicited sub-quotes created by your company. Receive notifications by selected work type. To simplify on the Small Business Network home screen, sub-quote requests can be filtered by work types relevant to your interests or hidden with one click if they are not applicable.
2. **Select items when responding to sub-quote requests from primes:**
  - a. You have the freedom to choose and price any number of items when responding to a sub-quote request. Quantities can be modified, and per-item comments are also available.
  - b. View requests for sub-quotes for work that primes have posted for projects they are bidding, add your pricing, terms, and conditions, and submit completed sub-quotes to the requesting primes.
  - c. Add attachments to a sub-quote.
3. **Create and send unsolicited sub-quotes to specific contractors:**
  - a. Create unsolicited sub-quotes with ease using the intuitive sub-quote creator. In eight short steps, you can rapidly create a custom sub-quote directed at any number of specific vendors of your choosing. Steps include: provide contact information and sub-quote expiration date, select letting and proposal, add work types and items, specify terms and conditions, upload attachments, and select vendors.
4. **Easily select and price items for unsolicited sub-quotes:**
  - a. After adding applicable work types, select items that you wish to quote. The extended price calculates automatically, cutting out costly calculation errors. Comments can be provided on a per-item basis as well.
  - b. Create an unsolicited sub-quote that lists the items from a proposal that you want to quote, include pricing, terms and conditions, and send it to selected prime/plan holder.
  - c. Add attachments to a sub-quote.
  - d. Add unsolicited work items to sub-quotes that you are responding to.
5. **Easy Access to Valuable Information**
  - a. Receive a confirmation that your sub-quote was opened by a prime.
  - b. View Bid Tab Analysis data from past bids, including the high, average and low prices of items.
  - c. View important notices and publications from DOT targeted to small and disadvantaged businesses.
6. **Accessing Small Business Network for WisDOT contracting opportunities**
  - a. If you are a contractor not yet subscribing to the Bid Express service, go to [www.bidx.com](http://www.bidx.com) and select "Order Bid Express." The Small Business Network is a part of the Bid Express Basic Service.

## APPENDIX D

### **Good Faith Effort Evaluation Measures *by categories referenced in DBE regulations***

Bidders must demonstrate that they took all necessary and reasonable steps to achieve the assigned DBE contract goal. For each contract, all bidders must submit documentation indicating the goal has been met or if falling short of meeting the assigned goal, must request a DBE Goal Waiver and document all efforts employed to secure DBE subcontractor participation on Form DT1202.

DBE staff analyze the bidder's documented good faith efforts to determine if action taken was sufficient to meet the goal. Sufficiency is measured contract-by-contract. WisDOT evaluates active and aggressive efforts, quality, quantity, scope, intensity, and appropriateness of the bidder's efforts as a scale of the principles of Good Faith outlined in 49 CFR Part 26, Appendix A. Additional emphasis is placed on the bidder's demonstration of timely submission of documentation and communication with DBE subcontractors, and business development initiatives undertaken to support DBE firm growth.

The following is a sample of good faith effort activities that are rated according to the accompanying rubric. Contractors are encouraged to identify additional activities that align with their business type(s).

- Personal, tailored solicitation to firms that specialize in work types planned or desired for subcontracting
- Follow up to initial solicitation via email or phone
- Substantive conversation including topics such as contract liability, critical path work items, schedule risks, and potential profit/loss
- SBN utilization including posting quotes
- Review and response to DBE quotes including provision of information about plans, specifications, and requirements as applicable
- Documentation requesting subcontractors support DBE goal by solicitation and inclusion of DBE subcontractor quotes
- Responsive and timely submission of organized documentation
- Analysis of number of DBE firms who do work types that you typically subcontract
- Analysis of number of DBE firms who reside in geographical areas where prime seeks work
- Analysis of firms who express interest in bidding/quoting including the number of firms who declined your solicitation
- Reference check of DBE subcontractor work or training (documentation of questions and response required)
- Number of different efforts undertaken to meet the assigned DBE goal as documented in accompanying Form DT1202
- Submission of all DBE quotes received matched with a variety of work to be performed by DBEs
- Number and names of DBE firms provided written advice, or referral to industry-specific business development resources
- Overall pattern of DBE utilization on all WisDOT contracts which may include contracting with municipalities
- Documentation of resources expended to meet assigned DBE goal (#of hours, staff titles, average pay rate, actions taken)
- Analysis of subcontractable work items to be completed by prime beyond prime contractor's 30%
- Risk analysis of work items that are typically in tied quotes that could be unbundled
- List of contract work items in smallest economically feasible units, identifying schedule impact
- Submission of a Gap Analysis identifying DBE skillset and/or industry needs
- Staff training in EEO and Civil Rights laws as documented in training logs
- Written Capacity Assessment completed with DBE firm documenting its ability to perform the work quoted
- DBE engagement efforts beyond simple solicitation that include a substantive discussion, initiated as early in the acquisition process as possible (*points added for each day prior to letting*)
- Outreach and marketing efforts with minority, women, and veteran-focused organizations at least 10 days prior to bid opening
- Active involvement in WisDOT's Business Development Program, TrANS training, facilitated networking efforts, workshops
- Customized teaching/training efforts for future opportunities with DBE subcontractor, contract specific and/or annually
- Introduction and reference provided for DBE subcontractor to a prime who has not previously contracted with the DBE firm
- Prime utilization of a DBE subcontractor the prime has not contracted with previously
- Written referral/recommendation to bond/insurance agents, manufacturer, supplier
- Documented efforts fostering DBE participation through administrative and/or technical assistance
- Evidence of negotiation with the DBE firm about current and future Let opportunities
- Recommendation of local and state services that support small business and access to opportunity: DOA, SBA, WEDC, WPI, etc.
- Advice on bonding, lines of credit, or insurance as required to complete the items quoted and contract requirements

## GFE EVALUATION RUBRIC – PHASE 1 – Initial Review

DT1202	Examples	Rating	OBOEC Feedback
<b>Solicitation Documentation</b>	<p>Identify all reasonable and available activities performed to solicit the interest of all certified DBEs who have capacity and ability to perform work on the project.</p> <p><i>Such as: Updated solicitation letter and email, timely solicitation, and follow-up, and/or utilized various methods to communicate solicitation (ex: letter, email, publication, posting and/or website)</i></p>		
<b>Selected Work Items Documentation</b>	<p>All work items are broken out into economically feasible units to facilitate DBE participation.</p> <p><i>Such as: Selected work items are <u>specific</u> to each proposal and clearly identified in all solicitation(s)</i></p>		
<b>Documentation of Project Information provided to Interested DBEs</b>	<p>Provide interested DBEs with adequate information about the plans, specifications, and any other contractual requirements in a timely manner to assist DBEs in response to solicitation.</p> <p><i>Such as: Project information is clearly identified in all solicitation(s)</i></p>		
<b>Documentation of Negotiation with Interested DBEs</b>	<p>Provide sufficient evidence demonstrating that good faith negotiations took place during the bid letting.</p> <p><i>Such as: Documented attempts with DBEs or on behalf of DBEs to increase DBE participation</i></p>		
<b>Documentation of Sound Reason for Rejecting DBEs</b>	<p>Provide sufficient evidence demonstrating that DBEs are rejected for sound reasons.</p> <p><i>Such as: Detailed and thoughtful analysis that considers both the percentage and dollar difference when rejecting a DBE including past performance, relevant business experience and stability, safety record, business ethic and integrity, technical capacity, and other tangible factors.</i></p>		
<b>Documentation of Assistance to Interested DBEs- bonding, credit, insurance, equipment, supplies/materials</b>	<p>Documented assistance in both solicitation(s) and outreach to DBEs.</p>		
<b>Documentation of Outreach to Minority, Women, and Community organizations and other DBE Business Development Support</b>	<p>Effectively use the services of minority, women, and community organizations as well as contractors' groups, local, state, and federal business assistance offices and organization that provide assistance in recruiting and supporting DBEs, as well participation in activities that support DBE business development.</p> <p><i>Such as: Variety of activities that translate into meaningful DBE participation</i></p>		
<b>Documentation of other GFE activities</b>	<p><i>Such as: Used DT1202 Excel Workbook, Diversity &amp; Inclusion company policy, Mentor-Protégé participant, awarded neutral DBE after bid submission, included company GFE overview/strategy information and/or company website highlights DBE opportunities and participation</i></p>		
<b>Overall Demonstration of GFE</b>			

**GFE EVALUATION RATING LEGEND – PHASE 1 – Initial Review**

Documentation provided by bidder is evaluated and rated on the rubric. Bidders should include activities characterized by the following types of effort:

**ACTIVE & AGGRESSIVE:** Demonstrated through engaged and assertive activity

**QUALITY:** Demonstrated through essential character of conscientious and serious activity

**QUANTITY:** Demonstrated through a measurable number of activities

**SCOPE & INTENSITY:** Demonstrated through a rigorous approach to an appropriate and purposeful range of activities

**TIMING:** Demonstrated through engagement efforts beyond simple solicitation, initiated early in the process

**GFE EVALUATION – PHASE 2 – Team Review****GFE Team completes:**

- Review of activities included on the rubric
- Review of the intent to award and sound reasoning submitted by Prime
- Bid analysis to confirm if any bid submitted met the DBE goal
- Review average of other bidders DBE goal achievement
- Team review of combined efforts documented in Phase 1 and 2 constitute final GFE determination

**Rating Scale:**

- **GFE Approval:**  
**Bona Fide = 6 or more categories color coded green.**  
Genuine effort characterized by sincere and earnest activities – “Solicitation” and “Sound Reasoning” must be green
- **GFE Approval:**  
**Sufficient = 5 or more categories color coded green or yellow**  
Adequate effort documented with a variety of quality activities – “Solicitation” and “Sound Reasoning” must be green or yellow
- **GFE Denial:**  
**Pro Forma efforts = 4 or less categories color coded green or yellow.** Perfunctory effort characterized by routine or superficial activities

**Green = Exceeds expectations**

**Yellow = Meets expectations**

**Red = Areas in need of attention and/or absence of documentation**

**See OBOEC Rubric Analysis Feedback**

Excerpt from Appendix A to 49 CFR Part 26:

V. In determining whether a bidder has made good faith efforts, it is essential to scrutinize its documented efforts. At a minimum, you must review the performance of other bidders in meeting the contract goal. For example, when the apparent successful bidder fails to meet the contract goal, but others meet it, you may reasonably raise the question of whether, with additional efforts, the apparent successful bidder could have met the goal. If the apparent successful bidder fails to meet the goal but meets or exceeds the average DBE participation obtained by other bidders, you may view this, in conjunction with other factors, as evidence of the apparent successful bidder having made good faith efforts. As provided in §26.53(b)(2)(vi), you must also require the contractor to submit copies of each DBE and non-DBE subcontractor quote submitted to the bidder when a non-DBE subcontractor was selected over a DBE for work on the contract to review whether DBE prices were substantially higher; and contact the DBEs listed

<b>GFE RUBRIC ANALYSIS</b>	
OBOEC DECISION	APPROVAL OR DENIAL
Prime Contractor	
Proposal	
Project	
Bid Letting	
DBE Goal Amount	
DBE Goal Amount Achieved	
<b>Bid Analysis</b>	
Goal %	Achieved %
Apparent Low Bidder	%
Bidder B	
Bidder C	
<b>Average of OTHER Bidders (Not including Apparent Low Bidder)</b>	
<b>DBE Quotes Received</b>	
<b>DBE Quotes Awarded</b>	
<b>DBE Quote(s) Rejected</b>	<b>Rejected Quote Analysis</b>
<b>DBE Quote(s) Awarded</b>	<b>Awarded DBE Amount</b>

## **APPENDIX E**

### **Good Faith Effort Best Practices**

This list is not a set of requirements; it is a list of potential strategies

#### **Primes**

- Prime contractor open houses inviting DBE firms to see the bid “war room” or providing technical assistance.
- Participate in speed networking and mosaic exercises as arranged by DBE office.
- Host information sessions not directly associated with a bid letting.
- Participate in a formal mentor protégé or joint venture with a DBE firm.
- Participate in WisDOT advisory committees i.e. TRANSAC, or Mega Project committee meetings.
- Facilitate a small group DBE ‘training session’ clarifying how your firm prepares for bid letting, evaluates subcontractors, preferred qualifications, and communication methods.
- Encourage subcontractors to solicit and highlight DBE participation in their quotes to you.
- Quality of communication, not quantity creates the best results. Contractors should be thorough in communicating with DBE firms before the bid and provide any assistance requested to assure best possible bid.

#### **DBE**

- DBE firms should contact primes as soon as possible with questions regarding their quotes or bid; seven days prior is optimal.
- Continually check for contract addendums on the HCCI website through the Thursday prior to letting to stay abreast of changes.
- Review the status of contracts on the HCCI website reviewing the ‘apparent low bidder’ list and bid tabs at a minimum.
- Prepare a portfolio or list of related projects and prime and supplier references; be sure to note transportation related projects of similar size and scope, firm expertise and staffing.
- Participate in DBE office assessment programs.
- Participate on advisory and mega-project committees.
- Sign up to receive the DBE Contracting Update.
- Consider membership in relevant industry or contractor organizations.
- Active participation is a must. Quote as many projects as you can reasonably work on; quoting the primes and bidding as a prime with the Department are the only ways to get work.

**APPENDIX F**  
**Good Faith Effort Evaluation Guidance**  
*Appendix A of 49 CFR Part 26*

I. When, as a recipient, you establish a contract goal on a DOT-assisted contract for procuring construction, equipment, services, or any other purpose, a bidder must, in order to be responsible and/or responsive, make sufficient good faith efforts to meet the goal. The bidder can meet this requirement in either of two ways. First, the bidder can meet the goal, documenting commitments for participation by DBE firms sufficient for this purpose. Second, even if it doesn't meet the goal, the bidder can document adequate good faith efforts. This means that the bidder must show that it took all necessary and reasonable steps to achieve a DBE goal or other requirement of this part which, by their scope, intensity, and appropriateness to the objective, could reasonably be expected to obtain sufficient DBE participation, even if they were not fully successful.

II. In any situation in which you have established a contract goal, Part 26 requires you to use the good faith efforts mechanism of this part. As a recipient, you have the responsibility to make a fair and reasonable judgment whether a bidder that did not meet the goal made adequate good faith efforts. It is important for you to consider the quality, quantity, and intensity of the different kinds of efforts that the bidder has made, based on the regulations and the guidance in this Appendix.

The efforts employed by the bidder should be those that one could reasonably expect a bidder to take if the bidder were actively and aggressively trying to obtain DBE participation sufficient to meet the DBE contract goal. Mere pro forma efforts are not good faith efforts to meet the DBE contract requirements. We emphasize, however, that your determination concerning the sufficiency of the firm's good faith efforts is a judgment call. Determinations should not be made using quantitative formulas.

III. The Department also strongly cautions you against requiring that a bidder meet a contract goal (i.e., obtain a specified amount of DBE participation) in order to be awarded a contract, even though the bidder makes an adequate good faith efforts showing. This rule specifically prohibits you from ignoring bona fide good faith efforts.

IV. The following is a list of types of actions which you should consider as part of the bidder's good faith efforts to obtain DBE participation. It is not intended to be a mandatory checklist, nor is it intended to be exclusive or exhaustive. Other factors or types of efforts may be relevant in appropriate cases.

A. (1) Conducting market research to identify small business contractors and suppliers and soliciting through all reasonable and available means the interest of all certified DBEs that have the capability to perform the work of the contract. This may include attendance at pre-bid and business matchmaking meetings and events, advertising and/or written notices, posting of Notices of Sources Sought and/or Requests for Proposals, written notices or emails to all DBEs listed in the State's directory of transportation firms that specialize in the areas of work desired (as noted in the DBE directory) and which are located in the area or surrounding areas of the project.

(2) The bidder should solicit this interest as early in the acquisition process as practicable to allow the DBEs to respond to the solicitation and submit a timely offer for the subcontract. The bidder should determine with certainty if the DBEs are interested by taking appropriate steps to follow up initial solicitations.

B. Selecting portions of the work to be performed by DBEs in order to increase the likelihood that the DBE goals will be achieved. This includes, where appropriate, breaking out contract work items into economically feasible units (for example, smaller tasks or quantities) to facilitate DBE participation, even when the prime contractor might otherwise prefer to perform these work items with its own forces. This may include, where possible, establishing flexible timeframes for performance and delivery schedules in a manner that encourages and facilitates DBE participation.

C. Providing interested DBEs with adequate information about the plans, specifications, and requirements of the contract in a timely manner to assist them in responding to a solicitation with their offer for the subcontract.

D. (1) Negotiating in good faith with interested DBEs. It is the bidder's responsibility to make a portion of the work available to DBE subcontractors and suppliers and to select those portions of the work or material needs consistent with the available DBE subcontractors and suppliers, so as to facilitate DBE participation. Evidence of such negotiation includes the names, addresses, and telephone numbers of DBEs that were considered; a description of the information provided regarding the plans and specifications for the work selected for subcontracting; and evidence as to why additional Agreements could not be reached for DBEs to perform the work.

(2) A bidder using good business judgment would consider a number of factors in negotiating with subcontractors, including DBE subcontractors, and would take a firm's price and capabilities as well as contract goals into consideration. However, the fact that there may be some additional costs involved in finding and using DBEs is not in itself sufficient reason for a bidder's failure to meet the contract DBE goal, as long as such costs are reasonable. Also, the ability or desire of a prime contractor to perform the work of a contract with its own organization does not relieve the bidder of the responsibility to make good faith efforts. Prime contractors are not, however, required to accept higher quotes from DBEs if the price difference is excessive or unreasonable.

E. (1) Not rejecting DBEs as being unqualified without sound reasons based on a thorough investigation of their capabilities. The contractor's standing within its industry, membership in specific groups, organizations, or associations and political or social affiliations (for example union vs. non-union status) are not legitimate causes for the rejection or non-solicitation of bids in the contractor's efforts to meet the project goal. Another practice considered an insufficient good faith effort is the rejection of the DBE because its quotation for the work was not the lowest received. However, nothing in this paragraph shall be construed to require the bidder or prime contractor to accept unreasonable quotes in order to satisfy contract goals.

(2) A prime contractor's inability to find a replacement DBE at the original price is not alone sufficient to support a finding that good faith efforts have been made to replace the original DBE. The fact that the contractor has the ability and/or desire to perform the contract work with its own forces does not relieve the contractor of the obligation to make good faith efforts to find a replacement DBE, and it is not a sound basis for rejecting a prospective replacement DBE's reasonable quote.

F. Making efforts to assist interested DBEs in obtaining bonding, lines of credit, or insurance as required by the recipient or contractor.

G. Making efforts to assist interested DBEs in obtaining necessary equipment, supplies, materials, or related assistance or services.



H. Effectively using the services of available minority/women community organizations; minority/women contractors' groups; local, State, and Federal minority/women business assistance offices; and other organizations as allowed on a case-by-case basis to provide assistance in the recruitment and placement of DBEs.

V. In determining whether a bidder has made good faith efforts, it is essential to scrutinize its documented efforts. At a minimum, you must review the performance of other bidders in meeting the contract goal. For example, when the apparent successful bidder fails to meet the contract goal, but others meet it, you may reasonably raise the question of whether, with additional efforts, the apparent successful bidder could have met the goal. If the apparent successful bidder fails to meet the goal, but meets or exceeds the average DBE participation obtained by other bidders, you may view this, in conjunction with other factors, as evidence of the apparent successful bidder having made good faith efforts. As provided in §26.53(b)(2)(vi), you must also require the contractor to submit copies of each DBE and non-DBE subcontractor quote submitted to the bidder when a non-DBE subcontractor was selected over a DBE for work on the contract to review whether DBE prices were substantially higher; and contact the DBEs listed on a contractor's solicitation to inquire as to whether they were contacted by the prime. Pro forma mailings to DBEs requesting bids are not alone sufficient to satisfy good faith efforts under the rule.

VI. A promise to use DBEs after contract award is not considered to be responsive to the contract solicitation or to constitute good faith efforts.

[79 FR 59600, Oct. 2, 2014]

## **APPENDIX G**

### **(SAMPLE) Forms DT1506 and DT1202**

**Official Form DT1506 can be found here:** <https://wisconsin.gov/Documents/formdocs/dt1506.pdf>

**COMMITMENT TO SUBCONTRACT TO DBE**



Wisconsin Department of Transportation

DT1506 12/2021 s.84.06(2) Wis. Stats.  Non-Traditional Project

Project ID: \_\_\_\_\_  
 Proposal #: \_\_\_\_\_

Prime Contractor: \_\_\_\_\_  
 County: \_\_\_\_\_

Letting Date: \_\_\_\_\_  
 Total \$ Value of Prime Contract: \$ \_\_\_\_\_  
 DBE Contract Goal: \_\_\_\_\_ %  
 DBE Goal Achieved: 0.00 %

This contract requires that a specified percentage of the work be subcontracted to a disadvantaged business enterprise and that this information be submitted as described in ASP-3. The submittal of this form with the bid proposal constitutes your DBE commitment. Include Attachment A for DBEs included on commitment.

**This form must be completed and returned for this proposal. See page 2 for instructions.**

1. DBE Firm	2. Work or Items to be subcontracted	3. Supplier Y/N	4. Trucking Only	5. DBE Full Subcontract \$	6. DBE Amount for Credit \$
			O# L#		
			O# L#		
			O# L#		
			O# L#		
			O# L#		
			O# L#		
			O# L#		
			O# L#		
			O# L#		
			O# L#		
			O# L#		
			O# L#		
			O# L#		
			O# L#		
			O# L#		
			O# L#		
			O# L#		
			O# L#		
			O# L#		
			O# L#		
			O# L#		
			O# L#		
				\$ 0.00	\$ 0.00

Government Use Only Approved Amounts	
A =	\$ %
V =	\$ %
Total =	\$ %
Signature: _____	
Date: _____	
Good faith effort approved: Yes <input type="checkbox"/> No <input type="checkbox"/>	

\_\_\_\_\_  
**Prime Representative Signature & Date**

\_\_\_\_\_  
**DBE Office Signature & Date Approved**

**COMMITMENT TO SUBCONTRACT TO DBE  
ATTACHMENT A**

**CONFIRMATION OF PARTICIPATION**

Project I.D.:	Proposal Number:
Letting Date:	

Name of DBE Firm Participating in this Contract:	
Name of the Prime/Subcontractor who hired the DBE Firm: <i>(list all names of tiers if more than one)</i>	
Type of Work or Type of Material Supplied:	
Total Subcontract Value:	Total DBE Credit Value:

<b>FOR PRIME CONTRACTORS ONLY:</b> I certify that I made arrangements with the participating DBE firm to perform the type of work listed or supply the material indicated above for the subcontract value listed above.	Prime Contractor Representative's Signature
	Prime Contractor Representative's Name (Print Name)
	Prime Contractor (Print Company Name)
	Date

<b>FOR PARTICIPATING DBE FIRMS ONLY:</b> I certify that I made arrangements with the Prime Contractor or the Hiring Contractor to perform the type of work or supply the material indicated above for the subcontract value listed above.	Participating DBE Firm Representative's Signature	Date
	Participating DBE Firm Representative's Name (Print Name)	
	Participating DBE Firm (Print Company Name)	
	DBE Firm's Address:	
<b>FOR DBE TRUCKING FIRMS ONLY:</b> I certify that I will utilize, for DBE credit, only trucks listed on my WisDOT approved Schedule of Owned/Leased Vehicles for DBE Credit form and I will be utilizing the number of trucks as listed below.		

# Owned Trucks	# Leased Trucks	# DBE-Owned Leased Trucks	# Non-DBE-Owned Leased Trucks

Off site Hauling



**DOCUMENTATION OF GOOD FAITH EFFORT**  
 Wisconsin Department of Transportation  
 DT1202.....3/2020



Project ID *****	Proposal No. *****	Letting *****
Prime Contractor *****	County *****	
Person Submitting Document *****	Telephone Number *****	
Address *****	Email Address *****	

All bidders must undertake necessary and reasonable steps to achieve the assigned DBE contract goal per federal regulatory guidance at 49 CFR Part 26. Bidders use this form to document all efforts employed to meet the assigned goal as a record of contractor good faith efforts (GFE). Refer to ASP3 or 49 CFR Part 26 for guidance on actions that demonstrate good faith effort.

It is critical to list all efforts, attach documentation, and follow the instructions to complete this submission. Documentation of good faith effort includes copies of each DBE and non-DBE subcontractor quote submitted to the bidder for the same line items. Utilize the sample documentation logs to document and organize efforts.

Submit good faith effort documentation per ASP-3 guidelines.

**Instructions:** Provide a narrative description of all activities pursued to demonstrate good faith efforts, any corresponding documentation, and applicable explanation on separate pages. Include the following items, organized in the order listed below.

**1. Solicitation Documentation:**

- a. **Purpose:** To identify all reasonable and available activities the bidder performed to solicit the interest of all certified DBEs who have the capacity and ability to perform work on the project. All solicitation efforts should begin as early as possible to ensure DBEs have ample time to respond and ask questions.
- b. **Action:** Identify and list all activities engaged in to solicit DBEs using all reasonable and available means such as written notice and follow-up communications; substantive conversations; pre-bid meetings; networking events; market research; advertising.

**2. Selected Work Items Documentation:**

- a. **Purpose:** To ensure that all work items are broken out into economically feasible units to facilitate DBE participation. This must occur even when you prefer to perform the work yourself.
- b. **Action:** Identify economically feasible work units to be performed by DBEs to include activities such as: list of work items to be performed; breaking up of large work items into smaller tasks or quantities; flexible time frames for performance and delivery schedules.

**3. Documentation of Project Information provided to Interested DBEs:**

- a. **Purpose:** To provide interested DBEs with adequate information about the plans, specifications, and any other contractual requirements in a timely manner to assist DBEs in response to solicitation.
- b. **Action:** Provide DBEs access to plans, specifications, and other contract requirements. Early solicitation allows ample opportunity to provide project information, links to Let advertisements, and substantive engagement with DBEs.

**4. → Documentation of Negotiation with Interested DBEs:**

**a. → Purpose:** To ensure that negotiations with interested DBEs were made in good faith providing evidence as to why agreements could not be reached for DBEs to perform work.

**b. → Action:** Provide sufficient evidence to demonstrate that good faith negotiations took place. Merely sending out solicitations requesting bids from DBEs does not constitute sufficient good faith efforts. A bidder using good business judgment considers a number of factors in negotiating with all subcontractors, and the firm's price and capabilities in addition to contract goals are taken into consideration. However, the fact that there may be some additional costs involved in finding and using DBEs is not in itself sufficient reason for failing to meet the DBE goal as long as costs are reasonable. (see 49 CFR Part 26 Appendix A)

**5. → Documentation of Sound Reason for Rejecting DBEs:**

**a. → Purpose:** To ensure that bidders avoid rejecting DBEs as unqualified without sound reasons. Reasons for rejection must be based on thorough investigation of DBE capabilities.

**b. → Action:** Provide sufficient evidence to demonstrate that DBE was rejected for sound reasons such as past performance, relevant business experience and stability, safety record, business ethic and integrity, technical capacity, other tangible factors.

**6. → Documentation of Assistance to Interested DBEs - Bonding, Credit, Insurance, Equipment, Supplies/Materials:**

**a. → Purpose:** To assist interested DBEs in obtaining bonds, lines of credit, insurance, equipment, supplies, materials, and other assistance or services.

**b. → Action:** Assist interested DBEs in obtaining bonding, lines of credit or insurance, and provide technical assistance or information related to plans, specifications, and project requirements. Assist DBEs in obtaining equipment, supplies, materials or other services related to meeting project requirements (excluding supplies or equipment the DBE purchases from the prime).

**7. → Documentation of outreach to Minority, Women, and Community Organizations and other DBE Business Development Support:**

**a. → Purpose:** To effectively use the services of minority, women, and community organizations as well as contractors' groups, local, state, and federal business assistance offices and organization that provide assistance in recruiting and supporting DBEs, as well as participation in activities that support DBE business development.

**b. → Action:** Contact organizations and agencies for assistance in contacting, recruiting, and providing support to DBE subcontractors, suppliers, manufacturers, and truckers at least 14 days before bid opening. Participate in or host activities such as networking events, mentor-protégé programs, small business development workshops, and others consistent with DBE support.

Return to:  
Wisconsin Department of Transportation  
DBE Program Office  
PO Box 7965  
Madison, WI 53707-7965  
DBE\_Alert@dot.wi.gov

I certify that I have utilized comprehensive good faith efforts to solicit and utilize DBE firms to meet the DBE participation requirements of this contract proposal, as demonstrated by my responses and as specified in Additional Special Provision 3 (ASP-3).

I certify that the information given in the Documentation of Good Faith Efforts is true and correct to the best of my knowledge and belief.

I further understand that any willful falsification, fraudulent statement, or misrepresentation will result in appropriate sanctions, which may involve debarment and/or prosecution under applicable state (Trans 504) and Federal laws.

		(Bidder/Authorized Representative Signature)
		_____
		(Print Name)
		_____
		(Title)

### Good-Faith-Effort--Sample-Documentation-Logs

The sample logs below are provided as guides rather than exhaustive list. See ASP3, Appendix A for additional examples of demonstrable good faith efforts. Attach documentation for each activity listed.

Acceptable forms of documentation include copies of solicitations sent to DBEs, notes from substantive conversations and negotiations with DBEs, copies of advertisements placed, email communications, all quotes received from DBEs and from all subcontractors who were considered alongside DBE quotes, proof of attendance at applicable networking events; flyers for events or workshops for DBEs offered by the prime, and other physical records of good faith efforts activities.

#### SOLICITATION LOG

Date	Activity	Name of DBE Solicited	Follow-up
4/1/2020	Sent May-Let solicitation	Winterland Electric	Spoke with Mark Winterland on 4/15/20 to ask if he would quote.

#### SELECTED WORK ITEMS SOLICITED LOG

Work Type	DBE Firm	Contact Person	Date	Contact Mode
Pavement Marking	ABC Marking	Leslie Lynch	4/1/2020	Email; phone
	#1 Marking Co.	Mark Smart	4/1/2020	Email; left VM
Electrical	Winterland Electric	Tabitha Tinker	4/3/2020	Email; left VM
	Superstar Wiring	Jose Huascar	4/3/2020	Email; phone

#### INFORMATION PROVIDED LOG

Request Date	DBE Firm	Information Requested & Provided	Response Date
4/1/2020	Winterland Electric	Requested info on electrical requirements; provided plan and link to specs	4/3/2020
4/21/2020	Absolute Construction	Wanted to know how and when supplies are paid for by WisDOT; referred to spec that covers stockpiling	4/21/2020

#### NEGOTIATIONS LOG

Date	DBE Firm	Contact Name	Work Type	Quotes Rec'd?	Considered for project?	If not selected, why?
4/12/2020	ABC Landscape	John Dean	Erosion Control	Yes	No	Cannot perform all items
4/17/2020	Wild Ferns	Sandy Lynn	Erosion Control	Yes	Yes	
4/20/2020	#1 Marking	Mark Smart	Electrical	Yes	Yes	

#### ASSISTANCE LOG

Date	DBE Firm	Contact Person	Assistance Provided
4/1/2020	ABC Sawing	Jackie Swiggle	Informed DBE on how to obtain bonding
4/17/2020	Supreme Construction	Winston Walters	Provided contact for wholesale supply purchase

#### OUTREACH & BUSINESS DEVELOPMENT LOG

Date	Agency/Organization Contacted	Contact Person	Assistance Requested
4/1/2020	Women in Construction	LaTonya Klein	Contact information for woman-owned suppliers
4/28/2020	WBIC	Sam Smith	Asked for information to provide to DBE regarding financing programs through WBIC

Official Form DT1202 can be found here: <https://wisconsindot.gov/pages/global-footer/formdocs/default.aspx>



**ADDITIONAL SPECIAL PROVISION 4**

This special provision does not limit the right of the department, prime contractor, or subcontractors at any tier to withhold payment for work not acceptably completed or work subject to an unresolved contract dispute.

**Payment to First-Tier Subcontractors**

Within 10 calendar days of receiving a progress payment for work completed by a subcontractor, pay the subcontractor for that work. The prime contractor may withhold payment to a subcontractor if, within 10 calendar days of receipt of that progress payment, the prime contractor provides written notification to the subcontractor and the department documenting "just cause" for withholding payment.

The prime contractor is not allowed to withhold retainage from payments due subcontractors.

**Payment to Lower-Tier Subcontractors**

Ensure that subcontracting agreements at all tiers provide prompt payment rights to lower-tier subcontractors that parallel those granted first-tier subcontractors in this provision.

**Additional Special Provision 6**  
**ASP 6 - Modifications to the standard specifications**

*Make the following revisions to the standard specifications:*

**415.3.16 Tolerance in Pavement Thickness**

*Replace the entire text with the following effective with the November 2021 letting:*

**415.3.16.1 General**

- (1) Construct the plan thickness or thicker. The department will accept pavement thickness based on the results of department-performed acceptance testing conforming to:

Magnetic Pulse Induction .....	CMM 870: ASTM E3209 WTM
Probing.....	CMM 870: WTP C-002
Preplacement Measurement .....	CMM 870: WTP C-003

**415.3.16.2 Pavement Units**

**415.3.16.2.1 Basic Units**

- (1) Basic unit is defined as a slip formed, single lane, with a minimum lane width of 10 feet, measured, from the pavement edge to the adjacent longitudinal joint; from one longitudinal joint to the next; or between pavement edges if there is no longitudinal joint.

**415.3.16.2.2 Special Units**

- (2) Establish special units for areas of fillets, intersections, gaps, gores, shoulders, ramps, pavement lanes less than 10 feet wide and other areas not included in basic units.

**415.3.16.3 Test Plate Locations**

- (1) Place department-furnished test plates. Within 5 business days after paving, enter the sequential number and associated position data into MRS available at:

<http://www.atwoodsystems.com/>

- (2) Contractor will maintain plate location markings for 10 business days after paving.

**415.3.16.4 Acceptance Testing**

**415.3.16.4.1 Basic Units**

**415.3.16.4.1.2 Magnetic Pulse Induction**

- (1) The department will measure thickness within 10 business days of paving. Upon completion of the project thickness testing, the department will provide the test results to the contractor within 5 business days.
- (2) Department will establish a project reference plate at the start of each paving stage. Project reference plate will be measured before each day of testing. Department will notify the contractor of project reference plate locations before testing.
- (3) If the random plate test result falls within 80 to 50 percent pay range specified in 415.5.2, the department will measure the second plate in that unit. The department will notify the contractor immediately if the average of the 6 readings falls within the 80 to 50 percent pay range.
- (4) If an individual random plate test result is more than 1 inch thinner than contract plan thickness, the pavement is unacceptable. Department will determine limits of unacceptable pavement by performing the following:
- The engineer will test each consecutive plate stationed ahead and behind until the thickness test result is plan thickness or greater.
  - The engineer will direct the contractor to core the hardened concrete to determine the extent of the unacceptable area. In each direction, the contractor shall take cores at points approximately 20 feet from the furthest out of specification plate towards the plate that is plan thickness of greater. Once a core is within 80 to 100 percent pay range, the coring is complete and the limits of unacceptable pavement extend from the stationing between the core test results of 80 to 100 percent payment, inclusive of all unacceptable core and plate test results.
  - The contractor shall perform coring according to AASHTO T24. The department will evaluate the results according to AASHTO T148
  - The contractor shall fill core holes with concrete or mortar.

**415.3.16.4.2 Special Units**

**415.3.16.4.2.1 Magnetic Pulse Induction**

- (1) The department will measure thickness within 10 business days of paving. Upon completion of the project thickness testing, the department will provide the test results to the contractor within 5 business days.
- (2) Department will establish a project reference plate at the start of each paving stage. Project reference plate will be measured before each day of testing. Department will notify the contractor of project reference plate locations before testing.
- (3) If the random plate test result falls within 80 to 50 percent pay range specified in 415.5.2, the department will measure the second plate in that unit. The department will notify the contractor immediately if the average of the 6 readings falls within the 80 to 50 percent pay range.
- (4) If an individual random plate test result is more than 1 inch thinner than contract plan thickness, the department will measure the second plate in that unit. If both plates are required to be measured, then all six thickness measurements will be averaged for that unit. If the average of the six measurements is more than 1 inch thinner than contract plan thickness, the pavement is unacceptable.

**415.3.16.4.2.2 Probing**

- (1) The department will measure slip form special units during concrete placement. Upon completion of the project thickness testing, the department will provide the test results to the contractor within 5 business days.
- (2) Department will probe 2 random locations within the special unit. The average of the two readings will be the reported measurement for the special unit.

**415.3.16.4.2.3 Preplacement Measurement**

- (1) The department will measure non-slip form special units before concrete placement.
- (2) Thickness corrections will be made to a conforming thickness by reshaping the base aggregate before the pavement is placed.

**415.5.2 Adjusting Pay for Thickness**

Replace the entire text with the following effective with the November 2021 letting:

- (1) The department will adjust pay for pavement thickness under the Nonconforming Thickness Concrete Pavement administrative item as follows:

FOR PAVEMENT THINNER THAN PLAN THICKNESS BY:	PERCENT OF THE CONTRACT UNIT PRICE
> 1/4 inch but <= 1/2 inch	80
> 1/2 inch but <= 3/4 inch	60
> 3/4 inch but <= 1 inch	50

- (2) When pavement of unacceptable final thickness is determined, as specified in 415.3.16.4, the department will direct the contractor to either:
  - 1. Remove and replace unacceptable concrete pavement to the nearest joint with new concrete pavement of conforming thickness. The department will pay once for the area at the full contract price.
  - 2. If the unacceptable pavement is less than 100 LF, the department may allow the concrete to remain in place without payment for the unacceptable area.

**460.2.6 Recovered Asphaltic Binders**

Replace paragraph two with the following effective with the November 2021 letting:

- (2) The contractor may replace virgin binder with recovered binder up to the maximum percentage allowed under 460.2.5 without further testing. When the design percent asphalt binder replaced exceeds the allowable limits in 460.2.5, the contractor must:
  - Document adjustments made to the mix design in the mix design submittal.
  - Submit test results that indicate the mixture's asphaltic binder meets or exceeds the upper and lower temperature grade requirements the bid item designates.
    - If only one recycled asphaltic material source is used, furnish one of the following:
      - Test results from extracted and recovered binder from the resultant mixture.
      - Blending charts that indicate the resultant mixture's high and low temperature PG as an interpolation of the percent binder replaced between the virgin binder's and the recycled asphaltic material source binder's high and low temperature PG.
    - If two or more recycled asphaltic material sources are used, furnish test results from extracted and

recovered binder from the resultant mixture.

**501.2.6 Water**

*Retitle with the following effective with the November 2021 letting:*

**501.2.6 Mixing Water**

**501.2.6.2 Requirements**

*Replace paragraph two with the following effective with the November 2021 letting:*

- (2) Water from other sources must comply with the following:
  - Acidity, maximum of 0.1N NaOH to neutralize 200 mL of water; CMM 870: WTP C-001.....2 mL
  - Alkalinity, maximum of 0.1N HCL to neutralize 200 mL of water; CMM 870: WTP C-001 ..... 15 mL
  - Maximum sulphate (SO<sub>4</sub>); CMM 870: WTP C-001 ..... 0.05 percent
  - Maximum chloride; CMM 870: WTP C-001 ..... 0.10 percent
  - Maximum total solids; CMM 870: WTP C-001
    - Organic ..... 0.04 percent
    - Inorganic..... 0.15 percent

**501.3.2.2.2 Supplementary Cementitious Material**

*Replace the entire text with the following effective with the May 2022 letting:*

- (1) Replace 15 to 30 percent by weight of the total cementitious material content with approved SCMs for class I concrete as specified in 715.
- (2) Replace a maximum of 30 percent by weight of the total cementitious material content with approved SCMs for class II and class III concrete as specified in 716.
- (3) Limit Class F fly ash sources not on the APL to maximum 15 percent.
- (4) Minimum SCM content may be waived by the engineer.

**501.3.2.4.2 Air Entrainment**

*Replace paragraph two with the following effective with the November 2021 letting:*

- (2) Test fresh concrete air content according to AASHTO T152 or AASHTO TP118 at the contract-required frequency and as the engineer directs. Test concrete placed by pumping or belting at the point of discharge from the pump line or belt.

**501.3.7.1 Slump**

*Replace paragraph one with the following effective with the November 2021 letting:*

- (1) Use a 1-inch to 4-inch slump for concrete used in structures or placed in forms, except as follows:
  - Do not exceed a slump of 2 inches for grade E concrete.
  - Increase slump as specified in 502.3.5.3 for concrete placed underwater.
  - If BTS approves a concrete mixture using a superplasticizer, the contractor may increase slump for that mixture to a maximum of 9 inches without exceeding the maximum mix water allowed for that grade.

**531.5 Payment**

*Replace paragraph two with the following effective with the November 2021 letting:*

- (2) Payment for Concrete Masonry Ancillary Structures Type NS is full compensation for providing concrete for non-standard sign structure foundations; and for anchor rod assemblies. The department will pay separately for excavating and backfilling drilled shafts under the Drilling Shafts bid items.

*Replace paragraph five with the following effective with the November 2021 letting:*

- (5) Payment for the Foundation bid items is full compensation for providing concrete foundations; for anchor rod assemblies; for reinforcing steel; and for embedded conduit and electrical components. The department will pay separately for excavating and backfilling drilled shafts under the Drilling Shafts bid items.

**642.2.2.1 General**

*Replace paragraph one with the following effective with the November 2021 letting:*

- (1) Provide each field office with two rooms, separated by an interior door with a padlock. Ensure that each room has a separate exterior door and its own air conditioner. Locate the office where a quality internet connection can be achieved. Ensure quality cell phone reception is achievable inside the field office.

**701.3.1 General**

*Replace table 701-1 with the following effective with the November 2021 letting:*

**TABLE 701-1 TESTING AND CERTIFICATION STANDARDS**

TEST	TEST STANDARD	MINIMUM REQUIRED CERTIFICATION (any one of the certifications listed for each test)
Random Sampling	CMM 830.9.2	Transportation Materials Sampling Technician (TMS) TMS Assistant Certified Technician (ACT-TMS) Aggregate Technician I (AGGTEC-I) AGGTEC-I Assistant Certified Technician (ACT-AGG) PCC Technician I (PCCTEC-I) PCCTEC-I Assistant Certified Technician (ACT-PCC) Grading Technician I (GRADINGTEC-I) Grading Assistant Certified Technician (ACT-GRADING)
Sampling Aggregates	AASHTO T2 <sup>[1]</sup> <sup>[4]</sup>	TMS, ACT-TMS, AGGTEC-1, ACT-AGG
Percent passing the No. 200 sieve	AASHTO T11 <sup>[1]</sup>	AGGTEC-I, ACT-AGG
Fine & coarse aggregate gradation	AASHTO T27 <sup>[1]</sup>	
Aggregate moisture content	AASHTO T255 <sup>[1]</sup>	
Fractured faces	ASTM D5821 <sup>[1]</sup>	
Liquid limit	AASHTO T89	Aggregate Testing for Transportation Systems (ATTS)
Plasticity index	AASHTO T90 <sup>[3]</sup>	GRADINGTEC-I, or ACT-GRADING
Sampling freshly mixed concrete	AASHTO R60	PCCTEC-1 ACT-PCC
Air content of fresh concrete	AASHTO T152 <sup>[2]</sup> AASHTO TP118 <sup>[5]</sup>	
Air void system of fresh concrete	AASHTO TP118 <sup>[5]</sup>	
Concrete slump	AASHTO T119 <sup>[2]</sup>	
Concrete temperature	ASTM C1064	
Making and curing concrete specimens	AASHTO T23	
Moist curing for concrete specimens	AASHTO M201	
Concrete compressive strength	AASHTO T22	Concrete Strength Tester (CST) CST Assistant Certified Technician (ACT-CST)
Concrete flexural strength	AASHTO T97	
Concrete surface resistivity <sup>[2]</sup>	AASHTO T358	
Voids in aggregate	AASHTO T19	PCCTEC-II
Profiling	—	PROFILER

<sup>[1]</sup> As modified in CMM 860.

<sup>[2]</sup> As modified in CMM 870.

<sup>[3]</sup> A plasticity check, if required under individual QMP specifications, may be performed by an AGGTEC-I in addition to the certifications listed for liquid limit and plasticity index tests.

<sup>[4]</sup> Plant personnel may operate equipment to obtain samples under the direct observation of a TMS or higher.

<sup>[5]</sup> Consolidate by rodding.

**710.2 Small Quantities**

*Replace the entire text with the following effective with the November 2021 letting:*

- (1) The department defines small quantities as follows:
  - As specified in 715.1.1.2 for class I concrete.
  - Less than 50 cubic yards of class II ancillary concrete placed under a single bid item.
- (2) For contracts with only small quantities of material subject to testing, modify the requirements of 710 as follows:

1. The contractor may submit an abbreviated quality control plan as allowed in 701.1.2.3.
  2. Provide one of the following for aggregate process control:
    - Documented previous testing dated within 120 calendar days. Provide gradation test results to the engineer before placing material.
    - Non-random start-up gradation testing.
- 

#### **710.4 Concrete Mixes**

Replace paragraph two with the following effective with the November 2021 letting:

- (2) At least 7 business days before producing concrete, document that materials conform to 501 unless the engineer allows or individual QMP specifications provide otherwise. Include the following:
  1. For mixes: quantities per cubic yard expressed as SSD weights and net water, water to cementitious material ratio, air content, and SAM number.
  2. For cementitious materials and admixtures: type, brand, and source.
  3. For aggregates: absorption, SSD bulk specific gravity, wear, soundness, freeze thaw test results if required, and air correction factor. Also include aggregate production records dated within 2 years if using those results in the design. Submit component aggregate gradations, aggregate proportions, and target combined blended aggregate gradations using the following:
    - DT2220 for combined aggregate gradations.
    - DT2221 for optimized aggregate gradations.
  4. For optimized concrete mixtures:
    - Complete the worksheets within DT2221 according to the directions.
    - Ensure the optimized aggregate gradations and the optimized mix design conform to WisDOT specifications and pass the built-in tests within DT2221.
    - Verify slip-form mixture workability according to AASHTO TP137 and conformance to specifications through required trial batching.
    - Submit the completed DT2221 to the engineer electronically. Include the trial batch test results with the mix design submittal.

Replace paragraph four with the following effective with the November 2021 letting:

- (4) Prepare and submit modifications to a concrete mix to the engineer for approval 3 business days before using that modified mix. Modifications requiring the engineer's approval include changes in:
    1. Source of any material. For paving and barrier mixes, a source change for fly ash of the same class does not constitute a mix design change.
    2. Quantities of cementitious materials.
    3. Addition or deletion of admixtures. Minor admixture dosage adjustments required to maintain air content or slump do not require engineer review or approval.
- 

#### **710.5.5 Strength**

Replace paragraph one with the following effective with the November 2021 letting:

- (1) Cast all 6" x 12" cylinders or all 6" x 6" x 21" beams in a set from the same sample. Do not cast more than one set of specimens from a single truckload of concrete. Mark each specimen to identify the lot and subplot or location on the project it represents.
- 

#### **710.5.6 Aggregate Testing**

Retitle and replace the entire text with the following effective with the November 2021 letting:

##### **710.5.6 Aggregate Testing During Concrete Production**

###### **710.5.6.1 General**

- (1) The department will accept gradation based on the results of department-performed acceptance testing.
- (2) The department and contractor will obtain samples using the same method. When belt sampling, contractor personnel shall obtain samples for the department under the direct observation of the department personnel. Contractor will define sampling method in the QMP or abbreviated QMP.

###### **710.5.6.2 Contractor Control Charts**

###### **710.5.6.2.1 General**

- (1) Test aggregate gradations during concrete production except as allowed for small quantities under 710.2. Required contractor testing will be performed using non-random samples.

- (2) Sample aggregates from either the conveyor belt or from the working face of the stockpiles.
- (3) Sample aggregates within 2 business days before placement for each mix design. Include this gradation on the control charts.
- (4) Report gradation test results and provide control charts to the engineer within 1 business day of obtaining the sample. Submit results to the engineer and electronically into MRS as specified in 701.1.2.7.
- (5) Conduct aggregate testing at the minimum frequency shown based on the anticipated daily cumulative plant production for each mix design. The contractor’s concrete production tests can be used for the same mix design on multiple contracts.

**TABLE 710-1 CONTRACTOR GRADATION TESTING FREQUENCY - CLASS I**

DAILY PLANT PRODUCTION RATE FOR WisDOT WORK	MINIMUM FREQUENCY
Gradation Report Before Placement	
1000 cubic yards or less	one test per day
more than 1000 cubic yards	two tests per day

**TABLE 710-2 CONTRACTOR GRADATION TESTING FREQUENCY - CLASS II**

MINIMUM FREQUENCY
Gradation Report Before Placement
One test per calendar week of production

**710.5.6.2.2 Optimized Aggregate Gradation Control Charts**

- (1) Determine the complete gradation using a washed analysis for both fine and coarse aggregates. Report results for the following:
  - 1 1/2", 1", 3/4", 1/2", 3/8", #4, #8, #16, #30, #50, #100, and #200 sieves.
  - Sum of volumetric percentages retained on No. 8, No. 16, and No. 30 sieves.
  - Sum of volumetric percentages retained on No. 30, No. 50, No. 100, and No. 200 sieves.
- (2) Calculate blended aggregate gradations using the mix design batch percentages for the component aggregates. Ensure the blended aggregate gradation conforms to the volumetric percent retained of the optimized aggregate gradation limits specified in table 501-4.
- (3) Throughout the contract, construct a 4-point running average of the volumetric percent retained for each sieve to determine if the blended aggregate gradation is within the tarantula curve limits specified in table 501-4.

**710.5.6.2.3 Combined Aggregate Gradation Control Charts**

- (1) Determine the complete gradation using a washed analysis for both fine and coarse aggregates. Report results for the 1 1/2", 1", 3/4", 1/2", 3/8", #4, #8, #16, #30, #50, #100, and #200 sieves.
- (2) Calculate blended aggregate gradations using the mix design batch percentages for the component aggregates. Ensure the blended aggregate gradation conforms to the percent passing by weight requirements of the combined aggregate gradation limits specified in table 501-4.
- (3) Throughout the contract, construct a 4-point running average of the percent passing by weight for each sieve to determine if the blended aggregate gradation is within the combined aggregate gradation limits specified in table 501-4.

**710.5.6.3 Department Acceptance Testing**

- (1) Department testing frequency is based on the quantity of each mix design placed under each individual WisDOT contract.
- (2) The department will split each sample, test for acceptance, and retain the remainder for a minimum of 10 calendar days.
- (3) The department will obtain the sample and deliver to regional testing lab in the same day. Department will report gradation test results to the contractor within 1 business day of being delivered to the lab. Department and contractor can agree to an alternative test result reporting timeframe; alternative timeframe is required to be documented in the QMP.
- (4) Additional samples may be taken at the engineer’s discretion due to change in condition.

**TABLE 710-3 DEPARTMENT GRADATION TESTING FREQUENCY**

CONCRETE CLASSIFICATION	MINIMUM DEPARTMENT FREQUENCY
Class I: Pavement	1 test per placement day for first 5 days of placement. If all samples are passing, reduced frequency is applied.
	Reduced frequency: 1 test per calendar week of placement
Class I: Structures	1 test per 250 CY placed <ul style="list-style-type: none"> <li>- Minimum of 1 test per substructure</li> <li>- Minimum of 1 test per superstructure</li> </ul>
Class I: Cast-in-Place Barrier	1 test per 500 CY placed
Class II	No minimum testing

### 710.5.7 Corrective Action

Replace the entire text with the following effective with the November 2021 letting:

#### 710.5.7.1 Optimized Aggregate Gradations

- (1) If the contractor's 4-point running average or a department test result of the volumetric percent retained exceeds the tarantula curve limits by less than or equal to 1.0 percent on a single sieve size, do the following:
  1. Notify the other party immediately.
  2. Perform corrective action documented in the QC plan or as the engineer approves.
  3. Document and provide corrective action results to the engineer as soon as they are available.
  4. Department will conduct two tests within the next business day after corrective action is complete.
  5. If blended aggregate gradations are within the tarantula curve limits by the second department test:
    - Continue with concrete production.
    - Contractor will include a break in the 4-point running average.
    - For Class I: Pavements, department will discontinue reduced frequency testing and will test at a frequency of 1 test per placement day. Once 5 consecutive samples are passing at the 1 test per placement day frequency, the reduced frequency testing will be reapplied.
  6. If blended aggregate gradations are not within the tarantula curve limits by the second department test:
    - Provide a new mix design with an increased cementitious content.
    - If the mix design already has a cementitious content of 565 or more pounds per cubic yard, provide a new mix design.
    - If the contract requires optimized aggregate gradations under 501.2.7.4.2.1(2), stop concrete production and submit a new mix design.
- (2) If the contractor's 4-point running average or a department test result of the volumetric percent retained exceeds the tarantula curve limits by more than 1.0 percent on one or more sieves, stop concrete production and submit a new mix design.
- (3) Department and contractor will sample and test aggregate of the new mix design at the frequency defined in 710.5.6.1.

#### 710.5.7.2 Combined Aggregate Gradations

- (1) If the contractor's 4-point running average or a department test result of the percent passing by weight exceeds the combined aggregate gradation limits by less than or equal to 1.0 percent on a single sieve size, do the following:
  1. Notify the other party immediately.
  2. Perform corrective action documented in the QC plan or as the engineer approves.
  3. Document and provide corrective action results to the engineer as soon as they are available.
  4. Department will conduct two tests within the next business day after corrective action is complete.
  5. If blended aggregate gradations are within the combined aggregate gradation limits by the second department test:
    - Continue with concrete production.
    - Contractor will include a break in the 4-point running average.



- For Class I: Pavements, department will discontinue reduced frequency testing and will test at a frequency of 1 test per placement day. Once 5 consecutive samples are passing at the 1 test per placement day frequency, the reduced frequency testing will be reapplied.
6. If blended aggregate gradations are not within the combined aggregate gradation limits by the second department test, stop concrete production and submit a new mix design.
- (2) If the contractor's 4-point running average or a department test result of the percent passing by weight exceeds the combined aggregate gradation limits by more than 1.0 percent on one or more sieves, stop concrete production and submit a new mix design.
- (3) Department and contractor will sample and test aggregate of the new mix design at the frequency defined in 710.5.6.1.

**715.3.1.1 General**

Replace paragraphs three and four with the following effective with the November 2021 letting:

- (3) Cast a set of 3 additional 6"x12" cylinders and test the concrete surface resistivity according to AASHTO T358. Perform this testing at least once per lot if total contract quantities are greater than or equal to the following:
- 20,000 square yards for pavements.
  - 5,000 linear feet for barriers.
  - 500 cubic yards for structure concrete.

Submit the resistivity to the nearest tenth into MRS for information only. Resistivity testing is not required for the following:

- Lot with less than 3 sublots.
  - Concrete items classified as ancillary.
  - Concrete placed under the following bid items:
    - Concrete Pavement Approach Slab
    - Concrete Masonry Culverts
    - Concrete Masonry Retaining Walls
- (4) Test the air void system at least once per lot and enter the SAM number in MRS for information only. SAM testing is not required for the following:
- For lots with less than 3 sublots.
  - High early strength (HES) concrete.
  - Special high early strength (SHES) concrete.
  - Concrete placed under the following bid items:
    - Concrete Pavement Approach Slab
    - Concrete Masonry Culverts
    - Concrete Masonry Retaining Walls
    - Steel Grid Floor Concrete Filled
    - Crash Cushions Permanent
    - Crash Cushions Permanent Low Maintenance
    - Crash Cushions Temporary

**715.3.1.2.3 Lots by Cubic Yard**

Replace the entire text with the following effective with the November 2021 letting:

- (1) Define standard lots and sublots conforming to the following:

**TABLE 715-1 CLASS I - LOT AND SUBLOT SIZES**

CONCRETE CLASSIFICATION	LOT SIZE	SUBLOT SIZE	NUMBER OF SUBLOTS PER LOT
Class I: Pavement	1250 cubic yards	250 cubic yards	5
Class I: Structures	250 cubic yards	50 cubic yards	5
Class I: Cast-in-Place Barrier	500 cubic yards	100 cubic yards	5

- (2) The contractor may include sublots less than or equal to 25 percent of the standard volume in the previous subplot. For partial sublots exceeding 25 percent of the standard volume, notify the engineer who will direct additional testing to represent that partial subplot.
- (3) An undersized lot is eligible for incentive payment under 715.5 if the lot has 3 or more sublots for that lot.

### **715.3.2 Strength Evaluation**

Replace the entire text with the following effective with the November 2021 letting:

#### **715.3.2.1 General**

- (1) The department will make pay adjustments for strength on a lot-by-lot basis using the compressive strength of contractor QC cylinders or the flexural strength of contractor QC beams.
- (2) Randomly select 2 QC specimens to test at 28 days for percent within limits (PWL). Compare the strengths of the 2 randomly selected QC specimens and determine the 28-day subplot average strength as follows:
  - If the lower strength divided by the higher strength is 0.9 or more, average the 2 QC specimens.
  - If the lower strength divided by the higher strength is less than 0.9, break one additional specimen and average the 2 higher strength specimens.

#### **715.3.2.2 Removal and Replacement**

##### **715.3.2.2.1 Pavement**

- (1) If a subplot strength is less than 2500 psi in compressive strength or 500 psi in flexural strength, the department may direct the contractor to core that subplot to determine its structural adequacy and whether to direct removal.
- (2) If the engineer directs coring, obtain three cores from the subplot in question. Have an HTCP-certified PCC technician I perform or observe core sampling according to AASHTO T24.
- (3) Have an independent consultant test cores according to AASHTO T24.
- (4) The department will assess concrete for removal and replacement based on a subplot-by-subplot analysis of core strength. Perform coring and testing, fill core holes with an engineer-approved non-shrink grout or concrete, and provide traffic control during coring.
- (5) The subplot pavement is conforming if the compressive strengths of all cores from the subplot are 2500 psi or greater.
- (6) The subplot pavement is nonconforming if the compressive strengths of any core from the subplot is less than 2500 psi. The department may direct removal and replacement or otherwise determine the final disposition of nonconforming material as specified in 106.5.

##### **715.3.2.2.2 Structures and Cast-in-Place Barrier**

- (1) The department will evaluate the subplot for possible removal and replacement if the 28-day subplot average compressive strength is lower than  $f'_c$  minus 500 psi. The value of  $f'_c$  is the design stress the plans show. The department may assess further strength price reductions or require removal and replacement only after coring the subplot.
- (2) The engineer may initially evaluate the subplot strength using a non-destructive method. Based on the results of non-destructive testing, the department may accept the subplot at the previously determined pay for the lot, or direct the contractor to core the subplot.
- (3) If the engineer directs coring, obtain three cores from the subplot in question. Have an HTCP-certified PCC technician I perform or observe core sampling according to AASHTO T24. Determine core locations, subject to the engineer's approval, that do not interfere with structural steel.
- (4) Have an independent consultant test cores according to AASHTO T24.
- (5) The department will assess concrete for removal and replacement based on a subplot-by-subplot analysis of core strength. Perform coring and testing, fill core holes with an engineer-approved non-shrink grout or concrete, and provide traffic control during coring.
- (6) If the 3-core average is greater than or equal to 85 percent of  $f'_c$ , and no individual core is less than 75 percent of  $f'_c$ , the engineer will accept the subplot at the previously determined pay for the lot. If the 3-core average is less than 85 percent of  $f'_c$ , or an individual core is less than 75 percent of  $f'_c$ , the engineer may require the contractor to remove and replace the subplot. The department may direct removal and replacement or otherwise determine the final disposition of nonconforming material as specified in 106.5.

**715.3.3 Aggregate**

*Replace the entire text with the following effective with the November 2021 letting:*

**715.3.3.1 General**

- (1) Except as allowed for small quantities in 710.2, test aggregate conforming to 710.5.6.

**715.3.3.2 Structures**

- (1) In addition to the aggregate testing required under 710.5.6, determine the fine and coarse aggregate moisture content for each sample.
- (2) Calculate target batch weights for each mix when production of that mix begins. Whenever the moisture content of the fine or coarse aggregate changes by more than 0.5 percent, adjust the batch weights to maintain the design w/cm ratio.
- 

**716.2.1 Class II Concrete**

*Replace paragraph two with the following effective with the May 2022 letting:*

- (2) Perform random QC testing at the following frequencies:
1. Test air content, temperature, and slump a minimum of once per 100 cubic yards for each mix design and placement method.
  2. Cast one set of 2 cylinders per 200 cubic yards for each mix design and placement method. Cast a minimum of one set of 2 cylinders per contract for each mix design and placement method. Random 28-day compressive strength cylinders are not required for HES or SHES concrete.
  3. For deck overlays, perform tests and cast cylinders once per 50 cubic yards of grade E concrete placed.
  4. For concrete base, one set of tests and one set of cylinders per 250 cubic yards.

The department will allow concrete startup test results for quantities under 50 cubic yards. Cast one set of 2 cylinders if using startup testing for acceptance.

---

**ERRATA**

**460.2.2.3 Aggregate Gradation Master Range**

Correct errata by adding US Standard equivalent sieve sizes.

- (1) Ensure that the aggregate blend, including recycled material and mineral filler, conforms to the gradation requirements in table 460-1. The values listed are design limits; production values may exceed those limits.

**TABLE 460-1 AGGREGATE GRADATION MASTER RANGE AND VMA REQUIREMENTS**

SIEVE	PERCENT PASSING DESIGNATED SIEVES							
	NOMINAL SIZE							
	No. 1 (37.5 mm) (1 1/2 inch)	No. 2 (25.0 mm) (1 inch)	No.3 (19.0 mm) (3/4 inch)	No. 4 (12.5 mm) (1/2 inch)	No. 5 (9.5 mm) (3/8 inch)	No. 6 (4.75 mm) (3/16 inch)	SMA No. 4 (12.5 mm) (1/2 inch)	SMA No. 5 (9.5 mm) (3/8 inch)
50.0-mm (2-inch)	100							
37.5-mm (1 1/2-inch)	90 - 100	100						
25.0-mm (1-inch)	90 max	90 - 100	100					
19.0-mm (3/4-inch)	—	90 max	90 - 100	100			100	
12.5-mm (1/2-inch)	—	—	90 max	90 - 100	100		90 - 97	100
9.5-mm (3/8-inch)	—	—	—	90 max	90 - 100	100	58 - 80	90 - 100
4.75-mm (No. 4)	—	—	—	—	90 max	90 - 100	25 - 35	35 - 45
2.36-mm (No. 8)	15 - 41	19 - 45	23 - 49	28 - 58	32 - 67	90 max	15 - 25	18 - 28
1.18-mm (No. 16)	—	—	—	—	—	30 - 55	—	—
0.60-mm (No. 30)	—	—	—	—	—	—	18 max	18 max
0.075-mm (No. 200)	0 - 6.0	1.0 - 7.0	2.0 - 8.0	2.0 - 10.0	2.0 - 10.0	6.0 - 13.0	8.0 - 11.0	8.0 - 12.0
% VMA	11.0 min	12.0 min	13.0 min	14.0 min <sup>[1]</sup>	15.0 min <sup>[2]</sup>	16.0 - 17.5	16.0 min	17.0 min

<sup>[1]</sup> 14.5 for LT and MT mixes.

<sup>[2]</sup> 15.5 for LT and MT mixes.

**715.5.1 General**

Correct the bid item number for Incentive Compressive Strength Concrete Pavement.

- (1) The department will pay incentive for compressive strength under the following bid items:

<u>ITEM NUMBER</u>	<u>DESCRIPTION</u>	<u>UNIT</u>
715.0502	Incentive Strength Concrete Structures	DOL
715.0603	Incentive Strength Concrete Barrier	DOL
715.0715	Incentive Flexural Strength Concrete Pavement	DOL
715.0720	Incentive Compressive Strength Concrete Pavement	DOL

### ADDITIONAL SPECIAL PROVISION 7

- A. Reporting 1<sup>st</sup> Tier and DBE Payments During Construction
1. Comply with reporting requirements specified in the department's Civil Rights Compliance, Contractor's User Manual, Sublets and Payments.
  2. Report payments to all DBE firms within 10 calendar days of receipt of a progress payment by the department or a contractor for work performed, materials furnished, or materials stockpiled by a DBE firm. Report the payment as specified in A(1) for all work satisfactorily performed and for all materials furnished or stockpiled.
  3. Report payments to all first tier subcontractor relationships within 10 calendar days of receipt of a progress payment by the department for work performed. Report the payment as specified in A(1) for all work satisfactorily performed.
  4. All tiers shall report payments as necessary to comply with the DBE payment requirement as specified in A(2).
  5. DBE firms must enter all payments to DBE and non-DBE firms regardless of tier.
  6. Require all first tier relationships, DBE firms and all other tier relationships necessary to comply with the DBE payment requirement in receipt of a progress payment by contractor to acknowledge receipt of payment as specified in A(1), (2), (3) and (4).
  7. All agreements made by a contractor shall include the provisions in A(1), (2), (3), (4), (5), and (6), and shall be binding on all first tier subcontractor relationships, all contractors and subcontractors utilizing DBE firms on the project, and all payments from DBE firms.
- B. Costs for conforming to this special provision are incidental to the contract.

NOTE: CRCS Prime Contractor payment is currently not automated and will need to be manually loaded into the Civil Rights Compliance System. Copies of prime contractor payments received (check or ACH) will have to be forwarded to [paul.ndon@dot.wi.gov](mailto:paul.ndon@dot.wi.gov) within 5 days of payment receipt to be logged manually.

\*\*\*Additionally, for information on Subcontractor Sublet assignments, Subcontractor Payments and Payment Tracking, please refer to the CRCS Payment and Sublets manual at:

<https://wisconsindot.gov/Documents/doing-bus/civil-rights/labornwage/crcs-payments-sublets-manual.pdf>

## **ADDITIONAL SPECIAL PROVISION 9**

### **Electronic Certified Payroll or Labor Data Submittal**

(1) Use the department's Civil Rights Compliance System (CRCS) to electronically submit certified payroll reports for contracts with federal funds and labor data for contracts with state funds only. Details are available online through the department's highway construction contractor information (HCCI) site on the Labor, Wages, and EEO Information page at:

<https://wisconsindot.gov/Pages/doing-bus/civil-rights/labornwage/default.aspx>

(2) Ensure that all tiers of subcontractors, including all trucking firms, either submit their weekly certified payroll reports (contracts with federal funds) or labor data (contracts with state funds only) electronically through CRCS. These payrolls or labor data are due within seven calendar days following the close of the payroll period. Every firm providing physical labor towards completing the project is a subcontractor under this special provision.

(3) Upon receipt of contract execution, promptly make all affected firms aware of the requirements under this special provision and arrange for them to receive CRCS training as they are about to begin their submittals. The department will provide training either in a classroom setting at one of our regional offices or by telephone. Contact Paul Ndon at (414) 438-4584 to schedule the training.

(4) The department will reject all paper submittals for information required under this special provision. All costs for conforming to this special provision are incidental to the contract.

(5) Firms wishing to export payroll/labor data from their computer system into CRCS should have their payroll coordinator contact Paul Ndon at [paul.ndon@dot.wi.gov](mailto:paul.ndon@dot.wi.gov). Not every contractor's payroll system is capable of producing export files. For details, see Section 4.8 CPR Auto Submit (Data Mapping) on pages 49-50; 66-71 of the CRCS Payroll Manual at:

<https://wisconsindot.gov/Documents/doing-bus/civil-rights/labornwage/crcs-payroll-manual.pdf>

**REQUIRED CONTRACT PROVISIONS  
FEDERAL-AID CONSTRUCTION CONTRACTS**

- I. General
- II. Nondiscrimination
- III. Non-segregated Facilities
- IV. Davis-Bacon and Related Act Provisions
- V. Contract Work Hours and Safety Standards Act Provisions
- VI. Subletting or Assigning the Contract
- VII. Safety: Accident Prevention
- VIII. False Statements Concerning Highway Projects
- IX. Implementation of Clean Air Act and Federal Water Pollution Control Act
- X. Certification Regarding Debarment, Suspension, Ineligibility and Voluntary Exclusion
- XI. Certification Regarding Use of Contract Funds for Lobbying
- XII. Use of United States-Flag Vessels:

**ATTACHMENTS**

A. Employment and Materials Preference for Appalachian Development Highway System or Appalachian Local Access Road Contracts (included in Appalachian contracts only)

**I. GENERAL**

1. Form FHWA-1273 must be physically incorporated in each construction contract funded under title 23, United States Code, as required in 23 CFR 633.102(b) (excluding emergency contracts solely intended for debris removal). The contractor (or subcontractor) must insert this form in each subcontract and further require its inclusion in all lower tier subcontracts (excluding purchase orders, rental agreements and other agreements for supplies or services). 23 CFR 633.102(e).

The applicable requirements of Form FHWA-1273 are incorporated by reference for work done under any purchase order, rental agreement or agreement for other services. The prime contractor shall be responsible for compliance by any subcontractor, lower-tier subcontractor or service provider. 23 CFR 633.102(e).

Form FHWA-1273 must be included in all Federal-aid design-build contracts, in all subcontracts and in lower tier subcontracts (excluding subcontracts for design services, purchase orders, rental agreements and other agreements for supplies or services) in accordance with 23 CFR 633.102. The design-builder shall be responsible for compliance by any subcontractor, lower-tier subcontractor or service provider.

Contracting agencies may reference Form FHWA-1273 in solicitation-for-bids or request-for-proposals documents, however, the Form FHWA-1273 must be physically incorporated (not referenced) in all contracts, subcontracts and lower-tier subcontracts (excluding purchase orders, rental agreements and other agreements for supplies or services related to a construction contract). 23 CFR 633.102(b).

2. Subject to the applicability criteria noted in the following sections, these contract provisions shall apply to all work

performed on the contract by the contractor's own organization and with the assistance of workers under the contractor's immediate superintendence and to all work performed on the contract by piecework, station work, or by subcontract. 23 CFR 633.102(d).

3. A breach of any of the stipulations contained in these Required Contract Provisions may be sufficient grounds for withholding of progress payments, withholding of final payment, termination of the contract, suspension / debarment or any other action determined to be appropriate by the contracting agency and FHWA.

4. Selection of Labor: During the performance of this contract, the contractor shall not use convict labor for any purpose within the limits of a construction project on a Federal-aid highway unless it is labor performed by convicts who are on parole, supervised release, or probation. 23 U.S.C. 114(b). The term Federal-aid highway does not include roadways functionally classified as local roads or rural minor collectors. 23 U.S.C. 101(a).

**II. NONDISCRIMINATION** (23 CFR 230.107(a); 23 CFR Part 230, Subpart A, Appendix A; EO 11246)

The provisions of this section related to 23 CFR Part 230, Subpart A, Appendix A are applicable to all Federal-aid construction contracts and to all related construction subcontracts of \$10,000 or more. The provisions of 23 CFR Part 230 are not applicable to material supply, engineering, or architectural service contracts.

In addition, the contractor and all subcontractors must comply with the following policies: Executive Order 11246, 41 CFR Part 60, 29 CFR Parts 1625-1627, 23 U.S.C. 140, Section 504 of the Rehabilitation Act of 1973, as amended (29 U.S.C. 794), Title VI of the Civil Rights Act of 1964, as amended (42 U.S.C. 2000d et seq.), and related regulations including 49 CFR Parts 21, 26, and 27; and 23 CFR Parts 200, 230, and 633.

The contractor and all subcontractors must comply with: the requirements of the Equal Opportunity Clause in 41 CFR 60-1.4(b) and, for all construction contracts exceeding \$10,000, the Standard Federal Equal Employment Opportunity Construction Contract Specifications in 41 CFR 60-4.3.

Note: The U.S. Department of Labor has exclusive authority to determine compliance with Executive Order 11246 and the policies of the Secretary of Labor including 41 CFR Part 60, and 29 CFR Parts 1625-1627. The contracting agency and the FHWA have the authority and the responsibility to ensure compliance with 23 U.S.C. 140, Section 504 of the Rehabilitation Act of 1973, as amended (29 U.S.C. 794), and Title VI of the Civil Rights Act of 1964, as amended (42 U.S.C. 2000d et seq.), and related regulations including 49 CFR Parts 21, 26, and 27; and 23 CFR Parts 200, 230, and 633.

The following provision is adopted from 23 CFR Part 230, Subpart A, Appendix A, with appropriate revisions to conform to the U.S. Department of Labor (US DOL) and FHWA requirements.

**1. Equal Employment Opportunity:** Equal Employment Opportunity (EEO) requirements not to discriminate and to take affirmative action to assure equal opportunity as set forth under laws, executive orders, rules, regulations (see 28 CFR Part 35, 29 CFR Part 1630, 29 CFR Parts 1625-1627, 41 CFR Part 60 and 49 CFR Part 27) and orders of the Secretary of Labor as modified by the provisions prescribed herein, and imposed pursuant to 23 U.S.C. 140, shall constitute the EEO and specific affirmative action standards for the contractor's project activities under this contract. The provisions of the Americans with Disabilities Act of 1990 (42 U.S.C. 12101 et seq.) set forth under 28 CFR Part 35 and 29 CFR Part 1630 are incorporated by reference in this contract. In the execution of this contract, the contractor agrees to comply with the following minimum specific requirement activities of EEO:

a. The contractor will work with the contracting agency and the Federal Government to ensure that it has made every good faith effort to provide equal opportunity with respect to all of its terms and conditions of employment and in their review of activities under the contract. 23 CFR 230.409 (g)(4) & (5).

b. The contractor will accept as its operating policy the following statement:

"It is the policy of this Company to assure that applicants are employed, and that employees are treated during employment, without regard to their race, religion, sex, sexual orientation, gender identity, color, national origin, age or disability. Such action shall include: employment, upgrading, demotion, or transfer; recruitment or recruitment advertising; layoff or termination; rates of pay or other forms of compensation; and selection for training, including apprenticeship, pre-apprenticeship, and/or on-the-job training."

**2. EEO Officer:** The contractor will designate and make known to the contracting officers an EEO Officer who will have the responsibility for and must be capable of effectively administering and promoting an active EEO program and who must be assigned adequate authority and responsibility to do so.

**3. Dissemination of Policy:** All members of the contractor's staff who are authorized to hire, supervise, promote, and discharge employees, or who recommend such action or are substantially involved in such action, will be made fully cognizant of and will implement the contractor's EEO policy and contractual responsibilities to provide EEO in each grade and classification of employment. To ensure that the above agreement will be met, the following actions will be taken as a minimum:

a. Periodic meetings of supervisory and personnel office employees will be conducted before the start of work and then not less often than once every six months, at which time the contractor's EEO policy and its implementation will be reviewed and explained. The meetings will be conducted by the EEO Officer or other knowledgeable company official.

b. All new supervisory or personnel office employees will be given a thorough indoctrination by the EEO Officer, covering all major aspects of the contractor's EEO obligations within thirty days following their reporting for duty with the contractor.

c. All personnel who are engaged in direct recruitment for the project will be instructed by the EEO Officer in the contractor's procedures for locating and hiring minorities and women.

d. Notices and posters setting forth the contractor's EEO policy will be placed in areas readily accessible to employees, applicants for employment and potential employees.

e. The contractor's EEO policy and the procedures to implement such policy will be brought to the attention of employees by means of meetings, employee handbooks, or other appropriate means.

**4. Recruitment:** When advertising for employees, the contractor will include in all advertisements for employees the notation: "An Equal Opportunity Employer." All such advertisements will be placed in publications having a large circulation among minorities and women in the area from which the project work force would normally be derived.

a. The contractor will, unless precluded by a valid bargaining agreement, conduct systematic and direct recruitment through public and private employee referral sources likely to yield qualified minorities and women. To meet this requirement, the contractor will identify sources of potential minority group employees and establish with such identified sources procedures whereby minority and women applicants may be referred to the contractor for employment consideration.

b. In the event the contractor has a valid bargaining agreement providing for exclusive hiring hall referrals, the contractor is expected to observe the provisions of that agreement to the extent that the system meets the contractor's compliance with EEO contract provisions. Where implementation of such an agreement has the effect of discriminating against minorities or women, or obligates the contractor to do the same, such implementation violates Federal nondiscrimination provisions.

c. The contractor will encourage its present employees to refer minorities and women as applicants for employment. Information and procedures with regard to referring such applicants will be discussed with employees.

**5. Personnel Actions:** Wages, working conditions, and employee benefits shall be established and administered, and personnel actions of every type, including hiring, upgrading, promotion, transfer, demotion, layoff, and termination, shall be taken without regard to race, color, religion, sex, sexual orientation, gender identity, national origin, age or disability. The following procedures shall be followed:

a. The contractor will conduct periodic inspections of project sites to ensure that working conditions and employee facilities do not indicate discriminatory treatment of project site personnel.

b. The contractor will periodically evaluate the spread of wages paid within each classification to determine any evidence of discriminatory wage practices.

c. The contractor will periodically review selected personnel actions in depth to determine whether there is evidence of discrimination. Where evidence is found, the contractor will promptly take corrective action. If the review indicates that the discrimination may extend beyond the actions reviewed, such corrective action shall include all affected persons.

d. The contractor will promptly investigate all complaints of alleged discrimination made to the contractor in connection with its obligations under this contract, will attempt to resolve such complaints, and will take appropriate corrective action



within a reasonable time. If the investigation indicates that the discrimination may affect persons other than the complainant, such corrective action shall include such other persons. Upon completion of each investigation, the contractor will inform every complainant of all of their avenues of appeal.

#### **6. Training and Promotion:**

a. The contractor will assist in locating, qualifying, and increasing the skills of minorities and women who are applicants for employment or current employees. Such efforts should be aimed at developing full journey level status employees in the type of trade or job classification involved.

b. Consistent with the contractor's work force requirements and as permissible under Federal and State regulations, the contractor shall make full use of training programs (i.e., apprenticeship and on-the-job training programs for the geographical area of contract performance). In the event a special provision for training is provided under this contract, this subparagraph will be superseded as indicated in the special provision. The contracting agency may reserve training positions for persons who receive welfare assistance in accordance with 23 U.S.C. 140(a).

c. The contractor will advise employees and applicants for employment of available training programs and entrance requirements for each.

d. The contractor will periodically review the training and promotion potential of employees who are minorities and women and will encourage eligible employees to apply for such training and promotion.

**7. Unions:** If the contractor relies in whole or in part upon unions as a source of employees, the contractor will use good faith efforts to obtain the cooperation of such unions to increase opportunities for minorities and women. 23 CFR 230.409. Actions by the contractor, either directly or through a contractor's association acting as agent, will include the procedures set forth below:

a. The contractor will use good faith efforts to develop, in cooperation with the unions, joint training programs aimed toward qualifying more minorities and women for membership in the unions and increasing the skills of minorities and women so that they may qualify for higher paying employment.

b. The contractor will use good faith efforts to incorporate an EEO clause into each union agreement to the end that such union will be contractually bound to refer applicants without regard to their race, color, religion, sex, sexual orientation, gender identity, national origin, age, or disability.

c. The contractor is to obtain information as to the referral practices and policies of the labor union except that to the extent such information is within the exclusive possession of the labor union and such labor union refuses to furnish such information to the contractor, the contractor shall so certify to the contracting agency and shall set forth what efforts have been made to obtain such information.

d. In the event the union is unable to provide the contractor with a reasonable flow of referrals within the time limit set forth in the collective bargaining agreement, the contractor will, through independent recruitment efforts, fill the employment vacancies without regard to race, color, religion, sex, sexual orientation, gender identity, national origin, age, or disability; making full efforts to obtain qualified and/or qualifiable minorities and women. The failure of a union to provide

sufficient referrals (even though it is obligated to provide exclusive referrals under the terms of a collective bargaining agreement) does not relieve the contractor from the requirements of this paragraph. In the event the union referral practice prevents the contractor from meeting the obligations pursuant to Executive Order 11246, as amended, and these special provisions, such contractor shall immediately notify the contracting agency.

**8. Reasonable Accommodation for Applicants / Employees with Disabilities:** The contractor must be familiar with the requirements for and comply with the Americans with Disabilities Act and all rules and regulations established thereunder. Employers must provide reasonable accommodation in all employment activities unless to do so would cause an undue hardship.

**9. Selection of Subcontractors, Procurement of Materials and Leasing of Equipment:** The contractor shall not discriminate on the grounds of race, color, religion, sex, sexual orientation, gender identity, national origin, age, or disability in the selection and retention of subcontractors, including procurement of materials and leases of equipment. The contractor shall take all necessary and reasonable steps to ensure nondiscrimination in the administration of this contract.

a. The contractor shall notify all potential subcontractors, suppliers, and lessors of their EEO obligations under this contract.

b. The contractor will use good faith efforts to ensure subcontractor compliance with their EEO obligations.

#### **10. Assurances Required:**

a. The requirements of 49 CFR Part 26 and the State DOT's FHWA-approved Disadvantaged Business Enterprise (DBE) program are incorporated by reference.

b. The contractor, subrecipient or subcontractor shall not discriminate on the basis of race, color, national origin, or sex in the performance of this contract. The contractor shall carry out applicable requirements of 49 CFR part 26 in the award and administration of DOT-assisted contracts. Failure by the contractor to carry out these requirements is a material breach of this contract, which may result in the termination of this contract or such other remedy as the recipient deems appropriate, which may include, but is not limited to:

- (1) Withholding monthly progress payments;
- (2) Assessing sanctions;
- (3) Liquidated damages; and/or
- (4) Disqualifying the contractor from future bidding as non-responsible.

c. The Title VI and nondiscrimination provisions of U.S. DOT Order 1050.2A at Appendixes A and E are incorporated by reference. 49 CFR Part 21.

**11. Records and Reports:** The contractor shall keep such records as necessary to document compliance with the EEO requirements. Such records shall be retained for a period of three years following the date of the final payment to the contractor for all contract work and shall be available at reasonable times and places for inspection by authorized representatives of the contracting agency and the FHWA.

a. The records kept by the contractor shall document the following:

(1) The number and work hours of minority and non-minority group members and women employed in each work classification on the project;

(2) The progress and efforts being made in cooperation with unions, when applicable, to increase employment opportunities for minorities and women; and

(3) The progress and efforts being made in locating, hiring, training, qualifying, and upgrading minorities and women.

b. The contractors and subcontractors will submit an annual report to the contracting agency each July for the duration of the project indicating the number of minority, women, and non-minority group employees currently engaged in each work classification required by the contract work. This information is to be reported on [Form FHWA-1391](#). The staffing data should represent the project work force on board in all or any part of the last payroll period preceding the end of July. If on-the-job training is being required by special provision, the contractor will be required to collect and report training data. The employment data should reflect the work force on board during all or any part of the last payroll period preceding the end of July.

### III. NONSEGREGATED FACILITIES

This provision is applicable to all Federal-aid construction contracts and to all related construction subcontracts of more than \$10,000. 41 CFR 60-1.5.

As prescribed by 41 CFR 60-1.8, the contractor must ensure that facilities provided for employees are provided in such a manner that segregation on the basis of race, color, religion, sex, sexual orientation, gender identity, or national origin cannot result. The contractor may neither require such segregated use by written or oral policies nor tolerate such use by employee custom. The contractor's obligation extends further to ensure that its employees are not assigned to perform their services at any location under the contractor's control where the facilities are segregated. The term "facilities" includes waiting rooms, work areas, restaurants and other eating areas, time clocks, restrooms, washrooms, locker rooms and other storage or dressing areas, parking lots, drinking fountains, recreation or entertainment areas, transportation, and housing provided for employees. The contractor shall provide separate or single-user restrooms and necessary dressing or sleeping areas to assure privacy between sexes.

### IV. DAVIS-BACON AND RELATED ACT PROVISIONS

This section is applicable to all Federal-aid construction projects exceeding \$2,000 and to all related subcontracts and lower-tier subcontracts (regardless of subcontract size), in accordance with 29 CFR 5.5. The requirements apply to all projects located within the right-of-way of a roadway that is functionally classified as Federal-aid highway. 23 U.S.C. 113. This excludes roadways functionally classified as local roads or rural minor collectors, which are exempt. 23 U.S.C. 101. Where applicable law requires that projects be treated as a project on a Federal-aid highway, the provisions of this subpart will apply regardless of the location of the project. Examples include: Surface Transportation Block Grant Program projects funded under 23 U.S.C. 133 [excluding recreational trails projects], the Nationally Significant Freight and Highway

Projects funded under 23 U.S.C. 117, and National Highway Freight Program projects funded under 23 U.S.C. 167.

The following provisions are from the U.S. Department of Labor regulations in 29 CFR 5.5 "Contract provisions and related matters" with minor revisions to conform to the FHWA-1273 format and FHWA program requirements.

#### 1. Minimum wages (29 CFR 5.5)

a. All laborers and mechanics employed or working upon the site of the work, will be paid unconditionally and not less often than once a week, and without subsequent deduction or rebate on any account (except such payroll deductions as are permitted by regulations issued by the Secretary of Labor under the Copeland Act (29 CFR part 3)), the full amount of wages and bona fide fringe benefits (or cash equivalents thereof) due at time of payment computed at rates not less than those contained in the wage determination of the Secretary of Labor which is attached hereto and made a part hereof, regardless of any contractual relationship which may be alleged to exist between the contractor and such laborers and mechanics.

Contributions made or costs reasonably anticipated for bona fide fringe benefits under section 1(b)(2) of the Davis-Bacon Act on behalf of laborers or mechanics are considered wages paid to such laborers or mechanics, subject to the provisions of paragraph 1.d. of this section; also, regular contributions made or costs incurred for more than a weekly period (but not less often than quarterly) under plans, funds, or programs which cover the particular weekly period, are deemed to be constructively made or incurred during such weekly period. Such laborers and mechanics shall be paid the appropriate wage rate and fringe benefits on the wage determination for the classification of work actually performed, without regard to skill, except as provided in 29 CFR 5.5(a)(4). Laborers or mechanics performing work in more than one classification may be compensated at the rate specified for each classification for the time actually worked therein: Provided, That the employer's payroll records accurately set forth the time spent in each classification in which work is performed. The wage determination (including any additional classification and wage rates conformed under paragraph 1.b. of this section) and the Davis-Bacon poster (WH-1321) shall be posted at all times by the contractor and its subcontractors at the site of the work in a prominent and accessible place where it can be easily seen by the workers.

b.(1) The contracting officer shall require that any class of laborers or mechanics, including helpers, which is not listed in the wage determination and which is to be employed under the contract shall be classified in conformance with the wage determination. The contracting officer shall approve an additional classification and wage rate and fringe benefits therefore only when the following criteria have been met:

(i) The work to be performed by the classification requested is not performed by a classification in the wage determination; and

(ii) The classification is utilized in the area by the construction industry; and

(iii) The proposed wage rate, including any bona fide fringe benefits, bears a reasonable relationship to the wage rates contained in the wage determination.

(2) If the contractor and the laborers and mechanics to be employed in the classification (if known), or their representatives, and the contracting officer agree on the classification and wage rate (including the amount designated for fringe benefits where appropriate), a report of the action taken shall be sent by the contracting officer to the Administrator of the Wage and Hour Division, U.S. Department of Labor, Washington, DC 20210. The Administrator, or an authorized representative, will approve, modify, or disapprove every additional classification action within 30 days of receipt and so advise the contracting officer or will notify the contracting officer within the 30-day period that additional time is necessary.

(3) In the event the contractor, the laborers or mechanics to be employed in the classification or their representatives, and the contracting officer do not agree on the proposed classification and wage rate (including the amount designated for fringe benefits, where appropriate), the contracting officer shall refer the questions, including the views of all interested parties and the recommendation of the contracting officer, to the Administrator for determination. The Administrator, or an authorized representative, will issue a determination within 30 days of receipt and so advise the contracting officer or will notify the contracting officer within the 30-day period that additional time is necessary.

(4) The wage rate (including fringe benefits where appropriate) determined pursuant to paragraphs 1.b.(2) or 1.b.(3) of this section, shall be paid to all workers performing work in the classification under this contract from the first day on which work is performed in the classification.

c. Whenever the minimum wage rate prescribed in the contract for a class of laborers or mechanics includes a fringe benefit which is not expressed as an hourly rate, the contractor shall either pay the benefit as stated in the wage determination or shall pay another bona fide fringe benefit or an hourly cash equivalent thereof.

d. If the contractor does not make payments to a trustee or other third person, the contractor may consider as part of the wages of any laborer or mechanic the amount of any costs reasonably anticipated in providing bona fide fringe benefits under a plan or program, Provided, That the Secretary of Labor has found, upon the written request of the contractor, that the applicable standards of the Davis-Bacon Act have been met. The Secretary of Labor may require the contractor to set aside in a separate account assets for the meeting of obligations under the plan or program.

## **2. Withholding (29 CFR 5.5)**

The contracting agency shall upon its own action or upon written request of an authorized representative of the Department of Labor, withhold or cause to be withheld from the contractor under this contract, or any other Federal contract with the same prime contractor, or any other federally-assisted contract subject to Davis-Bacon prevailing wage requirements, which is held by the same prime contractor, so much of the accrued payments or advances as may be considered necessary to pay laborers and mechanics,

including apprentices, trainees, and helpers, employed by the contractor or any subcontractor the full amount of wages required by the contract. In the event of failure to pay any laborer or mechanic, including any apprentice, trainee, or helper, employed or working on the site of the work, all or part of the wages required by the contract, the contracting agency may, after written notice to the contractor, take such action as may be necessary to cause the suspension of any further payment, advance, or guarantee of funds until such violations have ceased.

## **3. Payrolls and basic records (29 CFR 5.5)**

a. Payrolls and basic records relating thereto shall be maintained by the contractor during the course of the work and preserved for a period of three years thereafter for all laborers and mechanics working at the site of the work. Such records shall contain the name, address, and social security number of each such worker, his or her correct classification, hourly rates of wages paid (including rates of contributions or costs anticipated for bona fide fringe benefits or cash equivalents thereof of the types described in section 1(b)(2)(B) of the Davis-Bacon Act), daily and weekly number of hours worked, deductions made and actual wages paid. Whenever the Secretary of Labor has found under 29 CFR 5.5(a)(1)(iv) that the wages of any laborer or mechanic include the amount of any costs reasonably anticipated in providing benefits under a plan or program described in section 1(b)(2)(B) of the Davis-Bacon Act, the contractor shall maintain records which show that the commitment to provide such benefits is enforceable, that the plan or program is financially responsible, and that the plan or program has been communicated in writing to the laborers or mechanics affected, and records which show the costs anticipated or the actual cost incurred in providing such benefits. Contractors employing apprentices or trainees under approved programs shall maintain written evidence of the registration of apprenticeship programs and certification of trainee programs, the registration of the apprentices and trainees, and the ratios and wage rates prescribed in the applicable programs.

b.(1) The contractor shall submit weekly for each week in which any contract work is performed a copy of all payrolls to the contracting agency. The payrolls submitted shall set out accurately and completely all of the information required to be maintained under 29 CFR 5.5(a)(3)(i), except that full social security numbers and home addresses shall not be included on weekly transmittals. Instead the payrolls shall only need to include an individually identifying number for each employee (e.g., the last four digits of the employee's social security number). The required weekly payroll information may be submitted in any form desired. Optional Form WH-347 is available for this purpose from the Wage and Hour Division Web site. The prime contractor is responsible for the submission of copies of payrolls by all subcontractors. Contractors and subcontractors shall maintain the full social security number and current address of each covered worker, and shall provide them upon request to the contracting agency for transmission to the State DOT, the FHWA or the Wage and Hour Division of the Department of Labor for purposes of an investigation or audit of compliance with prevailing wage requirements. It is not a violation of this section for a prime contractor to require a subcontractor to provide addresses and social security numbers to the prime contractor for its own records, without weekly submission to the contracting agency.

(2) Each payroll submitted shall be accompanied by a "Statement of Compliance," signed by the contractor or

subcontractor or his or her agent who pays or supervises the payment of the persons employed under the contract and shall certify the following:

(i) That the payroll for the payroll period contains the information required to be provided under 29 CFR 5.5(a)(3)(ii), the appropriate information is being maintained under 29 CFR 5.5(a)(3)(i), and that such information is correct and complete;

(ii) That each laborer or mechanic (including each helper, apprentice, and trainee) employed on the contract during the payroll period has been paid the full weekly wages earned, without rebate, either directly or indirectly, and that no deductions have been made either directly or indirectly from the full wages earned, other than permissible deductions as set forth in 29 CFR part 3;

(iii) That each laborer or mechanic has been paid not less than the applicable wage rates and fringe benefits or cash equivalents for the classification of work performed, as specified in the applicable wage determination incorporated into the contract.

(3) The weekly submission of a properly executed certification set forth on the reverse side of Optional Form WH-347 shall satisfy the requirement for submission of the "Statement of Compliance" required by paragraph 3.b.(2) of this section.

(4) The falsification of any of the above certifications may subject the contractor or subcontractor to civil or criminal prosecution under 18 U.S.C. 1001 and 31 U.S.C. 231.

c. The contractor or subcontractor shall make the records required under paragraph 3.a. of this section available for inspection, copying, or transcription by authorized representatives of the contracting agency, the State DOT, the FHWA, or the Department of Labor, and shall permit such representatives to interview employees during working hours on the job. If the contractor or subcontractor fails to submit the required records or to make them available, the FHWA may, after written notice to the contractor, the contracting agency or the State DOT, take such action as may be necessary to cause the suspension of any further payment, advance, or guarantee of funds. Furthermore, failure to submit the required records upon request or to make such records available may be grounds for debarment action pursuant to 29 CFR 5.12.

#### 4. Apprentices and trainees (29 CFR 5.5)

##### a. Apprentices (programs of the USDOL).

Apprentices will be permitted to work at less than the predetermined rate for the work they performed when they are employed pursuant to and individually registered in a bona fide apprenticeship program registered with the U.S. Department of Labor, Employment and Training Administration, Office of Apprenticeship Training, Employer and Labor Services, or with a State Apprenticeship Agency recognized by the Office, or if a person is employed in his or her first 90 days of probationary employment as an apprentice in such an apprenticeship program, who is not individually registered in the program, but who has been certified by the Office of Apprenticeship Training, Employer and Labor Services or a State

Apprenticeship Agency (where appropriate) to be eligible for probationary employment as an apprentice.

The allowable ratio of apprentices to journeymen on the job site in any craft classification shall not be greater than the ratio permitted to the contractor as to the entire work force under the registered program. Any worker listed on a payroll at an apprentice wage rate, who is not registered or otherwise employed as stated above, shall be paid not less than the applicable wage rate on the wage determination for the classification of work actually performed. In addition, any apprentice performing work on the job site in excess of the ratio permitted under the registered program shall be paid not less than the applicable wage rate on the wage determination for the work actually performed. Where a contractor is performing construction on a project in a locality other than that in which its program is registered, the ratios and wage rates (expressed in percentages of the journeyman's hourly rate) specified in the contractor's or subcontractor's registered program shall be observed.

Every apprentice must be paid at not less than the rate specified in the registered program for the apprentice's level of progress, expressed as a percentage of the journeymen hourly rate specified in the applicable wage determination. Apprentices shall be paid fringe benefits in accordance with the provisions of the apprenticeship program. If the apprenticeship program does not specify fringe benefits, apprentices must be paid the full amount of fringe benefits listed on the wage determination for the applicable classification. If the Administrator determines that a different practice prevails for the applicable apprentice classification, fringes shall be paid in accordance with that determination.

In the event the Office of Apprenticeship Training, Employer and Labor Services, or a State Apprenticeship Agency recognized by the Office, withdraws approval of an apprenticeship program, the contractor will no longer be permitted to utilize apprentices at less than the applicable predetermined rate for the work performed until an acceptable program is approved.

##### b. Trainees (programs of the USDOL).

Except as provided in 29 CFR 5.16, trainees will not be permitted to work at less than the predetermined rate for the work performed unless they are employed pursuant to and individually registered in a program which has received prior approval, evidenced by formal certification by the U.S. Department of Labor, Employment and Training Administration.

The ratio of trainees to journeymen on the job site shall not be greater than permitted under the plan approved by the Employment and Training Administration.

Every trainee must be paid at not less than the rate specified in the approved program for the trainee's level of progress, expressed as a percentage of the journeyman hourly rate specified in the applicable wage determination. Trainees shall be paid fringe benefits in accordance with the provisions of the trainee program. If the trainee program does not mention fringe benefits, trainees shall be paid the full amount of fringe benefits listed on the wage determination unless the Administrator of the Wage and Hour Division determines that there is an apprenticeship program associated with the

corresponding journeyman wage rate on the wage determination which provides for less than full fringe benefits for apprentices. Any employee listed on the payroll at a trainee rate who is not registered and participating in a training plan approved by the Employment and Training Administration shall be paid not less than the applicable wage rate on the wage determination for the classification of work actually performed. In addition, any trainee performing work on the job site in excess of the ratio permitted under the registered program shall be paid not less than the applicable wage rate on the wage determination for the work actually performed.

In the event the Employment and Training Administration withdraws approval of a training program, the contractor will no longer be permitted to utilize trainees at less than the applicable predetermined rate for the work performed until an acceptable program is approved.

c. Equal employment opportunity. The utilization of apprentices, trainees and journeymen under this part shall be in conformity with the equal employment opportunity requirements of Executive Order 11246, as amended, and 29 CFR part 30.

d. Apprentices and Trainees (programs of the U.S. DOT).

Apprentices and trainees working under apprenticeship and skill training programs which have been certified by the Secretary of Transportation as promoting EEO in connection with Federal-aid highway construction programs are not subject to the requirements of paragraph 4 of this Section IV. 23 CFR 230.111(e)(2). The straight time hourly wage rates for apprentices and trainees under such programs will be established by the particular programs. The ratio of apprentices and trainees to journeymen shall not be greater than permitted by the terms of the particular program.

**5. Compliance with Copeland Act requirements.** The contractor shall comply with the requirements of 29 CFR part 3, which are incorporated by reference in this contract as provided in 29 CFR 5.5.

**6. Subcontracts.** The contractor or subcontractor shall insert Form FHWA-1273 in any subcontracts and also require the subcontractors to include Form FHWA-1273 in any lower tier subcontracts. The prime contractor shall be responsible for the compliance by any subcontractor or lower tier subcontractor with all the contract clauses in 29 CFR 5.5.

**7. Contract termination: debarment.** A breach of the contract clauses in 29 CFR 5.5 may be grounds for termination of the contract, and for debarment as a contractor and a subcontractor as provided in 29 CFR 5.12.

**8. Compliance with Davis-Bacon and Related Act requirements.** All rulings and interpretations of the Davis-Bacon and Related Acts contained in 29 CFR parts 1, 3, and 5 are herein incorporated by reference in this contract as provided in 29 CFR 5.5.

**9. Disputes concerning labor standards.** As provided in 29 CFR 5.5, disputes arising out of the labor standards provisions of this contract shall not be subject to the general disputes clause of this contract. Such disputes shall be resolved in accordance with the procedures of the Department of Labor

set forth in 29 CFR parts 5, 6, and 7. Disputes within the meaning of this clause include disputes between the contractor (or any of its subcontractors) and the contracting agency, the U.S. Department of Labor, or the employees or their representatives.

#### **10. Certification of eligibility (29 CFR 5.5)**

a. By entering into this contract, the contractor certifies that neither it (nor he or she) nor any person or firm who has an interest in the contractor's firm is a person or firm ineligible to be awarded Government contracts by virtue of section 3(a) of the Davis-Bacon Act or 29 CFR 5.12(a)(1).

b. No part of this contract shall be subcontracted to any person or firm ineligible for award of a Government contract by virtue of section 3(a) of the Davis-Bacon Act or 29 CFR 5.12(a)(1).

c. The penalty for making false statements is prescribed in the U.S. Criminal Code, 18 U.S.C. 1001.

#### **V. CONTRACT WORK HOURS AND SAFETY STANDARDS ACT**

Pursuant to 29 CFR 5.5(b), the following clauses apply to any Federal-aid construction contract in an amount in excess of \$100,000 and subject to the overtime provisions of the Contract Work Hours and Safety Standards Act. These clauses shall be inserted in addition to the clauses required by 29 CFR 5.5(a) or 29 CFR 4.6. As used in this paragraph, the terms laborers and mechanics include watchmen and guards.

**1. Overtime requirements.** No contractor or subcontractor contracting for any part of the contract work which may require or involve the employment of laborers or mechanics shall require or permit any such laborer or mechanic in any workweek in which he or she is employed on such work to work in excess of forty hours in such workweek unless such laborer or mechanic receives compensation at a rate not less than one and one-half times the basic rate of pay for all hours worked in excess of forty hours in such workweek. 29 CFR 5.5.

**2. Violation; liability for unpaid wages; liquidated damages.** In the event of any violation of the clause set forth in paragraph 1 of this section, the contractor and any subcontractor responsible therefor shall be liable for the unpaid wages. In addition, such contractor and subcontractor shall be liable to the United States (in the case of work done under contract for the District of Columbia or a territory, to such District or to such territory), for liquidated damages. Such liquidated damages shall be computed with respect to each individual laborer or mechanic, including watchmen and guards, employed in violation of the clause set forth in paragraph 1 of this section, in the sum currently provided in 29 CFR 5.5(b)(2)\* for each calendar day on which such individual was required or permitted to work in excess of the standard workweek of forty hours without payment of the overtime wages required by the clause set forth in paragraph 1 of this section. 29 CFR 5.5.

\* \$27 as of January 23, 2019 (See 84 FR 213-01, 218) as may be adjusted annually by the Department of Labor; pursuant to the Federal Civil Penalties Inflation Adjustment Act of 1990).

### **3. Withholding for unpaid wages and liquidated damages.**

The FHWA or the contracting agency shall upon its own action or upon written request of an authorized representative of the Department of Labor withhold or cause to be withheld, from any moneys payable on account of work performed by the contractor or subcontractor under any such contract or any other Federal contract with the same prime contractor, or any other federally-assisted contract subject to the Contract Work Hours and Safety Standards Act, which is held by the same prime contractor, such sums as may be determined to be necessary to satisfy any liabilities of such contractor or subcontractor for unpaid wages and liquidated damages as provided in the clause set forth in paragraph 2 of this section. 29 CFR 5.5.

**4. Subcontracts.** The contractor or subcontractor shall insert in any subcontracts the clauses set forth in paragraphs 1 through 4 of this section and also a clause requiring the subcontractors to include these clauses in any lower tier subcontracts. The prime contractor shall be responsible for compliance by any subcontractor or lower tier subcontractor with the clauses set forth in paragraphs 1 through 4 of this section. 29 CFR 5.5.

## **VI. SUBLETTING OR ASSIGNING THE CONTRACT**

This provision is applicable to all Federal-aid construction contracts on the National Highway System pursuant to 23 CFR 635.116.

1. The contractor shall perform with its own organization contract work amounting to not less than 30 percent (or a greater percentage if specified elsewhere in the contract) of the total original contract price, excluding any specialty items designated by the contracting agency. Specialty items may be performed by subcontract and the amount of any such specialty items performed may be deducted from the total original contract price before computing the amount of work required to be performed by the contractor's own organization (23 CFR 635.116).

a. The term "perform work with its own organization" in paragraph 1 of Section VI refers to workers employed or leased by the prime contractor, and equipment owned or rented by the prime contractor, with or without operators. Such term does not include employees or equipment of a subcontractor or lower tier subcontractor, agents of the prime contractor, or any other assignees. The term may include payments for the costs of hiring leased employees from an employee leasing firm meeting all relevant Federal and State regulatory requirements. Leased employees may only be included in this term if the prime contractor meets all of the following conditions: (based on longstanding interpretation)

- (1) the prime contractor maintains control over the supervision of the day-to-day activities of the leased employees;
- (2) the prime contractor remains responsible for the quality of the work of the leased employees;
- (3) the prime contractor retains all power to accept or exclude individual employees from work on the project; and
- (4) the prime contractor remains ultimately responsible for the payment of predetermined minimum wages, the submission of payrolls, statements of compliance and all other Federal regulatory requirements.

b. "Specialty Items" shall be construed to be limited to work that requires highly specialized knowledge, abilities, or

equipment not ordinarily available in the type of contracting organizations qualified and expected to bid or propose on the contract as a whole and in general are to be limited to minor components of the overall contract. 23 CFR 635.102.

2. Pursuant to 23 CFR 635.116(a), the contract amount upon which the requirements set forth in paragraph (1) of Section VI is computed includes the cost of material and manufactured products which are to be purchased or produced by the contractor under the contract provisions.

3. Pursuant to 23 CFR 635.116(c), the contractor shall furnish (a) a competent superintendent or supervisor who is employed by the firm, has full authority to direct performance of the work in accordance with the contract requirements, and is in charge of all construction operations (regardless of who performs the work) and (b) such other of its own organizational resources (supervision, management, and engineering services) as the contracting officer determines is necessary to assure the performance of the contract.

4. No portion of the contract shall be sublet, assigned or otherwise disposed of except with the written consent of the contracting officer, or authorized representative, and such consent when given shall not be construed to relieve the contractor of any responsibility for the fulfillment of the contract. Written consent will be given only after the contracting agency has assured that each subcontract is evidenced in writing and that it contains all pertinent provisions and requirements of the prime contract. (based on longstanding interpretation of 23 CFR 635.116).

5. The 30-percent self-performance requirement of paragraph (1) is not applicable to design-build contracts; however, contracting agencies may establish their own self-performance requirements. 23 CFR 635.116(d).

## **VII. SAFETY: ACCIDENT PREVENTION**

This provision is applicable to all Federal-aid construction contracts and to all related subcontracts.

1. In the performance of this contract the contractor shall comply with all applicable Federal, State, and local laws governing safety, health, and sanitation (23 CFR Part 635). The contractor shall provide all safeguards, safety devices and protective equipment and take any other needed actions as it determines, or as the contracting officer may determine, to be reasonably necessary to protect the life and health of employees on the job and the safety of the public and to protect property in connection with the performance of the work covered by the contract. 23 CFR 635.108.

2. It is a condition of this contract, and shall be made a condition of each subcontract, which the contractor enters into pursuant to this contract, that the contractor and any subcontractor shall not permit any employee, in performance of the contract, to work in surroundings or under conditions which are unsanitary, hazardous or dangerous to his/her health or safety, as determined under construction safety and health standards (29 CFR Part 1926) promulgated by the Secretary of Labor, in accordance with Section 107 of the Contract Work Hours and Safety Standards Act (40 U.S.C. 3704). 29 CFR 1926.10.

3. Pursuant to 29 CFR 1926.3, it is a condition of this contract that the Secretary of Labor or authorized representative thereof, shall have right of entry to any site of contract performance to inspect or investigate the matter of compliance

with the construction safety and health standards and to carry out the duties of the Secretary under Section 107 of the Contract Work Hours and Safety Standards Act (40 U.S.C. 3704).

### **VIII. FALSE STATEMENTS CONCERNING HIGHWAY PROJECTS**

This provision is applicable to all Federal-aid construction contracts and to all related subcontracts.

In order to assure high quality and durable construction in conformity with approved plans and specifications and a high degree of reliability on statements and representations made by engineers, contractors, suppliers, and workers on Federal-aid highway projects, it is essential that all persons concerned with the project perform their functions as carefully, thoroughly, and honestly as possible. Willful falsification, distortion, or misrepresentation with respect to any facts related to the project is a violation of Federal law. To prevent any misunderstanding regarding the seriousness of these and similar acts, Form FHWA-1022 shall be posted on each Federal-aid highway project (23 CFR Part 635) in one or more places where it is readily available to all persons concerned with the project:

18 U.S.C. 1020 reads as follows:

"Whoever, being an officer, agent, or employee of the United States, or of any State or Territory, or whoever, whether a person, association, firm, or corporation, knowingly makes any false statement, false representation, or false report as to the character, quality, quantity, or cost of the material used or to be used, or the quantity or quality of the work performed or to be performed, or the cost thereof in connection with the submission of plans, maps, specifications, contracts, or costs of construction on any highway or related project submitted for approval to the Secretary of Transportation; or

Whoever knowingly makes any false statement, false representation, false report or false claim with respect to the character, quality, quantity, or cost of any work performed or to be performed, or materials furnished or to be furnished, in connection with the construction of any highway or related project approved by the Secretary of Transportation; or

Whoever knowingly makes any false statement or false representation as to material fact in any statement, certificate, or report submitted pursuant to provisions of the Federal-aid Roads Act approved July 11, 1916, (39 Stat. 355), as amended and supplemented;

Shall be fined under this title or imprisoned not more than 5 years or both."

### **IX. IMPLEMENTATION OF CLEAN AIR ACT AND FEDERAL WATER POLLUTION CONTROL ACT (42 U.S.C. 7606; 2 CFR 200.88; EO 11738)**

This provision is applicable to all Federal-aid construction contracts in excess of \$150,000 and to all related subcontracts. 48 CFR 2.101; 2 CFR 200.326.

By submission of this bid/proposal or the execution of this contract or subcontract, as appropriate, the bidder, proposer, Federal-aid construction contractor, subcontractor, supplier, or vendor agrees to comply with all applicable standards, orders

or regulations issued pursuant to the Clean Air Act (42 U.S.C. 7401-7671q) and the Federal Water Pollution Control Act, as amended (33 U.S.C. 1251-1387). Violations must be reported to the Federal Highway Administration and the Regional Office of the Environmental Protection Agency. 2 CFR Part 200, Appendix II.

The contractor agrees to include or cause to be included the requirements of this Section in every subcontract, and further agrees to take such action as the contracting agency may direct as a means of enforcing such requirements. 2 CFR 200.326.

### **X. CERTIFICATION REGARDING DEBARMENT, SUSPENSION, INELIGIBILITY AND VOLUNTARY EXCLUSION**

This provision is applicable to all Federal-aid construction contracts, design-build contracts, subcontracts, lower-tier subcontracts, purchase orders, lease agreements, consultant contracts or any other covered transaction requiring FHWA approval or that is estimated to cost \$25,000 or more – as defined in 2 CFR Parts 180 and 1200. 2 CFR 180.220 and 1200.220.

#### **1. Instructions for Certification – First Tier Participants:**

a. By signing and submitting this proposal, the prospective first tier participant is providing the certification set out below.

b. The inability of a person to provide the certification set out below will not necessarily result in denial of participation in this covered transaction. The prospective first tier participant shall submit an explanation of why it cannot provide the certification set out below. The certification or explanation will be considered in connection with the department or agency's determination whether to enter into this transaction. However, failure of the prospective first tier participant to furnish a certification or an explanation shall disqualify such a person from participation in this transaction. 2 CFR 180.320.

c. The certification in this clause is a material representation of fact upon which reliance was placed when the contracting agency determined to enter into this transaction. If it is later determined that the prospective participant knowingly rendered an erroneous certification, in addition to other remedies available to the Federal Government, the contracting agency may terminate this transaction for cause of default. 2 CFR 180.325.

d. The prospective first tier participant shall provide immediate written notice to the contracting agency to whom this proposal is submitted if any time the prospective first tier participant learns that its certification was erroneous when submitted or has become erroneous by reason of changed circumstances. 2 CFR 180.345 and 180.350.

e. The terms "covered transaction," "debarred," "suspended," "ineligible," "participant," "person," "principal," and "voluntarily excluded," as used in this clause, are defined in 2 CFR Parts 180, Subpart I, 180.900-180.1020, and 1200. "First Tier Covered Transactions" refers to any covered transaction between a recipient or subrecipient of Federal funds and a participant (such as the prime or general contract). "Lower Tier Covered Transactions" refers to any covered transaction under a First Tier Covered Transaction (such as subcontracts). "First Tier Participant" refers to the participant



who has entered into a covered transaction with a recipient or subrecipient of Federal funds (such as the prime or general contractor). "Lower Tier Participant" refers any participant who has entered into a covered transaction with a First Tier Participant or other Lower Tier Participants (such as subcontractors and suppliers).

f. The prospective first tier participant agrees by submitting this proposal that, should the proposed covered transaction be entered into, it shall not knowingly enter into any lower tier covered transaction with a person who is debarred, suspended, declared ineligible, or voluntarily excluded from participation in this covered transaction, unless authorized by the department or agency entering into this transaction. 2 CFR 180.330.

g. The prospective first tier participant further agrees by submitting this proposal that it will include the clause titled "Certification Regarding Debarment, Suspension, Ineligibility and Voluntary Exclusion-Lower Tier Covered Transactions," provided by the department or contracting agency, entering into this covered transaction, without modification, in all lower tier covered transactions and in all solicitations for lower tier covered transactions exceeding the \$25,000 threshold. 2 CFR 180.220 and 180.300.

h. A participant in a covered transaction may rely upon a certification of a prospective participant in a lower tier covered transaction that is not debarred, suspended, ineligible, or voluntarily excluded from the covered transaction, unless it knows that the certification is erroneous. 2 CFR 180.300; 180.320, and 180.325. A participant is responsible for ensuring that its principals are not suspended, debarred, or otherwise ineligible to participate in covered transactions. 2 CFR 180.335. To verify the eligibility of its principals, as well as the eligibility of any lower tier prospective participants, each participant may, but is not required to, check the System for Award Management website (<https://www.sam.gov/>). 2 CFR 180.300, 180.320, and 180.325.

i. Nothing contained in the foregoing shall be construed to require the establishment of a system of records in order to render in good faith the certification required by this clause. The knowledge and information of the prospective participant is not required to exceed that which is normally possessed by a prudent person in the ordinary course of business dealings.

j. Except for transactions authorized under paragraph (f) of these instructions, if a participant in a covered transaction knowingly enters into a lower tier covered transaction with a person who is suspended, debarred, ineligible, or voluntarily excluded from participation in this transaction, in addition to other remedies available to the Federal Government, the department or agency may terminate this transaction for cause or default. 2 CFR 180.325.

\* \* \* \* \*

## **2. Certification Regarding Debarment, Suspension, Ineligibility and Voluntary Exclusion – First Tier Participants:**

a. The prospective first tier participant certifies to the best of its knowledge and belief, that it and its principals:

(1) Are not presently debarred, suspended, proposed for debarment, declared ineligible, or voluntarily excluded from participating in covered transactions by any Federal department or agency, 2 CFR 180.335;.

(2) Have not within a three-year period preceding this proposal been convicted of or had a civil judgment rendered against them for commission of fraud or a criminal offense in connection with obtaining, attempting to obtain, or performing a public (Federal, State, or local) transaction or contract under a public transaction; violation of Federal or State antitrust statutes or commission of embezzlement, theft, forgery, bribery, falsification or destruction of records, making false statements, or receiving stolen property, 2 CFR 180.800;

(3) Are not presently indicted for or otherwise criminally or civilly charged by a governmental entity (Federal, State or local) with commission of any of the offenses enumerated in paragraph (a)(2) of this certification, 2 CFR 180.700 and 180.800; and

(4) Have not within a three-year period preceding this application/proposal had one or more public transactions (Federal, State or local) terminated for cause or default. 2 CFR 180.335(d).

(5) Are not a corporation that has been convicted of a felony violation under any Federal law within the two-year period preceding this proposal (USDOT Order 4200.6 implementing appropriations act requirements); and

(6) Are not a corporation with any unpaid Federal tax liability that has been assessed, for which all judicial and administrative remedies have been exhausted, or have lapsed, and that is not being paid in a timely manner pursuant to an agreement with the authority responsible for collecting the tax liability (USDOT Order 4200.6 implementing appropriations act requirements).

b. Where the prospective participant is unable to certify to any of the statements in this certification, such prospective participant should attach an explanation to this proposal. 2 CFR 180.335 and 180.340.

## **3. Instructions for Certification - Lower Tier Participants:**

(Applicable to all subcontracts, purchase orders, and other lower tier transactions requiring prior FHWA approval or estimated to cost \$25,000 or more - 2 CFR Parts 180 and 1200). 2 CFR 180.220 and 1200.220.

a. By signing and submitting this proposal, the prospective lower tier participant is providing the certification set out below.

b. The certification in this clause is a material representation of fact upon which reliance was placed when this transaction was entered into. If it is later determined that the prospective lower tier participant knowingly rendered an erroneous certification, in addition to other remedies available to the Federal Government, the department, or agency with which this transaction originated may pursue available remedies, including suspension and/or debarment.

c. The prospective lower tier participant shall provide immediate written notice to the person to which this proposal is submitted if at any time the prospective lower tier participant learns that its certification was erroneous by reason of changed circumstances. 2 CFR 180.365.

d. The terms "covered transaction," "debarred," "suspended," "ineligible," "participant," "person," "principal," and "voluntarily excluded," as used in this clause, are defined in 2 CFR Parts 180, Subpart I, 180.900 – 180.1020, and 1200. You may contact the person to which this proposal is



submitted for assistance in obtaining a copy of those regulations. "First Tier Covered Transactions" refers to any covered transaction between a recipient or subrecipient of Federal funds and a participant (such as the prime or general contractor). "Lower Tier Covered Transactions" refers to any covered transaction under a First Tier Covered Transaction (such as subcontracts). "First Tier Participant" refers to the participant who has entered into a covered transaction with a recipient or subrecipient of Federal funds (such as the prime or general contractor). "Lower Tier Participant" refers any participant who has entered into a covered transaction with a First Tier Participant or other Lower Tier Participants (such as subcontractors and suppliers).

e. The prospective lower tier participant agrees by submitting this proposal that, should the proposed covered transaction be entered into, it shall not knowingly enter into any lower tier covered transaction with a person who is debarred, suspended, declared ineligible, or voluntarily excluded from participation in this covered transaction, unless authorized by the department or agency with which this transaction originated. 2 CFR 1200.220 and 1200.332.

f. The prospective lower tier participant further agrees by submitting this proposal that it will include this clause titled "Certification Regarding Debarment, Suspension, Ineligibility and Voluntary Exclusion-Lower Tier Covered Transaction," without modification, in all lower tier covered transactions and in all solicitations for lower tier covered transactions exceeding the \$25,000 threshold. 2 CFR 180.220 and 1200.220.

g. A participant in a covered transaction may rely upon a certification of a prospective participant in a lower tier covered transaction that is not debarred, suspended, ineligible, or voluntarily excluded from the covered transaction, unless it knows that the certification is erroneous. A participant is responsible for ensuring that its principals are not suspended, debarred, or otherwise ineligible to participate in covered transactions. To verify the eligibility of its principals, as well as the eligibility of any lower tier prospective participants, each participant may, but is not required to, check the System for Award Management website (<https://www.sam.gov/>), which is compiled by the General Services Administration. 2 CFR 180.300, 180.320, 180.330, and 180.335.

h. Nothing contained in the foregoing shall be construed to require establishment of a system of records in order to render in good faith the certification required by this clause. The knowledge and information of participant is not required to exceed that which is normally possessed by a prudent person in the ordinary course of business dealings.

i. Except for transactions authorized under paragraph e of these instructions, if a participant in a covered transaction knowingly enters into a lower tier covered transaction with a person who is suspended, debarred, ineligible, or voluntarily excluded from participation in this transaction, in addition to other remedies available to the Federal Government, the department or agency with which this transaction originated may pursue available remedies, including suspension and/or debarment. 2 CFR 180.325.

\*\*\*\*\*

**Certification Regarding Debarment, Suspension, Ineligibility and Voluntary Exclusion--Lower Tier Participants:**

1. The prospective lower tier participant certifies, by submission of this proposal, that neither it nor its principals:

(a) is presently debarred, suspended, proposed for debarment, declared ineligible, or voluntarily excluded from participating in covered transactions by any Federal department or agency, 2 CFR 180.355;

(b) is a corporation that has been convicted of a felony violation under any Federal law within the two-year period preceding this proposal (USDOT Order 4200.6 implementing appropriations act requirements); and

(c) is a corporation with any unpaid Federal tax liability that has been assessed, for which all judicial and administrative remedies have been exhausted, or have lapsed, and that is not being paid in a timely manner pursuant to an agreement with the authority responsible for collecting the tax liability. (USDOT Order 4200.6 implementing appropriations act requirements)

2. Where the prospective lower tier participant is unable to certify to any of the statements in this certification, such prospective participant should attach an explanation to this proposal.

\*\*\*\*\*

**XI. CERTIFICATION REGARDING USE OF CONTRACT FUNDS FOR LOBBYING**

This provision is applicable to all Federal-aid construction contracts and to all related subcontracts which exceed \$100,000. 49 CFR Part 20, App. A.

1. The prospective participant certifies, by signing and submitting this bid or proposal, to the best of his or her knowledge and belief, that:

a. No Federal appropriated funds have been paid or will be paid, by or on behalf of the undersigned, to any person for influencing or attempting to influence an officer or employee of any Federal agency, a Member of Congress, an officer or employee of Congress, or an employee of a Member of Congress in connection with the awarding of any Federal contract, the making of any Federal grant, the making of any Federal loan, the entering into of any cooperative agreement, and the extension, continuation, renewal, amendment, or modification of any Federal contract, grant, loan, or cooperative agreement.

b. If any funds other than Federal appropriated funds have been paid or will be paid to any person for influencing or attempting to influence an officer or employee of any Federal agency, a Member of Congress, an officer or employee of Congress, or an employee of a Member of Congress in connection with this Federal contract, grant, loan, or cooperative agreement, the undersigned shall complete and submit Standard Form-LLL, "Disclosure Form to Report Lobbying," in accordance with its instructions.

2. This certification is a material representation of fact upon which reliance was placed when this transaction was made or entered into. Submission of this certification is a prerequisite for making or entering into this transaction imposed by 31 U.S.C. 1352. Any person who fails to file the required certification shall be subject to a civil penalty of not less than \$10,000 and not more than \$100,000 for each such failure.

3. The prospective participant also agrees by submitting its bid or proposal that the participant shall require that the language of this certification be included in all lower tier

subcontracts, which exceed \$100,000 and that all such recipients shall certify and disclose accordingly.

## **XII. USE OF UNITED STATES-FLAG VESSELS:**

This provision is applicable to all Federal-aid construction contracts, design-build contracts, subcontracts, lower-tier subcontracts, purchase orders, lease agreements, or any other covered transaction. 46 CFR Part 381.

This requirement applies to material or equipment that is acquired for a specific Federal-aid highway project. 46 CFR 381.7. It is not applicable to goods or materials that come into inventories independent of an FHWA funded-contract.

When oceanic shipments (or shipments across the Great Lakes) are necessary for materials or equipment acquired for a specific Federal-aid construction project, the bidder, proposer, contractor, subcontractor, or vendor agrees:

1. To utilize privately owned United States-flag commercial vessels to ship at least 50 percent of the gross tonnage (computed separately for dry bulk carriers, dry cargo liners, and tankers) involved, whenever shipping any equipment, material, or commodities pursuant to this contract, to the extent such vessels are available at fair and reasonable rates for United States-flag commercial vessels. 46 CFR 381.7.
2. To furnish within 20 days following the date of loading for shipments originating within the United States or within 30 working days following the date of loading for shipments originating outside the United States, a legible copy of a rated, 'on-board' commercial ocean bill-of-lading in English for each shipment of cargo described in paragraph (b)(1) of this section to both the Contracting Officer (through the prime contractor in the case of subcontractor bills-of-lading) and to the Office of Cargo and Commercial Sealift (MAR-620), Maritime Administration, Washington, DC 20590. (MARAD requires copies of the ocean carrier's (master) bills of lading, certified onboard, dated, with rates and charges. These bills of lading may contain business sensitive information and therefore may be submitted directly to MARAD by the Ocean Transportation Intermediary on behalf of the contractor). 46 CFR 381.7.

**ATTACHMENT A - EMPLOYMENT AND MATERIALS  
PREFERENCE FOR APPALACHIAN DEVELOPMENT  
HIGHWAY SYSTEM OR APPALACHIAN LOCAL ACCESS  
ROAD CONTRACTS (23 CFR 633, Subpart B, Appendix B)**

This provision is applicable to all Federal-aid projects funded under the Appalachian Regional Development Act of 1965.

1. During the performance of this contract, the contractor undertaking to do work which is, or reasonably may be, done as on-site work, shall give preference to qualified persons who regularly reside in the labor area as designated by the DOL wherein the contract work is situated, or the subregion, or the Appalachian counties of the State wherein the contract work is situated, except:

a. To the extent that qualified persons regularly residing in the area are not available.

b. For the reasonable needs of the contractor to employ supervisory or specially experienced personnel necessary to assure an efficient execution of the contract work.

c. For the obligation of the contractor to offer employment to present or former employees as the result of a lawful collective bargaining contract, provided that the number of nonresident persons employed under this subparagraph (1c) shall not exceed 20 percent of the total number of employees employed by the contractor on the contract work, except as provided in subparagraph (4) below.

2. The contractor shall place a job order with the State Employment Service indicating (a) the classifications of the laborers, mechanics and other employees required to perform the contract work, (b) the number of employees required in each classification, (c) the date on which the participant estimates such employees will be required, and (d) any other pertinent information required by the State Employment Service to complete the job order form. The job order may be placed with the State Employment Service in writing or by telephone. If during the course of the contract work, the information submitted by the contractor in the original job order is substantially modified, the participant shall promptly notify the State Employment Service.

3. The contractor shall give full consideration to all qualified job applicants referred to him by the State Employment Service. The contractor is not required to grant employment to any job applicants who, in his opinion, are not qualified to perform the classification of work required.

4. If, within one week following the placing of a job order by the contractor with the State Employment Service, the State Employment Service is unable to refer any qualified job applicants to the contractor, or less than the number requested, the State Employment Service will forward a certificate to the contractor indicating the unavailability of applicants. Such certificate shall be made a part of the contractor's permanent project records. Upon receipt of this certificate, the contractor may employ persons who do not normally reside in the labor area to fill positions covered by the certificate, notwithstanding the provisions of subparagraph (1c) above.

5. The provisions of 23 CFR 633.207(e) allow the contracting agency to provide a contractual preference for the use of mineral resource materials native to the Appalachian region.

6. The contractor shall include the provisions of Sections 1 through 4 of this Attachment A in every subcontract for work which is, or reasonably may be, done as on-site work.

## **Non-discrimination Provisions**

**During the performance of this contract, the contractor, for itself, its assignees, and successors in interest (hereinafter referred to as the "contractor") agrees as follows:**

**1. Compliance with Regulations:** The contractor (hereinafter includes consultants) will comply with the Acts and the Regulations relative to Non-discrimination in Federally-assisted programs of the U.S. Department of Transportation, Federal Highway Administration, as they may be amended from time to time, which are herein incorporated by reference and made a part of this contract.

**2. Non-discrimination:** The contractor, with regard to the work performed by it during the contract, will not discriminate on the grounds of race, color, or national origin in the selection and retention of subcontractors, including procurements of materials and leases of equipment. The contractor will not participate directly or indirectly in the discrimination prohibited by the Acts and the Regulations, including employment practices when the contract covers any activity, project, or program set forth in Appendix B of 49 CFR Part 21.

**3. Solicitations for Subcontracts, Including Procurements of Materials and Equipment:** In all solicitations, either by competitive bidding, or negotiation made by the contractor for work to be performed under a subcontract, including procurements of materials, or leases of equipment, each potential subcontractor or supplier will be notified by the contractor of the contractor's obligations under this contract and the Acts and the Regulations relative to Non-discrimination on the grounds of race, color, or national origin.

**4. Information and Reports:** The contractor will provide all information and reports required by the Acts, the Regulations, and directives issued pursuant thereto and will permit access to its books, records, accounts, other sources of information, and its facilities as may be determined by the Recipient or the Federal Highway Administration to be pertinent to ascertain compliance with such Acts, Regulations, and instructions. Where any information required of a contractor is in the exclusive possession of another who fails or refuses to furnish the information, the contractor will so certify to the Recipient or the Federal Highway Administration, as appropriate, and will set forth what efforts it has made to obtain the information.

**5. Sanctions for Noncompliance:** In the event of a contractor's noncompliance with the Non-discrimination provisions of this contract, the Recipient will impose such contract sanctions as it or the Federal Highway Administration may determine to be appropriate, including, but not limited to:

- a. Withholding payments to the contractor under the contract until the contractor complies; and/or
- b. Cancelling, terminating, or suspending a contract, in whole or in part.

**6. Incorporation of Provisions:** The contractor will include the provisions of paragraphs one through six in every subcontract, including procurements of materials and leases of equipment, unless exempt by the Acts, the Regulations and directives issued pursuant thereto. The contractor will take action with respect to any subcontract or procurement as the Recipient or the Federal Highway Administration may direct as a means of enforcing such provisions including sanctions for noncompliance. Provided, that if the contractor becomes involved in, or is threatened with litigation by a subcontractor, or supplier because of such direction, the contractor may request the Recipient to enter into any litigation to protect the interests of the Recipient. In addition, the contractor may request the United States to enter into the litigation to protect the interests of the United States.

**During the performance of this contract, the contractor, for itself, its assignees, and successors in interest (hereinafter referred to as the "contractor") agrees to comply with the following non-discrimination statutes and authorities; including but not limited to:**

**Pertinent Non-Discrimination Authorities:**

- Title VI of the Civil Rights Act of 1964 (42 U.S.C. § 2000d et seq., 78 stat. 252), (prohibits discrimination on the basis of race, color, national origin); and 49 CFR Part 21.
- The Uniform Relocation Assistance and Real Property Acquisition Policies Act of 1970, (42 U.S.C. § 4601), (prohibits unfair treatment of persons displaced or whose property has been acquired because of Federal or Federal-aid programs and projects);
- Federal-Aid Highway Act of 1973, (23 U.S.C. § 324 et seq.), (prohibits discrimination on the basis of sex);
- Section 504 of the Rehabilitation Act of 1973, (29 U.S.C. § 794 et seq.), as amended, (prohibits discrimination on the basis of disability); and 49 CFR Part 27;
- The Age Discrimination Act of 1975, as amended, (42 U.S.C. § 6101 et seq.), (prohibits discrimination on the basis of age);
- Airport and Airway Improvement Act of 1982, (49 USC § 471, Section 47123), as amended, (prohibits discrimination based on race, creed, color, national origin, or sex);
- The Civil Rights Restoration Act of 1987, (PL 100-209), (Broadened the scope, coverage and applicability of Title VI of the Civil Rights Act of 1964, The Age Discrimination Act of 1975 and Section 504 of the Rehabilitation Act of 1973, by expanding the definition of the terms "programs or activities" to include all of the programs or activities of the Federal-aid recipients, sub-recipients and contractors, whether such programs or activities are Federally funded or not);
- Titles II and III of the Americans with Disabilities Act, which prohibit discrimination on the basis of disability in the operation of public entities, public and private transportation systems, places of public accommodation, and certain testing entities (42 U.S.C. §§ 12131-12189) as implemented by Department of Transportation regulations at 49 C.F.R. parts 37 and 38;
- The Federal Aviation Administration's Non-discrimination statute (49 U.S.C. § 47123) (prohibits discrimination on the basis of race, color, national origin, and sex);

- Executive Order 12898, Federal Actions to Address Environmental Justice in Minority Populations and Low-Income Populations, which ensures Non-discrimination against minority populations by discouraging programs, policies, and activities with disproportionately high and adverse human health or environmental effects on minority and low-income populations;
- Executive Order 13166, Improving Access to Services for Persons with Limited English Proficiency, and resulting agency guidance, national origin discrimination includes discrimination because of Limited English proficiency (LEP). To ensure compliance with Title VI, you must take reasonable steps to ensure that LEP persons have meaningful access to your programs (70 Fed. Reg. at 74087 to 74100);
- Title IX of the Education Amendments of 1972, as amended, which prohibits you from discriminating because of sex in education programs or activities (20 U.S.C. 1681 et seq).

**SEPTEMBER 2002**

**NOTICE OF REQUIREMENT FOR AFFIRMATIVE ACTION TO ENSURE  
EQUAL EMPLOYMENT OPPORTUNITY (EXECUTIVE ORDER 11246)**

1. The Offeror's or Bidder's attention is called to the "Employment Practices" and "Equal Opportunity Clause" set forth in the Required Contract Provisions, FHWA 1273.
2. The goals and timetables for minority and female participation expressed in percentage terms for the contractor's aggregate work force in each trade, on all construction work in the covered area, are as follows:

**Goals for Minority Participation for Each Trade:**

<u>County</u>	<u>%</u>	<u>County</u>	<u>%</u>	<u>County</u>	<u>%</u>
Adams	1.7	Iowa	1.7	Polk	2.2
Ashland	1.2	Iron	1.2	Portage	0.6
Barron	0.6	Jackson	0.6	Price	0.6
Bayfield	1.2	Jefferson	7.0	Racine	8.4
Brown	1.3	Juneau	0.6	Richland	1.7
Buffalo	0.6	Kenosha	3.0	Rock	3.1
Burnett	2.2	Kewaunee	1.0	Rusk	0.6
Calumet	0.9	La Crosse	0.9	St. Croix	2.9
Chippewa	0.5	Lafayette	0.5	Sauk	1.7
Clark	0.6	Langlade	0.6	Sawyer	0.6
Columbia	1.7	Lincoln	0.6	Shawano	1.0
Crawford	0.5	Manitowoc	1.0	Sheboygan	7.0
Dane	2.2	Marathon	0.6	Taylor	0.6
Dodge	7.0	Marinette	1.0	Trempealeau	0.6
Door	1.0	Marquette	1.7	Vernon	0.6
Douglas	1.0	Menominee	1.0	Vilas	0.6
Dunn	0.6	Milwaukee	8.0	Walworth	7.0
Eau Claire	0.5	Monroe	0.6	Washburn	0.6
Florence	1.0	Oconto	1.0	Washington	8.0
Fond du Lac	1.0	Oneida	0.6	Waukesha	8.0
Forest	1.0	Outagamie	0.9	Waupaca	1.0
Grant	0.5	Ozaukee	8.0	Waushara	1.0
Green	1.7	Pepin	0.6	Winnebago	0.9
Green Lake	1.0	Pierce	2.2	Wood	0.6

**Goals for female participation for each trade: 6.9%**

These goals are applicable to all the contractor's construction work, (whether or not it is federal or federally assisted), performed in the covered area. If the contractor performs construction work in the geographical area located outside of the covered area, it shall apply the goals established for such geographical area where the work is actually performed. With regard to this second area, the contractor also is subject to the goals for both its federally involved and nonfederally involved construction.

The contractor's compliance with the Executive Order and the Regulations in 41 CFR Part 60-4 shall be based on its implementation of the Equal Opportunity Clause, specific affirmative action obligations required by the specifications set forth in 41 CFR 60-4.3(a), and its efforts to meet the goals. The hours of minority and female employment and training must be substantially uniform throughout the length of the contract, and in each trade, and the contractor shall make a good faith effort to employ minorities and women evenly on each of its projects. The transfer of minority or female employees or trainees from contractor to contractor or from project to project for the sole purpose of meeting the contractor's goals shall be a violation of the contract, the Executive Order and the Regulations in 41 CFR Part 60-4. Compliance with the goals will be measured against the total work hours performed.

3. The contractor shall provide written notification to the Director of the Office of Federal Contract Compliance Programs within ten (10) working days of award of any construction subcontract in excess of \$10,000.00 at any tier for construction work under the contract resulting from this solicitation. The notification shall list the name, address and telephone number of the subcontractor, employer identification number of the subcontractor; estimated dollar amount of the subcontract; estimated starting and completion dates of the subcontract; and the geographical area in which the subcontract is to be performed.

As referred to in this section, the Director means:

Director  
Office of Federal Contract Compliance Programs  
Ruess Federal Plaza  
310 W. Wisconsin Ave., Suite 1115  
Milwaukee, WI 53202

The "Employer Identification Number" means the Federal Social Security number used on the Employer's Quarterly Federal Tax Return, U.S. Treasury Department Form 941.

4. As used in this notice, and in the contract resulting from solicitation, the "covered area" is the county(ies) in Wisconsin to which this proposal applies.



**APRIL 2013**

**ADDITIONAL FEDERAL-AID PROVISIONS**

**NOTICE TO ALL BIDDERS**

To report bid rigging activities call:

**1-800-424-9071**

The U.S. Department of Transportation (DOT) operates the above toll-free "hotline" Monday through Friday, 8:00 a.m. to 5:00 p.m., Eastern Time. Anyone with knowledge of possible bid rigging, bidding collusion, or other fraudulent activities should use the "hotline" to report such activities.

The "hotline" is part of the DOT's continuing effort to identify and investigate highway construction contract fraud and abuse and is operated under the direction of the DOT Inspector General. All information will be treated confidentially and caller anonymity will be respected.

**Effective November 2020 letting**

### **BUY AMERICA PROVISION**

All steel and iron materials permanently incorporated in this project shall be domestic products and all manufacturing and coating processes for these materials from smelting forward in the manufacturing process must have occurred within the United States. Coating includes epoxy coating, galvanizing, painting and any other coating that protects or enhances the value of a material subject to the requirements of Buy America. The exemption of this requirement is the minimal use of foreign materials if the total cost of such material permanently incorporated in the product does not exceed one-tenth of one percent (1/10 of 1%) of the total contract cost or \$2,500.00, whichever is greater. For purposes of this paragraph, the cost is that shown to be the value of the subject products as they are delivered to the project. The contractor shall take actions and provide documentation conforming to CMM 2-28.5 to ensure compliance with this "Buy America" provision.

<https://wisconsindot.gov/rdwy/cmm/cm-02-28.pdf>

Upon completion of the project certify to the engineer, in writing using department form DT4567, that all steel, iron, and coating processes for steel or iron incorporated into the contract work conform to these "Buy America" provisions. Attach a list of exemptions and their associated costs to the certification form. Department form DT4567 is available at:

<https://wisconsindot.gov/Documents/formdocs/dt4567.docx>

## Cargo Preference Act Requirement

All Federal-aid projects shall comply with 46 CFR 381.7 (a) – (b) as follows:

(a) *Agreement Clauses*. "Use of United States-flag vessels:"

(1) Pursuant to Pub. L. 664 (43 U.S.C. 1241(b)) at least 50 percent of any equipment, materials or commodities procured, contracted for or otherwise obtained with funds granted, guaranteed, loaned, or advanced by the U.S. Government under this agreement, and which may be transported by ocean vessel, shall be transported on privately owned United States-flag commercial vessels, if available.

(2) Within 20 days following the date of loading for shipments originating within the United States or within 30 working days following the date of loading for shipments originating outside the United States, a legible copy of a rated, 'on-board' commercial ocean bill-of-lading in English for each shipment of cargo described in paragraph (a)(1) of this section shall be furnished to both the Contracting Officer (through the prime contractor in the case of subcontractor bills-of-lading) and to the Division of National Cargo, Office of Market Development, Maritime Administration, Washington, DC 20590."

(b) *Contractor and Subcontractor Clauses*. "Use of United States-flag vessels: The contractor agrees—"

(1) To utilize privately owned United States-flag commercial vessels to ship at least 50 percent of the gross tonnage (computed separately for dry bulk carriers, dry cargo liners, and tankers) involved, whenever shipping any equipment, material, or commodities pursuant to this contract, to the extent such vessels are available at fair and reasonable rates for United States-flag commercial vessels.

(2) To furnish within 20 days following the date of loading for shipments originating within the United States or within 30 working days following the date of loading for shipments originating outside the United States, a legible copy of a rated, 'on-board' commercial ocean bill-of-lading in English for each shipment of cargo described in paragraph (b) (1) of this section to both the Contracting Officer (through the prime contractor in the case of subcontractor bills-of-lading) and to the Division of National Cargo, Office of Market Development, Maritime Administration, Washington, DC 20590.

(3) To insert the substance of the provisions of this clause in all subcontracts issued pursuant to this contract.

**WISCONSIN DEPARTMENT OF TRANSPORTATION  
DIVISION OF TRANSPORTATION AND SYSTEM DEVELOPMENT**

**SUPPLEMENTAL REQUIRED CONTRACT PROVISIONS  
FOR PROJECTS WITH FEDERAL AID**

**I. PREVAILING WAGE RATES**

The attached U.S. Department of Labor (Davis-Bacon Minimum Wage Rates) furnishes the minimum prevailing wage rates pursuant to the Davis-Bacon and Related Acts. The wage rates shown are the minimum rates required by the contract to be paid during its life, however this is not a representation that labor can be obtained at these rates. It is the responsibility of bidders to inform themselves as to the local labor conditions and prospective changes or adjustments of wage rates. No increase in the contract price will be allowed or authorized on account of the payment of wage rates in excess of those listed herein.

**II. COVERAGE OF TRUCK DRIVERS**

Truck drivers are covered by Davis-Bacon Minimum Wage Rates in the following circumstances:

- Drivers of a contractor or subcontractor for time spent working on the site of the work.
- Drivers of a contractor or subcontractor for time spent loading and/or unloading materials and supplies on the site of the work, if such time is not de minimis. [https://www.dol.gov/whd/FOH/FOH\\_Ch15.pdf](https://www.dol.gov/whd/FOH/FOH_Ch15.pdf)
- Truck drivers transporting materials or supplies between a facility that is deemed part of the site of the work and the actual construction site.
- Truck drivers transporting portions of the building or work between a site established specifically for the performance of the contract where a significant portion of such building or work is constructed and the physical place where the building or work called for in the contract will remain.

Truck drivers are not covered by Davis-Bacon Minimum Wage Rates in the following circumstances:

- Material delivery truck drivers while off the site of the work.
- Drivers of a contractor or subcontractor traveling between a Davis-Bacon job and a commercial supply facility while they are off the site of the work.”
- Truck drivers whose time spent on the site of the work is de minimis, such as only a few minutes at a time merely to pick up or drop off materials or supplies.

Details are available online at:

<https://www.dol.gov/whd/recovery/pwrb/Tab9.pdf>

<https://wisconsindot.gov/Pages/doing-bus/civil-rights/labornwage/trckng.aspx>

### **III. POSTINGS AT THE SITE OF THE WORK**

In addition to the required postings furnished by the department, the contractor shall post the following in at least one conspicuous and accessible place at the site of work:

- a. A copy of the contractor's Equal Employment Opportunity Policy.

All required documents shall be posted by the first day of work and be accurate and complete. Postings must be readable, in an area where they will be noticed, and maintained until the last day of work.

### **IV. RESOURCES**

Required information regarding compliance with federal provisions is found in the following resources:

- FHWA-1273 included in this contract
- U.S. Department of Labor Prevailing Wage Resource Book
- U.S. Department of Labor Field Operations Handbook
- U.S. Code of Federal Regulations
- Any applicable law, Act, or Executive Order enacted by the federal government at the time of the letting of this contract

Superseded General Decision Number: WI20210010

State: Wisconsin

Construction Type: Highway

Counties: Wisconsin Statewide.

HIGHWAY, AIRPORT RUNWAY & TAXIWAY CONSTRUCTION PROJECTS (does not include bridges over navigable waters; tunnels; buildings in highway rest areas; and railroad construction)

Note: Contracts subject to the Davis-Bacon Act are generally required to pay at least the applicable minimum wage rate required under Executive Order 14026 or Executive Order 13658. Please note that these Executive Orders apply to covered contracts entered into by the federal government that are subject to the Davis-Bacon Act itself, but do not apply to contracts subject only to the Davis-Bacon Related Acts, including those set forth at 29 CFR 5.1(a)(2)-(60).

If the contract is entered into on or after January 30, 2022, or the contract is renewed or extended (e.g., an option is exercised) on or after January 30, 2022:	. Executive Order 14026 generally applies to the contract. . The contractor must pay all covered workers at least \$15.00 per hour (or the applicable wage rate listed on this wage determination, if it is higher) for all hours spent performing on the contract in 2022.
If the contract was awarded on or between January 1, 2015 and January 29, 2022, and the contract is not renewed or extended on or after January 30, 2022:	. Executive Order 13658 generally applies to the contract. . The contractor must pay all covered workers at least \$11.25 per hour (or the applicable wage rate listed on this wage determination, if it is higher) for all hours spent performing on that contract in 2022.

The applicable Executive Order minimum wage rate will be adjusted annually. If this contract is covered by one of the Executive Orders and a classification considered necessary for performance of work on the contract does not appear on this wage determination, the contractor must still submit a conformance request.

Additional information on contractor requirements and worker protections under the Executive Orders is available at <https://www.dol.gov/agencies/whd/government-contracts>.

1	01/21/2022
2	02/04/2022
3	02/25/2022
4	03/11/2022
5	03/18/2022
6	04/29/2022
7	05/13/2022
8	06/17/2022
9	07/08/2022
10	07/22/2022
11	07/29/2022

BRWI0001-002 06/01/2021

CRAWFORD, JACKSON, JUNEAU, LA CROSSE, MONROE, TREMPLEAU, AND VERNON COUNTIES

	Rates	Fringes
BRICKLAYER.....	\$ 36.81	25.17

-----  
BRWI0002-002 06/01/2021

ASHLAND, BAYFIELD, DOUGLAS, AND IRON COUNTIES

	Rates	Fringes
BRICKLAYER.....	\$ 44.35	23.89

-----  
BRWI0002-005 06/01/2021

ADAMS, ASHLAND, BARRON, BROWN, BURNETT, CALUMET, CHIPPEWA, CLARK, COLUMBIA, DODGE, DOOR, DUNN, FLORENCE, FOND DU LAC, FOREST, GREEN LAKE, IRON, JEFFERSON, KEWAUNEE, LANGLADE, LINCOLN, MANITOWOC, MARATHON, MARINETTE, MARQUETTE, MENOMINEE, OCONTO, ONEIDA, OUTAGAMIE, POLK, PORTAGE, RUSK, ST CROIX, SAUK, SHAWANO, SHEBOYGAN, TAYLOR, VILAS, WALWORTH, WAUPACA, WAUSHARA, WINNEBAGO, AND WOOD COUNTIES

	Rates	Fringes
CEMENT MASON/CONCRETE FINISHER...	\$ 37.73	24.15

-----  
BRWI0003-002 06/01/2021

BROWN, DOOR, FLORENCE, KEWAUNEE, MARINETTE, AND OCONTO COUNTIES

	Rates	Fringes
BRICKLAYER.....	\$ 37.03	24.95

-----  
BRWI0004-002 06/01/2021

KENOSHA, RACINE, AND WALWORTH COUNTIES

	Rates	Fringes
BRICKLAYER.....	\$ 41.30	26.03

-----  
BRWI0006-002 06/01/2021

ADAMS, CLARK, FOREST, LANGLADE, LINCOLN, MARATHON, MENOMINEE, ONEIDA, PORTAGE, PRICE, TAYLOR, VILAS AND WOOD COUNTIES

	Rates	Fringes
BRICKLAYER.....	\$ 37.78	24.20
-----		
BRWI0007-002 06/01/2021		

GREEN, LAFAYETTE, AND ROCK COUNTIES

	Rates	Fringes
BRICKLAYER.....	\$ 38.38	25.31
-----		
BRWI0008-002 06/01/2021		

MILWAUKEE, OZAUKEE, WASHINGTON, AND WAUKESHA COUNTIES

	Rates	Fringes
BRICKLAYER.....	\$ 42.38	24.64
-----		
BRWI0011-002 06/01/2021		

CALUMET, FOND DU LAC, MANITOWOC, AND SHEBOYGAN COUNTIES

	Rates	Fringes
BRICKLAYER.....	\$ 37.03	24.95
-----		
BRWI0019-002 06/01/2021		

BARRON, BUFFALO, BURNETT, CHIPPEWA, DUNN, EAU CLAIRE, PEPIN, PIERCE, POLK, RUSK, ST. CROIX, SAWYER AND WASHBURN COUNTIES

	Rates	Fringes
BRICKLAYER.....	\$ 36.31	25.67
-----		
BRWI0034-002 06/01/2021		

COLUMBIA AND SAUK COUNTIES

	Rates	Fringes
BRICKLAYER.....	\$ 38.53	25.16
-----		
CARP0087-001 05/01/2016		

BURNETT (W. of Hwy 48), PIERCE (W. of Hwy 29), POLK (W. of Hwys 35, 48 & 65), AND ST. CROIX (W. of Hwy 65) COUNTIES

	Rates	Fringes
Carpenter & Piledrivermen.....	\$ 36.85	18.39
-----		
CARP0252-002 06/01/2016		

ADAMS, BARRON, BAYFIELD (Eastern 2/3), BROWN, BUFFALO, BURNETT (E. of Hwy 48), CALUMET, CHIPPEWA, CLARK, COLUMBIA, CRAWFORD, DANE, DODGE, DOOR, DUNN, EAU CLAIRE, FLORENCE (except area bordering Michigan State Line), FOND DU LAC, FOREST, GRANT, GREEN, GREEN LAKE, IOWA, IRON, JACKSON, JEFFERSON,



JUNEAU, KEWAUNEE, LA CROSSE, LAFAYETTE, LANGLADE, LINCOLN, MANITOWOC, MARATHON, MARINETTE (except N.E. corner), MARQUETTE, MENOMINEE, MONROE, OCONTO, ONEIDA, OUTAGAMIE, PEPIN, PIERCE (E. of Hwys 29 & 65), POLK (E. of Hwys 35, 48 & 65), PORTAGE, PRICE, RICHLAND, ROCK, RUSK, SAUK, SAWYER, SHAWANO, SHEBOYGAN, ST CROIX (E. of Hwy 65), TAYLOR, TREMPLEAU, VERNON, VILAS, WALWORTH, WASHBURN, WAUPACA, WAUSHARA, WINNEBAGO, AND WOOD COUNTIES

	Rates	Fringes
CARPENTER		
CARPENTER.....	\$ 33.56	18.00
MILLWRIGHT.....	\$ 35.08	18.35
PILEDRIVER.....	\$ 34.12	18.00
-----		
CARP0252-010	06/01/2016	

ASHLAND COUNTY

	Rates	Fringes
Carpenters		
Carpenter.....	\$ 33.56	18.00
Millwright.....	\$ 35.08	18.35
Pile Driver.....	\$ 34.12	18.00
-----		
CARP0264-003	06/01/2016	

KENOSHA, MILWAUKEE, OZAUKEE, RACINE, WAUKESHA, AND WASHINGTON COUNTIES

	Rates	Fringes
CARPENTER.....	\$ 35.78	22.11
-----		
CARP0361-004	05/01/2018	

BAYFIELD (West of Hwy 63) AND DOUGLAS COUNTIES

	Rates	Fringes
CARPENTER.....	\$ 36.15	20.43
-----		
CARP2337-001	06/01/2016	

ZONE A: MILWAUKEE, OZAUKEE, WAUKESHA AND WASHINGTON

ZONE B: KENOSHA & RACINE

	Rates	Fringes
PILEDRIVERMAN		
Zone A.....	\$ 31.03	22.69
Zone B.....	\$ 31.03	22.69
-----		
ELEC0014-002	12/26/2021	

ASHLAND, BARRON, BAYFIELD, BUFFALO, BURNETT, CHIPPEWA, CLARK (except Maryville, Colby, Unity, Sherman, Fremont, Lynn & Sherwood), CRAWFORD, DUNN, EAU CLAIRE, GRANT, IRON, JACKSON, LA CROSSE, MONROE, PEPIN, PIERCE, POLK, PRICE, RICHLAND, RUSK, ST

CROIX, SAWYER, TAYLOR, TREMPEALEAU, VERNON, AND WASHBURN  
COUNTIES

	Rates	Fringes
Electricians:.....	\$ 37.83	21.89
-----		
ELEC0014-007 05/30/2021		

REMAINING COUNTIES

	Rates	Fringes
Teledata System Installer Installer/Technician.....	\$ 28.50	15.92
<p>Low voltage construction, installation, maintenance and removal of teledata facilities (voice, data, and video) including outside plant, telephone and data inside wire, interconnect, terminal equipment, central offices, PABX, fiber optic cable and equipment, micro waves, V-SAT, bypass, CATV, WAN (wide area networks), LAN (local area networks), and ISDN (integrated systems digital network).</p>		
-----		
ELEC0127-002 06/01/2021		

KENOSHA COUNTY

	Rates	Fringes
Electricians:.....	\$ 43.16	30%+12.70
-----		
ELEC0158-002 05/30/2021		

BROWN, DOOR, KEWAUNEE, MANITOWOC (except Schleswig), MARINETTE (Wausaukee and area South thereof), OCONTO, MENOMINEE (East of a line 6 miles West of the West boundary of Oconto County), SHAWANO (Except Area North of Townships of Aniwa and Hutchins) COUNTIES

	Rates	Fringes
ELECTRICIAN.....	\$ 36.14	29.75%+10.26
-----		
ELEC0159-003 05/30/2021		

COLUMBIA, DANE, DODGE (Area West of Hwy 26, except Chester and Emmet Townships), GREEN, LAKE (except Townships of Berlin, Seneca, and St. Marie), IOWA, MARQUETTE (except Townships of Neshkoka, Crystal Lake, Newton, and Springfield), and SAUK COUNTIES

	Rates	Fringes
ELECTRICIAN.....	\$ 43.38	23.13
-----		
ELEC0219-004 06/01/2019		

FLORENCE COUNTY (Townships of Aurora, Commonwealth, Fern, Florence and Homestead) AND MARINETTE COUNTY (Township of Niagara)

	Rates	Fringes
Electricians:		
Electrical contracts over \$180,000.....	\$ 33.94	21.80
Electrical contracts under \$180,000.....	\$ 31.75	21.73

-----  
ELEC0242-005 05/30/2021

DOUGLAS COUNTY

	Rates	Fringes
Electricians:.....	\$ 41.37	69.25%

-----  
ELEC0388-002 05/30/2021

ADAMS, CLARK (Colby, Freemont, Lynn, Mayville, Sherman, Sherwood, Unity), FOREST, JUNEAU, LANGLADE, LINCOLN, MARATHON, MARINETTE (Beecher, Dunbar, Goodman & Pembine), MENOMINEE (Area West of a line 6 miles West of the West boundary of Oconto County), ONEIDA, PORTAGE, SHAWANO (Aniwa and Hutchins), VILAS AND WOOD COUNTIES

	Rates	Fringes
Electricians:.....	\$ 36.22	26%+11.24

-----  
ELEC0430-002 06/01/2022

RACINE COUNTY (Except Burlington Township)

	Rates	Fringes
Electricians:.....	\$ 45.02	24.35

-----  
ELEC0494-005 06/01/2021

MILWAUKEE, OZAUKEE, WASHINGTON, AND WAUKESHA COUNTIES

	Rates	Fringes
Electricians:.....	\$ 44.39	25.67

-----  
ELEC0494-006 06/01/2021

CALUMET (Township of New Holstein), DODGE (East of Hwy 26 including Chester Township), FOND DU LAC, MANITOWOC (Schleswig), and SHEBOYGAN COUNTIES

	Rates	Fringes
Electricians:.....	\$ 37.91	22.74

-----  
ELEC0494-013 06/01/2021

DODGE (East of Hwy 26 including Chester Twp, excluding Emmet Twp), FOND DU LAC (Except Waupuin), MILWAUKEE, OZAUKEE, MANITOWOC (Schleswig), WASHINGTON, AND WAUKESHA COUNTIES

	Rates	Fringes
Sound & Communications		
Installer.....	\$ 22.39	18.80
Technician.....	\$ 32.49	20.26

Installation, testing, maintenance, operation and servicing of all sound, intercom, telephone interconnect, closed circuit TV systems, radio systems, background music systems, language laboratories, electronic carillon, antenna distribution systems, clock and program systems and low-voltage systems such as visual nurse call, audio/visual nurse call systems, doctors entrance register systems. Includes all wire and cable carrying audio, visual, data, light and radio frequency signals. Includes the installation of conduit, wiremold, or raceways in existing structures that have been occupied for six months or more where required for the protection of the wire or cable, but does not mean a complete conduit or raceway system. work covered does not include the installation of conduit, wiremold or any raceways in any new construction, or the installation of power supply outlets by means of which external electric power is supplied to any of the foregoing equipment or products

-----  
 ELEC0577-003 06/01/2021

CALUMET (except Township of New Holstein), GREEN LAKE (N. part including Townships of Berlin, St Marie, and Seneca), MARQUETTE (N. part including Townships of Crystal Lake, Neshkoro, Newton, and Springfield), OUTAGAMIE, WAUPACA, WAUSHARA, AND WINNEBAGO COUNTIES

	Rates	Fringes
Electricians:.....	\$ 35.66	29.50%+10.00

-----  
 ELEC0890-003 06/01/2021

DODGE (Emmet Township only), GREEN, JEFFERSON, LAFAYETTE, RACINE (Burlington Township), ROCK AND WALWORTH COUNTIES

	Rates	Fringes
Electricians:.....	\$ 39.00	25.95%+11.17

-----  
 ELEC0953-001 06/02/2019

	Rates	Fringes
Line Construction:		
(1) Lineman.....	\$ 47.53	21.43
(2) Heavy Equipment Operator.....	\$ 42.78	19.80
(3) Equipment Operator.....	\$ 38.02	18.40
(4) Heavy Groundman Driver..	\$ 33.27	16.88
(5) Light Groundman Driver..	\$ 30.89	16.11
(6) Groundsman.....	\$ 26.14	14.60

-----  
 ENGI0139-005 06/01/2022

	Rates	Fringes
Power Equipment Operator		
Group 1.....	\$ 43.27	25.95
Group 2.....	\$ 42.77	25.95
Group 3.....	\$ 42.27	25.95
Group 4.....	\$ 42.01	25.95
Group 5.....	\$ 41.72	25.95
Group 6.....	\$ 35.82	25.95

HAZARDOUS WASTE PREMIUMS:

EPA Level "A" protection - \$3.00 per hour  
EPA Level "B" protection - \$2.00 per hour  
EPA Level "C" protection - \$1.00 per hour

POWER EQUIPMENT OPERATORS CLASSIFICATIONS

GROUP 1: Cranes, tower cranes, and derricks with or without attachments with a lifting capacity of over 100 tons; or cranes, tower cranes, and derricks with boom, leads and/or jib lengths measuring 176 feet or longer.

GROUP 2: Cranes, tower cranes and derricks with or without attachments with a lifting capacity of 100 tons or less; or cranes, tower cranes, and derricks with boom, leads, and/or jibs lengths measuring 175 feet or under and Backhoes (excavators) weighing 130,000 lbs and over; caisson rigs; pile driver; dredge operator; dredge engineer; Boat Pilot.

GROUP 3: Mechanic or welder - Heavy duty equipment; cranes with a lifting capacity of 25 tons or under; concrete breaker (manual or remote); vibratory/sonic concrete breaker; concrete laser screed; concrete slipform paver; concrete batch plant operator; concrete pvt. spreader - heavy duty (rubber tired); concrete spreader & distributor; automatic subgrader (concrete); concrete grinder & planing machine; concrete slipform curb & gutter machine; slipform concrete placer; tube finisher; hydro blaster (10,000 psi & over); bridge paver; concrete conveyor system; concrete pump; Rotec type Conveyor; stabilizing mixer (self-propelled); shoulder widener; asphalt plant engineer; bituminous paver; bump cutter & grooving machine; milling machine; screed (bituminous paver); asphalt heater, planer & scarifier; Backhoes (excavators) weighing under 130,000 lbs; grader or motor patrol; tractor (scraper, dozer, pusher, loader); scraper - rubber tired (single or twin engine); endloader; hydraulic backhoe (tractor type); trenching machine; skid rigs; tractor, side boom (heavy); drilling or boring machine (mechanical heavy); roller over 5 tons; percussion or rotary drilling machine; air track; blaster; loading machine (conveyor); tugger; boatmen; winches & A-frames; post driver; material hoist.

GROUP 4: Greaser, roller steel (5 tons or less); roller (pneumatic tired) - self propelled; tractor (mounted or towed compactors & light equipment); shouldering machine; self-propelled chip spreader; concrete spreader; finishing machine; mechanical float; curing machine; power subgrader; joint sawer (multiple blade) belting machine; burlap machine; texturing machine; tractor endloader (rubber tired) - light; jeep digger; forklift; mulcher; launch operator; fireman, environmental burner

GROUP 5: Air compressor; power pack; vibrator hammer and extractor; heavy equipment, leadman; tank car heaters;

stump chipper; curb machine operator; Concrete proportioning plants; generators; mudjack operator; rock breaker; crusher or screening plant; screed (milling machine); automatic belt conveyor and surge bin; pug mill operator; Oiler, pump (over 3 inches); Drilling Machine Tender, day light machine

GROUP 6: Off-road material hauler with or without ejector.

-----  
IRON0008-002 06/01/2021

BROWN, CALUMET, DOOR, FOND DU LAC, KEWAUNEE, MANITOWOC, MARINETTE, OCONTO, OUTAGAMI, SHAWANO, SHEBOYGAN, AND WINNEBAGO COUNTIES:

	Rates	Fringes
IRONWORKER.....	\$ 38.77	28.15

Paid Holidays: New Year's Day, Memorial Day, July 4th, Labor Day, Thanksgiving Day & Christmas Day.

-----  
IRON0008-003 06/01/2021

KENOSHA, MILWAUKEE, OZAUKEE, RACINE, WALWORTH (N.E. 2/3), WASHINGTON, AND WAUKESHA COUNTIES

	Rates	Fringes
IRONWORKER.....	\$ 40.57	28.40

Paid Holidays: New Year's Day, Memorial Day, July 4th, Labor Day, Thanksgiving Day & Christmas Day.

-----  
IRON0383-001 06/05/2022

ADAMS, COLUMBIA, CRAWFORD, DANE, DODGE, FLORENCE, FOREST, GRANT, GREENE, (Excluding S.E. tip), GREEN LAKE, IOWA, JEFFERSON, JUNEAU, LA CROSSE, LAFAYETTE, LANGLADE, MARATHON, MARQUETTE, MENOMINEE, MONROE, PORTAGE, RICHLAND, ROCK (Northern area, vicinity of Edgerton and Milton), SAUK, VERNON, WAUPACA, WAUSHARA, AND WOOD COUNTIES

	Rates	Fringes
IRONWORKER.....	\$ 39.00	28.58

-----  
IRON0498-005 06/01/2021

GREEN (S.E. 1/3), ROCK (South of Edgerton and Milton), and WALWORTH (S.W. 1/3) COUNTIES:

	Rates	Fringes
IRONWORKER.....	\$ 41.37	44.41

-----  
\* IRON0512-008 05/01/2022

BARRON, BUFFALO, CHIPPEWA, CLARK, DUNN, EAU CLAIRE, JACKSON,  
 PEPIN, PIERCE, POLK, RUSK, ST CROIX, TAYLOR, AND TREMPPEALEAU  
 COUNTIES

	Rates	Fringes
IRONWORKER.....	\$ 41.00	33.11

-----  
 \* IRON0512-021 05/01/2022

ASHLAND, BAYFIELD, BURNETT, DOUGLAS, IRON, LINCOLN, ONEIDA,  
 PRICE, SAWYER, VILAS AND WASHBURN COUNTIES

	Rates	Fringes
IRONWORKER.....	\$ 36.94	33.11

-----  
 LABO0113-002 06/01/2022

MILWAUKEE AND WAUKESHA COUNTIES

	Rates	Fringes
LABORER		
Group 1.....	\$ 32.65	23.09
Group 2.....	\$ 32.80	23.09
Group 3.....	\$ 33.00	23.09
Group 4.....	\$ 33.15	23.09
Group 5.....	\$ 33.30	23.09
Group 6.....	\$ 29.14	23.09

LABORERS CLASSIFICATIONS

GROUP 1: General Laborer; Tree Trimmer; Conduit Layer;  
 Demolition and Wrecking Laborer; Guard Rail, Fence, and  
 Bridge Builder; Landscaper; Multiplate Culvert Assembler;  
 Stone Handler; Bituminous Worker (Shoveler, Loader, and  
 Utility Man); Batch Truck Dumper or Cement Handler;  
 Bituminous Worker (Dumper, Ironer, Smoother, and Tamper);  
 Concrete Handler

GROUP 2: Air Tool Operator; Joint Sawyer and Filler  
 (Pavement); Vibrator or Tamper Operator (Mechanical Hand  
 Operated); Chain Saw Operator; Demolition Burning Torch  
 Laborer

GROUP 3: Bituminous Worker (Raker and Luteman); Formsetter  
 (Curb, Sidewalk, and Pavement); Strike Off Man

GROUP 4: Line and Grade Specialist

GROUP 5: Blaster and Powderman

GROUP 6: Flagperson; traffic control person

-----  
 LABO0113-003 06/01/2022

OZAUKEE AND WASHINGTON COUNTIES

	Rates	Fringes
LABORER		

Group 1.....	\$ 31.90	23.09
Group 2.....	\$ 32.00	23.09
Group 3.....	\$ 32.05	23.09
Group 4.....	\$ 32.25	23.09
Group 5.....	\$ 32.10	23.09
Group 6.....	\$ 28.99	23.09

LABORERS CLASSIFICATIONS

GROUP 1: General Laborer; Tree Trimmer; Conduit Layer; Demolition and Wrecking Laborer; Guard Rail, Fence, and Bridge Builder; Landscaper; Multiplate Culvert Assembler; Stone Handler; Bituminous Worker (Shoveler, Loader, and Utility Man); Batch Truck Dumper or Cement Handler; Bituminous Worker (Dumper, Ironer, Smoother, and Tamper); Concrete Handler

GROUP 2: Air Tool Operator; Joint Sawyer and Filler (Pavement); Vibrator or Tamper Operator (Mechanical Hand Operated);

GROUP 3: Bituminous Worker (Raker and Luteman); Formsetter (Curb, Sidewalk, and Pavement); Strike Off Man

GROUP 4: Line and Grade Specialist

GROUP 5: Blaster; powderman

GROUP 6: Flagperson and Traffic Control Person

-----  
LAB00113-011 06/01/2022

KENOSHA AND RACINE COUNTIES

	Rates	Fringes
LABORER		
Group 1.....	\$ 31.71	23.09
Group 2.....	\$ 31.86	23.09
Group 3.....	\$ 32.06	23.09
Group 4.....	\$ 32.03	23.09
Group 5.....	\$ 32.36	23.09
Group 6.....	\$ 28.85	23.09

LABORERS CLASSIFICATIONS:

GROUP 1: General laborer; Tree Trimmer; Conduit Layer; Demolition and Wrecking Laborer; Guard Rail, Fence, and Bridge Builder; Landscaper; Multiplate Culvert Assembler; Stone Handler; Bituminous Worker (Shoveler, Loader, and Utility Man); Batch Truck Dumper or Cement Handler; Bituminous worker (Dumper, Ironer, Smoother, and Tamper); Concrete Handler

GROUP 2: Air Tool Operator; Joint Sawyer and Filler (Pavement); Vibrator or Tamper Operator (Mechanical Hand Operated); Chain Saw Operator; Demolition Burning Torch Laborer

GROUP 3: Bituminous Worker (Raker and Luteman); Formsetter (Curb, Sidewalk, and Pavement); Strike Off Man

GROUP 4: Line and Grade Specialist



GROUP 5: Blaster and Powderman

GROUP 6: Flagman; traffic control person

-----  
LAB00140-002 06/01/2022

ADAMS, ASHLAND, BARRON, BAYFIELD, BROWN, BUFFALO, BURNETT, CALUMET, CHIPPEWA, CLARK, COLUMBIA, CRAWFORD, DODGE, DOOR, DOUGLAS, DUNN, EAU CLAIRE, FLORENCE, FOND DU LAC, FOREST, GRANT, GREEN, GREEN LAKE, IRON, JACKSON, JUNEAU, IOWA, JEFFERSON, KEWAUNEE, LA CROSSE, LAFAYETTE, LANGLADE, LINCOLN, MANITOWOC, MARATHON, MARINETTE, MARQUETTE, MENOMINEE, MONROE, OCONTO, ONEIDA, OUTAGAMIE, PEPIN, PIERCE, POLK, PORTAGE, PRICE, RICHLAND, ROCK, RUSK, SAUK, SAWYER, SHAWANO, SHEBOYGAN, ST. CROIX, TAYLOR, TREMPPEALEAU, VERNON, VILLAS, WALWORTH, WASHBURN, WAUPACA, WAUSHARA, WINNEBAGO, AND WOOD COUNTIES

	Rates	Fringes
LABORER		
Group 1.....	\$ 36.42	18.68
Group 2.....	\$ 36.52	18.68
Group 3.....	\$ 36.57	18.68
Group 4.....	\$ 36.77	18.68
Group 5.....	\$ 36.62	18.68
Group 6.....	\$ 33.05	18.68

LABORER CLASSIFICATIONS

GROUP 1: General Laborer; Tree Trimmer; Conduit Layer; Demolition and Wrecking Laborer; Guard Rail, Fence, and Bridge Builder; Landscaper; Multiplate Culvert Assembler; Stone Handler; Bituminous Worker (Shoveler, Loader, and Utility Man); Batch Truck Dumper or Cement Handler; Bituminous Worker (Dumper, Ironer, Smoother and Tamper); Concrete Handler

GROUP 2: Air Tool Operator; Joint Sawyer and Filler (Pavement); Vibrator or Tamper Operator (Mechanical Hand Operated); Chain Saw Operator, Demolition Burning Torch Laborer

GROUP 3: Bituminous Worker (Raker and Luteman); Formsetter (Curb, Sidewalk and Pavement); Strike Off Man

GROUP 4: Line and Grade Specialist

GROUP 5: Blaster; powderman

GROUP 6: Flagperson; Traffic Control

-----  
LAB00464-003 06/01/2022

DANE COUNTY

	Rates	Fringes
LABORER		
Group 1.....	\$ 36.70	18.68
Group 2.....	\$ 36.80	18.68
Group 3.....	\$ 36.85	18.68
Group 4.....	\$ 37.05	18.68

Group 5.....	\$ 36.90	18.68
Group 6.....	\$ 33.05	18.68

LABORERS CLASSIFICATIONS:

GROUP 1: General Laborer; Tree Trimmer; Conduit Layer; Demolition and Wrecking Laborer; Guard Rail, Fence, and Bridge Builder; Landscaper; Multiplate Culvert Assembler; Stone Handler; Bituminous Worker (Shoveler, Loader, and Utility Man); Batch Truck Dumper or Cement Handler; Bituminous Worker (Dumper, Ironer, Smoother, and Tamper); Concrete Handler

GROUP 2: Air Tool Operator; Joint Sawyer and Filler (Pavement); Vibrator or Tamper Operator (Mechanical Hand Operated); Chain Saw Operator; Demolition Burning Torch Laborer

GROUP 3: Bituminous Worker (Raker and Luteman); Formsetter (Curb, Sidewalk, and Pavement); Strike Off Man

GROUP 4: Line and Grade Specialist

GROUP 5: Blaster; Powderman

GROUP 6: Flagperson and Traffic Control Person

-----  
PAIN0106-008 05/01/2022

ASHLAND, BAYFIELD, BURNETT, AND DOUGLAS COUNTIES

	Rates	Fringes
--	-------	---------

Painters:

New:

Brush, Roller.....	\$ 33.99	22.70
Spray, Sandblast, Steel....	\$ 34.59	22.70

Repaint:

Brush, Roller.....	\$ 33.09	22.70
Spray, Sandblast, Steel....	\$ 32.49	22.70

-----  
PAIN0108-002 06/01/2021

RACINE COUNTY

	Rates	Fringes
--	-------	---------

Painters:

Brush, Roller.....	\$ 36.08	20.36
Spray & Sandblast.....	\$ 37.52	23.27

-----  
PAIN0259-002 05/01/2008

BARRON, CHIPPEWA, DUNN, EAU CLAIRE, PEPIN, PIERCE, POLK, RUSK, SAWYER, ST. CROIX, AND WASHBURN COUNTIES

	Rates	Fringes
--	-------	---------

PAINTER.....	\$ 24.11	12.15
--------------	----------	-------

-----  
PAIN0259-004 05/01/2015

BUFFALO, CRAWFORD, JACKSON, LA CROSSE, MONROE, TREMPLEAU, AND

VERNON COUNTIES

	Rates	Fringes
PAINTER.....	\$ 22.03	12.45
-----		
PAIN0781-002 06/01/2021		

JEFFERSON, MILWAUKEE, OZAUKEE, WASHINGTON, AND WAUKESHA COUNTIES

	Rates	Fringes
Painters:		
Bridge.....	\$ 36.70	24.50
Brush.....	\$ 35.95	24.50
Spray & Sandblast.....	\$ 36.70	24.50
-----		
PAIN0802-002 06/01/2021		

COLUMBIA, DANE, DODGE, GRANT, GREEN, IOWA, LAFAYETTE, RICHLAND, ROCK, AND SAUK COUNTIES

	Rates	Fringes
PAINTER		
Brush.....	\$ 29.98	18.78

PREMIUM PAY:  
Structural Steel, Spray, Bridges = \$1.00 additional per hour.

-----  
PAIN0802-003 06/01/2021

ADAMS, BROWN, CALUMET, CLARK, DOOR, FOND DU LAC, FOREST, GREEN LAKE, IRON, JUNEAU, KEWAUNEE, LANGLADE, LINCOLN, MANITOWOC, MARATHON, MARINETTE, MARQUETTE, MENOMINEE, OCONTO, ONEIDA, OUTAGAMIE, PORTAGE, PRICE, SHAWANO, SHEBOYGAN, TAYLOR, VILAS, WAUSHARA, WAUPACA, WINNEBAGO, AND WOOD COUNTIES

	Rates	Fringes
PAINTER.....	\$ 29.98	18.78
-----		
PAIN0934-001 06/01/2021		

KENOSHA AND WALWORTH COUNTIES

	Rates	Fringes
Painters:		
Brush.....	\$ 36.52	23.27
Spray.....	\$ 37.52	23.27
Structural Steel.....	\$ 36.67	23.27
-----		
PAIN1011-002 06/06/2021		

FLORENCE COUNTY

	Rates	Fringes
Painters:.....	\$ 26.71	14.38

-----  
PLAS0599-010 06/01/2021

	Rates	Fringes
CEMENT MASON/CONCRETE FINISHER		
Area 1.....	\$ 42.06	20.87
Area 2 (BAC).....	\$ 37.73	23.80
Area 3.....	\$ 38.74	22.46
Area 4.....	\$ 38.59	22.66
Area 5.....	\$ 38.16	22.98
Area 6.....	\$ 34.94	26.36

AREA DESCRIPTIONS

AREA 1: BAYFIELD, DOUGLAS, PRICE, SAWYER, AND WASHBURN COUNTIES

AREA 2: ADAMS, ASHLAND, BARRON, BROWN, BURNETT, CALUMET, CHIPPEWA, CLARK, COLUMBIA, DODGE, DOOR, DUNN, FLORENCE, FOND DU LAC, FOREST, GREEN LAKE, IRON, JEFFERSON, KEWAUNEE, LANGLADE, LINCOLN, MANITOWOC, MARATHON, MARINETTE, MARQUETTE, MENOMINEE, OCONTO, ONEIDA, OUTAGAMIE, POLK, PORTAGE, RUSK, ST CROIX, SAUK, SHAWANO, SHEBOYGAN, TAYLOR, VILAS, WALWORTH, WAUPACA, WAUSHARA, WINNEBAGO, AND WOOD COUNTIES

AREA 3: BUFFALO, CRAWFORD, EAU CLAIRE, JACKSON, JUNEAU, LA CROSSE MONROE, PEPIN, PIERCE, RICHLAND, TREMPLEAU, AND VERNON COUNTIES

AREA 4: MILWAUKEE, OZAUKEE, WASHINGTON, AND WAUKESHA COUNTIES

AREA 5: DANE, GRANT, GREEN, IOWA, LAFAYETTE, AND ROCK COUNTIES

AREA 6: KENOSHA AND RACINE COUNTIES

-----  
TEAM0039-001 06/01/2021

	Rates	Fringes
TRUCK DRIVER		
1 & 2 Axles.....	\$ 32.57	23.81
3 or more Axles; Euclids, Dumpton & Articulated, Truck Mechanic.....	\$ 32.72	23.81
-----		
WELL DRILLER.....	\$ 16.52	3.70
-----		

WELDERS - Receive rate prescribed for craft performing operation to which welding is incidental.

=====  
Note: Executive Order (EO) 13706, Establishing Paid Sick Leave for Federal Contractors applies to all contracts subject to the Davis-Bacon Act for which the contract is awarded (and any solicitation was issued) on or after January 1, 2017. If this contract is covered by the EO, the contractor must provide employees with 1 hour of paid sick leave for every 30 hours they work, up to 56 hours of paid sick leave each year.

Employees must be permitted to use paid sick leave for their own illness, injury or other health-related needs, including preventive care; to assist a family member (or person who is like family to the employee) who is ill, injured, or has other health-related needs, including preventive care; or for reasons resulting from, or to assist a family member (or person who is like family to the employee) who is a victim of, domestic violence, sexual assault, or stalking. Additional information on contractor requirements and worker protections under the EO is available at <https://www.dol.gov/agencies/whd/government-contracts>.

Unlisted classifications needed for work not included within the scope of the classifications listed may be added after award only as provided in the labor standards contract clauses (29CFR 5.5 (a) (1) (ii)).

-----

The body of each wage determination lists the classification and wage rates that have been found to be prevailing for the cited type(s) of construction in the area covered by the wage determination. The classifications are listed in alphabetical order of ""identifiers"" that indicate whether the particular rate is a union rate (current union negotiated rate for local), a survey rate (weighted average rate) or a union average rate (weighted union average rate).

#### Union Rate Identifiers

A four letter classification abbreviation identifier enclosed in dotted lines beginning with characters other than ""SU"" or ""UAVG"" denotes that the union classification and rate were prevailing for that classification in the survey. Example: PLUM0198-005 07/01/2014. PLUM is an abbreviation identifier of the union which prevailed in the survey for this classification, which in this example would be Plumbers. 0198 indicates the local union number or district council number where applicable, i.e., Plumbers Local 0198. The next number, 005 in the example, is an internal number used in processing the wage determination. 07/01/2014 is the effective date of the most current negotiated rate, which in this example is July 1, 2014.

Union prevailing wage rates are updated to reflect all rate changes in the collective bargaining agreement (CBA) governing this classification and rate.

#### Survey Rate Identifiers

Classifications listed under the ""SU"" identifier indicate that no one rate prevailed for this classification in the survey and the published rate is derived by computing a weighted average rate based on all the rates reported in the survey for that classification. As this weighted average rate includes all rates reported in the survey, it may include both union and non-union rates. Example: SULA2012-007 5/13/2014. SU indicates the rates are survey rates based on a weighted average calculation of rates and are not majority rates. LA indicates the State of Louisiana. 2012 is the year of survey on which these classifications and rates are based. The next number, 007 in the example, is an internal number used in producing the wage determination. 5/13/2014 indicates the survey completion

date for the classifications and rates under that identifier.

Survey wage rates are not updated and remain in effect until a new survey is conducted.

#### Union Average Rate Identifiers

Classification(s) listed under the UAVG identifier indicate that no single majority rate prevailed for those classifications; however, 100% of the data reported for the classifications was union data. EXAMPLE: UAVG-OH-0010 08/29/2014. UAVG indicates that the rate is a weighted union average rate. OH indicates the state. The next number, 0010 in the example, is an internal number used in producing the wage determination. 08/29/2014 indicates the survey completion date for the classifications and rates under that identifier.

A UAVG rate will be updated once a year, usually in January of each year, to reflect a weighted average of the current negotiated/CBA rate of the union locals from which the rate is based.

---

#### WAGE DETERMINATION APPEALS PROCESS

1.) Has there been an initial decision in the matter? This can be:

- \* an existing published wage determination
- \* a survey underlying a wage determination
- \* a Wage and Hour Division letter setting forth a position on a wage determination matter
- \* a conformance (additional classification and rate) ruling

On survey related matters, initial contact, including requests for summaries of surveys, should be with the Wage and Hour National Office because National Office has responsibility for the Davis-Bacon survey program. If the response from this initial contact is not satisfactory, then the process described in 2.) and 3.) should be followed.

With regard to any other matter not yet ripe for the formal process described here, initial contact should be with the Branch of Construction Wage Determinations. Write to:

Branch of Construction Wage Determinations  
Wage and Hour Division  
U.S. Department of Labor  
200 Constitution Avenue, N.W.  
Washington, DC 20210

2.) If the answer to the question in 1.) is yes, then an interested party (those affected by the action) can request review and reconsideration from the Wage and Hour Administrator (See 29 CFR Part 1.8 and 29 CFR Part 7). Write to:

Wage and Hour Administrator  
U.S. Department of Labor  
200 Constitution Avenue, N.W.  
Washington, DC 20210

The request should be accompanied by a full statement of the

interested party's position and by any information (wage payment data, project description, area practice material, etc.) that the requestor considers relevant to the issue.

3.) If the decision of the Administrator is not favorable, an interested party may appeal directly to the Administrative Review Board (formerly the Wage Appeals Board). Write to:

Administrative Review Board  
U.S. Department of Labor  
200 Constitution Avenue, N.W.  
Washington, DC 20210

4.) All decisions by the Administrative Review Board are final.

=====

END OF GENERAL DECISIO"

**August 2018**

**NOTICE TO BIDDERS  
WAGE RATE DECISION**

The wage rate decision of the Department of Labor which has been incorporated in these advertised specifications is incomplete in that the classifications may be omitted from the Department of Labor's decision.

Since the bidder is responsible, independently, for ascertaining area practice with respect to the necessity, or lack of necessity, for the use of these classifications in the prosecution of the work contemplated by this project, no inference may be drawn from the omission of these classifications concerning prevailing area practices relative to their use. Further, this omission will not, per se, be construed as establishing any governmental liability for increased labor cost if it is subsequently determined that such classifications are required.

There may be omissions and/or errors in the federal wage rates. The bidder is responsible for evaluating and determining the correct applicable rate.

If a project includes multiple types of construction (highway, bridge over navigable water, sanitary sewer and water main, building) and there is not a separate wage determination for this type of work included in the proposal, use the wage determination that is in the proposal.

If a project includes multiple types of construction, different wage rate determinations may be inserted into the contract (WI10/Highway = in all WisDOT highway contracts, WI15/Heavy = bridge over navigable water per USDOL and US Coast Guard designation, WI8/Heavy (Sewer & Water Line & Tunnel) = sanitary sewer and water main if the cost is more than 20% of the contract and/or at least \$1,000,000, and Building). If multiple wage rate determinations are inserted into the contract, use the classification in the wage determination for the work being done. Use WI15 wage rates when working on the bridge and/or structure from bank to bank. Use WI8 wage rates when working on any sanitary sewer or water main work. Use Building wage rates for all work done within the footprint of the building. Use WI10 wage rates for all other highway work in the contract and approaches to structures. For example, if a laborer is working within the footprint of a building, use the Laborer rate in the Building wage determination inserted in the contract. If a laborer is working on a bridge/structure within the banks, use the Laborer rate in the WI15/Heavy wage determination if inserted in the contract. If the laborer is working on the highway, use the Laborer rate in the WI10/Highway wage determination.





## Proposal Schedule of Items

Proposal ID: 20221011004 Project(s): 4085-62-71

Federal ID(s): WISC 2023005

SECTION: 0001

Contract Items

Alt Set ID:

Alt Mbr ID:

Proposal Line Number	Item ID Description	Approximate Quantity and Units	Unit Price	Bid Amount
0002	201.0120 Clearing	5.000 ID	_____.	_____.
0004	201.0220 Grubbing	5.000 ID	_____.	_____.
0006	203.0220 Removing Structure (structure) 01. B-05-052	1.000 EACH	_____.	_____.
0008	204.0100 Removing Concrete Pavement	120.000 SY	_____.	_____.
0010	204.0150 Removing Curb & Gutter	101.000 LF	_____.	_____.
0012	204.0165 Removing Guardrail	1,322.000 LF	_____.	_____.
0014	204.0190 Removing Surface Drains	3.000 EACH	_____.	_____.
0016	205.0100 Excavation Common	59.000 CY	_____.	_____.
0018	206.1000 Excavation for Structures Bridges (structure) 01. B-05-465	LS	LUMP SUM	_____.
0020	208.0100 Borrow	17.000 CY	_____.	_____.
0022	210.1500 Backfill Structure Type A	430.000 TON	_____.	_____.
0024	213.0100 Finishing Roadway (project) 01. 4085-62-71	1.000 EACH	_____.	_____.
0026	305.0110 Base Aggregate Dense 3/4-Inch	70.000 TON	_____.	_____.
0028	305.0120 Base Aggregate Dense 1 1/4-Inch	209.000 TON	_____.	_____.
0030	305.0130 Base Aggregate Dense 3-Inch	404.000 TON	_____.	_____.
0032	415.0410 Concrete Pavement Approach Slab	70.000 SY	_____.	_____.



Proposal Schedule of Items

Proposal ID: 20221011004 Project(s): 4085-62-71

Federal ID(s): WISC 2023005

SECTION: 0001

Contract Items

Alt Set ID:

Alt Mbr ID:

Proposal Line Number	Item ID Description	Approximate Quantity and Units	Unit Price	Bid Amount
0034	416.1010 Concrete Surface Drains	13.000 CY	_____	_____
0036	455.0605 Tack Coat	218.000 GAL	_____	_____
0038	460.2000 Incentive Density HMA Pavement	550.000 DOL	1.00000	550.00
0040	460.6223 HMA Pavement 3 MT 58-28 S	641.000 TON	_____	_____
0042	460.6224 HMA Pavement 4 MT 58-28 S	214.000 TON	_____	_____
0044	502.0100 Concrete Masonry Bridges	568.000 CY	_____	_____
0046	502.3200 Protective Surface Treatment	732.000 SY	_____	_____
0048	502.3210 Pigmented Surface Sealer	269.000 SY	_____	_____
0050	503.0137 Prestressed Girder Type I 36W-Inch	1,180.000 LF	_____	_____
0052	505.0400 Bar Steel Reinforcement HS Structures	12,080.000 LB	_____	_____
0054	505.0600 Bar Steel Reinforcement HS Coated Structures	96,080.000 LB	_____	_____
0056	506.2605 Bearing Pads Elastomeric Non-Laminated	30.000 EACH	_____	_____
0058	506.4000 Steel Diaphragms (structure) 01. B-05-465	16.000 EACH	_____	_____
0060	516.0500 Rubberized Membrane Waterproofing	20.000 SY	_____	_____
0062	550.1100 Piling Steel HP 10-Inch X 42 Lb	1,480.000 LF	_____	_____
0064	550.1120 Piling Steel HP 12-Inch X 53 Lb	2,240.000 LF	_____	_____



## Proposal Schedule of Items

Proposal ID: 20221011004 Project(s): 4085-62-71

Federal ID(s): WISC 2023005

SECTION: 0001

Contract Items

Alt Set ID:

Alt Mbr ID:

Proposal Line Number	Item ID Description	Approximate Quantity and Units	Unit Price	Bid Amount
0066	601.0588 Concrete Curb & Gutter 4-Inch Sloped 36-Inch Type TBT	101.000 LF	_____.	_____.
0068	604.0600 Slope Paving Select Crushed Material	670.000 SY	_____.	_____.
0070	606.0200 Riprap Medium	15.000 CY	_____.	_____.
0072	612.0406 Pipe Underdrain Wrapped 6-Inch	140.000 LF	_____.	_____.
0074	614.0150 Anchor Assemblies for Steel Plate Beam Guard	4.000 EACH	_____.	_____.
0076	614.2300 MGS Guardrail 3	1,251.000 LF	_____.	_____.
0078	614.2500 MGS Thrie Beam Transition	177.000 LF	_____.	_____.
0080	614.2610 MGS Guardrail Terminal EAT	1.000 EACH	_____.	_____.
0082	614.2620 MGS Guardrail Terminal Type 2	2.000 EACH	_____.	_____.
0084	619.1000 Mobilization	1.000 EACH	_____.	_____.
0086	624.0100 Water	11.000 MGAL	_____.	_____.
0088	625.0500 Salvaged Topsoil	2,367.000 SY	_____.	_____.
0090	628.1504 Silt Fence	1,066.000 LF	_____.	_____.
0092	628.1520 Silt Fence Maintenance	1,066.000 LF	_____.	_____.
0094	628.2002 Erosion Mat Class I Type A	510.000 SY	_____.	_____.
0096	628.2004 Erosion Mat Class I Type B	1,838.000 SY	_____.	_____.



Proposal Schedule of Items

Proposal ID: 20221011004 Project(s): 4085-62-71

Federal ID(s): WISC 2023005

SECTION: 0001

Contract Items

Alt Set ID:

Alt Mbr ID:

Proposal Line Number	Item ID Description	Approximate Quantity and Units	Unit Price	Bid Amount
0098	628.7570 Rock Bags	20.000 EACH	_____.	_____.
0100	629.0210 Fertilizer Type B	1.500 CWT	_____.	_____.
0102	630.0170 Seeding Mixture No. 70	11.000 LB	_____.	_____.
0104	630.0200 Seeding Temporary	80.000 LB	_____.	_____.
0106	630.0500 Seed Water	54.000 MGAL	_____.	_____.
0108	642.5001 Field Office Type B	1.000 EACH	_____.	_____.
0110	643.0300 Traffic Control Drums	3,840.000 DAY	_____.	_____.
0112	643.0420 Traffic Control Barricades Type III	2,520.000 DAY	_____.	_____.
0114	643.0705 Traffic Control Warning Lights Type A	3,240.000 DAY	_____.	_____.
0116	643.0715 Traffic Control Warning Lights Type C	3,840.000 DAY	_____.	_____.
0118	643.0900 Traffic Control Signs	8,880.000 DAY	_____.	_____.
0120	643.0910 Traffic Control Covering Signs Type I	1.000 EACH	_____.	_____.
0122	643.0920 Traffic Control Covering Signs Type II	2.000 EACH	_____.	_____.
0124	643.1050 Traffic Control Signs PCMS	14.000 DAY	_____.	_____.
0126	643.5000 Traffic Control	1.000 EACH	_____.	_____.
0128	645.0111 Geotextile Type DF Schedule A	51.000 SY	_____.	_____.
0130	645.0120 Geotextile Type HR	9.000 SY	_____.	_____.



Proposal Schedule of Items

Proposal ID: 20221011004 Project(s): 4085-62-71

Federal ID(s): WISC 2023005

SECTION: 0001

Contract Items

Alt Set ID:

Alt Mbr ID:

Proposal Line Number	Item ID Description	Approximate Quantity and Units	Unit Price	Bid Amount
0132	646.1020 Marking Line Epoxy 4-Inch	559.000 LF	_____.	_____.
0134	650.4500 Construction Staking Subgrade	917.000 LF	_____.	_____.
0136	650.5500 Construction Staking Curb Gutter and Curb & Gutter	101.000 LF	_____.	_____.
0138	650.6500 Construction Staking Structure Layout (structure) 01. B-05-465	LS	LUMP SUM	_____.
0140	650.9910 Construction Staking Supplemental Control (project) 4085-62-71	LS	LUMP SUM	_____.
0142	650.9920 Construction Staking Slope Stakes	917.000 LF	_____.	_____.
0144	690.0150 Sawing Asphalt	28.000 LF	_____.	_____.
0146	690.0250 Sawing Concrete	16.000 LF	_____.	_____.
0148	715.0502 Incentive Strength Concrete Structures	3,000.000 DOL	1.00000	3,000.00
0150	715.0720 Incentive Compressive Strength Concrete Pavement	500.000 DOL	1.00000	500.00
0152	ASP.1T0A On-the-Job Training Apprentice at \$5.00/HR	1,200.000 HRS	5.00000	6,000.00
0154	ASP.1T0G On-the-Job Training Graduate at \$5.00/HR	600.000 HRS	5.00000	3,000.00
0156	SPV.0060 Special 100. Temporary Slope Drain	2.000 EACH	_____.	_____.
0158	SPV.0090 Special 100. Removing Existing Steel Piling	735.000 LF	_____.	_____.
Section: 0001			Total:	_____.

Total Bid: \_\_\_\_\_.

**PLEASE ATTACH ADDENDA HERE**







## Wisconsin Department of Transportation

---

October 4, 2022

**Division of Transportation Systems  
Development**

Bureau of Project Development  
4822 Madison Yards Way, 4<sup>th</sup> Floor South  
Madison, WI 53705

Telephone: (608) 266-1631  
Facsimile (FAX): (608) 266-8459

### **NOTICE TO ALL CONTRACTORS:**

#### **Federal Wage Rate Addendum #01**

#### **Letting of October 11, 2022**

Attached is a copy of the revised WI 10 Highway Davis Bacon Prevailing Wage Rates that are included in proposals 01, 03 – 06, 09, and 13. These wage rates are effective for all proposals they are included in in the October 11, 2022 letting. The updated wage rates are dated September 16, 2022 and are effective on or after September 26, 2022.

The responsibility for notifying potential subcontractors and suppliers of these changes remains with the prime contractors.

Sincerely,

*Mike Coleman*

Proposal Development Specialist  
Proposal Management Section

Superseded General Decision Number: WI20210010

State: Wisconsin

Construction Type: Highway

Counties: Wisconsin Statewide.

HIGHWAY, AIRPORT RUNWAY & TAXIWAY CONSTRUCTION PROJECTS (does not include bridges over navigable waters; tunnels; buildings in highway rest areas; and railroad construction)

Note: Contracts subject to the Davis-Bacon Act are generally required to pay at least the applicable minimum wage rate required under Executive Order 14026 or Executive Order 13658. Please note that these Executive Orders apply to covered contracts entered into by the federal government that are subject to the Davis-Bacon Act itself, but do not apply to contracts subject only to the Davis-Bacon Related Acts, including those set forth at 29 CFR 5.1(a)(2)-(60).

If the contract is entered into on or after January 30, 2022, or the contract is renewed or extended (e.g., an option is exercised) on or after January 30, 2022:	. Executive Order 14026 generally applies to the contract. . The contractor must pay all covered workers at least \$15.00 per hour (or the applicable wage rate listed on this wage determination, if it is higher) for all hours spent performing on the contract in 2022.
If the contract was awarded on or between January 1, 2015 and January 29, 2022, and the contract is not renewed or extended on or after January 30, 2022:	. Executive Order 13658 generally applies to the contract. . The contractor must pay all covered workers at least \$11.25 per hour (or the applicable wage rate listed on this wage determination, if it is higher) for all hours spent performing on that contract in 2022.

The applicable Executive Order minimum wage rate will be adjusted annually. If this contract is covered by one of the Executive Orders and a classification considered necessary for performance of work on the contract does not appear on this wage determination, the contractor must still submit a conformance request.

Additional information on contractor requirements and worker protections under the Executive Orders is available at <https://www.dol.gov/agencies/whd/government-contracts>.

1	01/21/2022
2	02/04/2022
3	02/25/2022
4	03/11/2022
5	03/18/2022
6	04/29/2022
7	05/13/2022
8	06/17/2022
9	07/08/2022
10	07/22/2022
11	07/29/2022
12	08/12/2022
13	09/16/2022

BRWI0001-002 06/01/2021

CRAWFORD, JACKSON, JUNEAU, LA CROSSE, MONROE, TREMPPEALEAU, AND VERNON COUNTIES

	Rates	Fringes
BRICKLAYER.....	\$ 36.81	25.17

-----  
BRWI0002-002 06/01/2021

ASHLAND, BAYFIELD, DOUGLAS, AND IRON COUNTIES

	Rates	Fringes
BRICKLAYER.....	\$ 44.35	23.89

-----  
BRWI0002-005 06/01/2021

ADAMS, ASHLAND, BARRON, BROWN, BURNETT, CALUMET, CHIPPEWA, CLARK, COLUMBIA, DODGE, DOOR, DUNN, FLORENCE, FOND DU LAC, FOREST, GREEN LAKE, IRON, JEFFERSON, KEWAUNEE, LANGLADE, LINCOLN, MANITOWOC, MARATHON, MARINETTE, MARQUETTE, MENOMINEE, OCONTO, ONEIDA, OUTAGAMIE, POLK, PORTAGE, RUSK, ST CROIX, SAUK, SHAWANO, SHEBOYGAN, TAYLOR, VILAS, WALWORTH, WAUPACA, WAUSHARA, WINNEBAGO, AND WOOD COUNTIES

	Rates	Fringes
CEMENT MASON/CONCRETE FINISHER...	\$ 37.73	24.15

-----  
BRWI0003-002 06/01/2021

BROWN, DOOR, FLORENCE, KEWAUNEE, MARINETTE, AND OCONTO COUNTIES

	Rates	Fringes
BRICKLAYER.....	\$ 37.03	24.95

-----  
BRWI0004-002 06/01/2021

KENOSHA, RACINE, AND WALWORTH COUNTIES

	Rates	Fringes
BRICKLAYER.....	\$ 41.30	26.03

-----  
BRWI0006-002 06/01/2021

ADAMS, CLARK, FOREST, LANGLADE, LINCOLN, MARATHON, MENOMINEE,  
ONEIDA, PORTAGE, PRICE, TAYLOR, VILAS AND WOOD COUNTIES

	Rates	Fringes
BRICKLAYER.....	\$ 37.78	24.20
-----		
BRWI0007-002 06/01/2021		

GREEN, LAFAYETTE, AND ROCK COUNTIES

	Rates	Fringes
BRICKLAYER.....	\$ 38.38	25.31
-----		
BRWI0008-002 06/01/2021		

MILWAUKEE, OZAUKEE, WASHINGTON, AND WAUKESHA COUNTIES

	Rates	Fringes
BRICKLAYER.....	\$ 42.38	24.64
-----		
BRWI0011-002 06/01/2021		

CALUMET, FOND DU LAC, MANITOWOC, AND SHEBOYGAN COUNTIES

	Rates	Fringes
BRICKLAYER.....	\$ 37.03	24.95
-----		
BRWI0019-002 06/01/2021		

BARRON, BUFFALO, BURNETT, CHIPPEWA, DUNN, EAU CLAIRE, PEPIN,  
PIERCE, POLK, RUSK, ST. CROIX, SAWYER AND WASHBURN COUNTIES

	Rates	Fringes
BRICKLAYER.....	\$ 36.31	25.67
-----		
BRWI0034-002 06/01/2021		

COLUMBIA AND SAUK COUNTIES

	Rates	Fringes
BRICKLAYER.....	\$ 38.53	25.16
-----		
CARP0087-001 05/01/2016		

BURNETT (W. of Hwy 48), PIERCE (W. of Hwy 29), POLK (W. of Hwys  
35, 48 & 65), AND ST. CROIX (W. of Hwy 65) COUNTIES

	Rates	Fringes
Carpenter & Piledrivermen.....	\$ 36.85	18.39
-----		
CARP0252-002 06/01/2016		

ADAMS, BARRON, BAYFIELD (Eastern 2/3), BROWN, BUFFALO,  
BURNETT (E. of Hwy 48), CALUMET, CHIPPEWA, CLARK, COLUMBIA,  
CRAWFORD, DANE, DODGE, DOOR, DUNN, EAU CLAIRE, FLORENCE (except

area bordering Michigan State Line), FOND DU LAC, FOREST, GRANT, GREEN, GREEN LAKE, IOWA, IRON, JACKSON, JEFFERSON, JUNEAU, KEWAUNEE, LA CROSSE, LAFAYETTE, LANGLADE, LINCOLN, MANITOWOC, MARATHON, MARINETTE (except N.E. corner), MARQUETTE, MENOMINEE, MONROE, OCONTO, ONEIDA, OUTAGAMIE, PEPIN, PIERCE (E. of Hwys 29 & 65), POLK (E. of Hwys 35, 48 & 65), PORTAGE, PRICE, RICHLAND, ROCK, RUSK, SAUK, SAWYER, SHAWANO, SHEBOYGAN, ST CROIX (E. of Hwy 65), TAYLOR, TREMPLEAU, VERNON, VILAS, WALWORTH, WASHBURN, WAUPACA, WAUSHARA, WINNEBAGO, AND WOOD COUNTIES

	Rates	Fringes
CARPENTER		
CARPENTER.....	\$ 33.56	18.00
MILLWRIGHT.....	\$ 35.08	18.35
PILEDRIVER.....	\$ 34.12	18.00
-----		
CARP0252-010 06/01/2016		

ASHLAND COUNTY

	Rates	Fringes
Carpenters		
Carpenter.....	\$ 33.56	18.00
Millwright.....	\$ 35.08	18.35
Pile Driver.....	\$ 34.12	18.00
-----		
CARP0264-003 06/01/2016		

KENOSHA, MILWAUKEE, OZAUKEE, RACINE, WAUKESHA, AND WASHINGTON COUNTIES

	Rates	Fringes
CARPENTER.....	\$ 35.78	22.11
-----		
CARP0361-004 05/01/2018		

BAYFIELD (West of Hwy 63) AND DOUGLAS COUNTIES

	Rates	Fringes
CARPENTER.....	\$ 36.15	20.43
-----		
CARP2337-001 06/01/2016		

ZONE A: MILWAUKEE, OZAUKEE, WAUKESHA AND WASHINGTON

ZONE B: KENOSHA & RACINE

	Rates	Fringes
PILEDRIVERMAN		
Zone A.....	\$ 31.03	22.69
Zone B.....	\$ 31.03	22.69
-----		

\* ELEC0014-002 05/29/2022

ASHLAND, BARRON, BAYFIELD, BUFFALO, BURNETT, CHIPPEWA, CLARK (except Maryville, Colby, Unity, Sherman, Fremont, Lynn &

Sherwood), CRAWFORD, DUNN, EAU CLAIRE, GRANT, IRON, JACKSON, LA CROSSE, MONROE, PEPIN, PIERCE, POLK, PRICE, RICHLAND, RUSK, ST CROIX, SAWYER, TAYLOR, TREMPLEAU, VERNON, AND WASHBURN COUNTIES

	Rates	Fringes
Electricians:.....	\$ 38.49	22.09

-----  
 \* ELEC0014-007 05/29/2022

REMAINING COUNTIES

	Rates	Fringes
Teledata System Installer.....	\$ 29.63	3%+16.18
Installer/Technician.....	\$ 28.50	15.92

Low voltage construction, installation, maintenance and removal of teledata facilities (voice, data, and video) including outside plant, telephone and data inside wire, interconnect, terminal equipment, central offices, PABX, fiber optic cable and equipment, micro waves, V-SAT, bypass, CATV, WAN (wide area networks), LAN (local area networks), and ISDN (integrated systems digital network).

-----  
 ELEC0127-002 06/01/2021

KENOSHA COUNTY

	Rates	Fringes
Electricians:.....	\$ 43.16	30%+12.70

-----  
 ELEC0158-002 05/30/2021

BROWN, DOOR, KEWAUNEE, MANITOWOC (except Schleswig), MARINETTE(Wausaukee and area South thereof), OCONTO, MENOMINEE (East of a line 6 miles West of the West boundary of Oconto County), SHAWANO (Except Area North of Townships of Aniwa and Hutchins) COUNTIES

	Rates	Fringes
ELECTRICIAN.....	\$ 36.14	29.75%+10.26

-----  
 ELEC0159-003 05/30/2021

COLUMBIA, DANE, DODGE (Area West of Hwy 26, except Chester and Emmet Townships), GREEN, LAKE (except Townships of Berlin, Seneca, and St. Marie), IOWA, MARQUETTE (except Townships of Neshkoka, Crystal Lake, Newton, and Springfield), and SAUK COUNTIES

	Rates	Fringes
ELECTRICIAN.....	\$ 43.38	23.13

-----  
 ELEC0219-004 06/01/2019

FLORENCE COUNTY (Townships of Aurora, Commonwealth, Fern,

Florence and Homestead) AND MARINETTE COUNTY (Township of Niagara)

	Rates	Fringes
Electricians:		
Electrical contracts over \$180,000.....	\$ 33.94	21.80
Electrical contracts under \$180,000.....	\$ 31.75	21.73
-----		
ELEC0242-005 05/30/2021		

DOUGLAS COUNTY

	Rates	Fringes
Electricians:.....	\$ 41.37	69.25%
-----		
ELEC0388-002 05/30/2021		

ADAMS, CLARK (Colby, Freemont, Lynn, Mayville, Sherman, Sherwood, Unity), FOREST, JUNEAU, LANGLADE, LINCOLN, MARATHON, MARINETTE (Beecher, Dunbar, Goodman & Pembine), MENOMINEE (Area West of a line 6 miles West of the West boundary of Oconto County), ONEIDA, PORTAGE, SHAWANO (Aniwa and Hutchins), VILAS AND WOOD COUNTIES

	Rates	Fringes
Electricians:.....	\$ 36.22	26%+11.24
-----		
ELEC0430-002 06/01/2022		

RACINE COUNTY (Except Burlington Township)

	Rates	Fringes
Electricians:.....	\$ 45.02	24.35
-----		
ELEC0494-005 06/01/2021		

MILWAUKEE, OZAUKEE, WASHINGTON, AND WAUKESHA COUNTIES

	Rates	Fringes
Electricians:.....	\$ 44.39	25.67
-----		
ELEC0494-006 06/01/2021		

CALUMET (Township of New Holstein), DODGE (East of Hwy 26 including Chester Township), FOND DU LAC, MANITOWOC (Schleswig), and SHEBOYGAN COUNTIES

	Rates	Fringes
Electricians:.....	\$ 37.91	22.74
-----		
ELEC0494-013 06/01/2021		

DODGE (East of Hwy 26 including Chester Twp, excluding Emmet Twp), FOND DU LAC (Except Waupun), MILWAUKEE, OZAUKEE,

MANITOWOC (Schleswig), WASHINGTON, AND WAUKESHA COUNTIES

	Rates	Fringes
Sound & Communications		
Installer.....	\$ 22.39	18.80
Technician.....	\$ 32.49	20.26

Installation, testing, maintenance, operation and servicing of all sound, intercom, telephone interconnect, closed circuit TV systems, radio systems, background music systems, language laboratories, electronic carillon, antenna distribution systems, clock and program systems and low-voltage systems such as visual nurse call, audio/visual nurse call systems, doctors entrance register systems. Includes all wire and cable carrying audio, visual, data, light and radio frequency signals. Includes the installation of conduit, wiremold, or raceways in existing structures that have been occupied for six months or more where required for the protection of the wire or cable, but does not mean a complete conduit or raceway system. work covered does not include the installation of conduit, wiremold or any raceways in any new construction, or the installation of power supply outlets by means of which external electric power is supplied to any of the foregoing equipment or products

-----  
 ELEC0577-003 06/01/2021

CALUMET (except Township of New Holstein), GREEN LAKE (N. part including Townships of Berlin, St Marie, and Seneca), MARQUETTE (N. part including Townships of Crystal Lake, Neshkoro, Newton, and Springfield), OUTAGAMIE, WAUPACA, WAUSHARA, AND WINNEBAGO COUNTIES

	Rates	Fringes
Electricians:.....	\$ 35.66	29.50%+10.00

-----  
 ELEC0890-003 06/01/2021

DODGE (Emmet Township only), GREEN, JEFFERSON, LAFAYETTE, RACINE (Burlington Township), ROCK AND WALWORTH COUNTIES

	Rates	Fringes
Electricians:.....	\$ 39.00	25.95%+11.17

-----  
 ELEC0953-001 06/02/2019

	Rates	Fringes
Line Construction:		
(1) Lineman.....	\$ 47.53	21.43
(2) Heavy Equipment Operator.....	\$ 42.78	19.80
(3) Equipment Operator.....	\$ 38.02	18.40
(4) Heavy Groundman Driver..	\$ 33.27	16.88
(5) Light Groundman Driver..	\$ 30.89	16.11
(6) Groundsman.....	\$ 26.14	14.60

-----



	Rates	Fringes
Power Equipment Operator		
Group 1.....	\$ 43.27	25.95
Group 2.....	\$ 42.77	25.95
Group 3.....	\$ 42.27	25.95
Group 4.....	\$ 42.01	25.95
Group 5.....	\$ 41.72	25.95
Group 6.....	\$ 35.82	25.95

HAZARDOUS WASTE PREMIUMS:

- EPA Level "A" protection - \$3.00 per hour
- EPA Level "B" protection - \$2.00 per hour
- EPA Level "C" protection - \$1.00 per hour

POWER EQUIPMENT OPERATORS CLASSIFICATIONS

GROUP 1: Cranes, tower cranes, and derricks with or without attachments with a lifting capacity of over 100 tons; or cranes, tower cranes, and derricks with boom, leads and/or jib lengths measuring 176 feet or longer.

GROUP 2: Cranes, tower cranes and derricks with or without attachments with a lifting capacity of 100 tons or less; or cranes, tower cranes, and derricks with boom, leads, and/or jibs lengths measuring 175 feet or under and Backhoes (excavators) weighing 130,000 lbs and over; caisson rigs; pile driver; dredge operator; dredge engineer; Boat Pilot.

GROUP 3: Mechanic or welder - Heavy duty equipment; cranes with a lifting capacity of 25 tons or under; concrete breaker (manual or remote); vibratory/sonic concrete breaker; concrete laser screed; concrete slipform paver; concrete batch plant operator; concrete pvt. spreader - heavy duty (rubber tired); concrete spreader & distributor; automatic subgrader (concrete); concrete grinder & planing machine; concrete slipform curb & gutter machine; slipform concrete placer; tube finisher; hydro blaster (10,000 psi & over); bridge paver; concrete conveyor system; concrete pump; Rotec type Conveyor; stabilizing mixer (self-propelled); shoulder widener; asphalt plant engineer; bituminous paver; bump cutter & grooving machine; milling machine; screed (bituminous paver); asphalt heater, planer & scarifier; Backhoes (excavators) weighing under 130,000 lbs; grader or motor patrol; tractor (scraper, dozer, pusher, loader); scraper - rubber tired (single or twin engine); endloader; hydraulic backhoe (tractor type); trenching machine; skid rigs; tractor, side boom (heavy); drilling or boring machine (mechanical heavy); roller over 5 tons; percussion or rotary drilling machine; air track; blaster; loading machine (conveyor); tugger; boatmen; winches & A-frames; post driver; material hoist.

GROUP 4: Greaser, roller steel (5 tons or less); roller (pneumatic tired) - self propelled; tractor (mounted or towed compactors & light equipment); shouldering machine; self-propelled chip spreader; concrete spreader; finishing machine; mechanical float; curing machine; power subgrader; joint sawer (multiple blade) belting machine; burlap machine; texturing machine; tractor endloader (rubber tired) - light; jeep digger; forklift; mulcher; launch operator; fireman, environmental burner

GROUP 5: Air compressor; power pack; vibrator hammer and extractor; heavy equipment, leadman; tank car heaters; stump chipper; curb machine operator; Concrete proportioning plants; generators; mudjack operator; rock breaker; crusher or screening plant; screed (milling machine); automatic belt conveyor and surge bin; pug mill operator; Oiler, pump (over 3 inches); Drilling Machine Tender, day light machine

GROUP 6: Off-road material hauler with or without ejector.

-----  
 IRON0008-002 06/13/2022

BROWN, CALUMET, DOOR, FOND DU LAC, KEWAUNEE, MANITOWOC, MARINETTE, OCONTO, OUTAGAMI, SHAWANO, SHEBOYGAN, AND WINNEBAGO COUNTIES:

	Rates	Fringes
IRONWORKER.....	\$ 41.00	28.95

Paid Holidays: New Year's Day, Memorial Day, July 4th, Labor Day, Thanksgiving Day & Christmas Day.

-----  
 IRON0008-003 06/01/2021

KENOSHA, MILWAUKEE, OZAUKEE, RACINE, WALWORTH (N.E. 2/3), WASHINGTON, AND WAUKESHA COUNTIES

	Rates	Fringes
IRONWORKER.....	\$ 40.57	28.40

Paid Holidays: New Year's Day, Memorial Day, July 4th, Labor Day, Thanksgiving Day & Christmas Day.

-----  
 IRON0383-001 06/05/2022

ADAMS, COLUMBIA, CRAWFORD, DANE, DODGE, FLORENCE, FOREST, GRANT, GREENE, (Excluding S.E. tip), GREEN LAKE, IOWA, JEFFERSON, JUNEAU, LA CROSSE, LAFAYETTE, LANGLADE, MARATHON, MARQUETTE, MENOMINEE, MONROE, PORTAGE, RICHLAND, ROCK (Northern area, vicinity of Edgerton and Milton), SAUK, VERNON, WAUPACA, WAUSHARA, AND WOOD COUNTIES

	Rates	Fringes
IRONWORKER.....	\$ 39.00	28.58

-----  
 IRON0498-005 06/01/2021

GREEN (S.E. 1/3), ROCK (South of Edgerton and Milton), and WALWORTH (S.W. 1/3) COUNTIES:

	Rates	Fringes
IRONWORKER.....	\$ 41.37	44.41

-----

IRON0512-008 05/01/2022

BARRON, BUFFALO, CHIPPEWA, CLARK, DUNN, EAU CLAIRE, JACKSON, PEPIN, PIERCE, POLK, RUSK, ST CROIX, TAYLOR, AND TREMPPEALEAU COUNTIES

	Rates	Fringes
IRONWORKER.....	\$ 41.00	33.11

IRON0512-021 05/01/2022

ASHLAND, BAYFIELD, BURNETT, DOUGLAS, IRON, LINCOLN, ONEIDA, PRICE, SAWYER, VILAS AND WASHBURN COUNTIES

	Rates	Fringes
IRONWORKER.....	\$ 36.94	33.11

LAB00113-002 06/01/2022

MILWAUKEE AND WAUKESHA COUNTIES

	Rates	Fringes
LABORER		
Group 1.....	\$ 32.65	23.09
Group 2.....	\$ 32.80	23.09
Group 3.....	\$ 33.00	23.09
Group 4.....	\$ 33.15	23.09
Group 5.....	\$ 33.30	23.09
Group 6.....	\$ 29.14	23.09

LABORERS CLASSIFICATIONS

GROUP 1: General Laborer; Tree Trimmer; Conduit Layer; Demolition and Wrecking Laborer; Guard Rail, Fence, and Bridge Builder; Landscaper; Multiplate Culvert Assembler; Stone Handler; Bituminous Worker (Shoveler, Loader, and Utility Man); Batch Truck Dumper or Cement Handler; Bituminous Worker (Dumper, Ironer, Smoother, and Tamper); Concrete Handler

GROUP 2: Air Tool Operator; Joint Sawyer and Filler (Pavement); Vibrator or Tamper Operator (Mechanical Hand Operated); Chain Saw Operator; Demolition Burning Torch Laborer

GROUP 3: Bituminous Worker (Raker and Luteman); Formsetter (Curb, Sidewalk, and Pavement); Strike Off Man

GROUP 4: Line and Grade Specialist

GROUP 5: Blaster and Powderman

GROUP 6: Flagperson; traffic control person

LAB00113-003 06/01/2022

OZAUKEE AND WASHINGTON COUNTIES

Rates	Fringes
-------	---------

LABORER

Group 1.....	\$ 31.90	23.09
Group 2.....	\$ 32.00	23.09
Group 3.....	\$ 32.05	23.09
Group 4.....	\$ 32.25	23.09
Group 5.....	\$ 32.10	23.09
Group 6.....	\$ 28.99	23.09

LABORERS CLASSIFICATIONS

GROUP 1: General Laborer; Tree Trimmer; Conduit Layer; Demolition and Wrecking Laborer; Guard Rail, Fence, and Bridge Builder; Landscaper; Multiplate Culvert Assembler; Stone Handler; Bituminous Worker (Shoveler, Loader, and Utility Man); Batch Truck Dumper or Cement Handler; Bituminous Worker (Dumper, Ironer, Smoother, and Tamper); Concrete Handler

GROUP 2: Air Tool Operator; Joint Sawyer and Filler (Pavement); Vibrator or Tamper Operator (Mechanical Hand Operated);

GROUP 3: Bituminous Worker (Raker and Luteman); Formsetter (Curb, Sidewalk, and Pavement); Strike Off Man

GROUP 4: Line and Grade Specialist

GROUP 5: Blaster; powderman

GROUP 6: Flagperson and Traffic Control Person

-----  
LAB00113-011 06/01/2022

KENOSHA AND RACINE COUNTIES

Rates Fringes

LABORER

Group 1.....	\$ 31.71	23.09
Group 2.....	\$ 31.86	23.09
Group 3.....	\$ 32.06	23.09
Group 4.....	\$ 32.03	23.09
Group 5.....	\$ 32.36	23.09
Group 6.....	\$ 28.85	23.09

LABORERS CLASSIFICATIONS:

GROUP 1: General laborer; Tree Trimmer; Conduit Layer; Demolition and Wrecking Laborer; Guard Rail, Fence, and Bridge Builder; Landscaper; Multiplate Culvert Assembler; Stone Handler; Bituminous Worker (Shoveler, Loader, and Utility Man); Batch Truck Dumper or Cement Handler; Bituminous worker (Dumper, Ironer, Smoother, and Tamper); Concrete Handler

GROUP 2: Air Tool Operator; Joint Sawyer and Filler (Pavement); Vibrator or Tamper Operator (Mechanical Hand Operated); Chain Saw Operator; Demolition Burning Torch Laborer

GROUP 3: Bituminous Worker (Raker and Luteman); Formsetter (Curb, Sidewalk, and Pavement); Strike Off Man

GROUP 4: Line and Grade Specialist

GROUP 5: Blaster and Powderman

GROUP 6: Flagman; traffic control person

-----  
LAB00140-002 06/01/2022

ADAMS, ASHLAND, BARRON, BAYFIELD, BROWN, BUFFALO, BURNETT,  
CALUMET, CHIPPEWA, CLARK, COLUMBIA, CRAWFORD, DODGE, DOOR,  
DOUGLAS, DUNN, EAU CLAIRE, FLORENCE, FOND DU LAC, FOREST,  
GRANT, GREEN, GREEN LAKE, IRON, JACKSON, JUNEAU, IOWA,  
JEFFERSON, KEWAUNEE, LA CROSSE, LAFAYETTE, LANGLADE, LINCOLN,  
MANITOWOC, MARATHON, MARINETTE, MARQUETTE, MENOMINEE, MONROE,  
OCONTO, ONEIDA, OUTAGAMIE, PEPIN, PIERCE, POLK, PORTAGE, PRICE,  
RICHLAND, ROCK, RUSK, SAUK, SAWYER, SHAWANO, SHEBOYGAN, ST.  
CROIX, TAYLOR, TREMPLEAU, VERNON, VILLAS, WALWORTH, WASHBURN,  
WAUPACA, WAUSHARA, WINNEBAGO, AND WOOD COUNTIES

	Rates	Fringes
LABORER		
Group 1.....	\$ 36.42	18.68
Group 2.....	\$ 36.52	18.68
Group 3.....	\$ 36.57	18.68
Group 4.....	\$ 36.77	18.68
Group 5.....	\$ 36.62	18.68
Group 6.....	\$ 33.05	18.68

LABORER CLASSIFICATIONS

GROUP 1: General Laborer; Tree Trimmer; Conduit Layer;  
Demolition and Wrecking Laborer; Guard Rail, Fence, and  
Bridge Builder; Landscaper; Multiplate Culvert Assembler;  
Stone Handler; Bituminous Worker (Shoveler, Loader, and  
Utility Man); Batch Truck Dumper or Cement Handler;  
Bituminous Worker (Dumper, Ironer, Smoother and Tamper);  
Concrete Handler

GROUP 2: Air Tool Operator; Joint Sawyer and Filler  
(Pavement); Vibrator or Tamper Operator (Mechanical Hand  
Operated); Chain Saw Operator, Demolition Burning Torch  
Laborer

GROUP 3: Bituminous Worker (Raker and Luteman); Formsetter  
(Curb, Sidewalk and Pavement); Strike Off Man

GROUP 4: Line and Grade Specialist

GROUP 5: Blaster; powderman

GROUP 6: Flagperson; Traffic Control

-----  
LAB00464-003 06/01/2022

DANE COUNTY

	Rates	Fringes
LABORER		
Group 1.....	\$ 36.70	18.68
Group 2.....	\$ 36.80	18.68

Group 3.....	\$ 36.85	18.68
Group 4.....	\$ 37.05	18.68
Group 5.....	\$ 36.90	18.68
Group 6.....	\$ 33.05	18.68

LABORERS CLASSIFICATIONS:

GROUP 1: General Laborer; Tree Trimmer; Conduit Layer; Demolition and Wrecking Laborer; Guard Rail, Fence, and Bridge Builder; Landscaper; Multiplate Culvert Assembler; Stone Handler; Bituminous Worker (Shoveler, Loader, and Utility Man); Batch Truck Dumper or Cement Handler; Bituminous Worker (Dumper, Ironer, Smoother, and Tamper); Concrete Handler

GROUP 2: Air Tool Operator; Joint Sawyer and Filler (Pavement); Vibrator or Tamper Operator (Mechanical Hand Operated); Chain Saw Operator; Demolition Burning Torch Laborer

GROUP 3: Bituminous Worker (Raker and Luteman); Formsetter (Curb, Sidewalk, and Pavement); Strike Off Man

GROUP 4: Line and Grade Specialist

GROUP 5: Blaster; Powderman

GROUP 6: Flagperson and Traffic Control Person

-----  
PAIN0106-008 05/01/2022

ASHLAND, BAYFIELD, BURNETT, AND DOUGLAS COUNTIES

	Rates	Fringes
Painters:		
New:		
Brush, Roller.....	\$ 33.99	22.70
Spray, Sandblast, Steel....	\$ 34.59	22.70
Repaint:		
Brush, Roller.....	\$ 33.09	22.70
Spray, Sandblast, Steel....	\$ 32.49	22.70

-----  
PAIN0108-002 06/01/2021

RACINE COUNTY

	Rates	Fringes
Painters:		
Brush, Roller.....	\$ 36.08	20.36
Spray & Sandblast.....	\$ 37.52	23.27

-----  
PAIN0259-002 05/01/2008

BARRON, CHIPPEWA, DUNN, EAU CLAIRE, PEPIN, PIERCE, POLK, RUSK, SAWYER, ST. CROIX, AND WASHBURN COUNTIES

	Rates	Fringes
PAINTER.....	\$ 24.11	12.15

-----  
PAIN0259-004 05/01/2015

BUFFALO, CRAWFORD, JACKSON, LA CROSSE, MONROE, TREMPLEAU, AND  
VERNON COUNTIES

	Rates	Fringes
PAINTER.....	\$ 22.03	12.45

---

PAIN0781-002 06/01/2021

JEFFERSON, MILWAUKEE, OZAUKEE, WASHINGTON, AND WAUKESHA COUNTIES

	Rates	Fringes
Painters:		
Bridge.....	\$ 36.70	24.50
Brush.....	\$ 35.95	24.50
Spray & Sandblast.....	\$ 36.70	24.50

---

PAIN0802-002 06/01/2021

COLUMBIA, DANE, DODGE, GRANT, GREEN, IOWA, LAFAYETTE, RICHLAND,  
ROCK, AND SAUK COUNTIES

	Rates	Fringes
PAINTER		
Brush.....	\$ 29.98	18.78

PREMIUM PAY:

Structural Steel, Spray, Bridges = \$1.00 additional per  
hour.

---

PAIN0802-003 06/01/2021

ADAMS, BROWN, CALUMET, CLARK, DOOR, FOND DU LAC, FOREST, GREEN  
LAKE, IRON, JUNEAU, KEWAUNEE, LANGLADE, LINCOLN, MANITOWOC,  
MARATHON, MARINETTE, MARQUETTE, MENOMINEE, OCONTO, ONEIDA,  
OUTAGAMIE, PORTAGE, PRICE, SHAWANO, SHEBOYGAN, TAYLOR, VILAS,  
WAUSHARA, WAUPACA, WINNEBAGO, AND WOOD COUNTIES

	Rates	Fringes
PAINTER.....	\$ 29.98	18.78

---

PAIN0934-001 06/01/2021

KENOSHA AND WALWORTH COUNTIES

	Rates	Fringes
Painters:		
Brush.....	\$ 36.52	23.27
Spray.....	\$ 37.52	23.27
Structural Steel.....	\$ 36.67	23.27

---

PAIN1011-002 06/06/2021

FLORENCE COUNTY

Rates	Fringes
-------	---------

Painters:.....\$ 26.71 14.38

-----  
PLAS0599-010 06/01/2021

	Rates	Fringes
CEMENT MASON/CONCRETE FINISHER		
Area 1.....	\$ 42.06	20.87
Area 2 (BAC).....	\$ 37.73	23.80
Area 3.....	\$ 38.74	22.46
Area 4.....	\$ 38.59	22.66
Area 5.....	\$ 38.16	22.98
Area 6.....	\$ 34.94	26.36

AREA DESCRIPTIONS

AREA 1: BAYFIELD, DOUGLAS, PRICE, SAWYER, AND WASHBURN COUNTIES

AREA 2: ADAMS, ASHLAND, BARRON, BROWN, BURNETT, CALUMET, CHIPPEWA, CLARK, COLUMBIA, DODGE, DOOR, DUNN, FLORENCE, FOND DU LAC, FOREST, GREEN LAKE, IRON, JEFFERSON, KEWAUNEE, LANGLADE, LINCOLN, MANITOWOC, MARATHON, MARINETTE, MARQUETTE, MENOMINEE, OCONTO, ONEIDA, OUTAGAMIE, POLK, PORTAGE, RUSK, ST CROIX, SAUK, SHAWANO, SHEBOYGAN, TAYLOR, VILAS, WALWORTH, WAUPACA, WAUSHARA, WINNEBAGO, AND WOOD COUNTIES

AREA 3: BUFFALO, CRAWFORD, EAU CLAIRE, JACKSON, JUNEAU, LA CROSSE MONROE, PEPIN, PIERCE, RICHLAND, TREMPLEAU, AND VERNON COUNTIES

AREA 4: MILWAUKEE, OZAUKEE, WASHINGTON, AND WAUKESHA COUNTIES

AREA 5: DANE, GRANT, GREEN, IOWA, LAFAYETTE, AND ROCK COUNTIES

AREA 6: KENOSHA AND RACINE COUNTIES

-----  
TEAM0039-001 06/01/2021

	Rates	Fringes
TRUCK DRIVER		
1 & 2 Axles.....	\$ 32.57	23.81
3 or more Axles; Euclids, Dumpton & Articulated, Truck Mechanic.....	\$ 32.72	23.81
-----		
WELL DRILLER.....	\$ 16.52	3.70
-----		

WELDERS - Receive rate prescribed for craft performing operation to which welding is incidental.

=====

Note: Executive Order (EO) 13706, Establishing Paid Sick Leave for Federal Contractors applies to all contracts subject to the Davis-Bacon Act for which the contract is awarded (and any solicitation was issued) on or after January 1, 2017. If this contract is covered by the EO, the contractor must provide



employees with 1 hour of paid sick leave for every 30 hours they work, up to 56 hours of paid sick leave each year. Employees must be permitted to use paid sick leave for their own illness, injury or other health-related needs, including preventive care; to assist a family member (or person who is like family to the employee) who is ill, injured, or has other health-related needs, including preventive care; or for reasons resulting from, or to assist a family member (or person who is like family to the employee) who is a victim of, domestic violence, sexual assault, or stalking. Additional information on contractor requirements and worker protections under the EO is available at <https://www.dol.gov/agencies/whd/government-contracts>.

Unlisted classifications needed for work not included within the scope of the classifications listed may be added after award only as provided in the labor standards contract clauses (29CFR 5.5 (a) (1) (ii)).

-----

The body of each wage determination lists the classification and wage rates that have been found to be prevailing for the cited type(s) of construction in the area covered by the wage determination. The classifications are listed in alphabetical order of ""identifiers"" that indicate whether the particular rate is a union rate (current union negotiated rate for local), a survey rate (weighted average rate) or a union average rate (weighted union average rate).

#### Union Rate Identifiers

A four letter classification abbreviation identifier enclosed in dotted lines beginning with characters other than ""SU"" or ""UAVG"" denotes that the union classification and rate were prevailing for that classification in the survey. Example: PLUM0198-005 07/01/2014. PLUM is an abbreviation identifier of the union which prevailed in the survey for this classification, which in this example would be Plumbers. 0198 indicates the local union number or district council number where applicable, i.e., Plumbers Local 0198. The next number, 005 in the example, is an internal number used in processing the wage determination. 07/01/2014 is the effective date of the most current negotiated rate, which in this example is July 1, 2014.

Union prevailing wage rates are updated to reflect all rate changes in the collective bargaining agreement (CBA) governing this classification and rate.

#### Survey Rate Identifiers

Classifications listed under the ""SU"" identifier indicate that no one rate prevailed for this classification in the survey and the published rate is derived by computing a weighted average rate based on all the rates reported in the survey for that classification. As this weighted average rate includes all rates reported in the survey, it may include both union and non-union rates. Example: SULA2012-007 5/13/2014. SU indicates the rates are survey rates based on a weighted average calculation of rates and are not majority rates. LA indicates the State of Louisiana. 2012 is the year of survey on which these classifications and rates are based. The next number, 007

in the example, is an internal number used in producing the wage determination. 5/13/2014 indicates the survey completion date for the classifications and rates under that identifier.

Survey wage rates are not updated and remain in effect until a new survey is conducted.

#### Union Average Rate Identifiers

Classification(s) listed under the UAVG identifier indicate that no single majority rate prevailed for those classifications; however, 100% of the data reported for the classifications was union data. EXAMPLE: UAVG-OH-0010 08/29/2014. UAVG indicates that the rate is a weighted union average rate. OH indicates the state. The next number, 0010 in the example, is an internal number used in producing the wage determination. 08/29/2014 indicates the survey completion date for the classifications and rates under that identifier.

A UAVG rate will be updated once a year, usually in January of each year, to reflect a weighted average of the current negotiated/CBA rate of the union locals from which the rate is based.

---

#### WAGE DETERMINATION APPEALS PROCESS

1.) Has there been an initial decision in the matter? This can be:

- \* an existing published wage determination
- \* a survey underlying a wage determination
- \* a Wage and Hour Division letter setting forth a position on a wage determination matter
- \* a conformance (additional classification and rate) ruling

On survey related matters, initial contact, including requests for summaries of surveys, should be with the Wage and Hour National Office because National Office has responsibility for the Davis-Bacon survey program. If the response from this initial contact is not satisfactory, then the process described in 2.) and 3.) should be followed.

With regard to any other matter not yet ripe for the formal process described here, initial contact should be with the Branch of Construction Wage Determinations. Write to:

Branch of Construction Wage Determinations  
Wage and Hour Division  
U.S. Department of Labor  
200 Constitution Avenue, N.W.  
Washington, DC 20210

2.) If the answer to the question in 1.) is yes, then an interested party (those affected by the action) can request review and reconsideration from the Wage and Hour Administrator (See 29 CFR Part 1.8 and 29 CFR Part 7). Write to:

Wage and Hour Administrator  
U.S. Department of Labor  
200 Constitution Avenue, N.W.  
Washington, DC 20210

The request should be accompanied by a full statement of the interested party's position and by any information (wage payment data, project description, area practice material, etc.) that the requestor considers relevant to the issue.

3.) If the decision of the Administrator is not favorable, an interested party may appeal directly to the Administrative Review Board (formerly the Wage Appeals Board). Write to:

Administrative Review Board  
U.S. Department of Labor  
200 Constitution Avenue, N.W.  
Washington, DC 20210

4.) All decisions by the Administrative Review Board are final.

=====

END OF GENERAL DECISIO"





# Wisconsin Department of Transportation

## Division of Transportation Systems Development

Bureau of Project Development  
4822 Madison Yards Way, 4<sup>th</sup> Floor South  
Madison, WI 53705

October 4, 2022

Telephone: (608) 266-1631  
Facsimile (FAX): (608) 266-8459

### NOTICE TO ALL CONTRACTORS:

**Proposal #04: 4085-62-71, WISC 2023005**  
**City of De Pere, Greenleaf Road**  
**STH 32 Northbound over CTH PP**  
**STH 32**  
**Brown County**

### Letting of October 11, 2022

This is Addendum No. 01, which provides for the following:

#### Schedule of Items:

Revised Bid Item Quantities					
Bid Item	Item Description	Unit	Old Quantity	Revised Quantity	Proposal Total
455.0605	Tack Coat	GAL	218	-193	25
460.6223	HMA Pavement 3 MT 58-28 S	TON	641	-569	72
460.6224	HMA Pavement 4 MT 58-28 S	TON	214	-190	24
502.0100	Concrete Masonry Bridges	CY	568	6	574
505.0600	Bar Steel Reinforcement HS Coated Structures	LB	96,080	120	96,200

#### Plan Sheets:

Revised Plan Sheets	
Plan Sheet	Plan Sheet Title (brief description of changes to sheet)
16	Miscellaneous Quantities – Updated quantities in Pavement Items table
55	General Plan – Pier elevations revised
56	Cross Section and Quantities – Updated Total Estimated Quantities table
57	Subsurface Exploration – Pier footing elevations revised
64	Pier 1 – Pier footing elevations and dimensions revised
65	Pier 1 Details – Bar bend and bar lengths updated
66	Pier 2 – Pier footing elevations and dimensions revised
67	Pier 2 Details – Bar bend and bar lengths updated

**Schedule of Items**

Attached, dated October 4, 2022, are the revised Schedule of Items Page 2.

**Plan Sheets**

The following 8½ x 11-inch sheets are attached and made part of the plans for this proposal:

Revised: 16, 55, 56, 57, 64, 65, 66, and 67.

The responsibility for notifying potential subcontractors and suppliers of these changes remains with the prime contractor.

Sincerely,

*Mike Coleman*

Proposal Development Specialist  
Proposal Management Section

END OF ADDENDUM

Addendum No. 01  
ID 4085-62-71  
Revised Sheet 16  
October 4, 2022

BASE AGGREGATE

STATION	TO	STATION	LOCATION	STATION	TO	STATION	LOCATION	STATION	TO	STATION	LOCATION	REMARKS
648+77	-	648+99	STH 32	305.0110	-	305.0120	624.0100	305.0130	-	305.0140	624.0100	CONCRETE APPROACH SLAB
651+29	-	651+56	STH 32	BASE AGGREGATE DENSE 1 1/4-INCH	13	BASE AGGREGATE DENSE 3-INCH	-	CONCRETE APPROACH SLAB	-	CONCRETE APPROACH SLAB	-	CONCRETE APPROACH SLAB
648+27	-	648+77	STH 32	AGGREGATE DENSE 3/4-INCH	16	WATER	0.2	CONCRETE APPROACH SLAB	-	CONCRETE APPROACH SLAB	-	CONCRETE APPROACH SLAB
651+56	-	652+05	STH 32	TON	98	MGAL	5.4	CONCRETE APPROACH SLAB	-	CONCRETE APPROACH SLAB	-	CONCRETE APPROACH SLAB
				PROJECT TOTAL	82	186	4.4		404		11	

PAVEMENT ITEMS

STATION	TO	STATION	LOCATION	STATION	TO	STATION	LOCATION	STATION	TO	STATION	LOCATION	REMARKS
648+77	-	648+99	STH 32	213.0100.01	-	213.0110.01	460.6223	415.0410	-	415.0420	460.6224	HMA PAVEMENT
651+29	-	651+56	STH 32	FINISHING ROADWAY (PROJECT) 001	33	CONCRETE PAVEMENT	-	CONCRETE PAVEMENT	-	CONCRETE PAVEMENT	-	HMA PAVEMENT
648+27	-	648+77	STH 32	4085-62-71	37	APPROACH SLAB	-	CONCRETE PAVEMENT	-	CONCRETE PAVEMENT	-	HMA PAVEMENT
651+56	-	652+05	STH 32	EACH	1	SY	-	CONCRETE PAVEMENT	-	CONCRETE PAVEMENT	-	HMA PAVEMENT
				PROJECT TOTAL	1	70	25	72	24			

CURB & GUTTER

STATION	TO	STATION	LOCATION	STATION	TO	STATION	LOCATION	STATION	TO	STATION	LOCATION	REMARKS
639+07	-	639+21	STH 32 RT	601.0588	-	601.0588	CONCRETE CURB & GUTTER 4-INCH SLOPED 36-INCH TYPE 1BT	648+77	-	648+99	STH 32	CONCRETE APPROACH SLAB
648+72	-	648+86	STH 32 LT	CONCRETE CURB & GUTTER 4-INCH SLOPED 36-INCH TYPE 1BT	38	CONCRETE CURB & GUTTER 4-INCH SLOPED 36-INCH TYPE 1BT	-	648+99	-	651+29	STH 32	BRIDGE
651+62	-	651+76	STH 32 LT	PROJECT TOTAL	35	PROJECT TOTAL	101	651+29	-	651+56	STH 32	CONCRETE APPROACH SLAB
					28							

PAVEMENT MARKINGS

MARKING LINE	LE	LOCATION	LOCATION	LE	REMARKS
646.1020	37	STH 32	STH 32	37	CONCRETE APPROACH SLAB
EPOXY 4-INCH	480	STH 32	STH 32	480	BRIDGE
	42	STH 32	STH 32	42	CONCRETE APPROACH SLAB
	559	PROJECT TOTAL	PROJECT TOTAL	559	

PROJECT NO: 4085-62-71

HWY: STH 32

COUNTY: BROWN

MISCELLANEOUS QUANTITIES

SHEET: 16

E

FILE NAME : N:\PDS\...030200\_mq.ppk

PLOT DATE : September 29, 2022

PLOT BY : MM.J.

PLOT SCALE : 1:1

Addendum No. 01  
 ID 4085-62-71  
 Revised Sheet 55  
 October 4, 2022

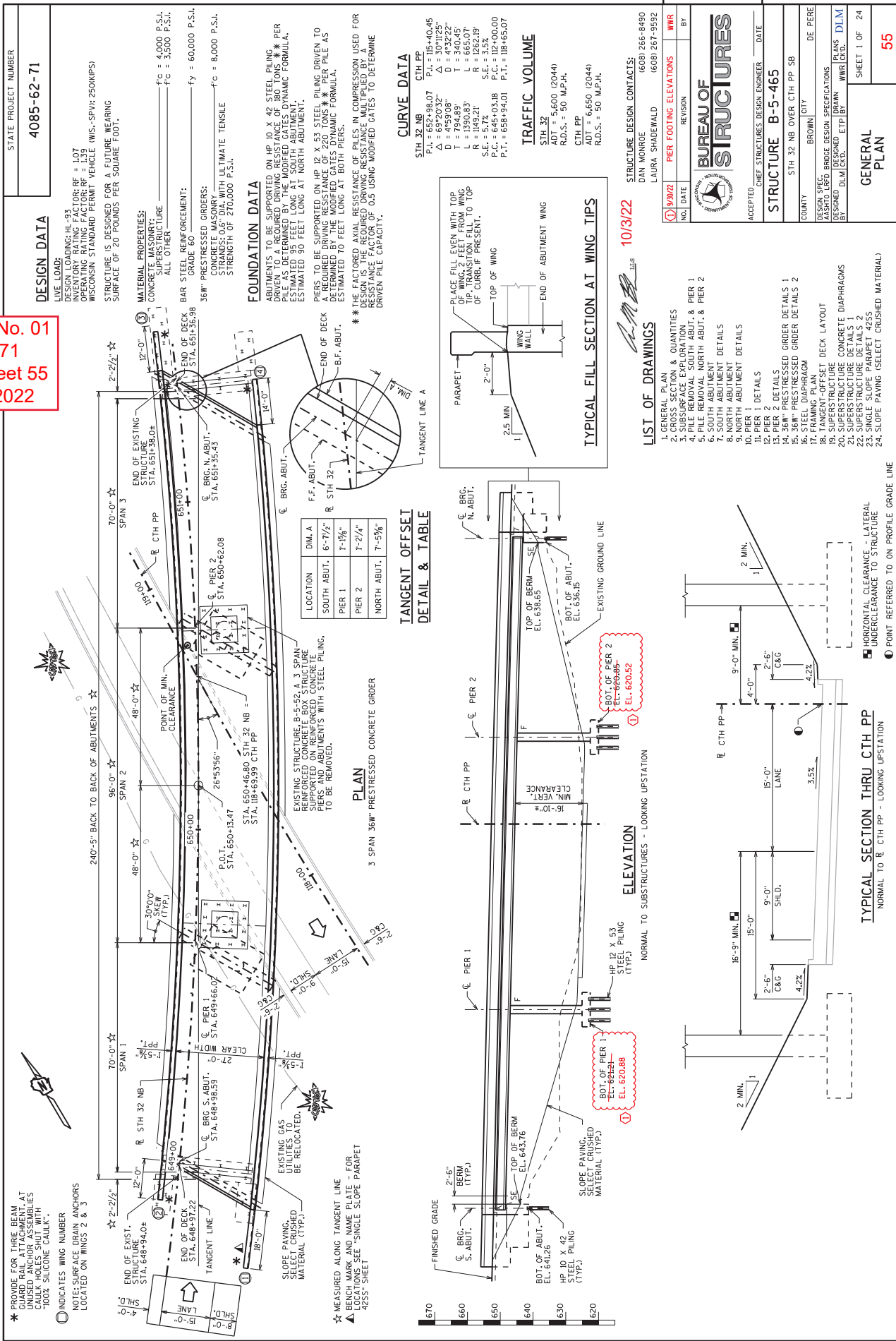



STATE PROJECT NUMBER  
**4085-62-71**

**GENERAL NOTES**

- DRAWINGS SHALL NOT BE SCALED.
- BAR STEEL REINFORCEMENT SHALL BE EMBEDDED 2" CLEAR UNLESS OTHERWISE SHOWN OR NOTED.
- THE FIRST OR FIRST TWO DIGITS OF THE BAR MARK SIGNIFIES THE BAR SIZE.
- BEVEL EXPOSED EDGES OF CONCRETE 3/4" UNLESS OTHERWISE NOTED.
- THE UPPER LIMITS OF "EXCAVATION FOR STRUCTURES BRIDGES B-5-465" SHALL BE "THE EXISTING GROUNDLINE."
- AT THE BACK FACE OF ABUTMENT ALL VOLUME WHICH CANNOT BE PLACED BEFORE ABUTMENT CONSTRUCTION AND IS NOT OCCUPIED BY THE NEW STRUCTURE SHALL BE BACKFILLED WITH STRUCTURE BACKFILL TYPE A.
- EXCAVATION BELOW THE ABUTMENT AND ABUTMENT BEDDING SHALL BE EXTENDED TO THE BOTTOM OF EXCAVATION AND EXTEND 2'-0" ABOVE BOTTOM OF ABUTMENT.
- THE QUANTITY FOR BACKFILL STRUCTURE IS CALCULATED BASED ON THE DETAIL SHOWN IN THE PLANS.
- ELASTOMERIC BEARING PADS NEED NOT BE INDIVIDUALLY MOLDED PROVIDED THE CUT EDGES ARE SMOOTH AND TRUE.
- PROTECTIVE SURFACE TREATMENT TO BE APPLIED TO THE ENTIRE HORIZONTAL SURFACES OF THE PAVING NOTCHES AT ABUTMENT DIAPHRAGMS.
- PIGMENTED SURFACE SEALER TO BE APPLIED TO THE FRONT FACE AND THE TOP OF THE PARAPETS, INCLUDING PARAPETS ON WINGS.
- THE SLOPE OF THE FILL IN FRONT OF THE ABUTMENTS SHALL BE COVERED WITH SLOPE PAVING MATERIAL TO THE EXTENT SHOWN ON SHEET 1 AND THE ABUTMENT DETAILS.
- THE HAUNCH CONCRETE QUANTITY IS BASED ON THE AVERAGE HAUNCH SHOWN ON THE "36" PRESTRESSED GIRDER DETAILS 2" AT ABUTMENTS; HP 12X53 STEEL PILING MAY BE USED IN LIEU OF HP 10X42 STEEL PILING. PAYMENT SHALL BE BASED ON BID PRICE FOR HP 10X42 STEEL PILING.

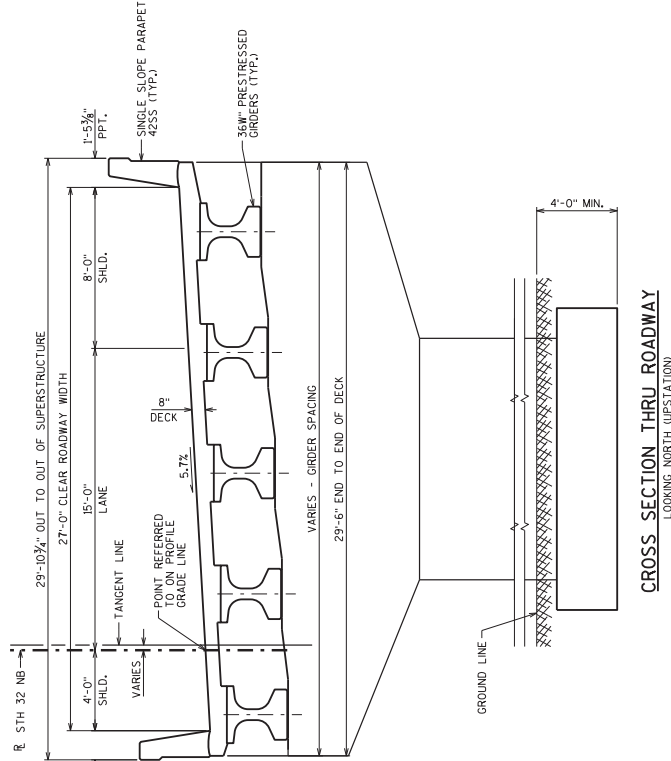
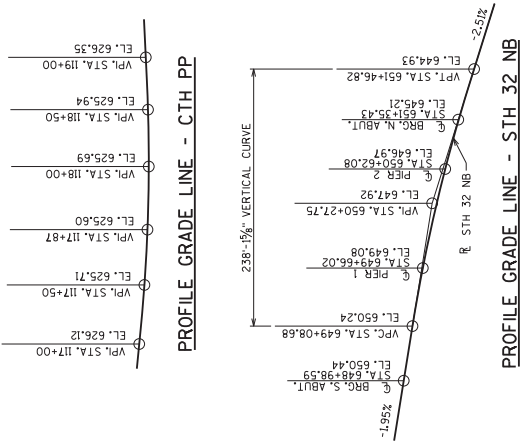

**CROSS SECTION THRU ROADWAY**  
LOOKING NORTH (UPSTATION)

**Addendum No. 01**  
**ID 4085-62-71**  
**Revised Sheet 56**  
**October 4, 2022**

10/3/22  
[Signature]

NO.	DATE	REVISION	BY
1	9/30/22	PER 1 & 2 CORRECT BAR STEEL QUANTITIES	NWR

STATE OF WISCONSIN  
DEPARTMENT OF TRANSPORTATION  
STRUCTURES DESIGN SECTION  
**STRUCTURE B-5-465**

PLANS  
BY D.L.W./NWR/CKD.  
DLM

CROSS SECTION & QUANTITIES  
SHEET 2  
**56**

**ABUTMENT BACKFILL DIAGRAM FOR WINGS PARALLEL TO ROADWAY**

- L = OUT TO OUT OF ABUTMENT, INCLUDING WINGS (FT)
- H = AVERAGE ABUTMENT FILL HEIGHT (FT)
- EP = AVERAGE ABUTMENT FILL PERCENTAGE
- AND L/100 FOR TON ITEMS
- V<sub>cr</sub> = (L/13.0)(H) + (L/10.0)(S)(L/5H)(H)
- V<sub>c</sub> = V<sub>cr</sub> (EP/72)
- V<sub>tot</sub> = V<sub>c</sub> (Ct)

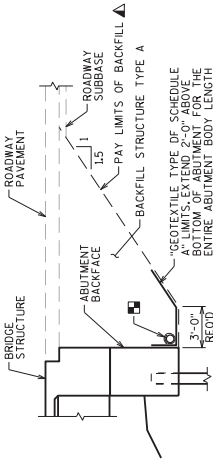

**TYPICAL SECTION THRU ABUTMENT**

- ▲ BACKFILL PAY LIMITS, BEYOND BACKFILL PAY LIMITS SHALL BE INCIDENTAL TO EXCAVATION FOR STRUCTURES. LIMITS OF EXCAVATION SHALL BE DETERMINED BY THE CONTRACTOR.
- PIPE UNDERDRAIN WRAPPED 16 INCH, SLOPE 0.5% MIN. TO SUITABLE DRAINAGE. ATTACH ROBERT SHIELD AT ENDS OF PIPE UNDERDRAIN.

**TOTAL ESTIMATED QUANTITIES**

BID ITEM NUMBER	BID ITEMS	UNIT	SUPER.	SOUTH ABUT.	PIER 1	PIER 2	NORTH ABUT.	TOTALS
203.0220	REMOVING STRUCTURE (B-5-52)	EACH						1
206.0020	EXCAVATION FOR STRUCTURES BRIDGES B-5-465	LS						1
210.1600	BACKFILL STRUCTURE TYPE A	TON		205			225	430
502.0100	CONCRETE MASONRY BRIDGES	CY	324.2	48.7	75.0	75.8	46.9	569.7
502.3200	PROTECTIVE SURFACE TREATMENT	SY	732					732
502.3210	PIGMENTED SURFACE SEALER	SY	241	15			13	269
503.0137	PRESTRESSED GIRDER TYPE I 36-INCH	LF	1180					1180
505.0400	BAR STEEL REINFORCEMENT HS STRUCTURES	LB	2620	2620	3420	3420	2620	12,080
505.0600	BAR STEEL REINFORCEMENT HS COATED STRUCTURES	LB	66,750	3040	22,950	11,760	2,480	95,080
506.2405	BEARING PADS ELASTOMERIC NON-LAMINATED	EACH		5	10	10	5	30
506.4000	STEEL DIAPHRAGMS B-5-465	EACH	16					16
516.0500	RUBBERIZED MEMBRANE WATERPROOFING	SY		10				20
550.0100	PILING STEEL HP 10-INCH X 42 LB	LF		760			720	1480
550.1120	PILING STEEL HP 12-INCH X 53 LB	LF			1120			2240
604.0600	SLOPE PAVING SELECT CRUSHED MATERIAL	SY		320			350	670
612.0406	PIPE UNDERDRAIN WRAPPED 6-INCH	LF		70			70	140
614.0150	ANCHOR ASSEMBLIES FOR STEEL PLATE BEAM GUARD	EACH	4					4
645.0111	GEOTEXTILE TYPE DF SCHEDULE A	SY		24			27	51
SPV.0090	REMOVING EXISTING STEEL PILING	LF		180	150	225	180	735
	NON-BID ITEMS							
	FILLER	SIZE						1/2"

Addendum No. 01  
ID 4085-62-71  
Revised Sheet 57  
October 4, 2022

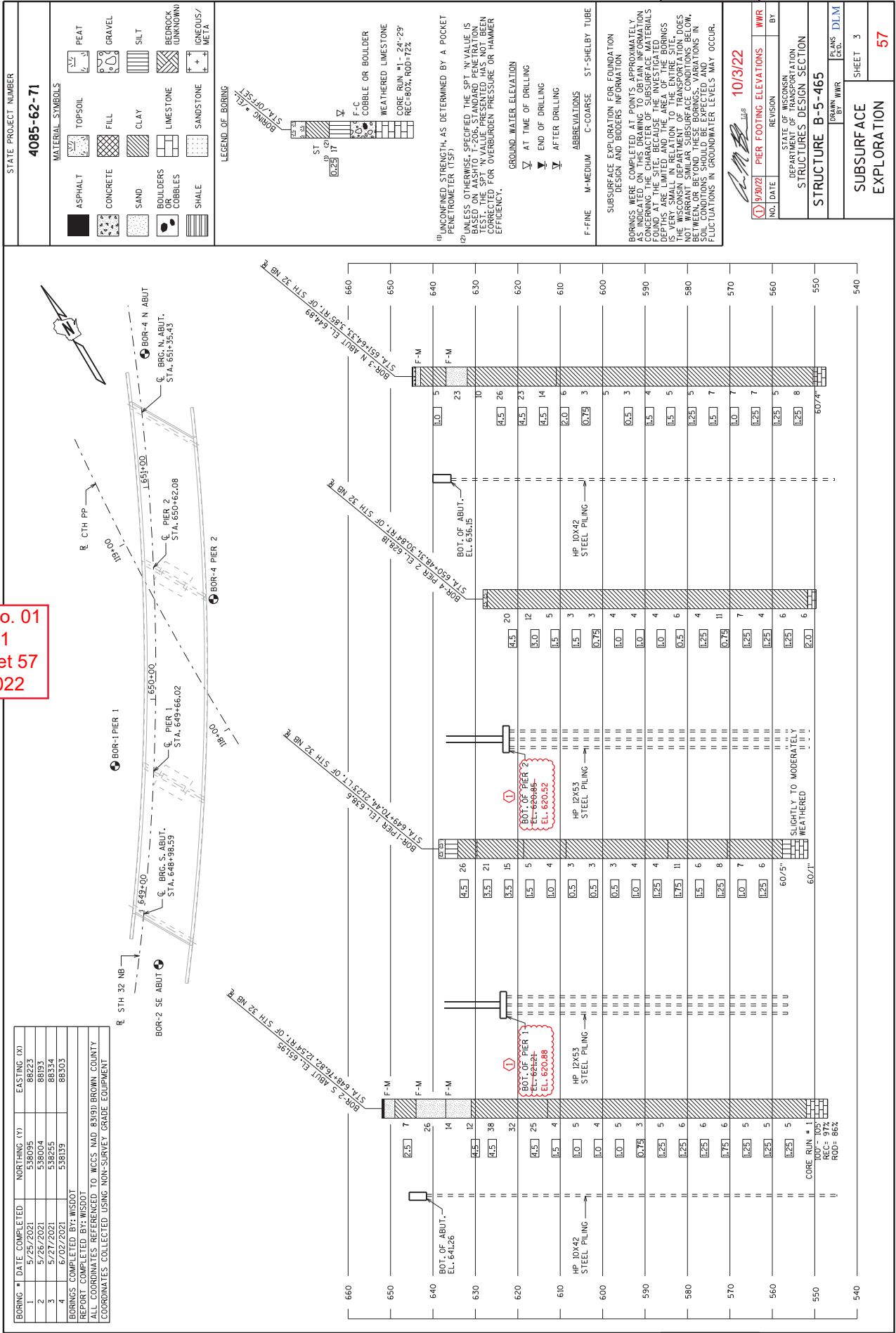



STATE PROJECT NUMBER  
**4085-62-71**

NOTE: THE FIRST OR FIRST TWO DIGITS OF THE BAR MARK SIGNIFIES THE BAR SIZE

**BILL OF BARS**

BAR MARK	NO. RECD.	LENGTH	BENT	BAR SERIES	LOCATION
P501	19	17'-8"			FOOTING-HORIZ. BOT.
P1002	25	13'-8"			FOOTING-HORIZ. BOT.
P603	19	13'-8"			FOOTING-HORIZ. TOP
P604	15	17'-8"			FOOTING-HORIZ. TOP
P1005	X 40	13'-2"	X	13'-6"	FOOTING/SHAFT-VERT.
P406	X 32	7'-5"	X	13'-6"	FOOTING/SHAFT-HORIZ.
P407	X 32	9'-8"	X		FOOTING/SHAFT-HORIZ.
P408	X 19	4'-1"	X		SHAFT-VERT. TIE BARS
P509	X 32	15'-2"	X	▲	CAP-VERT. STIRRUPS
P510	X 32	15'-9"	X	▲	CAP-VERT. STIRRUPS
P611	X 8	18'-1"	X		CAP-HORIZ. BOT.
P612	X 8	18'-8"	X		CAP-HORIZ. BOT.
P613	X 16	22'-4"		▲	CAP-HORIZ. SIDES (LOWER)
P614	X 8	31'-7"		▲	CAP-HORIZ. SIDES (UPPER)
P1015	X 10	34'-9"	X		CAP-HORIZ. TOP
P517	X 15	7'-3"	X		CAP-VERT. U-BAR
P518	X 12	7'-1"	X		CAP-VERT. U-BAR
P519	X 12	2'-0"			CAP-VERT. DOREL
P420	X 30	6'-0"	X		CAP-VERT. U-BAR AT BEAM SEATS
P421	X 4	4'-4"			CAP-HORIZ.-BEAM SEAT 1
P422	X 12	4'-11"			CAP-HORIZ.-BEAM SEAT 2,3,4
P423	X 4	4'-6"		▲	CAP-HORIZ.-BEAM SEAT 5
P624	X 2	6'-6"	X	7'-2"	FOOTING-UP-LIFT BARS
P1025	X 40	19'-6"			SHAFT/CAP-VERT.

▲ LENGTH SHOWN FOR BAR IS AN AVERAGE LENGTH AND SHOULD ONLY BE USED FOR BAR WEIGHT CALCULATIONS. SEE BAR SERIES TABLE FOR ACTUAL LENGTHS.

**BAR SERIES TABLE**

BAR MARK	NO. RECD.	LENGTH
P509	2 SERIES OF 16	12'-3" TO 18'-1"
P510	2 SERIES OF 16	12'-3" TO 19'-3"
P613	2 SERIES OF 8	17'-4" TO 31'-4"

BUNDLE AND TAG EACH SERIES SEPARATELY.

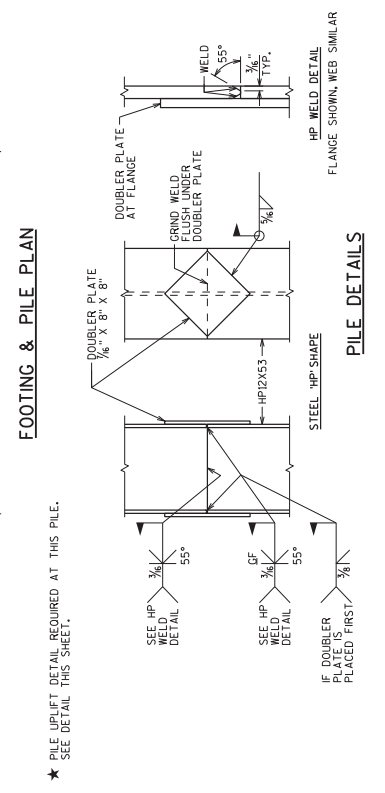
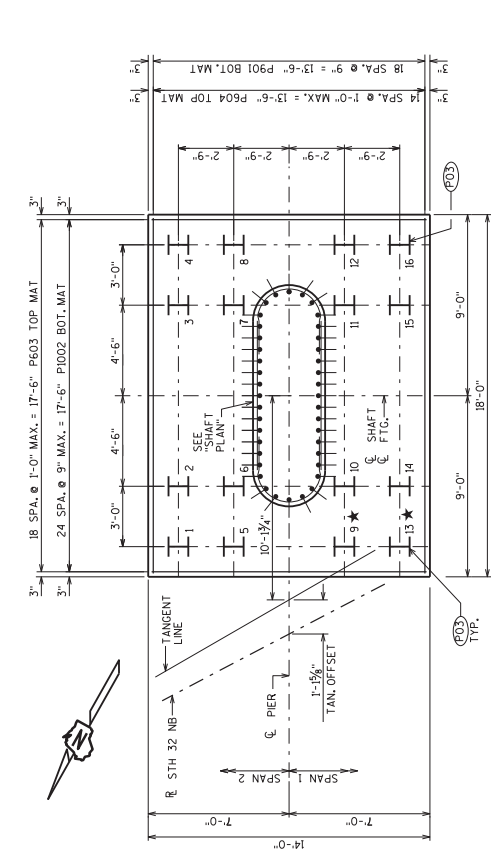
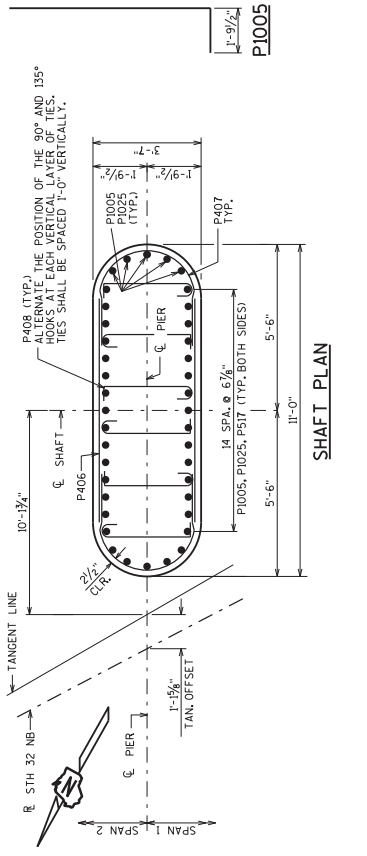
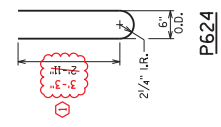
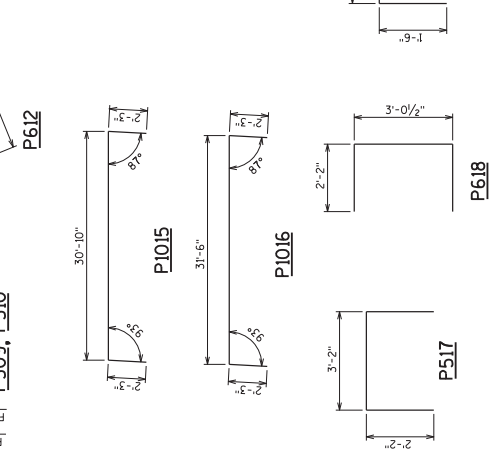
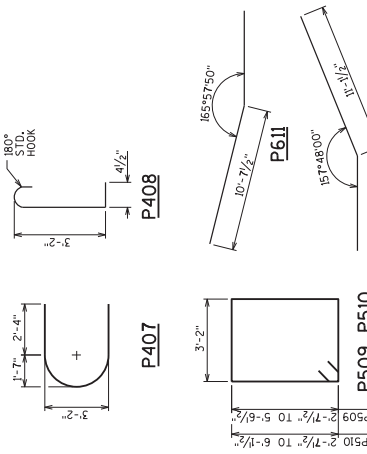

Addendum No. 01  
ID 4085-62-71  
Revised Sheet 65  
October 4, 2022

★ PILE UPLIFT DETAIL REQUIRED AT THIS PILE. SEE DETAIL THIS SHEET.

PIER 1  
DETAILS

65

NO. DATE REVISION BY  
19/01/22 BAR BEND & BAR LENGTHS WWR  
STATE OF WISCONSIN  
DEPARTMENT OF TRANSPORTATION  
STRUCTURES DESIGN SECTION  
STRUCTURE B-5-465  
BY  
PLANS WWR (C.D.) DLM  
SHEET 11

STATE PROJECT NUMBER  
**4085-62-71**

**Addendum No. 01**  
**ID 4085-62-71**  
**Revised Sheet 66**  
**October 4, 2022**

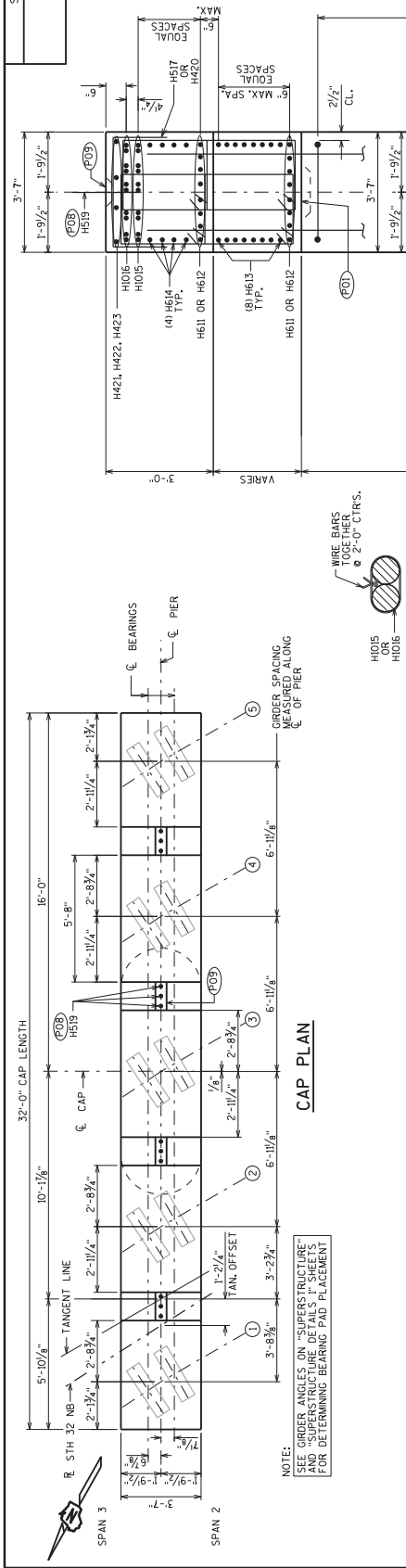

**BUNDLING DETAIL**



**STAR SLOPED BEAM SEAT DETAIL**

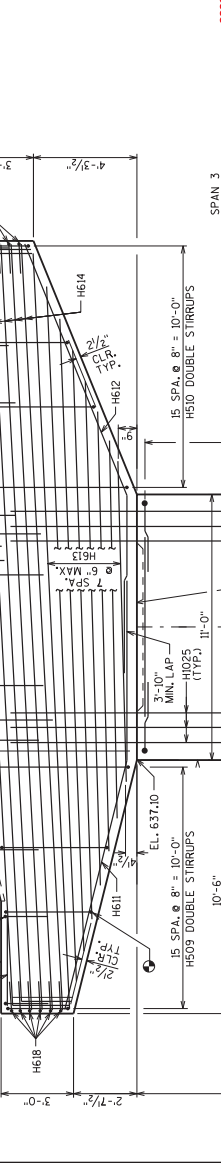

**END VIEW**

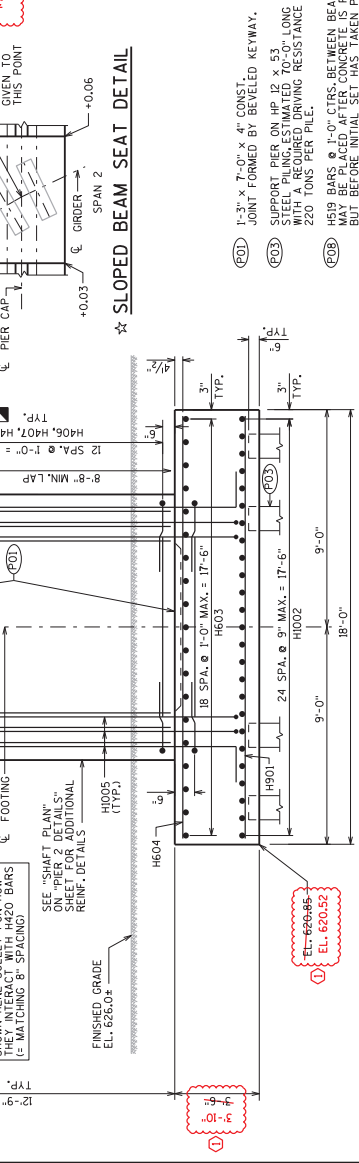

**ELEVATION**



8

8

NO.	DATE	REVISION	BY
19/2022		PIER FOOTING ELEV./DIM.'S	WWR

10/3/22

STATE OF WISCONSIN  
DEPARTMENT OF TRANSPORTATION  
STRUCTURES DESIGN SECTION  
**STRUCTURE B-5-465**

DESIGNED BY	WWR
CHECKED BY	DLM
DATE	10/3/22

SHEET 12  
**66**

1'-3" x 7'-0" x 4" CONST. JOINT FORMED BY BEVELED KEYWAY.

SUPPORT PIER ON HP 12 x 53 CHANNELS WITH A REQUIRED DRIVING RESISTANCE OF 220 TONS PER PILE.

H519 BARS @ 1'-0" CTRS. BETWEEN BEAM SEATS. MAY BE PLACED AFTER CONCRETE IS POURED BUT BEFORE INITIAL SET HAS TAKEN PLACE. (EMBED 1'-0" INTO CONCL.)

KEYED CONST. JOINT FORMED BY BEVELED 2 x 6 BETWEEN BEAM SEATS.

STATE PROJECT NUMBER  
**4085-62-71**

NOTE: THE FIRST OR FIRST TWO DIGITS OF THE BAR MARK SIGNIFIES THE BAR SIZE

**BILL OF BARS**

BAR MARK	NO. RECD.	LENGTH	BENT	BAR SERIES	LOCATION
H901	19	17'-8"			FOOTING-HORIZ. BOT.
H002	25	13'-8"			FOOTING-HORIZ. BOT.
H603	19	13'-8"			FOOTING-HORIZ. TOP
H604	15	17'-8"			FOOTING-HORIZ. TOP
H005	X 40	13'-2"			FOOTING/SHAFT-VERT.
H406	X 28	7'-3"			FOOTING/SHAFT-HORIZ.
H407	X 28	9'-8"			FOOTING/SHAFT-HORIZ.
H408	X 78	4'-1"			SHAFT-HORIZ. TIE BARS
H509	X 32	15'-2"			CAP-VERT. STIRRUPS
H510	X 32	15'-9"			CAP-VERT. STIRRUPS
H611	X 8	18'-1"			CAP-HORIZ. BOT.
H612	X 8	18'-8"			CAP-HORIZ. BOT.
H613	X 16	22'-4"			CAP-HORIZ. SIDES (LOWER)
H614	X 8	31'-7"			CAP-HORIZ. SIDES (UPPER)
H015	X 10	34'-9"			CAP-HORIZ. TOP
H517	X 15	7'-3"			CAP-VERT. U-BAR
H618	X 12	7'-1"			CAP-VERT. END U-BAR
H519	X 12	2'-0"			CAP-VERT. DOREL
H420	X 30	6'-0"			CAP-VERT. U-BAR AT BEAM SEATS
H421	X 4	4'-6"			CAP-HORIZ.-BEAM SEAT 1
H422	X 12	5'-4"			CAP-HORIZ.-BEAM SEAT 2,3,4
H423	X 4	4'-9"			CAP-HORIZ.-BEAM SEAT 5
H624	X 2	6'-6"			FOOTING-UP-LIFT BARS
H025	X 40	17'-9"			SHAFT/CAP-VERT.

▲ LENGTH SHOWN FOR BAR IS AN AVERAGE LENGTH AND SHOULD ONLY BE USED FOR BAR WEIGHT CALCULATIONS. SEE BAR SERIES TABLE FOR ACTUAL LENGTHS.

**BAR SERIES TABLE**

BAR MARK	NO. RECD.	LENGTH
H509	2	SERIES 2 OF 18
H510	2	SERIES 2 OF 18
H613	2	SERIES 2 OF 8

BUNDLE AND TAG EACH SERIES SEPARATELY.

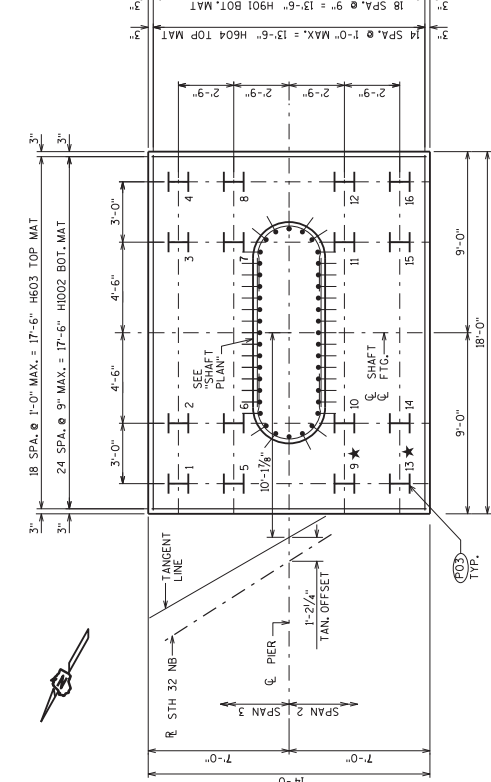
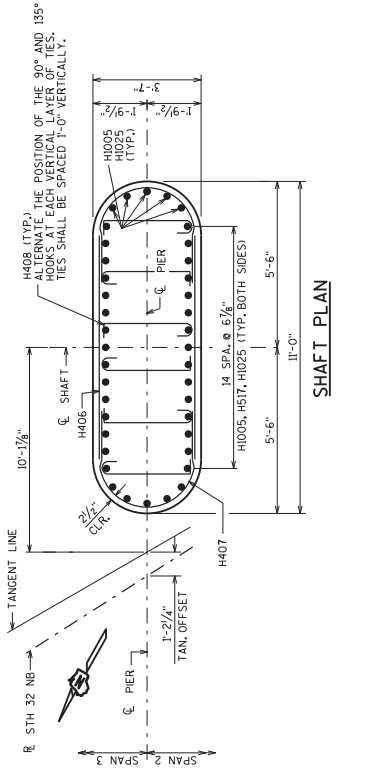
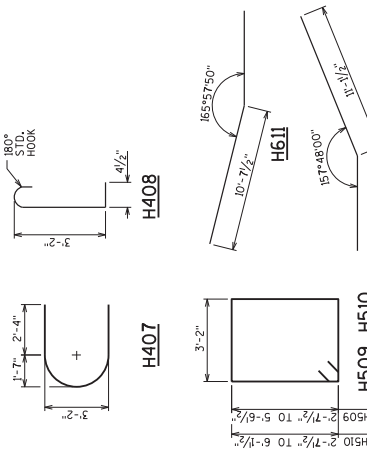

**FOOTING & PILE PLAN**

★ PILE UPLIFT DETAIL REQUIRED AT THIS PILE. SEE DETAIL THIS SHEET.

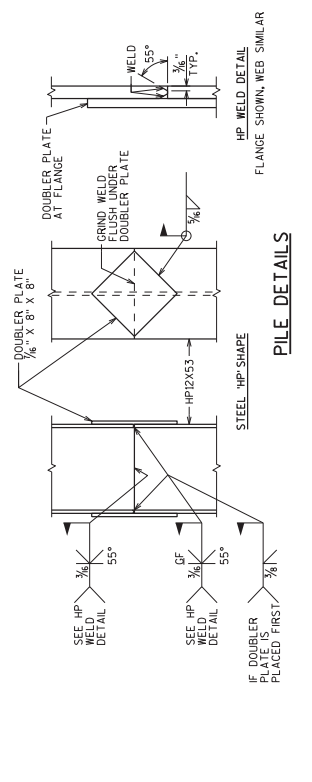

**PILE DETAILS**

10/3/22

① SUPPORT PIER ON HP 12 X 53 STEEL PILING, ESTIMATED 70'-0" LONG WITH A REQUIRED DRIVING RESISTANCE OF 220 TONS PER PILE.

NO. DATE	REVISION	BY
① 9/20/22	BAR BEND & BAR LENGTHS	RWR

STATE OF WISCONSIN  
DEPARTMENT OF TRANSPORTATION  
STRUCTURES DESIGN SECTION

STRUCTURE B-5-465

DESIGNER	PLANS	DLM
BY	WWR	CKD

PIER 2  
DETAILS

SHEET 13  
**67**

Addendum No. 01  
ID 4085-62-71  
Revised Sheet 67  
October 4, 2022



## Proposal Schedule of Items

Proposal ID: 20221011004 Project(s): 4085-62-71

Federal ID(s): WISC 2023005

SECTION: 0001

Contract Items

Alt Set ID:

Alt Mbr ID:

Proposal Line Number	Item ID Description	Approximate Quantity and Units	Unit Price	Bid Amount
0034	416.1010 Concrete Surface Drains	13.000 CY	_____.	_____.
0036	455.0605 Tack Coat	25.000 GAL	_____.	_____.
0038	460.2000 Incentive Density HMA Pavement	550.000 DOL	1.00000	550.00
0040	460.6223 HMA Pavement 3 MT 58-28 S	72.000 TON	_____.	_____.
0042	460.6224 HMA Pavement 4 MT 58-28 S	24.000 TON	_____.	_____.
0044	502.0100 Concrete Masonry Bridges	574.000 CY	_____.	_____.
0046	502.3200 Protective Surface Treatment	732.000 SY	_____.	_____.
0048	502.3210 Pigmented Surface Sealer	269.000 SY	_____.	_____.
0050	503.0137 Prestressed Girder Type I 36W-Inch	1,180.000 LF	_____.	_____.
0052	505.0400 Bar Steel Reinforcement HS Structures	12,080.000 LB	_____.	_____.
0054	505.0600 Bar Steel Reinforcement HS Coated Structures	96,200.000 LB	_____.	_____.
0056	506.2605 Bearing Pads Elastomeric Non-Laminated	30.000 EACH	_____.	_____.
0058	506.4000 Steel Diaphragms (structure) 01. B-05-465	16.000 EACH	_____.	_____.
0060	516.0500 Rubberized Membrane Waterproofing	20.000 SY	_____.	_____.
0062	550.1100 Piling Steel HP 10-Inch X 42 Lb	1,480.000 LF	_____.	_____.
0064	550.1120 Piling Steel HP 12-Inch X 53 Lb	2,240.000 LF	_____.	_____.







# Wisconsin Department of Transportation

## Division of Transportation Systems Development

Bureau of Project Development  
4822 Madison Yards Way, 4<sup>th</sup> Floor South  
Madison, WI 53705

October 6, 2022

Telephone: (608) 266-1631  
Facsimile (FAX): (608) 266-8459

### NOTICE TO ALL CONTRACTORS:

**Proposal #04: 4085-62-71, WISC 2023005**  
**City of De Pere, Greenleaf Road**  
**STH 32 Northbound over CTH PP**  
**STH 32**  
**Brown County**

### Letting of October 11, 2022

This is Addendum No. 02, which provides for the following:

#### Schedule of Items:

Revised Bid Item Quantities					
Bid Item	Item Description	Unit	Old Quantity	Revised Quantity	Proposal Total
204.0150	Removing Curb & Gutter	LF	101	60	161

Added Bid Item Quantities					
Bid Item	Item Description	Unit	Old Quantity	Revised Quantity	Proposal Total
416.0610	Drilled Tie Bars	EACH	0	20	20
416.0620	Drilled Dowel Bars	EACH	0	16	16
416.1720	Concrete Pavement Replacement	SY	0	60	60
601.0409	Concrete Curb & Gutter 30-Inch Type A	LF	0	60	60

#### Plan Sheets:

Revised Plan Sheets	
Plan Sheet	Plan Sheet Title (brief description of changes to sheet)
15	Miscellaneous Quantities – Updated quantities in Removals table
16	Miscellaneous Quantities – Updated items and quantities in Pavement and Curb & Gutter tables
20	Plan Sheets – Added callout noting removal and replacement of existing curb & gutter and shoulder on CTH PP
22	Standard Detail Drawing 08D01
29	Standard Detail Drawing 13C09

**Schedule of Items**

Attached, dated October 6, 2022, are the revised Schedule of Items Pages 1 - 6.

**Plan Sheets**

The following 8½ x 11-inch sheets are attached and made part of the plans for this proposal:

Revised: 15, 16, and 20.

Added: 24A, 24B, 27A – 27C.

The responsibility for notifying potential subcontractors and suppliers of these changes remains with the prime contractor.

Sincerely,

*Mike Coleman*

Proposal Development Specialist  
Proposal Management Section

END OF ADDENDUM

**Addendum No. 02**  
**ID 4085-62-71**  
**Revised Sheet 15**  
**October 6, 2022**

DIVISION	FROM/TO STATION	LOCATION	COMMON EXCAVATION (1)		SALVAGED/UNUSABLE PAVEMENT MATERIAL (4)	AVAILABLE MATERIAL (5)	UNEXPANDED FILL	EXPANDED FILL (13)		WASTE	208.0100 BORROW	COMMENT
			CUT (2)	EBS EXCAVATION (3)				FACTOR 1.15	MASS ORDINATE +/- (14)			
DIVISION 1	645+06 - 646+75	EAT GRADING	59	0	0	59	66	76	-17			
			59	0	0	59	66	76	-17			
			59	0	0	59	66	76	-17	0	17	
TOTAL COMMON EXC			59	0	0	59	66	76	-17	0	17	

REMOVALS

STATION	TO	STATION	LOCATION	SY	LF	204.0100 REMOVING CONCRETE PAVEMENT	204.0150 REMOVING CURB & GUTTER	204.0165 REMOVING GUARDRAIL	204.0190 REMOVING SURFACE DRAINS
639+08	-	648+86	STH32	-	63	1,251	2		
651+47	-	652+17	STH32	120	38	71	1		
117+68	-	118+28	CTHPP	-	60	-	-		
PROJECT TOTAL					120	161	3		

GUARDRAIL

STATION	TO	STATION	LOCATION	MGS GUARDRAIL BEAM TRANSITION	LF	MGS GUARDRAIL TERMINAL	TYPE	EACH	614.2500	614.2610	614.2620
638+97	-	648+75	STH32, RIGHT	48	937	-	-	-			
645+62	-	648+92	STH32, LEFT	39	237	1	-	-			
651+35	-	652+29	STH32, RIGHT	50	40	-	1	-			
651+55	-	652+37	STH32, LEFT	40	37	-	1	-			
PROJECT TOTAL					177	1,251	1	2			

MISC

STATION	TO	STATION	LOCATION	FIELD OFFICE TYPEB	EACH	619.1000 MOBILIZATION	EACH	642.5001	619.1000	642.5001	619.1000	642.5001
			STH32	1	1	1,200						
PROJECT TOTAL					1	1	1,200					

Addendum No. 02  
ID 4085-62-71  
Revised Sheet 16  
October 6, 2022

**BASE/AGGREGATE**

STATION	TO	STATION	LOCATION	BASE/AGGREGATE DENSE 3/4-INCH TON	BASE/AGGREGATE DENSE 1 1/4-INCH TON	BASE/AGGREGATE DENSE 3-INCH TON	624.0100	REMARKS
648+77	-	648+99	5TH 32	-	13	-	0.2	CONCRETE APPROACH SLAB
651+29	-	651+56	5TH 32	42	98	217	0.2	CONCRETE APPROACH SLAB
648+27	-	648+77	5TH 32	27	82	186	5.4	
651+56	-	652+05	5TH 32	-	-	-	4.4	
PROJECT TOTAL				70	209	404	11	

**PAVEMENT ITEMS**

STATION	TO	STATION	LOCATION	PAVEMENT ITEMS	QUANTITY	UNIT	REMARKS
213.0100.01	415.0410	415.0410	FINISHING ROADWAY (PROJECT) 01. 4085-62-71)	CONCRETE PAVEMENT APPROACH SLAB	415.0410	SY	
416.0610	416.0620	416.1720	CONCRETE PAVEMENT REPLACEMENT	CONCRETE PAVEMENT REPLACEMENT	416.1720	SY	
416.0610	416.0620	416.1720	DRILLED DOWEL BARS	DRILLED DOWEL BARS	416.0620	EACH	
416.0610	416.0620	416.1720	DRILLED TIE BARS	DRILLED TIE BARS	416.0620	EACH	
416.0610	416.0620	416.1720	TACK COAT	TACK COAT	455.0605	GAL	
416.0610	416.0620	416.1720	HMA PAVEMENT	HMA PAVEMENT	460.6223	TON	
416.0610	416.0620	416.1720	HMA PAVEMENT	HMA PAVEMENT	460.6224	TON	
PROJECT TOTAL					70		

**CURB & GUTTER**

STATION	TO	STATION	LOCATION	CURB & GUTTER	QUANTITY	UNIT	REMARKS
601.0409	601.0588	601.0588	CONCRETE CURB & GUTTER 4-INCH TYPE A	CONCRETE CURB & GUTTER 4-INCH TYPE A	60	LF	
601.0409	601.0588	601.0588	CONCRETE CURB & GUTTER 36-INCH SLOPED 36-INCH TYPE B/T	CONCRETE CURB & GUTTER 36-INCH SLOPED 36-INCH TYPE B/T	101	LF	
639+07	639+21	639+21	5TH 32 RT	CONCRETE APPROACH SLAB	37	LF	
648+72	648+86	648+86	5TH 32 LT	CONCRETE APPROACH SLAB	480	LF	
651+62	651+76	651+76	5TH 32 LT	CONCRETE APPROACH SLAB	42	LF	
117+68	118+28	118+28	CTH PP	CONCRETE APPROACH SLAB	559	LF	
PROJECT TOTAL					60		

**PAVEMENT MARKINGS**

STATION	TO	STATION	LOCATION	PAVEMENT MARKINGS	QUANTITY	UNIT	REMARKS
646.1020	646.1020	646.1020	MARKING LINE	MARKING LINE	646.1020	LF	
646.1020	646.1020	646.1020	EPOXY 4-INCH	EPOXY 4-INCH	646.1020	LF	
648+99	648+99	648+99	5TH 32	CONCRETE APPROACH SLAB	37	LF	
651+29	651+29	651+29	5TH 32	CONCRETE APPROACH SLAB	480	LF	
651+29	651+56	651+56	5TH 32	CONCRETE APPROACH SLAB	42	LF	
PROJECT TOTAL					559		

PROJECT NO: 4085-62-71

HWY: STH 32

COUNTY: BROWN

MISCELLANEOUS QUANTITIES

SHEET: 16

E

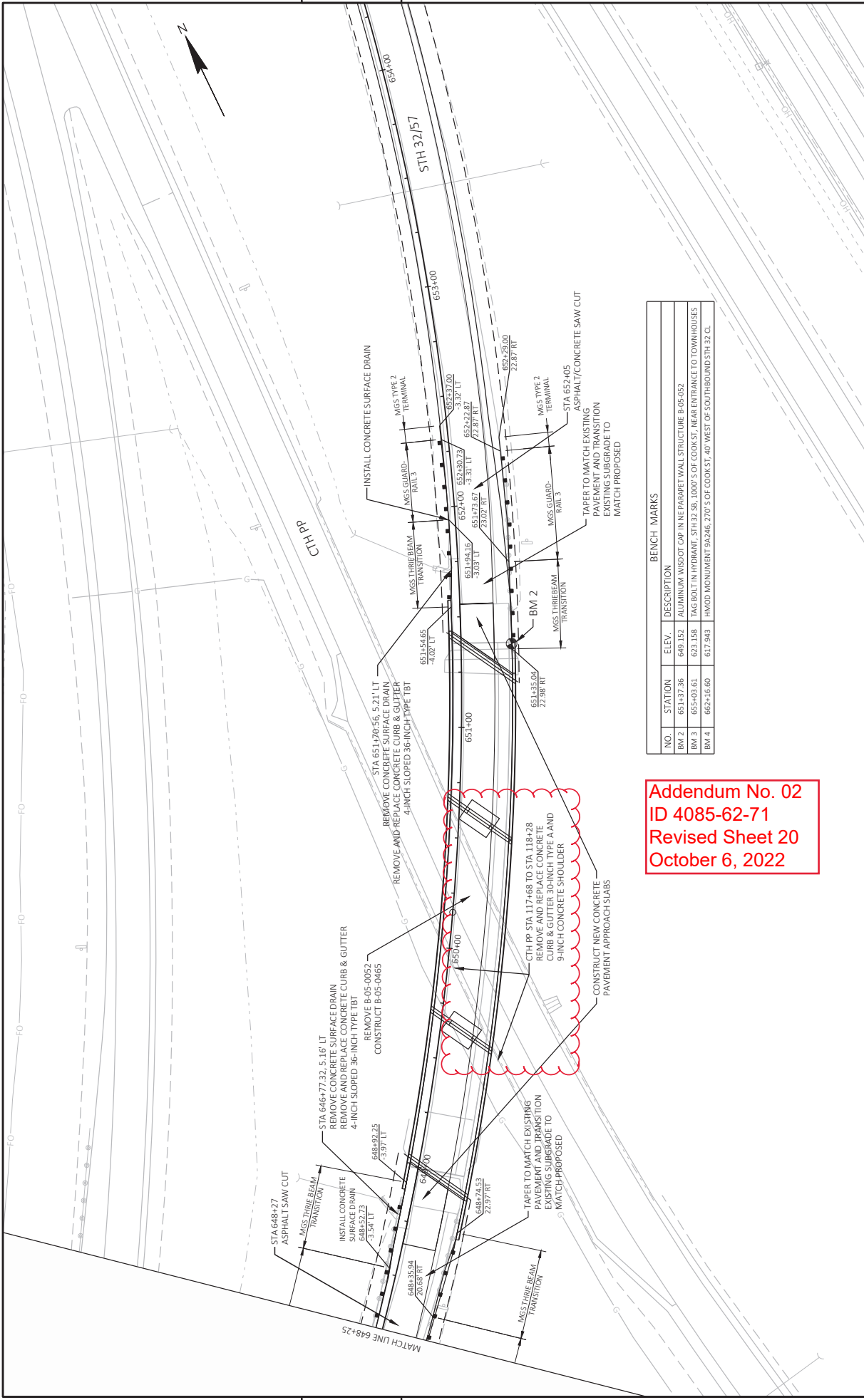

NO.	STATION	ELEV.	DESCRIPTION
BM 2	651+37.36	649.152	ALUMINUM WISDOT CAP IN NE PARAPET WALL STRUCTURE B-05-052
BM 3	655+03.61	623.156	TAG BOLT IN HYDRANT, STH 32 SB, 1000.5 OF COOK ST, NEAR ENTRANCE TO TOWNHOUSES
BM 4	662+16.60	617.943	HMDD MONUMENT 9A246, 270.5 OF COOK ST, 40' WEST OF SOUTHBOUND STH 32 CL

Addendum No. 02  
 ID 4085-62-71  
 Revised Sheet 20  
 October 6, 2022

**GENERAL NOTES**

DETAILS OF CONSTRUCTION AND WORKMANSHIP NOT SHOWN ON THIS DRAWING SHALL CONFORM TO THE PERTINENT REQUIREMENTS OF THE CONTRACT.  
 PAVEMENT TIES AND TIE BARS SHALL BE EPOXY COATED IN CONFORMANCE WITH SUBSECTION 505.2.6.2 OF THE STANDARD SPECIFICATIONS.  
 INTEGRAL CURB AND GUTTER SHALL CONFORM TO THE DETAILS SHOWN FOR CONCRETE CURB AND GUTTER INCLUDING THE TRANSVERSE GUTTER SLOPE.  
 UNLESS OTHERWISE SHOWN ON THE TYPICAL CROSS SECTIONS, THE BASE AGGREGATE AND COMMON EXCAVATION LIMITS ARE 2'-0" BEHIND THE BACK OF CURBS.

- ① TIE BARS ARE REQUIRED FOR CURB AND GUTTERS TYPES A, G, K, R, AND TBTT.
- ② THE BOTTOM OF CURB AND GUTTER MAY BE CONSTRUCTED EITHER LEVEL OR PARALLEL TO THE SLOPE OF THE SUBGRADE OR BASE AGGREGATE PROVIDED A 6" MINIMUM GUTTER THICKNESS IS MAINTAINED.
- ③ USE 6" MINIMUM GUTTER THICKNESS WHEN USED WITH AN ADJACENT CONCRETE TRUCK APRON PLACED BEHIND BACK OF CURB.
- ④ THE BOTTOM OF CURB AND GUTTER MAY BE CONSTRUCTED EITHER LEVEL OR PARALLEL TO THE SLOPE OF THE SUBGRADE OR BASE AGGREGATE PROVIDED A 6" MINIMUM GUTTER THICKNESS IS MAINTAINED.
- ⑤ UNLESS OTHERWISE NOTED, FOR STAKING PURPOSES THE FACE OF CURB IS 6" FROM THE BACK OF CURB.
- ⑥ WHEN REVERSE SLOPE GUTTER IS REQUIRED, THE LOCATION(S) WILL BE SHOWN ELSEWHERE IN THE PLAN.
- ⑦ USE 4% GUTTER CROSS SLOPE UNLESS OTHERWISE NOTED IN THE PLANS.
- ⑧ INCLUDE LONGITUDINAL JOINT AND TIE BARS ALONG LANE EDGE WHEN CONCRETE PANEL WIDTH EXCEEDS 12 FEET. LONGITUDINAL JOINTS AND TIE BARS IN TRAFFIC LANE(S) ARE NOT ALLOWED WITHIN TRAFFIC LINES AND BIKE LANES. LONGITUDINAL JOINT MAY BE SAWED.
- ⑨ CONCRETE CURB AND GUTTER 4-INCH SLOPED 30-INCH TYPE "R" AND "T" = 17 INCHES  
 CONCRETE CURB AND GUTTER 4-INCH SLOPED 36-INCH TYPE "R" AND "T" = 23 INCHES

Addendum No. 02  
 ID 4085-62-71  
 Added Sheet 24A  
 October 6, 2022

**CONCRETE CURB AND GUTTER**  
 STATE OF WISCONSIN  
 DEPARTMENT OF TRANSPORTATION

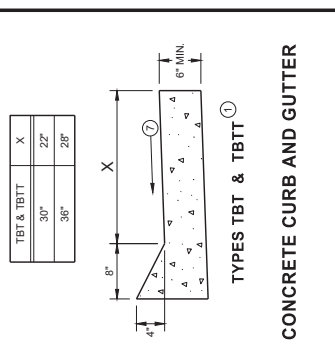

**CONCRETE CURB AND GUTTER**

**PAVEMENT THICKNESS AND MAXIMUM CONCRETE PANEL WIDTH TABLE**

PAVEMENT THICKNESS	MAXIMUM PANEL WIDTH
LESS THAN 10"	12'
10" & ABOVE	15'

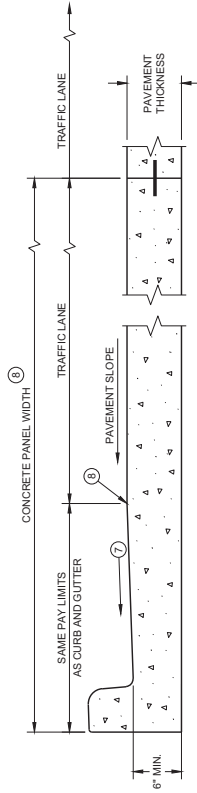

**PARTIAL SECTION OF PAVEMENT \* WITH INTEGRAL CURB AND GUTTER**

\* BIKE LANE IS NOT SHOWN

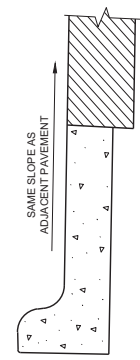

**REVERSE SLOPE GUTTER**  
 (TYPICAL FOR ALL CURB & GUTTER TYPES)

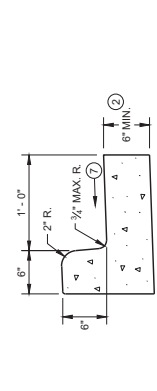

**CONCRETE CURB AND GUTTER 18"**

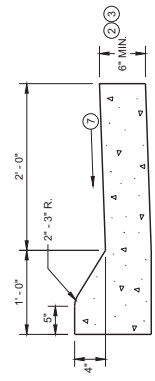
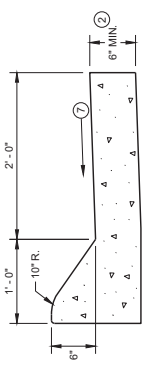

**CONCRETE CURB AND GUTTER 36"**

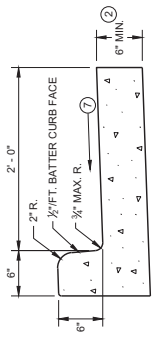
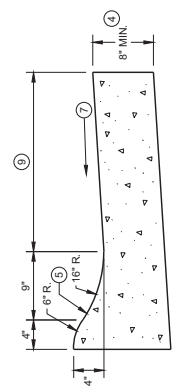

**CONCRETE CURB AND GUTTER 30"**

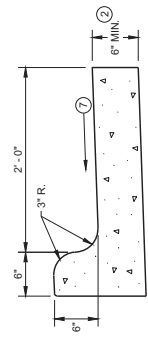
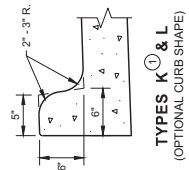
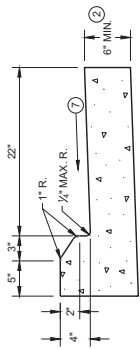
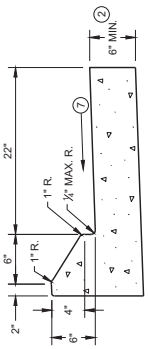

**CONCRETE CURB AND GUTTER 30"**

**GENERAL NOTES**

- DETAILS OF CONSTRUCTION AND WORKMANSHIP NOT SHOWN ON THIS DRAWING SHALL CONFORM TO THE PERTINENT REQUIREMENTS OF THE CONTRACT.
- PAVEMENT TIES AND TIE BARS SHALL BE EPOXY COATED IN CONFORMANCE WITH SUBSECTION 602.62 OF THE STANDARD SPECIFICATIONS.
- UNLESS OTHERWISE SHOWN ON THE TYPICAL CROSS SECTIONS, THE BASE AGGREGATE AND COMMON EXCAVATION LIMITS ARE 2'-0" BEHIND THE BACK OF CURBS.
- TIE BARS ARE REQUIRED FOR CURB AND GUTTERS TYPES A, G, K, R, AND TBT.
- THE BOTTOM OF CURB AND GUTTER MAY BE CONSTRUCTED EITHER LEVEL OR PARALLEL TO THE SLOPE OF THE SUBGRADE OR BASE AGGREGATE PROVIDED A 6" MINIMUM GUTTER THICKNESS IS MAINTAINED.
- REFER TO SDD 08D16 AND 08D19 FOR ADDITIONAL DRIVEWAY ENTRANCE CURB DETAILS.

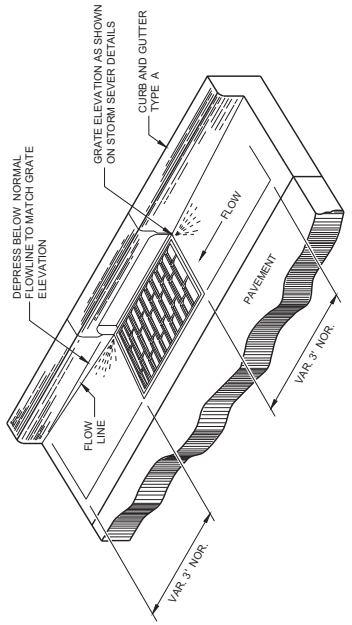

**END SECTION CURB AND GUTTER**

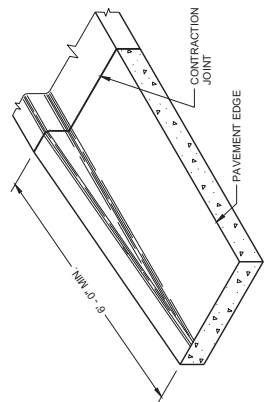

**DETAIL OF CURB AND GUTTER AT INLETS**  
(TYPICAL H INLET COVER SHOWN)

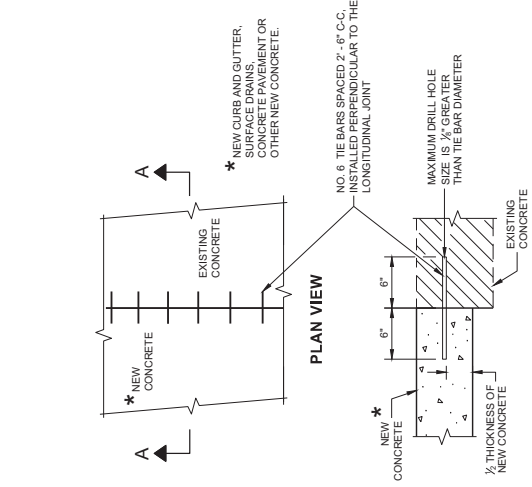

**TIE BARS DRILLED INTO EXISTING PAVEMENT**

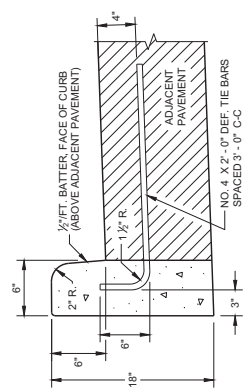

**TYPES A, D & J**

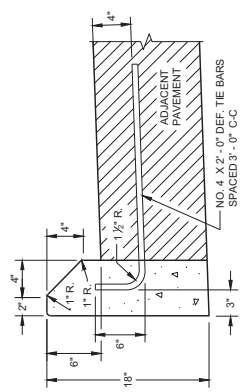

**TYPES G & J**

**CONCRETE CURB**

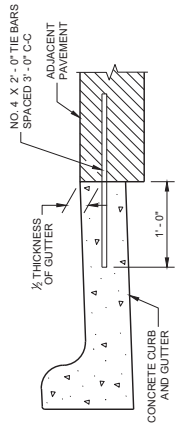

**TYPICAL TIE BAR LOCATION**

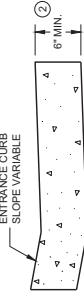

**DRIVEWAY ENTRANCE CURB**  
(WHEN DIRECTED BY THE ENGINEER)

**Addendum No. 02**  
**ID 4085-62-71**  
**Added Sheet 24B**  
**October 6, 2022**

<b>CONCRETE CURB, TIES AND CURB AND GUTTER APPLICATIONS</b>
STATE OF WISCONSIN DEPARTMENT OF TRANSPORTATION
APPROVED February 2021 DATE ROADWAY STRUCTURE DEVELOPMENT ENGINEER

**GENERAL NOTES**

SAW CUT, DRILL, AND LIFT OUT EXISTING CONCRETE PAVEMENT WITHIN THE BOUNDARIES OF CONCRETE REPAIR AREAS. THE CONTRACTOR MAY MAKE ADDITIONAL SAW CUTS INSIDE THE REPAIR LIMITS TO REDUCE WEIGHT AND SIZE OF CONCRETE PIECES.

PROVIDE A 6 FOOT MINIMUM DISTANCE FROM BOUNDARIES OF CONCRETE REPAIR AREA TO ADJACENT TRANSVERSE JOINT OR CRACK.

THE LENGTH OF THE REPAIRS MAY VARY FROM THE DIMENSIONS SHOWN IF THE EXISTING CONCRETE PAVEMENT IS NON-DOWELED AND THE PAVEMENT IS TO BE OVERLAID AFTER REPAIRING.

① DOWEL BARS MAY NOT BE PRESENT.

Addendum No. 02  
ID 4085-62-71  
Added Sheet 27A  
October 6, 2022

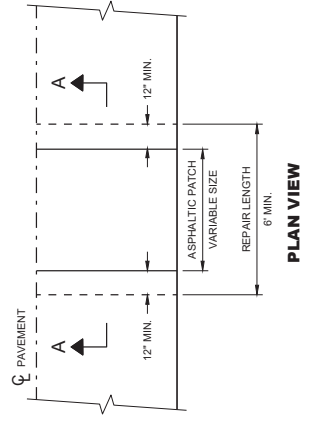
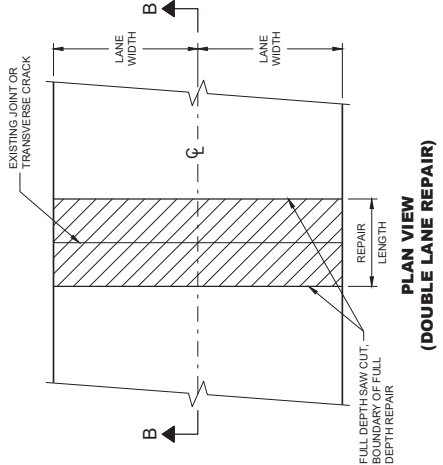
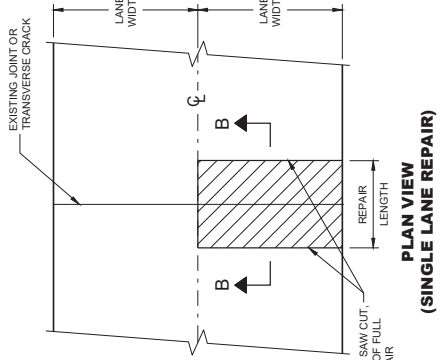

**FULL DEPTH CONCRETE PAVEMENT REMOVAL**

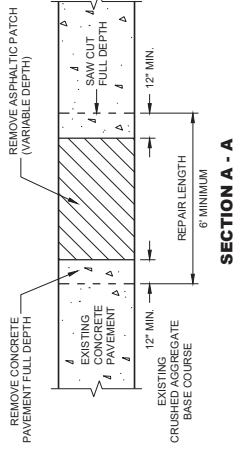
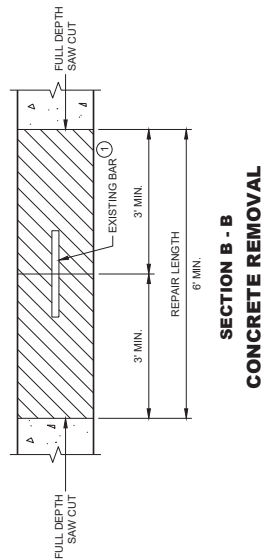

**CONCRETE PAVEMENT  
REPAIR AND REPLACEMENT**

STATE OF WISCONSIN  
DEPARTMENT OF TRANSPORTATION



**GENERAL NOTES**

- INSTALL DOWEL BARS PARALLEL TO THE PAVEMENT CENTERLINE AND PAVEMENT SURFACE.
- CONCRETE REPAIRS OF EXISTING NON-DOWELED CONCRETE PAVEMENTS DO NOT NEED TO BE DOWELED.
- ANCHOR DOWEL BARS AND TIE BARS INTO DRILLED HOLES WITH AN EPOXY. FOR MULTILANE CONCRETE PAVEMENT REPLACEMENTS, PROVIDE A MINIMUM DISTANCE OF 15 INCHES FROM ALL TRANSVERSE JOINTS OR EDGES OF REPLACEMENT TO THE CENTER OF THE TIE BAR NEAREST THAT JOINT OR EDGE.
- APPLY A THIN UNIFORM COATING OF SURFACE TREATMENT TO THE FREE END OF DOWEL BARS TO PREVENT BONDING.

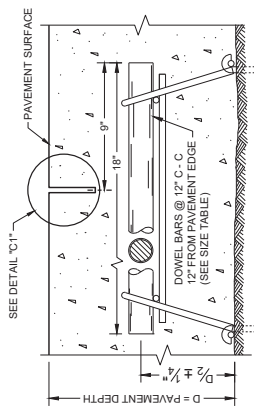

**SECTION F - F**  
DOWELED CONTRACTION JOINT

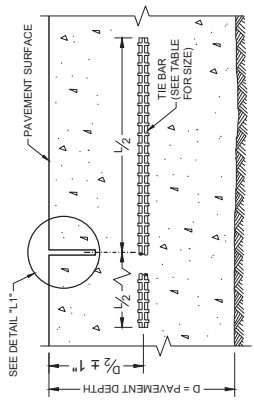

**SECTION C - C**  
SAWED LONGITUDINAL JOINT

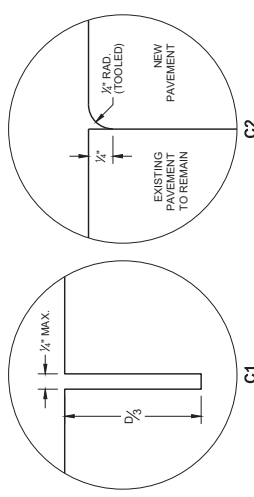

**TRANSVERSE JOINTS**

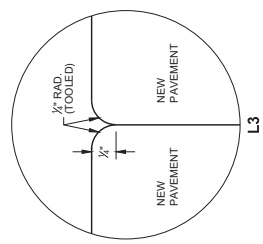

**LONGITUDINAL JOINTS**

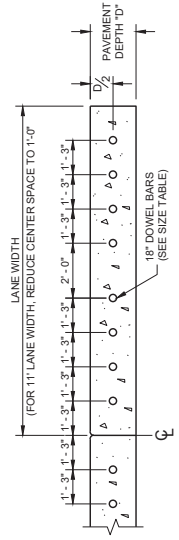

**SECTION E - E**  
DRILLED DOWEL BAR CONSTRUCTION JOINT

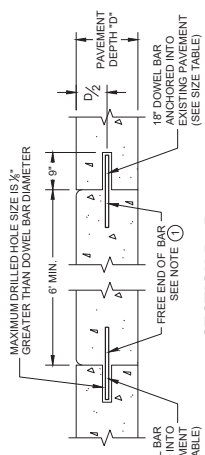

**SECTION D - D**

**TIE BAR TABLE**

PAVEMENT DEPTH (D)	TIE BAR SIZE	TIE BAR LENGTH (L)	MAX. TIE BAR SPACING
< 10 1/2"	NO. 4	30"	36"
≥ 10 1/2"	NO. 5	36"	36"
	NO. 4*	30"	24**

\* SUBSTITUTE BENT BARS AT LONGITUDINAL JOINTS WHEN EQUIPMENT LIMITATIONS DURING CONSTRUCTION WARRANT (e.g. AUXILIARY LANES OR TURN LANES).  
 \*\* CONFORM TO 15' MINIMUM SPACING FROM TRANSVERSE JOINTS; SPACING BETWEEN TIE BARS WILL BE 30' AT TRANSVERSE JOINTS.

**PAVEMENT DEPTH, DOWEL BAR SIZE AND JOINT SPACING TABLE**

PAVEMENT DEPTH (D)	DOWEL BAR DIAMETER	DRILLED DOWEL BAR DIAMETER	CONTRACTION JOINT SPACING
5 1/2" to 6 1/2"	NONE	NONE	12'
7 to 7 1/2"	1"	1"	14'
8" to 8 1/2"	1 1/4"	1 1/4"	15'
9" & ABOVE	1 1/2"	1 1/2"	15'

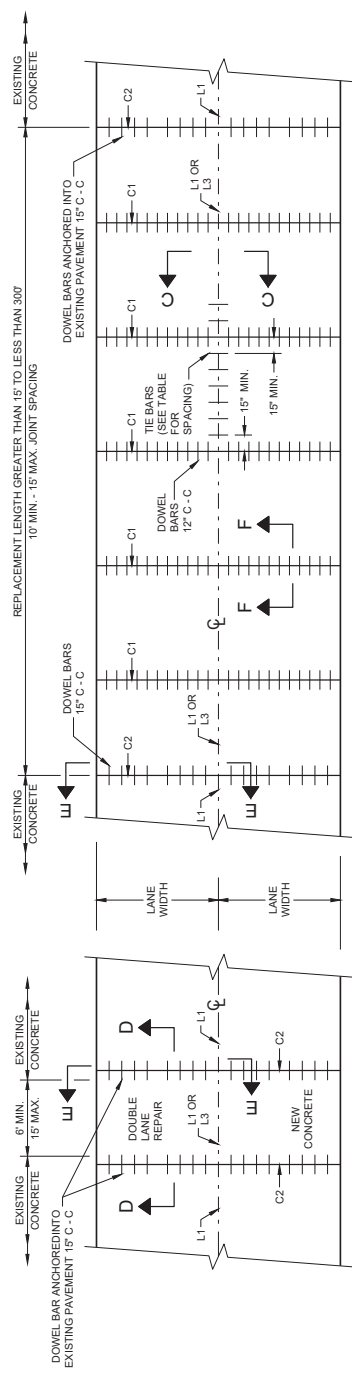

**PLAN VIEW**  
MULTILANE CONCRETE PAVEMENT REPAIR

**PLAN VIEW**  
MULTILANE CONCRETE PAVEMENT REPLACEMENT

Addendum No. 02  
 ID 4085-62-71  
 Added Sheet 27B  
 October 6, 2022

**CONCRETE PAVEMENT REPAIR AND REPLACEMENT**  
 STATE OF WISCONSIN  
 DEPARTMENT OF TRANSPORTATION

Addendum No. 02  
 ID 4085-62-71  
 Added Sheet 27C  
 October 6, 2022

**GENERAL NOTES**

- ① WITH THE APPROVAL OF THE ENGINEER, FOR SINGLE LANE PAVEMENT REPLACEMENTS LESS THAN 30 FEET IN LENGTH, THE CONTRACTOR MAY INSTALL DRILLED TIE BARS ON THE LONGITUDINAL JOINTS OF THE REPLACEMENT PAVEMENT. THE TIE BARS SHALL BE 1/2" DIA. BARS DRIVEN INTO THE EXISTING PAVEMENT TO A DEPTH OF 6 INCHES IN A HOLE OF SUCH A DIAMETER AS TO PROVIDE A TIGHT DRIVEN FIT.
- ② USE AN ENGINEER APPROVED BOND BREAKER (E.G. RELEASE AGENT, CURING COMPOUND) FOR SINGLE LANE REPAIRS UP TO 15 FEET IN LENGTH.
- ③ ANCHOR THE BARS INTO DRILLED HOLES WITH AN EPOXY.

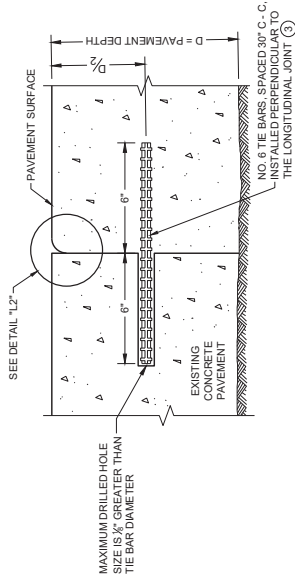

**SECTION G - G**  
**TIE BARS ANCHORED INTO EXISTING PAVEMENT**

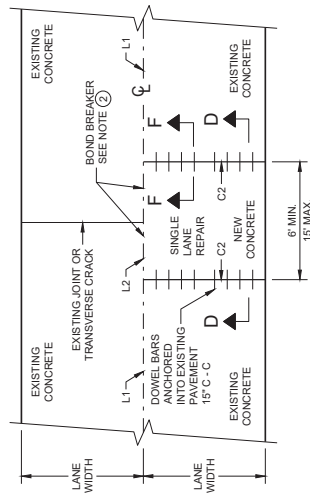

**PLAN VIEW**  
**SINGLE LANE CONCRETE PAVEMENT REPAIR**

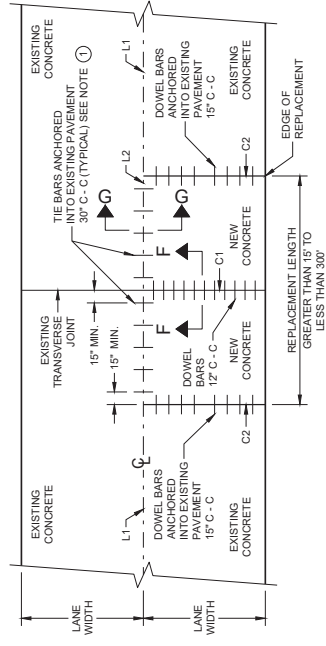

**PLAN VIEW**  
**SINGLE LANE CONCRETE PAVEMENT REPLACEMENT**

<b>CONCRETE REPAIR AND REPLACEMENT</b>
STATE OF WISCONSIN DEPARTMENT OF TRANSPORTATION
APPROVED _____ /S/ Peter Keith P.E. DATE: May 2022 PAVEMENT SUPERVISOR



## Proposal Schedule of Items

Proposal ID: 20221011004 Project(s): 4085-62-71

Federal ID(s): WISC 2023005

SECTION: 0001

Contract Items

Alt Set ID:

Alt Mbr ID:

Proposal Line Number	Item ID Description	Approximate Quantity and Units	Unit Price	Bid Amount
0002	201.0120 Clearing	5.000 ID	_____.	_____.
0004	201.0220 Grubbing	5.000 ID	_____.	_____.
0006	203.0220 Removing Structure (structure) 01. B-05-052	1.000 EACH	_____.	_____.
0008	204.0100 Removing Concrete Pavement	120.000 SY	_____.	_____.
0010	204.0150 Removing Curb & Gutter	161.000 LF	_____.	_____.
0012	204.0165 Removing Guardrail	1,322.000 LF	_____.	_____.
0014	204.0190 Removing Surface Drains	3.000 EACH	_____.	_____.
0016	205.0100 Excavation Common	59.000 CY	_____.	_____.
0018	206.1000 Excavation for Structures Bridges (structure) 01. B-05-465	LS	LUMP SUM	_____.
0020	208.0100 Borrow	17.000 CY	_____.	_____.
0022	210.1500 Backfill Structure Type A	430.000 TON	_____.	_____.
0024	213.0100 Finishing Roadway (project) 01. 4085-62-71	1.000 EACH	_____.	_____.
0026	305.0110 Base Aggregate Dense 3/4-Inch	70.000 TON	_____.	_____.
0028	305.0120 Base Aggregate Dense 1 1/4-Inch	209.000 TON	_____.	_____.
0030	305.0130 Base Aggregate Dense 3-Inch	404.000 TON	_____.	_____.
0032	415.0410 Concrete Pavement Approach Slab	70.000 SY	_____.	_____.



## Proposal Schedule of Items

Proposal ID: 20221011004 Project(s): 4085-62-71

Federal ID(s): WISC 2023005

SECTION: 0001

Contract Items

Alt Set ID:

Alt Mbr ID:

Proposal Line Number	Item ID Description	Approximate Quantity and Units	Unit Price	Bid Amount
0034	416.1010 Concrete Surface Drains	13.000 CY	_____	_____
0036	455.0605 Tack Coat	25.000 GAL	_____	_____
0038	460.2000 Incentive Density HMA Pavement	550.000 DOL	1.00000	550.00
0040	460.6223 HMA Pavement 3 MT 58-28 S	72.000 TON	_____	_____
0042	460.6224 HMA Pavement 4 MT 58-28 S	24.000 TON	_____	_____
0044	502.0100 Concrete Masonry Bridges	574.000 CY	_____	_____
0046	502.3200 Protective Surface Treatment	732.000 SY	_____	_____
0048	502.3210 Pigmented Surface Sealer	269.000 SY	_____	_____
0050	503.0137 Prestressed Girder Type I 36W-Inch	1,180.000 LF	_____	_____
0052	505.0400 Bar Steel Reinforcement HS Structures	12,080.000 LB	_____	_____
0054	505.0600 Bar Steel Reinforcement HS Coated Structures	96,200.000 LB	_____	_____
0056	506.2605 Bearing Pads Elastomeric Non-Laminated	30.000 EACH	_____	_____
0058	506.4000 Steel Diaphragms (structure) 01. B-05-465	16.000 EACH	_____	_____
0060	516.0500 Rubberized Membrane Waterproofing	20.000 SY	_____	_____
0062	550.1100 Piling Steel HP 10-Inch X 42 Lb	1,480.000 LF	_____	_____
0064	550.1120 Piling Steel HP 12-Inch X 53 Lb	2,240.000 LF	_____	_____



## Proposal Schedule of Items

Proposal ID: 20221011004 Project(s): 4085-62-71

Federal ID(s): WISC 2023005

SECTION: 0001

Contract Items

Alt Set ID:

Alt Mbr ID:

Proposal Line Number	Item ID Description	Approximate Quantity and Units	Unit Price	Bid Amount
0066	601.0588 Concrete Curb & Gutter 4-Inch Sloped 36-Inch Type TBT	101.000 LF	_____.	_____.
0068	604.0600 Slope Paving Select Crushed Material	670.000 SY	_____.	_____.
0070	606.0200 Riprap Medium	15.000 CY	_____.	_____.
0072	612.0406 Pipe Underdrain Wrapped 6-Inch	140.000 LF	_____.	_____.
0074	614.0150 Anchor Assemblies for Steel Plate Beam Guard	4.000 EACH	_____.	_____.
0076	614.2300 MGS Guardrail 3	1,251.000 LF	_____.	_____.
0078	614.2500 MGS Thrie Beam Transition	177.000 LF	_____.	_____.
0080	614.2610 MGS Guardrail Terminal EAT	1.000 EACH	_____.	_____.
0082	614.2620 MGS Guardrail Terminal Type 2	2.000 EACH	_____.	_____.
0084	619.1000 Mobilization	1.000 EACH	_____.	_____.
0086	624.0100 Water	11.000 MGAL	_____.	_____.
0088	625.0500 Salvaged Topsoil	2,367.000 SY	_____.	_____.
0090	628.1504 Silt Fence	1,066.000 LF	_____.	_____.
0092	628.1520 Silt Fence Maintenance	1,066.000 LF	_____.	_____.
0094	628.2002 Erosion Mat Class I Type A	510.000 SY	_____.	_____.
0096	628.2004 Erosion Mat Class I Type B	1,838.000 SY	_____.	_____.



Proposal Schedule of Items

Proposal ID: 20221011004 Project(s): 4085-62-71

Federal ID(s): WISC 2023005

SECTION: 0001

Contract Items

Alt Set ID:

Alt Mbr ID:

Proposal Line Number	Item ID Description	Approximate Quantity and Units	Unit Price	Bid Amount
0098	628.7570 Rock Bags	20.000 EACH	_____.	_____.
0100	629.0210 Fertilizer Type B	1.500 CWT	_____.	_____.
0102	630.0170 Seeding Mixture No. 70	11.000 LB	_____.	_____.
0104	630.0200 Seeding Temporary	80.000 LB	_____.	_____.
0106	630.0500 Seed Water	54.000 MGAL	_____.	_____.
0108	642.5001 Field Office Type B	1.000 EACH	_____.	_____.
0110	643.0300 Traffic Control Drums	3,840.000 DAY	_____.	_____.
0112	643.0420 Traffic Control Barricades Type III	2,520.000 DAY	_____.	_____.
0114	643.0705 Traffic Control Warning Lights Type A	3,240.000 DAY	_____.	_____.
0116	643.0715 Traffic Control Warning Lights Type C	3,840.000 DAY	_____.	_____.
0118	643.0900 Traffic Control Signs	8,880.000 DAY	_____.	_____.
0120	643.0910 Traffic Control Covering Signs Type I	1.000 EACH	_____.	_____.
0122	643.0920 Traffic Control Covering Signs Type II	2.000 EACH	_____.	_____.
0124	643.1050 Traffic Control Signs PCMS	14.000 DAY	_____.	_____.
0126	643.5000 Traffic Control	1.000 EACH	_____.	_____.
0128	645.0111 Geotextile Type DF Schedule A	51.000 SY	_____.	_____.
0130	645.0120 Geotextile Type HR	9.000 SY	_____.	_____.



Proposal Schedule of Items

Proposal ID: 20221011004 Project(s): 4085-62-71

Federal ID(s): WISC 2023005

SECTION: 0001

Contract Items

Alt Set ID:

Alt Mbr ID:

Proposal Line Number	Item ID Description	Approximate Quantity and Units	Unit Price	Bid Amount
0132	646.1020 Marking Line Epoxy 4-Inch	559.000 LF	_____.	_____.
0134	650.4500 Construction Staking Subgrade	917.000 LF	_____.	_____.
0136	650.5500 Construction Staking Curb Gutter and Curb & Gutter	101.000 LF	_____.	_____.
0138	650.6500 Construction Staking Structure Layout (structure) 01. B-05-465	LS	LUMP SUM	_____.
0140	650.9910 Construction Staking Supplemental Control (project) 4085-62-71	LS	LUMP SUM	_____.
0142	650.9920 Construction Staking Slope Stakes	917.000 LF	_____.	_____.
0144	690.0150 Sawing Asphalt	28.000 LF	_____.	_____.
0146	690.0250 Sawing Concrete	16.000 LF	_____.	_____.
0148	715.0502 Incentive Strength Concrete Structures	3,000.000 DOL	1.00000	3,000.00
0150	715.0720 Incentive Compressive Strength Concrete Pavement	500.000 DOL	1.00000	500.00
0152	ASP.1T0A On-the-Job Training Apprentice at \$5.00/HR	1,200.000 HRS	5.00000	6,000.00
0154	ASP.1T0G On-the-Job Training Graduate at \$5.00/HR	600.000 HRS	5.00000	3,000.00
0156	SPV.0060 Special 100. Temporary Slope Drain	2.000 EACH	_____.	_____.
0158	SPV.0090 Special 100. Removing Existing Steel Piling	735.000 LF	_____.	_____.
0160	416.0610 Drilled Tie Bars	20.000 EACH	_____.	_____.



Proposal Schedule of Items

Proposal ID: 20221011004 Project(s): 4085-62-71

Federal ID(s): WISC 2023005

SECTION: 0001

Contract Items

Alt Set ID:

Alt Mbr ID:

Proposal Line Number	Item ID Description	Approximate Quantity and Units	Unit Price	Bid Amount
0162	416.0620 Drilled Dowel Bars	16.000 EACH	_____.	_____.
0164	416.1720 Concrete Pavement Replacement	60.000 SY	_____.	_____.
0166	601.0409 Concrete Curb & Gutter 30-Inch Type A	60.000 LF	_____.	_____.
Section: 0001			<b>Total:</b>	_____.
			<b>Total Bid:</b>	_____.