

HIGHWAY WORK PROPOSAL

Wisconsin Department of Transportation
DT1502 01/2020 s.66.0901(7) Wis. Stats

Proposal Number: **016**

<u>COUNTY</u>	<u>STATE PROJECT</u>	<u>FEDERAL</u>	<u>PROJECT DESCRIPTION</u>	<u>HIGHWAY</u>
Milwaukee	1000-57-70	FR-CRS-0068-2	Milwaukee Airport 2nd Platform; Rr Crossing 393023r To 1200ft South	STH 119

ADDENDUM REQUIRED ATTACHED AT BACK

This proposal, submitted by the undersigned bidder to the Wisconsin Department of Transportation, is in accordance with the advertised request for proposals. The bidder is to furnish and deliver all materials, and to perform all work for the improvement of the designated project in the time specified, in accordance with the appended Proposal Requirements and Conditions.

Proposal Guaranty Required: \$360,000.00 Payable to: Wisconsin Department of Transportation	Attach Proposal Guaranty on back of this PAGE.
Bid Submittal Date: December 13, 2022 Time (Local Time): 11:00 am	Firm Name, Address, City, State, Zip Code <h3 style="margin: 0;">SAMPLE</h3> <h3 style="margin: 0;">NOT FOR BIDDING PURPOSES</h3>
Contract Completion Time June 30, 2024	This contract is exempt from federal oversight.
Assigned Disadvantaged Business Enterprise Goal 5%	

This certifies that the undersigned bidder, duly sworn, is an authorized representative of the firm named above; that the bidder has examined and carefully prepared the bid from the plans, Highway Work Proposal, and all addenda, and has checked the same in detail before submitting this proposal or bid; and that the bidder or agents, officer, or employees have not, either directly or indirectly, entered into any agreement, participated in any collusion, or otherwise taken any action in restraint of free competitive bidding in connection with this proposal bid.

Do not sign, notarize, or submit this Highway Work Proposal when submitting an electronic bid on the Internet.

Subscribed and sworn to before me this date _____

(Signature, Notary Public, State of Wisconsin)

(Bidder Signature)

(Print or Type Name, Notary Public, State Wisconsin)

(Print or Type Bidder Name)

(Date Commission Expires)

(Bidder Title)

Notary Seal

Type of Work: Grading, Base, Asphalt Pavement, Train Station Towers and Pedestrian Bridge Construction, Storm Sewer, Curb and Gutter, Sidewalk, Fencing, Sanitary Sewer, Pavement Markings, Tree Plantings	For Department Use Only
Notice of Award Dated	Date Guaranty Returned

**PLEASE ATTACH
PROPOSAL GUARANTY HERE**

PROPOSAL REQUIREMENTS AND CONDITIONS

The bidder, signing and submitting this proposal, agrees and declares as a condition thereof, to be bound by the following conditions and requirements.

If the bidder has a corporate relationship with the proposal design engineering company, the bidder declares that it did not obtain any facts, data, or other information related to this proposal from the design engineering company that was not available to all bidders.

The bidder declares that they have carefully examined the site of, and the proposal, plans, specifications and contract forms for the work contemplated, and it is assumed that the bidder has investigated and is satisfied as to the conditions to be encountered, as to the character, quality, and quantities of work to be performed and materials to be furnished, and as to the requirements of the specifications, special provisions and contract. It is mutually agreed that submission of a proposal shall be considered conclusive evidence that the bidder has made such examination.

The bidder submits herewith a proposal guaranty in proper form and amount payable to the party as designated in the advertisement inviting proposals, to be retained by and become the property of the owner of the work in the event the undersigned shall fail to execute the contract and contract bond and return the same to the office of the engineer within fourteen (14) days after having been notified in writing to do so; otherwise to be returned.

The bidder declares that they understand that the estimate of quantities in the attached schedule is approximate only and that the attached quantities may be greater or less in accordance with the specifications.

The bidder agrees to perform the said work, for and in consideration of the payment of the amount becoming due on account of work performed, according to the unit prices bid in the following schedule, and to accept such amounts in full payment of said work.

The bidder declares that all of the said work will be performed at their own proper cost and expense, that they will furnish all necessary materials, labor, tools, machinery, apparatus, and other means of construction in the manner provided in the applicable specifications and the approved plans for the work together with all standard and special designs that may be designed on such plans, and the special provisions in the contract of which this proposal will become a part, if and when accepted. The bidder further agrees that the applicable specifications and all plans and working drawings are made a part hereof, as fully and completely as if attached hereto.

The bidder, if awarded the contract, agrees to begin the work not later than ten (10) days after the date of written notification from the engineer to do so, unless otherwise stipulated in the special provisions.

The bidder declares that if they are awarded the contract, they will execute the contract agreement and begin and complete the work within the time named herein, and they will file a good and sufficient surety bond for the amount of the contract for performance and also for the full amount of the contract for payment.

The bidder, if awarded the contract, shall pay all claims as required by Section 779.14, Statutes of Wisconsin, and shall be subject to and discharge all liabilities for injuries pursuant to Chapter 102 of the Statutes of Wisconsin, and all acts amendatory thereto. They shall further be responsible for any damages to property or injury to persons occurring through their own negligence or that of their employees or agents, incident to the performance of work under this contract, pursuant to the Standard Specifications for Road and Bridge Construction applicable to this contract.

In connection with the performance of work under this contract, the contractor agrees to comply with all applicable state and federal statutes relating to non-discrimination in employment. No otherwise qualified person shall be excluded from employment or otherwise be subject to discrimination in employment in any manner on the basis of age, race, religion, color, gender, national origin or ancestry, disability, arrest or conviction record (in keeping with s.111.32), sexual orientation, marital status, membership in the military reserve, honesty testing, genetic testing, and outside use of lawful products. This provision shall include, but not be limited to the following: employment, upgrading, demotion or transfer; recruitment or recruitment advertising; layoff or termination; rates of pay or other forms of compensation, and selection for training, including apprenticeship. The contractor further agrees to ensure equal opportunity in employment to all applicants and employees and to take affirmative action to attain a representative workforce.

The contractor agrees to post notices and posters setting forth the provisions of the nondiscrimination clause, in a conspicuous and easily accessible place, available for employees and applicants for employment.

If a state public official (section 19.42, Stats.) or an organization in which a state public official holds at least a 10% interest is a party to this agreement, this contract is voidable by the state unless appropriate disclosure is made to the State of Wisconsin Ethics Board.

BID PREPARATION

Preparing the Proposal Schedule of Items

A. General

- (1) Obtain bidding proposals as specified in section 102 of the standard specifications prior to 11:45 AM of the last business day preceding the letting. Submit bidding proposals using one of the following methods:
 1. Electronic bid on the internet.
 2. Electronic bid on a printout with accompanying diskette or CD ROM.
 3. Paper bid under a waiver of the electronic submittal requirements.
- (2) Bids submitted on a printout with accompanying diskette or CD ROM or paper bids submitted under a waiver of the electronic submittal requirements govern over bids submitted on the internet.
- (3) The department will provide bidding information through the department's web site at:

<https://wisconsin.gov/Pages/doing-bus/contractors/hcci/bid-let.aspx>

The contractor is responsible for reviewing this web site for general notices as well as information regarding proposals in each letting. The department will also post special notices of all addenda to each proposal through this web site no later than 4:00 PM local time on the Thursday before the letting. Check the department's web site after 5:00 PM local time on the Thursday before the letting to ensure all addenda have been accounted for before preparing the bid. When bidding using methods 1 and 2 above, check the Bid Express™ on-line bidding exchange at <http://www.bidx.com/> after 5:00 PM local time on the Thursday before the letting to ensure that the latest schedule of items Expedite file (*.ebs or *.00x) is used to submit the final bid.

- (4) Interested parties can subscribe to the Bid Express™ on-line bidding exchange by following the instructions provided at the www.bidx.com web site or by contacting:

Info Tech Inc.
5700 SW 34th Street, Suite 1235
Gainesville, FL 32608-5371
email: <mailto:customer.support@bidx.com>

- (5) The department will address equipment and process failures, if the bidder can demonstrate that those failures were beyond their control.
- (6) Contractors are responsible for checking on the issuance of addenda and for obtaining the addenda. Notice of issuance of addenda is posted on the department's web site at:

<https://wisconsin.gov/Pages/doing-bus/contractors/hcci/bid-let.aspx>

or by calling the department at (608) 266-1631. Addenda can ONLY be obtained from the department's web site listed above or by picking up the addenda at the Bureau of Highway Construction, 4th floor, 4822 Madison Yards Way, Madison, WI, during regular business hours.

- (7) Addenda posted after 5:00 PM on the Thursday before the letting will be emailed to the eligible bidders for that proposal. All eligible bidders shall acknowledge receipt of the addenda whether they are bidding on the proposal or not. Not acknowledging receipt may jeopardize the awarding of the project.

B. Submitting Electronic Bids

B.1 On the Internet

- (1) Do the following before submitting the bid:
 4. Have a properly executed annual bid bond on file with the department.
 5. Have a digital ID on file with and enabled by Info Tech Inc. Using this digital ID will constitute the bidder's signature for proper execution of the bidding proposal.
- (2) In lieu of preparing, delivering, and submitting the proposal as specified in 102.6 and 102.9 of the standard specifications, submit the proposal on the internet as follows:
 1. Download the latest schedule of items reflecting all addenda from the Bid Express™ web site.
 2. Use Expedite™ software to enter a unit price for every item in the schedule of items.
 3. Submit the bid according to the requirements of Expedite™ software and the Bid Express™ web site. Do not submit a bid on a printout with accompanying diskette or CD ROM or a paper bid. If the bidder does submit a bid on a printout with accompanying diskette or a paper bid in addition to the internet submittal, the department will disregard the internet bid.
 4. Submit the bid before the hour and date the Notice to Contractors designates.
 5. Do not sign, notarize, and return the bidding proposal described in 102.2 of the standard specifications.
- (3) The department will not consider the bid accepted until the hour and date the Notice to Contractors designates.

B.2 On a Printout with Accompanying Diskette or CD ROM

- (1) Download the latest schedule of items from the Wisconsin pages of the Bid Express web site reflecting the latest addenda posted on the department's web site at:
<https://wisconsin.gov/Pages/doing-bus/contractors/hcci/bid-let.aspx>
 Use Expedite™ software to prepare and print the schedule of items. Provide a valid amount for all price fields. Follow instructions and review the help screens provided on the Bid Express™ web site to assure that the schedule of items is prepared properly.

- (2) Staple an 8 1/2 by 11 inch printout of the Expedite™ generated schedule of items to the other proposal documents submitted to the department as a part of the bidder's sealed bid. As a separate submittal, not in the sealed bid envelope but due at the same time and place as the sealed bid, also provide the Expedite™ generated schedule of items on a 3 1/2 inch computer diskette or CD ROM. Label each diskette or CD ROM with the bidder's name, the 4 character department-assigned bidder identification code from the top of the bidding proposal, and a list of the proposal numbers included on that diskette or CD ROM as indicated in the following example:

Bidder Name

BN00

Proposals: 1, 12, 14, & 22

- (3) If bidding on more than one proposal in the letting, the bidder may include all proposals for that letting on one diskette or CD ROM. Include only submitted proposals with no incomplete or other files on the diskette or CD ROM.
- (4) The bidder-submitted printout of the Expedite™ generated schedule of items is the governing contract document and must conform to the requirements of section 102 of the standard specifications. If a printout needs to be altered, cross out the printed information with ink or typewriter and enter the new information and initial it in ink. If there is a discrepancy between the printout and the diskette or CD ROM, the department will analyze the bid using the printout information.

- (5) In addition to the reasons specified in section 102 of the standard specifications, proposals are irregular and the department may reject them for one or more of the following:
1. The check code printed on the bottom of the printout of the Expedite™ generated schedule of items is not the same on each page.
 2. The check code printed on the printout of the Expedite™ generated schedule of items is not the same as the check code for that proposal provided on the diskette or CD ROM.
 3. The diskette or CD ROM is not submitted at the time and place the department designates.

B Waiver of Electronic Submittal

- (1) The bidder may request a waiver of the electronic submittal requirements. Submit a written request for a waiver in lieu of bids submitted on the internet or on a printout with accompanying diskette or CD ROM. Use the waiver that was included with the paper bid document sent to the bidder or type up a waiver on the bidder's letterhead. The department will waive the electronic submittal requirements for a bidding entity (individual, partnership, joint venture, corporation, or limited liability company) for up to 4 individual proposals in a calendar year. The department may allow additional waivers for equipment malfunctions.
- (2) Submit a schedule of items on paper conforming to section 102 of the standard specifications. The department charges the bidder a \$75 administrative fee per proposal, payable at the time and place the department designates for receiving bids, to cover the costs of data entry. The department will accept a check or money order payable to: "Wisconsin, Dept. of Transportation."
- (3) In addition to the reasons specified in section 102 of the standard specifications, proposals are irregular and the department may reject them for one or more of the following:
 1. The bidder fails to provide the written request for waiver of the electronic submittal requirements.
 2. The bidder fails to pay the \$75 administrative fee before the time the department designates for the opening of bids unless the bidder requests on the waiver that they be billed for the \$75.
 3. The bidder exceeds 4 waivers of electronic submittal requirements within a calendar year.
- (4) In addition to the reasons specified in section 102 of the standard specifications, the department may refuse to issue bidding proposals for future contracts to a bidding entity that owes the department administrative fees for a waiver of electronic submittal requirements.

PROPOSAL BID BOND

DT1303 1/2006

Wisconsin Department of Transportation

Proposal Number	Project Number	Letting Date
Name of Principal		
Name of Surety	State in Which Surety is Organized	

We, the above-named Principal and the above-named Surety, are held and firmly bound unto the State of Wisconsin in the sum equal to the Proposal Guaranty for the total bid submitted for the payment to be made; we jointly and severally bind ourselves, our heirs, executors, administrators, successors and assigns. The condition of this obligation is that the Principal has submitted a bid proposal to the State of Wisconsin acting through the Department of Transportation for the improvement designated by the Proposal Number and Letting Date indicated above.

If the Principal is awarded the contract and, within the time and manner required by law after the prescribed forms are presented for signature, enters into a written contract in accordance with the bid, and files the bond with the Department of Transportation to guarantee faithful performance and payment for labor and materials, as required by law, or if the Department of Transportation shall reject all bids for the work described, then this obligation shall be null and void; otherwise, it shall be and remain in full force and effect. In the event of failure of the Principal to enter into the contract or give the specified bond, the Principal shall pay to the Department of Transportation **within 10 business days of demand** a total equal to the Proposal Guaranty as liquidated damages; the liability of the Surety continues for the full amount of the obligation as stated until the obligation is paid in full.

The Surety, for value received, agrees that the obligations of it and its bond shall not be impaired or affected by any extension of time within which the Department of Transportation may accept the bid; and the Surety does waive notice of any such extension.

IN WITNESS, the Principal and Surety have agreed and have signed by their proper officers and have caused their corporate seals to be affixed this date: **(DATE MUST BE ENTERED)**

PRINCIPAL

(Company Name) **(Affix Corporate Seal)**

(Signature and Title)

(Company Name)

(Signature and Title)

(Company Name)

(Signature and Title)

(Company Name)

(Signature and Title)

(Name of Surety) **(Affix Seal)**

(Signature of Attorney-in-Fact)

NOTARY FOR PRINCIPAL

(Date)

State of Wisconsin)
) ss.
_____ County)

On the above date, this instrument was acknowledged before me by the named person(s).

(Signature, Notary Public, State of Wisconsin)

(Print or Type Name, Notary Public, State of Wisconsin)

(Date Commission Expires)

Notary Seal

NOTARY FOR SURETY

(Date)

State of Wisconsin)
) ss.
_____ County)

On the above date, this instrument was acknowledged before me by the named person(s).

(Signature, Notary Public, State of Wisconsin)

(Print or Type Name, Notary Public, State of Wisconsin)

(Date Commission Expires)

Notary Seal

IMPORTANT: A certified copy of Power of Attorney of the signatory agent must be attached to the bid bond.

CERTIFICATE OF ANNUAL BID BOND

DT1305 8/2003

Wisconsin Department of Transportation

Time Period Valid (From/To)
Name of Surety
Name of Contractor
Certificate Holder Wisconsin Department of Transportation

This is to certify that an annual bid bond issued by the above-named Surety is currently on file with the Wisconsin Department of Transportation.

This certificate is issued as a matter of information and conveys no rights upon the certificate holder and does not amend, extend or alter the coverage of the annual bid bond.

Cancellation: Should the above policy be cancelled before the expiration date, the issuing surety will give thirty (30) days written notice to the certificate holder indicated above.

(Signature of Authorized Contractor Representative)

(Date)

CERTIFICATION REGARDING DEBARMENT, SUSPENSION, AND OTHER RESPONSIBILITY MATTERS - PRIMARY COVERED TRANSACTIONS

Instructions for Certification

1. By signing and submitting this proposal, the prospective contractor is providing the certification set out below.
2. The inability of a person to provide the certification required below will not necessarily result in denial of participation in this covered transaction. The prospective contractor shall submit an explanation of why it cannot provide the certification set out below. The certification or explanation will be considered in connection with the department or agency's determination whether to enter into this transaction. However, failure of the prospective contractor to furnish a certification or an explanation shall disqualify such person from participation in this transaction.
3. The certification in this clause is a material representation of fact upon which reliance was placed when the department determined to enter into this transaction. If it is later determined that the contractor knowingly rendered an erroneous certification in addition to other remedies available to the Federal Government the department may terminate this transaction for cause or default.
4. The prospective contractor shall provide immediate written notice to the department to whom this proposal is submitted if at any time the prospective contractor learns that its certification was erroneous when submitted or has become erroneous by reason of changed circumstances.
5. The terms "covered transaction," "debarred," "suspended," "ineligible," "lower tier covered transaction," "participant," "person," "primary covered transaction," "principal," "proposal," and "voluntarily excluded," as used in this clause, have the meanings set out in the Definitions and Coverage sections of the rules implementing Executive Order 12549. You may contact the department to which this proposal is being submitted for assistance in obtaining a copy of those regulations.
6. The prospective contractor agrees by submitting this proposal that, should this contract be entered into, it shall not knowingly enter into any lower tier covered transaction with a person who is debarred, suspended, declared ineligible, or voluntarily excluded from participation in this covered transaction, unless authorized by the department entering into this transaction.
7. The prospective contractor further agrees by submitting this proposal that it will include the clause titled "Certification Regarding Debarment, Suspension, Ineligibility and Voluntary Exclusion-Lower Tier Covered Transaction," which is included as an addendum to PR- 1273 - "Required Contract Provisions Federal Aid Construction Contracts," without modification, in all lower tier covered transactions and in all solicitations for lower tier covered transactions.
8. The contractor may rely upon a certification of a prospective subcontractor/materials supplier that it is not debarred, suspended, ineligible, or voluntarily excluded from the covered transaction, unless it knows that the certification is erroneous. A contractor may decide the method and frequency by which it determines the eligibility of its principals. Each contractor may, but is not required to, check the Disapproval List (telephone # 608/266/1631).

9. Nothing contained in the foregoing shall be construed to require establishment of a system of records in order to render in good faith the certification required by this clause. The knowledge and information of a contractor is not required to exceed that which is normally possessed by a prudent person in the ordinary course of business dealings.
10. Except for transactions authorized under paragraph 6 of these instructions, if a contractor in a covered transaction knowingly enters into a lower tier covered transaction with a person who is suspended, debarred, ineligible or voluntarily excluded from participation in this transaction, in addition to other remedies available to the Federal Government, the department may terminate this transaction for cause or default.

Certification Regarding Debarment, Suspension, and Other Responsibility Matters - Primary Covered Transactions

1. The prospective contractor certifies to the best of its knowledge and belief, that it and its principals:
 - (a) Are not presently debarred, suspended, proposed for debarment, declared ineligible, or voluntarily excluded from covered transactions by any Federal department or agency;
 - (b) Have not within a three-year period preceding this proposal been convicted of or had a civil judgment rendered against them for commission of fraud or a criminal offense in connection with obtaining, attempting to obtain, or performing a public (Federal, State or local) transaction or contract under a public transaction; violation of Federal or State antitrust statutes or commission of embezzlement, theft, forgery, bribery, falsification or destruction of records, making false statements or receiving stolen property;
 - (c) Are not presently indicted for or otherwise criminally or civilly charged by a governmental entity (Federal, State or local) with commission of any of the offense enumerated in paragraph (1)(b) of this certification; and
 - (d) Have not within a three-year period preceding this proposal had one or more public transactions (Federal, State or local) terminated for cause or default.
2. Where the prospective contractor is unable to certify to any of the statements in this certification, such prospective contractor shall attach an explanation to this proposal.

Special Provisions

Table of Contents

Article	Description	Page #
1.	General	3
2.	Scope of Work	3
3.	Mandatory Pre-Bid Meeting	3
4.	Prosecution and Progress	4
5.	Traffic	6
6.	Holiday and Special Event Work Restrictions	9
7.	Utilities	10
8.	Railroad Insurance and Coordination - Soo Line Railroad Company (CP)	12
9.	Public Convenience and Safety	16
10.	Environmental Protection, Aquatic Exotic Species Control	16
11.	Sanitary Sewer and Water Main Construction	17
12.	Notice to Contractor -- Federal Aviation Administration Coordination	17
13.	Removing Landscaping Boulders, Item 204.9060.S	17
14.	Removing Bollards, Item 204.9060.S	18
15.	Select Borrow, Item 208.1100	18
16.	QMP Drilled Shafts	18
17.	Cover Plates Temporary, Item 611.8120.S	24
18.	Tracer Wire 12 AWG	24
19.	Underdrain Cleanout	25
20.	Fence Safety, Item 616.0700.S	25
21.	Seeding	26
22.	Landscape Planting Surveillance and Care Cycles	26
23.	Lamp, Ballast, LED, Switch Disposal by Contractor, Item 659.5000.S	26
24.	Diesel-Engine-Driven Generator Sets, Item SPV.0060.01	28
25.	Canopy Column Anchor Rod Assemblies, Item SPV.0060.02; Tower Column Anchor Rod Assemblies, Item SPV.0060.03	42
26.	Switchboards, Item SPV.0060.04	43
27.	Transfer Switches, Item SPV.0060.05	53
28.	Traction Elevators, Item SPV.0060.06	61
29.	Doors and Door Hardware, Item SPV.0060.07	85
30.	Utility Line Opening (ULO), Item SPV.0060.08	111
31.	Marking Line Paint Text 4-Inch Black, Item SPV.0060.09	111
32.	Pipe Bollard, Item SPV.0060.10	112
33.	Sanitary Manhole 4-Foot, Item SPV.0060.11	113
34.	Grass, Blue Oat, Item SPV.0060.12; Grass, Hameln Dwarf Fountain, Item SPV.0060.13; Grass, Karl Foerster Reed, Item SPV.0060.14	114

35.	Remove and Salvage Lighting Equipment, Item SPV.0060.15.	114
36.	Fall Restraint System, Item SPV.0060.16.	115
37.	HVAC Work, Item SPV. 0060.17.	123
38.	Lighting, Item SPV. 0060.18.	145
39.	General Electrical Work, Item SPV.0060.19.	149
40.	Fire Alarm System, Item SPV.0060.20.	178
41.	Lightning Protection for Structures, Item SPV.0060.21.	181
42.	Plumbing Work, Item SPV.0060.22.	182
43.	Stairs, Item SPV.0060.23.	234
44.	Rough Carpentry, Item SPV.0060.24.	243
45.	Metal Fabrications, Item SPV.0060.25.	260
46.	Gypsum Board Partitions and Assemblies, Item SPV.0060.26.	274
47.	Ceilings, Item SPV.0060.27.	304
48.	Interior and Exterior Signage, Item SPV.0060.28.	311
49.	Other Architectural Work, Item SPV.0060.29.	313
50.	Fire Suppression, Item SPV.0060.30.	342
51.	PIDS, Communications, and Security Work, Item SPV.0060.31.	350
52.	Wheelchair Lift Enclosure, New and Relocation, Item SPV.0060.32.	375
53.	Structural Steel, Item SPV.0085.01.	376
54.	Railing Pipe, Item SPV.0090.01.	380
55.	Drilled Shaft Foundations 24-inch, Item SPV.0090.02.	389
56.	Helical Pile, Item SPV.0090.03.	400
57.	Marking Line Paint 4.5-Inch Yellow, Item SPV.0090.04.	403
58.	Marking Line Contrast Paint 2-Inch Black, Item SPV.0090.05.	404
59.	Removable Intertrack Fence, Item SPV.0090.06.	404
60.	Sanitary Sewer Pipe PVC 6-Inch, Item SPV.0090.07.	405
61.	Sanitary Sewer Pipe PVC 8-Inch, Item SPV.0090.08.	406
62.	Concrete Barrier Temporary Precast Left In Place, Item SPV.0090.09.	406
63.	Construction Staking Fence, Item SPV.0090.	407
64.	Masonry and Cast Stone Work, Item SPV.0165.01.	407
65.	Steel Decking, Item SPV.0165.02.	436
66.	Aluminum and Glass Curtain Walls, Item SPV.0165.03.	441
67.	Roofing and Accessories, Item SPV.0165.04.	480
68.	Exterior Metal Panels, Item SPV.0165.05.	546
69.	Louvers, Item SPV.0165.06.	555
70.	Finishes, Item SPV.0165.07.	561
71.	Temporary Shoring Railroad, Item SPV.0165.08.	582

STSP'S Revised June 28, 2022

SPECIAL PROVISIONS

1. General.

Perform the work under this construction contract for Project 1000-57-70, Milwaukee Airport Rail Station 2nd Platform RR Crossing 393023R to 1200FT South EX-RR Crossing Improvement, Milwaukee County, Wisconsin as the plans show and execute the work as specified in the State of Wisconsin, Department of Transportation, Standard Specifications for Highway and Structure Construction, 2023 Edition, as published by the department, and these special provisions.

If all or a portion of the plans and special provisions are developed in the SI metric system and the schedule of prices is developed in the US standard measure system, the department will pay for the work as bid in the US standard system.

100-005 (20220628)

2. Scope of Work.

The work under this contract shall consist of building construction, plumbing, HVAC, electrical, pedestrian bridge construction, concrete platform, asphalt paving, concrete sidewalks, lighting, emergency systems, storm sewer, and all incidental items necessary to complete the work as shown on the plans and included in the proposal and contract.

104-005 (20090901)

3. Mandatory Pre-Bid Meeting.

Add the following to standard spec 102.3.1:

Prospective bidders are required to attend a mandatory pre-bid meeting Tuesday, November 15, 2022, at 1:00 PM at WisDOT Southeast Region Office, 141 NW Barstow St, Waukesha, WI 53188 or virtually via the meeting link published on the HCCI website, and as provided below:

Microsoft Teams meeting

Join on your computer, mobile app or room device

[Click here to join the meeting](#)

Meeting ID: 253 482 035 679

Passcode: ozZbv5

[Download Teams](#) | [Join on the web](#)

Or call in (audio only)

[+1 608-571-2209,,91807317#](#) United States, Madison

Phone Conference ID: 918 073 17#

[Find a local number](#) | [Reset PIN](#)

[Learn More](#) | [Meeting options](#)

Contractors will be able to obtain a bidding proposal form and submit a bid on this proposal only if they have been documented as attending the mandatory pre-bid meeting.

The meeting agenda will include the following:

- Project Overview
- Railroad Coordination

- Airport Coordination
- Safety
- Contractor Compliance
- DBE Business Outreach Provision

No meeting minutes will be prepared, but a published response will be sent out addressing all questions raised at the meeting.

stp-102-010

4. Prosecution and Progress.

Begin work within 10 calendar days after the engineer issues a written notice to do so.

Provide the start date to the engineer in writing within a month after executing the contract but at least 14 calendar days before the preconstruction conference. Upon approval, the engineer will issue the notice to proceed within 10 calendar days before the approved start date.

To revise the start date, submit a written request to the engineer at least two weeks before the intended start date. The engineer will approve or deny that request based on the conditions cited in the request and its effect on the department's scheduled resources.

Northern Long-eared Bat (*Myotis septentrionalis*)

Northern Long-eared Bats (NLEB) have the potential to inhabit the project limits because they roost in trees, bridges, and culverts. Tree clearing areas specified in plans are not considered suitable summer habitat for NLEB and no tree clearing restrictions apply to those locations. Roosts may not have been observed on this project, but conditions to support the species exist. The species and all active roosts are protected by the Federal Endangered Species Act. If an individual bat or active roost is encountered during construction operations, stop work and notify the engineer and the WisDOT Regional Environmental Coordinator (REC).

Tree clearing is limited to that which is specified in the plans. If additional trees with a 3-inch or greater diameter at breast height (dgbh) need to be removed, no tree clearing shall occur without prior approval from the engineer, following coordination with the WisDOT REC. Additional tree removal beyond the area originally specified will require consultation with the United States Fish and Wildlife Service (USFWS) and may require a bat presence/absence survey. Notify the engineer if additional clearing cannot be avoided to begin coordination with the WisDOT REC. The WisDOT REC will initiate consultation with the USFWS and determine if a survey is necessary.

Submit a schedule and description of Clearing operations with the ECIP 14 days prior to any Clearing operations. The department will determine, based on schedule and scope of work, what additional erosion control measures shall be implemented prior to the start of Clearing operations, and list those additional measures in the ECIP.

Invasive Species

Emerald Ash Borer, Oak Wilt, invasive species are known to exist within the project limits and in areas that ground disturbance or excavation work is shown in the plans. For all equipment that comes into contact with invasive species infested areas, follow the guidelines established under the Environmental Protection, Aquatic Exotic Species Control section of this special provision for inspection and cleaning of equipment prior to leaving the project site. Additional information can be found at the following website: <http://dnr.wi.gov/topic/Invasives/species.asp?filterBy=Terrestrial&filterVal=Y&catVal=Plants>.

Contractor Coordination

Attend weekly scheduling meetings to discuss the near-term schedule activities, address any long-term schedule issues, and discuss any relevant technical issues. Develop a rolling three-week schedule identifying the previous week worked and a two week "look ahead". Provide sufficient detail to include actual and planned activities and all the subcontractors for offsite and construction activities, addressing all activities including ramp and lane closure schedules to be performed and identifying issues requiring engineering action or input. Subcontractors shall be in attendance at the weekly progress meetings if identified on the two week "look ahead".

Schedule of Operations

Complete work as detailed in the staging descriptions below. Modifications pertaining to what work is completed in each stage require prior written approval by the engineer.

Prior to any platform construction activities, track 1 and track 2 will have tie replacement performed by Canadian Pacific Railway.

Stage 1

- Construct contractor access from STH 119, and from 6th street through the existing parking area.
- Clear and grub site, complete fence removals, prepare site for construction.
- Start storm sewer and drainage.
- Close exterior public driveway and set traffic control to route traffic into parking lot prior to Stage 2.

Stage 2

- Complete tower foundations.
- Complete tower slabs.
- Complete storm sewer and drainage work.

Stage 3

- Complete tower steel erection.
- Complete bridge steel erection.

Stage 4

- Complete tower concrete floor and stair work.
- Complete platform foundations.
- Complete canopy foundations.
- Complete platform concrete.

Stage 5

- Work to be performed by Canadian Pacific Railway – Remove existing emergency track crossing and construct new emergency track crossing.
- Complete tower glass, brick, and veneer work on exteriors.
- Complete interior finishes.
- Complete platform canopy.
- Complete final grading around buildings.

Stage 6

- Complete personnel parking area.
- Complete sidewalk connections to buildings.
- Remove temporary contractor access to 6th street and restore areas.
- Open exterior public driveway to traffic.
- Restore STH 119 shoulder. Topsoil and seed over access road.
- Construct permanent fencing.
- Complete final landscaping.

5. Traffic.

The work under this item shall conform to the requirements of standard spec 643, the Manual on Uniform Traffic Control Devices (MUTCD) and as hereinafter provided.

Submit to the engineer for approval, a detailed traffic control plan if different than the traffic control plan provided in the Plans. Submit this plan to the engineer 14 working days prior to anticipated use. Do not perform construction operations until all traffic control devices for such work are in proper location.

General Work Zone Site Access

Contact the General Mitchell International Airport security office (Vincent Campagna at (414) 747-5705) a minimum of 30 days in advance of the construction start date to coordinate security clearances and access requirements.

Do not disturb portions of Project site beyond areas in which the Work is indicated.

Designated laydown areas are shown on the plans and no laydown areas shall be allowed unless approved by the engineer. Schedule deliveries to minimize use of driveways and entrances by construction operations. Schedule deliveries to minimize space and time requirements for storage of materials and equipment on-site.

During construction, maintain ADA compliant access to the station and all facilities. Maintain access to the two existing pedestrian crossings of the public driveway between the station and public parking lot at all times.

Work Zone Access East of Track 1 from 6th Street

The outer driveway around the public parking lot will be closed to the public during construction. All public traffic will be directed to enter the parking lot.

Use the outer driveway around the public parking lot for daily contractor access and deliveries. A temporary access driveway is permitted off of 6th Street south of the main entrance for construction access. Use the temporary access driveway off of 6th Street as the primary work zone access point unless the size of the equipment or delivery warrants the use of the main entrance. Do not park any vehicles or store materials along the outer driveway between the two pedestrian crossings on the outer driveway.

The authorized personnel parking lot south of the existing station will be closed during construction. This area will be within the work zone and allowed to be used by the contractor.

See plans for additional details of traffic control devices and required fencing.

Work Zone Access West of Track 2 from STH 119

Utilize WisDOT right-of-way, just south of STH 119, for contractor access to the west side tower location and designated material storage area. Construct access road as shown in the plans. Topsoil and seed the access road from STH 119 to the right-of-way fence at the end of construction. West access road to remain beyond the right-of-way fence at the end of the project as shown in the plans.

The perimeter of the Milwaukee County parcel to access is fenced with a chain link fence. A portion of the fence will be allowed to be temporarily removed as shown in the plans. A temporary fence will be required during construction.

Station Building

The existing Amtrak Hiawatha Service daily schedules operate from 6:00 AM to 10:00 PM Monday through Saturday and 7:45 AM to 10:00 PM on Sunday.

Access and walkways from the existing station to the east platform and public parking lot shall remain open at all times except for the walkway to the authorized parking lot which will be closed during construction.

East Platform

Maintain access to the existing portable wheelchair lift. Prior to closing the southern portion of the east platform, relocate the existing portable wheelchair lift as shown on the plans. Ensure that it is located on the operational portion of the platform and remains accessible at all times.

During construction of the east tower and pedestrian bridge, close the southern portion of the east platform immediately south of the junction of the walkway between the platform and the existing station. The platform shall be closed to the southern platform limit.

The walkways from the station and parking area to the operational portion(s) of the platform shall remain open at all times unless the engineer approves a short-term closure. Any requested short-term closures of the walkways shall be at times that do not impact Amtrak operations.

Crane/Hoisting Work Plan

Prepare a plan for bridge erection and other crane/hoisting operations over, or within Railroad right-of-way and Limits of Work. Work Plan shall include the following:

1. Plan view showing location(s) of cranes, operating radii, with delivery and/or disposal locations shown. Provide all necessary dimensions for locating the elements of the plan.
2. Plans and computations showing the weight of the pick, sealed by a Professional Engineer registered in the State where Work is performed.
3. Crane rating sheets, demonstrating that cranes are adequate for 150% of the calculated pick weight (the cranes shall be capable of picking 150% of the load, while maintaining normal, recommended factors of safety). The adequacy of the crane for the proposed pick shall be determined by using the manufacturer's published crane rating chart and not the maximum crane capacity. Crane and boom nomenclature is to be indicated.
4. Calculations demonstrating that slings, shackles, lifting beams, etc. are adequate for 150% of the calculated pick weight.
5. Location plan showing both horizontal and vertical obstructions, indicating that the proposed swing is possible. "Walking" of load using two cranes will not be permitted. Rather, multiple picks and repositioning of the crane may be permitted to get the load to the needed location for the final pick, if necessary.
6. Data sheet listing types and sizes of slings and other connecting equipment. Include copies of catalog cuts for specialized equipment. Detail attachment methods on the plans.

7. A complete procedure, indicating the order of lifts and any repositioning or re-hitching of the crane or cranes.
8. Temporary support of any components or intermediate stages, as may be required.
9. A time schedule of the various stages, as well as a schedule for the entire lifting process.
10. Certification of crane operator(s).
11. Seal of a Professional Engineer registered in the state where hoisting will be performed.

Traffic Staging

Stage traffic and pedestrian activities for proper execution of the Work and coordination with Amtrak and Canadian Pacific Railway operations. Provide any requested changes to staging plans for approval by the engineer. Indicate the Work included in each phase.

Before commencing Work of each phase, submit an updated copy of the Construction Schedule showing the sequence, commencement, and completion dates for all phases of the Work.

Staged Construction

Construction will occur while the CP Railway and Amtrak operations are maintained. Contractor activities on the project will be constrained per the requirements of CP Railway. Coordinate with the CP Railway 30 days prior to switching stages or conducting work within 50 feet of the active tracks.

Coordinate with General Mitchell International Airport 15 days prior to modifications to traffic routing or changes to the outer access road or parking lot.

Refer to the traffic control plans for additional detail.

Stage 1

- Maintain access for railroad maintenance vehicles along gravel road south of the existing building.
- Utilize standard detail drawings for STH 119 lane closures and truck ingress-egress, as needed, for the West Access Road construction and deliveries.

Stages 2 through 6

- Maintain public access into the parking lot for all traffic
- Provide temporary access through the parking area for daily users and drop-off, pick-up passenger traffic.
- Maintain a single lane, 14-feet wide, for emergency vehicles along the outer access road at all times.
- Utilize standard detail drawings for STH 119 lane closures and truck ingress-egress, as needed, for the West Access Road deliveries.

Stage 6

- At the completion of the east side work, open the outer access driveway to the public.

Allowable Lane Closures

All lane closures are subject to the approval of the Region traffic engineer. Times listed for lane closure restrictions include setup and breakdown of any equipment and traffic control devices. Lane closures are not allowed to take place during the holiday periods detailed in the Holiday Work Restrictions article.

Request approval from the engineer for all lane closures in advance as specified under Wisconsin Lane Closure System Advance Notification. A request does not constitute approval.

Notify the engineer if there are any changes in the schedule, early completions, or cancellations for scheduled work. Remove lane closures when work is not in progress.

During working hours, limit construction vehicles within the work zone to those vehicles necessary to complete the work.

Wisconsin Lane Closure System Advance Notification

Provide the following advance notification to the engineer for incorporation into the Wisconsin Lane Closure System (LCS).

TABLE 108-1 CLOSURE TYPE AND REQUIRED MINIMUM ADVANCE NOTIFICATION

Closure type with height, weight, or width restrictions (available width, all lanes in one direction < 16 feet)	MINIMUM NOTIFICATION
Lane and shoulder closures	7 calendar days
Full roadway closures	7 calendar days
Ramp closures	7 calendar days
Detours	7 calendar days
Closure type without height, weight, or width restrictions (available width, all lanes in one direction > 16 feet)	MINIMUM NOTIFICATION
Lane and shoulder closures	3 business days
Ramp closures	3 business days
Modifying all closure types	3 business days

Discuss LCS completion dates and provide changes in the schedule to the engineer at weekly project meetings in order to manage closures nearing their completion date.

6. Holiday and Special Event Work Restrictions.

Do not perform work on, nor haul materials of any kind along or across any portion of the highway carrying STH 119 traffic, and entirely clear the traveled way and shoulders of such portions of the highway of equipment, barricades, signs, lights, and any other material that might impede the free flow of traffic during the following holiday and special event periods:

- From noon Friday, December 23, 2022, to 6:00 AM Tuesday, December 27, 2022 for Christmas Eve;
- From noon Friday, December 30, 2022, to 6:00 AM Tuesday, January 3, 2023 for New Year's Eve;
- From noon Friday, May 26, 2023, to 6:00 AM Tuesday, May 30, 2023 for Memorial Day;
- From noon Friday, June 30, 2023, to 6:00 AM Wednesday, July 5, 2023 for Independence Day;
- From noon Friday, September 1, 2023, to 6:00 AM Tuesday, September 5, 2023 for Labor Day;
- From noon Wednesday, November 22, 2023 to 6:00 AM Monday, November 27, 2023 for Thanksgiving;
- From noon Friday, December 22, 2023, to 6:00 AM Tuesday, December 26, 2023 for Christmas Eve;
- From noon Friday, December 29, 2023, to 6:00 AM Tuesday, January 2, 2024 for New Year's Eve;
- From noon Friday, May 24, 2024, to 6:00 AM Tuesday, May 28, 2024 for Memorial Day.

stp-107-005 (20210113)

7. Utilities.

This contract does not come under the provision of Administrative Rule Trans 220.

stp-107-066 (20080501)

Underground and overhead utility facilities are located within the project limits. Utility adjustments are required for this project as noted below. Coordinate construction activities with a call to Diggers Hotline or a direct call to the utilities that have facilities in the area, as required per statutes.

Some of the utility work described below is dependent on prior work being performed by the contractor at a specific site. In such situations, provide the engineer and the affected utility a good faith notice of when the utility is to start work at the site. Provide this notice 14 to 16 calendar days in advance of when the prior work will be completed, and the site will be available to the utility owner. Follow-up with a confirmation notice to the engineer and the utility owner not less than three working days before the site will be ready for the utility owner to begin its work.

Contact each utility company listed in the plans, prior to preparing bids, to obtain current information on the status of existing and any new utility relocation work. The location of utility installations as described in this article are approximate.

American Transmission Company, LLC (ATC) – Electric has existing electric facilities within the project limits.

The existing overhead and tower electric facilities are parallel and west of Track 2, Station 98+00 – Station 108+00, 98'-210' LT. The existing facilities will remain in place without adjustment.

For access and work within the ATC easement:

- No trenching, boring, clearing and grubbing 25-feet around the face of any ATC transmission structures.
- Maintain a safe working clearance to the 138 kV conductors at all times based on the latest OSHA guidelines.
- ATC requires access to the easement at all times. No stockpiling of construction equipment or spoil piles at any time within the easement without prior ATC approval.
- No structures to be installed within the easement.
- No cutting and removal of the ATC fence without prior ATC notification and approval.
- The project requires will be removing a portion of the fence during construction for access. A temporary fence shall be maintained during construction.
- Notify ATC at least 3 days before construction: Chris Dailey, (414) 651-3950.

AT&T Wisconsin – Communications has existing communication facilities within the project limits.

The existing communication facilities are located north/south along the Access Road and turning northeast to the existing station building, Station 26+65 – Station 30+50, 10'-30' LT. The existing facilities will remain in place without adjustment.

General Mitchell International Airport (GMIA) has existing electric, communication, sanitary, and water facilities within the project limits.

GMIA – Electric Existing electric facilities are located north/south along the Access Road and turning northeast to the existing station building, Station 26+65 – Station 30+50, 13'-50' LT; diagonal across the Access Road to the existing building, Station 30+26- Station 30+57, 127' LT – 37' RT; and parallel and east of Track 1, Station 104+00 – Station 105+40, 9'-17' RT. The existing electric facilities between the existing station and east platform that are impacted by construction will be adjusted by the contractor in

accordance with the plans and specifications. Maintain the existing service to the east platform and lighting during construction.

GMIA – Communications: Existing communication facilities are located across the Access Road to the existing building, Station 30+57, 127' LT – 350' RT. The existing communication facilities between the existing station and east platform that are impacted by construction will be adjusted by the contractor in accordance with the plans and specifications. Maintain the existing service to the east platform and lighting during construction.

GMIA – Sanitary: Existing sanitary sewer facilities are located north/south along the Access Road and turning northeast to the existing station building, Station 29+73 – Station 30+50, 16'-50' LT. The existing sanitary facilities will remain. Construct the required sanitary service to the east and west tower in accordance with the plans and specifications. Maintain the existing service during construction.

GMIA – Water: Existing water facilities are located along the Access Road and turning northeast to the existing station building, Station 30+20 – Station 30+65, 17'-67' LT. The existing water facilities will remain. Construct the required water service to the east and west tower in accordance with the plans and specifications. Maintain the existing service during construction.

MCI Communications Services LLC (Verizon) – Communications has existing communication facilities within the project limits.

The existing underground fiber optic facilities parallel and west of Track 2, Station 98+00 – Station 108+00, 9'-11' LT will remain. Install the west platform piling to avoid conflicts. Contact MCI five business days before conducting any work near these facilities. Coordinate with MCI for on-site monitoring by an MCI representative during construction of the west platform piling and any work near these facilities.

Rogers Telecom – Communications has existing communication facilities within the project limits.

The existing underground communication facilities parallel and east of Track 1, Station 98+00 – Station 108+00, 22'-25' RT will be relocated. The new facility will be installed under the existing east platform from Track 1, Station 98+00 - Station 108+00, 9'-19' RT. The work is anticipated to be completed prior to construction.

WE Energies – Electric has existing electric facilities within the project limits.

The existing underground electric facilities are located north/south along the Access Road and turning northeast to the existing station building, Station 26+65 – Station 30+50, 10'-30' LT; parallel to the Access Road Station 31+25 – Station 33+00, 16'-40' LT; and parallel and west of Tack 1, Station 98+00 – Station 104+28, 75'-97' RT. The existing facilities will remain in place without adjustment. A new electric service to the east tower will be installed by WE Energies. Coordinate with WE Energies in advance for the schedule of the new service.

WE Energies – Gas has existing gas facilities within the project limits.

The existing underground gas facilities are located north/south along the Access Road and turning northeast to the existing station building, Station 26+65 – Station 30+50, 10'-30' LT. The existing facilities will remain in place without adjustment. A new gas service to the east tower will be installed by WE Energies. Coordinate with WE Energies in advance for the schedule of the new service.

8. Railroad Insurance and Coordination - Soo Line Railroad Company (CP).

A Description

Comply with standard spec 107.17 for all work affecting Soo Line Railroad Company (CP) property and any existing tracks.

A.1 Railroad Insurance Requirements

In addition to standard spec 107.26, provide railroad protective liability insurance coverage as specified in standard spec 107.17.3.

Revised standard spec 107.26(1) to the following:

(1) Before the state issues its notice to proceed to the contractor or contractors (collectively, the contractor) awarded the contract for construction involving the project described in this stipulation (the project), the state shall require the contractor to provide certain insurance coverage to protect the railroad (as defined in this section) from loss for property and liability exposures relating to the construction activities on the project.

The manner and process in which this will be accomplished is as detailed below:

TYPE OF INSURANCE	MINIMUM LIMITS REQUIRED
1. Commercial general liability insurance; shall be endorsed to include blanket contractual liability coverage; shall cover bodily injury and property damage, personal and advertising injury, and fire legal liability. There shall be no endorsements limiting coverage for the work to be performed pursuant to this Stipulation.	\$5,000,000 combined single limits per occurrence with an aggregate limit of not less than \$10,000,000.
2. Workers' compensation and employer's liability coverage.	Workers' compensation limits: Statutory limits. Employers' liability limits: Bodily injury by accident: \$100,000 each accident. Bodily injury by disease: \$500,000 each accident \$100,000 each employee
3. Commercial automobile liability insurance; shall cover all owned, non-owned, and hired vehicles used by the contractor in carrying out the contract, and shall include coverage for bodily	\$1,000,000 combined single limit per occurrence.
4. Railroad Protective Liability Insurance, issued on a standard ISO form 00 35 10 93 or its equivalent and endorsed to include the Pollution Exclusion Amendment (ISO form CG 28 31 10 93) and the Limited Seepage and Pollution Endorsement. No endorsements restricting FELA coverage may be added.	\$5,000,000 per occurrence \$10,000,000 in the aggregate

¹ As used in this section, "STATE" and "COMPANY" have the meanings assigned to them in the Stipulation to which this Exhibit is attached, "FELA" means the Federal Employment Liability Act, and "this Stipulation" means the Stipulation to which this Exhibit is attached.

² The contractor may satisfy the requirements for insurance types 1, 2 and 3 through primary insurance coverage or through excess/umbrella policies.

Notify evidence of the required coverage, and duration to Brian Osborne, Manager Public Works; Canadian Pacific Plaza, 120 South 6th Street, Suite 700, Minneapolis, MN 55402; Telephone (612) 330-4555; E-mail: brian_osborne@cpr.ca.

Also send a copy to the following: Jason Kazmierski, SE Region Railroad Coordinator, 141 N. Barstow Street, Waukesha, WI 53188; Telephone (262) 548-6700; E-mail jason.kazmierski@dot.wi.gov.

Include the following information on the insurance document:

- Project ID: 1000-57-70
- Project Location: Milwaukee, Wisconsin
- Route Name: Milwaukee Airport Rail Station, Milwaukee County
- Closest Crossing ID: 393023R
- Railroad Subdivision: C&M Subdivision
- Railroad Milepost: 0078.000
- Work Performed: Build platform west of existing tracks. Install of underdrain along west side of track. Construct pedestrian overpass with towers.

A.2 Train Operation

Approximately 16 passenger trains and 36 through freight trains operate daily through the construction site. Passenger trains operate at up to 79 mph. Through freight trains operate at up to 60 mph. No switching movements.

A.3 Names and Addresses of Railroad Representatives for Consultation and Coordination

Construction Contact

Brian Osborne, Manager Public Works; Canadian Pacific Plaza, 120 South 6th Street, Suite 700, Minneapolis, MN 55402; Telephone (612) 330-4555; E-mail brian_osborne@cpr.ca for consultation on railroad requirements during construction.

Amend standard spec 108.4 to include the railroad in the distribution of the initial bar chart, and monthly schedule updates. The bar chart shall specifically show work involving coordination with the railroad.

Flagging Contact

Greda Lynn, Grade Crossing Coordinator; Canadian Pacific Plaza, 120 South 6th Street, Suite 700, Minneapolis, MN 55402; Telephone (612) 258-6619; E-mail greda_lynn@cpr.ca a minimum of 40 working days in advance to arrange for a railroad flagger. Reference the Crossing ID, Wisconsin Milepost and Subdivision found in A.1.

* Contact SOO Line (CP) prior to letting for flagman work hour availability.

Cable Locate Contact

In addition to contacting Diggers Hotline, contact CP Call Before You Dig line at (866) 291-0741, five working days before the locate is needed. Reference the Crossing ID, Wisconsin Milepost and Subdivision found in A.1.

SOO Line (CP) will only locate railroad owned facilities located in the railroad right-of-way. The railroad does not locate any other utilities.

A.4 Work by Railroad

The railroad will perform the work described in this section, except for work described in other special provisions and will be accomplished without cost to the contractor. Soo Line (CP) will resurface track from approximately station 98+00 to 108+00 prior to construction. Soo Line (CP) will also construct a new emergency at-grade crossing located at station 107+83.41 and in between the platforms as shown in the plans.

Amend standard spec 108.4 to include the railroad in the distribution of the initial bar chart, and monthly schedule updates. The bar chart shall specifically show work involving coordination with the railroad.

A.5 Temporary Grade Crossing

If a temporary grade crossing is desired, submit a written request to the railroad representative named in A.3 at least 40 days prior to the time needed. Approval is subject to the discretion of the railroad. The department has made no arrangements for a temporary grade crossing.

A.6 Contractor Right of Entry

The contractor will be required to obtain a Right of Entry from Soo Line Railroad Company (CP) prior to working on railroad right of way. Contact the person in A.1 Railroad Insurance Requirements at least 30 days prior to start of work. The Right of Entry will be issued at no cost to the contractor. If the contractor pays for the Right of Entry, it will not be reimbursed by the project. The Project ID will serve as the ROE permit number unless otherwise stated.

B Railroad Flagging

Arrange with the railroad for the flagging of trains and safety of railroad operations if clearances specified in standard spec 107.17.1 are not maintained during construction operations. At any other time in railroad representative's judgment, the contractor's work or operations constitute an intrusion into the track zone and create an extraordinary hazard to railroad traffic, and at any other time when flagging protection is necessary for safety to comply with the operating rules of the railroad.

Projects with concurrent activity may require more than one flagger.

Projects with heavy contractor activity within 25 feet of the centerline of any track or unusual or heavy impact on railroad facilities will normally require a full-time flagger.

The department and railroad will monitor operations for compliance with the above flagging requirements. Violations may result in removal from railroad property until arrangements to adhere to the flagging requirements are satisfied. If the railroad imposes additional flagging requirements beyond the above flagging requirements due to the previous violations, the contractor shall bear all costs of the additional flagging requirements.

C Flagging by Railroad– Railroad Does Not Pay Flagging Costs

C.1 General

Replace paragraph (1,3 and 4) of standard spec 107.17.1 with the following:

- (1) Coordinate with the railroad for all work performed within 25 feet of the track centerline including equipment or extensions of equipment that can fall within 25 feet of the track centerline or adjacent facilities or when working on railroad right-of-way. Include the following on all submittals and other written communications with the railroad:
 - WisDOT crossing number.
 - Railroad milepost.
 - Railroad subdivision.
- (3) Perform all work within 25 feet of the track centerline including equipment or extensions of equipment that can fall within 25 feet of the track centerline or adjacent facilities or when working on railroad right-of-way in a way that does not interfere with the safe and uninterrupted operation of railroad traffic. Maintain clearances during construction as follows:
 1. Do not operate equipment closer than 25 feet horizontally from a track centerline or 22 feet vertically above the top of a rail, except under the protection of railroad flaggers.
 2. Do not store materials or equipment closer than 25 feet horizontally from a track centerline.
 3. Provide an obstruction-free work zone adjacent to a track extending 12 feet or more horizontally on both sides of the track centerline. Keep this work zone free of construction debris.
 4. Unless the railroad's chief engineering officer approves otherwise in writing, maintain minimum clearances from falsework, forms, shoring, and other temporary fixed objects as follows:
 - 4.1 Provide 12 feet, plus 1.5 inches per degree of track curvature, measured horizontally from the track centerline.
 - 4.2 Provide 21 feet, plus compensation for super-elevated track, measured vertically above the top of the highest rail.
- (4) Comply with the railroad's rules and regulations when work is within 25 feet of the track centerline including equipment or extensions of equipment that can fall within 25 feet of the track centerline or adjacent facilities or when working on railroad right-of-way. If the railroad's chief engineering officer requires, arrange with the railroad to obtain the services of qualified railroad employees to protect

railroad traffic through the work area. Bear the cost of these services and make payment directly to the railroad. Notify the appropriate railroad representative as listed in section A.3 above, in writing, at least 40 business days before starting work near a track. Provide the specific time planned to start the operations.

C.2 Rates - Soo Line Railroad Company (CP)

The following rates, reimbursement provisions, and excluded conditions will be used to determine the contractor's cost of flagging:

- \$1,200 daily rate for an eight-hour day (including wages, labor surcharges, meals, lodging, vehicle and mileage expenses),
- \$1,500 daily rate for an eight-hour day on Saturdays, Sundays or holidays (including wages, labor surcharges, meals, lodging, vehicle and mileage expenses),
- \$151 per hour overtime rate for all time worked before or after the regular assigned eight hours on any day, or for a minimum three hour call on Saturdays, Sundays, or Holidays.

If a flagger must be relieved due to hours of service requirements, arrangements will be made for a relief flagger.

The flagger is required to set flags each day in advance of the contractor commencing work that will require flagging. The flagger must also remove the flags each day after the completion of work that required flagging. Any time worked before or after the minimum eight-hour flagging day to set or remove flags will be billed at the overtime rate. The contractor is responsible for knowing the requirements of the railroad for arranging and terminating flagging services and for the associated costs of those services.

C.3 Reimbursement Provisions

The actual cost for flagging will be billed by the railroad. After the completion of the work requiring flagging protection as provided in section B above, the department will reimburse 50% of the cost of such services up to the rates provided above based on paid railroad invoices, except for the excluded conditions enumerated below. In the event actual flagging rates exceed the rates stated above, the department will reimburse 100% of the portion of the rate that is greater than the rates stated above.

C.4 Excluded Conditions

The department will not reimburse any of the cost for additional flagging attributable to the following:

1. Additional flagging requirements imposed by the railroad beyond the flagging requirements provided in subsection B above due to violations by the contractor.
2. Temporary construction crossings arranged for by the contractor.

The contractor shall bear all costs of the additional flagging requirements for the excluded conditions.

C.5 Payment for Flagging

The department will pay for the department's portion of flagging reimbursement as specified in section C of this provision under the following item:

ITEM NUMBER	DESCRIPTION	UNIT
801.0117	Railroad Flagging Reimbursement	DOL

The reimbursement payment, as shown on the Schedule of Items, is solely for department accounting purposes. Actual flagging costs will vary based on the contractor's means and methods.

Railroads may issue progressive invoices. Notify the railroad when the work is completed and request a final invoice from the railroad. Promptly pay railroad-flagging invoices, less any charges that may be in dispute. The department will withhold flagging reimbursement until any disputed charges are resolved and the final invoice is paid. No reimbursement for flagging will be made by the department if a violation of subsection B is documented.

D Rail Security Awareness and Contractor Orientation

Prior to entry on railroad right-of-way, the contractor shall arrange for on-line security awareness and contractor orientation training and testing and be registered through "e-RAILSAFE" for all contractor and subcontractor employees working on railroad right-of-way. See e-railsafe.com "Information". The security awareness and contractor orientation training are shown under the railroad's name.

The security awareness and contractor orientation certification is valid for 2 year(s) and must be renewed for projects that will carry over beyond the 2 year period. Contractor and subcontractor employees shall wear the identification badge issued by e-RAILSAFE when on railroad right-of-way. Costs associated with training and registration are incidental to other items in the contract.

9. Public Convenience and Safety.

Revise standard spec 107.8(6) as follows:

Check for and comply with local ordinances governing the hours of operation of construction equipment. Do not operate motorized construction equipment from 9:00 PM until the following 7:00 AM, unless prior written approval is obtained from the engineer.

stp-107-001 (20060512)

10. Environmental Protection, Aquatic Exotic Species Control.

Exotic invasive organisms such as VHS, zebra mussels, purple loosestrife, and Eurasian water milfoil are becoming more prolific in Wisconsin and pose adverse effects to waters of the state. Wisconsin State Statutes 30.07, "Transportation of Aquatic Plants and Animals; Placement of Objects in Navigable Waters", details the state law that requires the removal of aquatic plants and zebra mussels each time equipment is put into state waters.

At construction sites that involve navigable water or wetlands, use the follow cleaning procedures to minimize the chance of exotic invasive species infestation. Use these procedures for all equipment that comes in contact with waters of the state and/or infested water or potentially infested water in other states.

Ensure that all equipment that has been in contact with waters of the state, or with infested or potentially infested waters, has been decontaminated for aquatic plant materials and zebra mussels before being used in other waters of the state. Before using equipment on this project, thoroughly disinfect all equipment that has come into contact with potentially infested waters. Guidelines from the Wisconsin Department of Natural Resources for disinfection are available at:

<http://dnr.wi.gov/topic/invasives/disinfection.html>

Use the following inspection and removal procedures:

1. Before leaving the contaminated site, wash machinery and ensure that the machinery is free of all soil and other substances that could possibly contain exotic invasive species;
2. Drain all water from boats, trailers, bilges, live wells, coolers, bait buckets, engine compartments, and any other area where water may be trapped;
3. Inspect boat hulls, propellers, trailers and other surfaces. Scrape off any attached mussels, remove any aquatic plant materials (fragments, stems, leaves, seeds, or roots), and dispose of removed mussels and plant materials in a garbage can before leaving the area or invested waters; and
4. Disinfect your boat, equipment and gear by either:
 - 4.1. Washing with ~212 F water (steam clean), or
 - 4.2. Drying thoroughly for five days after cleaning with soap and water and/or high pressure water, or
 - 4.3. Disinfecting with either 200 ppm (0.5 oz per gallon or 1 Tablespoon per gallon) Chlorine for 10-minute contact time or 1:100 solution (38 grams per gallon) of Virkon Aquatic for 20- to 30-minute contact time. Note: Virkon is not registered to kill zebra mussel veligers nor invertebrates like spiny water flea. Therefore, this disinfect should be used in conjunction with a hot water (>104° F) application.

Complete the inspection and removal procedure before equipment is brought to the project site and before the equipment leaves the project site.

stp-107-055 (20130615)

11. Sanitary Sewer and Water Main Construction

General Mitchell International Airport (Sanitary Sewer) has underground facilities within the project limits. The contractor will install approximately 170 feet of sanitary sewer pipe, a manhole at Station 00+60, 19' LT, PARKING LOT (alignment), and connect into an existing sanitary manhole at Station 00+03, 23' LT, PARKING LOT (alignment) in accordance with the plans and specifications.

Municipality Acceptance of Sanitary Sewer and Water Main Construction.

The department, General Mitchell International Airport, and the City of Milwaukee personnel will inspect construction of sanitary sewer and water main under this contract. Provide a minimum 72-hour notice prior to any work General Mitchell International Airport and the City of Milwaukee will be inspecting to ensure adequate coverage by staff.

Sanitary Sewer and Water Main

All sanitary sewer work shall be completed according to "Standard Specifications for Sewer and Water Construction in Wisconsin," Sixth Edition, dated December 22, 2003, including all Addendum thereto.

- a) State of Wisconsin, Department of Transportation, Standard Specifications for Highway Structure Construction, 2023 Edition
- b) Wisconsin Administrative Code
- c) Standard Specifications for Sewer & Water Construction in Wisconsin, latest Edition DNR Chapter 110, Sewerage Systems
- d) Wisconsin Construction Site Best Management Practice Handbook, DNR

12. Notice to Contractor -- Federal Aviation Administration Coordination.

A determination letter addressing the use of temporary cranes for construction has been issued from the Federal Aviation Administration (FAA) for this project. Comply with all requirements of the FAA Determination letter. Review the determination letter prior to preparing bids. Copies of the FAA determination letter are available from the regional office by contacting Chris Hager at (414) 750-1487.

13. Removing Landscaping Boulders, Item 204.9060.S.

A Description

This special provision describes removing Landscaping Boulders conforming to standard spec 204.

B (Vacant)

C (Vacant)

D Measurement

The department will measure Removing Landscaping Boulders by each unit, acceptably completed.

E Payment

Add the following to standard spec 204.5:

ITEM NUMBER	DESCRIPTION	UNIT
204.9060.S	Removing Landscaping Boulders	EACH
stp-204-025 (20150630)		

14. Removing Bollards, Item 204.9060.S.

A Description

This special provision describes removing bollard conforming to standard spec 204.

B (Vacant)

C Construction

Remove the bollard and concrete base. Clean area of debris. Place asphaltic surface in exposed base area and grade to match existing adjacent pavement elevations.

D Measurement

The department will measure Removing Bollard by each individual unit, acceptably completed.

E Payment

The department will pay for measured quantities at the contract unit price under the following bid item.

ITEM NUMBER	DESCRIPTION	UNIT
204.9060.S	Removing Bollards	EACH

Payment is full compensation for removing bollard and base, sawcutting, cleaning debris, procuring and placing temporary asphalt, and disposing of waste material.

15. Select Borrow, Item 208.1100.

Conform to standard spec 208 as modified in this special provision.

Material

Furnish and use material that consists of granular material meeting the following requirements: Utilize Grade 2 granular backfill material, conforming to standard spec 209.2.

stp-208-005 (20031103)

16. QMP Drilled Shafts

A General

This special provision describes performing work conforming to standard spec 501, 502, 701, 710, and 715 (conform to QMP Concrete Structures) except as deleted or additionally stipulated herein. This specification applies to all drilled shaft concrete placed under the following bid items:

SPV.0090.02	Drilled Shaft Canopy Foundations 24-Inch
-------------	--

B Materials

B.1 Concrete Mix Physical Requirements

Use high compressive strength concrete for drilled shaft construction and relatively high cement content in the concrete mix with 590 to 675 pounds of cement per cubic yard. Additives or admixtures, when they are used, shall be clearly indicated. The concrete shall be a flowable, non-segregating concrete mix that does not exhibit rapid slump loss.

Unit Weight of Concrete, AASHTO T 121: Weight must be between 140 to 160 lb/ft³.

Fine and course aggregate shall conform to the requirements of standard spec 501.2.5 except as modified herein.

Fine aggregate shall conform to the following gradation requirements:

Sieve Size	Percent Passing (by weight)
3/8"	100
No. 4	90 – 100
No. 16	45 – 85
No. 50	5 – 30
No. 100	0 – 10
No. 200	0 – 3.5

Coarse aggregates shall conform to the following gradation requirements:

Sieve Size	Percent Passing (by weight)
1/2"	100
3/8"	85 – 100
No. 4	10 – 30
No. 8	0 – 10
No. 16	0 – 5
No. 200	0 – 1.5

Any chemical admixture(s) to be used, other than air-entraining agents or water reducers from the department approved list, must be approved in advance by the engineer and meet the requirements of AASHTO M 194, as documented by independent laboratory test reports.

The adjustment of dosage rates of concrete admixtures will be permitted without requiring a new mix design.

B.2 Slump

The trial mix design for drilled shaft concrete shall include a Slump Loss Graph, or Slump versus Time after Batching. The Slump Loss Graph of a proposed drilled shaft mix design shall illustrate the slump reducing slowly and still exceeding a 5-inch slump two hours after batching. Careful attention to concrete mix designs made with retarders must be exercised. Monitor slump to assure that all concrete placement is completed before any mix begins setting. Operations may need to be adjusted to reduce the number of shafts that are completed during a single pour event.

Adding water to a ready-mix truck is prohibited. In cases in which part of the water of the concrete mix is added at the batch plant and the remaining water is added at the job site, the amount of water to be added at the job site shall be stated on the mix design sheet carried by the ready-mix truck driver. Testing of concrete will then be conducted on the resulting mix, and further water cannot be added at any time to increase the mix slump or to bring the mix to a specific slump. If after all the water permitted in the mix design has been added and the slump is still out of these specifications, the contractor must reject the mix. Repair or replace drilled shafts of questionable concrete design mixes at no additional cost to the department.

The following table presents the ranges for the slump.

	Slump Range in Inches		
	Concrete Placed by Free Falling	Concrete Placed by Tremie	Concrete Placed by Pump
Dry Installation Method			
Uncased or Cased Excavations	7 to 9	8 to 9½	7 to 9½
Wet Installation Method			
Uncased or Cased Excavations	N/A	8 to 9½	7 to 9½

B.3 Slurry

B.3.1 General

Slurry shall be a stable suspension of mineral in potable water or polymer slurry. Maintain a stable suspension at all times. Bentonite slurry shall be mineral slurry of powdered Wyoming or Dakota bentonite, with density, viscosity, and pH as specified in the table below:

Property at 68°F Units	At the Time of Slurry Introduction into the Drilled Shaft	Before Concrete Placement in the Drilled Shaft	Test Method
Density in Fresh Water (lb/ft ³) (a)	64 to 69	64 to 75	Density Balance
Viscosity (seconds per quart)	28 to 45	28 to 45	Marsh Funnel
pH	7 to 11	7 to 11	pH paper or meter
Sand Content (%) (b)	4 maximum	10 maximum	200 Sieve Retain

- (a) At time of concreting, sand content shall not exceed 10 percent (by volume) at any point in the drilled shaft excavation; test for sand content as determined by the American Petroleum Institute.
- (b) Bentonite slurry shall be disposed of offsite in an approved manner as accepted by the WDNR.

The contractor may adjust the range of slurry properties when field trials and field tests show that modifications are necessary to bring the slurry to specifications.

Polymer slurry shall be a suspension of powdered polyacrylamide or vinyl polymer with the following characteristics:

Property at 68°F Units	At the Time of Slurry Introduction into the Drilled Shaft	Before Concrete Placement in the Drilled Shaft	Test Method
Density in Fresh Water (lb/ft ³) (a)	63 or less	63 or less	Density Balance
Viscosity (seconds per quart)	50 minimum	50 minimum	Marsh Funnel
pH	8 to 11	8 to 11	pH paper or meter
Sand Content (%)	2 maximum	10 maximum	200 Sieve Retain

- (a) At time of concreting, sand content shall not exceed 10 percent (by volume) at any point in the drilled shaft excavation; test for sand content as determined by the American Petroleum Institute.

Obtain slurry samples from the midpoint and bottom of each drilled shaft prior to the placement of the reinforcing steel. Correct the slurry as necessary to meet the specification requirements.

B.3.2 Tests

To ensure that the results are within the ranges stated in the table above, perform the following tests on the mineral slurry supplied to the drilled shaft excavation at different depths within the drilled shaft using a slurry sampler.

B.3.2.1 Wisconsin Method of Test for Density of Slurry (Mud Weight)

Density shall be measured at 68°F. This test is identical to ASTM D 4380 except that the mineral slurry to be tested shall consist of processed attapulgite or bentonite clays, and the temperature of the slurry (using a 0-105°C thermometer) shall be measured and recorded on the drilling Mud Report form.

B.3.2.2 Wisconsin Method of Test for Viscosity of Slurry

The viscosity shall be measured at 68°F or a constant temperature with the Marsh Cone Method.

1. Scope

The Marsh Funnel or Marsh Cone is used to measure viscosity of drilling fluids. This test method has been adapted from Section 2 of the American Petroleum Institute (API) Recommended Practice FM8-RP13B-1: Standard Procedure for Field Testing Water-Based Drilling Fluids (FM 8-RP13B-1). Use of a direct-reading viscometer has been eliminated.

2. Equipment

Marsh Funnel: A Marsh Funnel is calibrated to out-flow 946 mL (one quart) of fresh water at a temperature of 21 ±3°C (70 ±5°F) in 26 ±0.5 seconds. A graduated cup is used as a receiver.

Specifications:

Funnel Cone Length	305 mm (12.0 in.)
Diameter	152 mm (6.0 in.)
Capacity to bottom of screen	1500 mL
Orifice Length	50.8 mm (2.0 in.)
Inside Diameter	4.7mm (3/16 in.)
Screen	12 mesh

Has 1.6 mm (1/16 in.) openings and is fixed at a level 19.0 mm (3/4 in.)

B.3.2.3 Wisconsin Method of Test for Sand Content of Slurry

1. Scope

The sand content of mud is the volume percent of particles larger than 74 microns. It is measured by a sand-screen set. This test method has been adapted from Section 5 of the American Petroleum Institute (API) Recommended Practice 13B-1: standard Procedure for Field Testing Water-Based Drilling Fluids (RP13B-1).

2. Equipment

200-mesh sieve, 63.5 mm (2.5 in.) in diameter.

Funnel to fit sieve.

Glass measuring tube marked for the volume of mud to be added. The tube is graduated from 0 to 20 percent in order to read directly the percentage of sand.

3. Procedure

Fill the glass measuring tube with mud to the "mud" mark. Add water to the next mark. Close the mouth of the tube and shake vigorously. Pour the mixture onto the clean, wet screen. Discard the liquid passing through the screen. Add more water to the tube, shake, and again pour onto the screen. Repeat until the tube is clean. Wash the sand retained on the screen to free it of any remaining mud.

Put the funnel upside down over the top of the sieve invert. Slowly tip the assembly and insert the tip of the funnel into the mouth of the glass tube. Wash the sand into the tube by playing a fine spray of water through the screen. Allow the sand to settle. From the graduations on the tube, read the volume percent of the sand.

Report the sand content of the mud by percent volume. Report the source of the mud sample, i.e. above shaker, suction pit, etc. Coarse solids other than sand will be retained on the screen (e.g., lost circulation material) and the presence of such solids should be noted.

B.3.2.4 Wisconsin Method of Test for pH of Slurry

pH shall be measured by the Electric pH meter or pH indicator paper strips.

1. Scope

Field measurement of drilling fluid (or filtrate) pH and adjustments to the pH are fundamental to drilling fluid control. This test method has been adapted from Section 7 of the American Petroleum Institute (API) Recommended Practice 13B-1: Standard Procedure for Field Testing Water-Based Drilling Fluids (RP 13B-1).

The recommended method for pH measurement of drilling fluid is with a glass electrode pH meter. This method is accurate and gives reliable pH values, being free of interference if a high quality electrode system is used with a properly designed instrument. Rugged pH instruments are available that automatically temperature compensate the slope and are preferred over the manually adjusted instruments.

NOTE: Color matching pH paper and sticks are used for field pH measurements but are not the methods recommended. These methods are reliable only in very simple water muds. Mud solids, dissolved salts and chemicals, and dark-colored liquids cause serious errors in pH paper values. Readability is normally about 0.5 pH unit.

2. Equipment

pH meter: millivolt range potentiometer calibrated to show pH units for measuring the potential between a glass-membrane electrode and a standard "reference" electrode. The instrument is (preferred) to be water, shock, and corrosion-resistant and portable. Specifications are:

pH range: 0 to 14.

Electronics type: solid state (preferred).

Power source: batteries (preferred).

Operating temperature range: 0-66°C (32-150°F).

Readout: digital (preferred).

Resolution: 0.1 pH unit.

Accuracy: ± 0.1 pH unit.

Repeatability: 0.1 pH unit.

Adjustments.

"Temperature" compensation of electrode system.

"Slope" of electrode system (preferred).

"Calibration" setting of readout. (Instrument with the above internal temperature compensation is preferred.)

Electrode system: A combination system of a glass electrode for sensing H⁺ ions and a standard voltage reference electrode, constructed as a single electrode (preferred). Body of this probe should be constructed of durable material. A flat-end probe is preferred for better protection and easier cleaning of the electrode. Waterproof connection to the meter is recommended. Specifications are:

Glass pH electrode response range: 0 to 14 pH unit.

Electrodes: a glass electrode and a silver/silver chloride electrode in combination, having a ceramic or a plastic single or double junction.

Electrolyte in reference electrode: KCl gel.

Glass composition: suitable for low sodium ion error.

Sodium ion error: at pH = 13 or at 0.1 mole Na⁺ ion, an error less than 0.1 pH unit.

Buffer solutions: three solutions to calibrate and set slope of pH meter prior to sample measurement.

pH = 4.0: potassium hydrogen phthalate at 0.05 molar in water. Gives 4.01 pH at 24°C (75°F).

pH = 7.0: potassium dihydrogen phosphate at 0.02066 molar and disodium hydrogen phosphate at 0.02934 molar in water. Gives 7.00 pH at 24°C (75°F).

pH = 10.0: sodium carbonate at 0.025 molar and sodium bicarbonate at 0.025 molar in water. Gives 10.01 pH at 24°C (75°F).

NOTE: Buffers may be obtained from supply houses as pre-made solution, dry-powder packages, or a given formula, but must duplicate National Bureau of Standards primary or secondary buffers. Shelf life of all buffers not to exceed six months. Date of preparation of buffer should be shown on bottles used in the field. Bottles should be kept tightly stoppered.

Distilled or deionized water: in spray bottle.

Soft tissues: to blot electrodes.

Thermometer: glass, 0-150°C (32-220°F).

Accessory equipment: Soft-bristle test tube brush: to clean electrode.

Mild liquid detergent: Ivory, or equivalent.

Electrode storage vial: to keep electrode moist.

Sodium hydroxide: 0.1 molar (approximately); to recondition electrode.

Hydrochloric acid: 0.1 molar (approximately); to recondition electrode.

Ammonium bifluoride: 10% solution (approximately); to recondition electrode.

CAUTION: This is a strong and toxic acid.

Hydrofluoric acid: ACS reagent grade.

CAUTION: This is a strong acid.

3. Procedure – pH Measurement

Obtain sample of fluid to be tested. Allow it to reach $24\pm 3^\circ\text{C}$ ($75\pm 5^\circ\text{F}$). Allow buffer solution to also reach the same temperature as the fluid to be tested.

NOTE: For accurate pH measurement; the test fluid, buffer solution, and reference electrode must all be at the sample temperature. The pH of the buffer solution indicated on the container label is the correct pH only at 24°C (75°F). If attempting to calibrate at another temperature, the actual pH of the buffer at this temperature must be used. Tables of buffer pH values at various temperatures are available from the suppliers and should be used in the calibration procedure.

Clean electrodes by washing with distilled water and blot dry. Place probe into pH 7.0 buffer.

Turn on meter; wait 60 seconds for reading to stabilize. Measure temperature of pH 7 buffer solution. Set this temperature on “temperature” knob. Set meter reading to “7.0” using “calibration” knob. Rinse probe with distilled water and blot dry.

Repeat operations using either pH 4.0 or pH 10.0 buffer. Use pH 4.0 if “acidic” sample, or pH 10.0 if “alkaline” sample is to be tested. Set meter to number “4.0” or “10.0” respectively, using “slope” adjustment knob. (If no “slope” knob exists, use the “temperature” knob to set “4.0” or “10.0” on meter). Check the meter with pH 7 buffer again. If it has changed, reset to “7.0” with “calibration” knob. Repeat procedures to ensure equipment is properly calibrated.

NOTE: Discard and do not reuse the sample of buffer solutions used in calibration. Meter should be fully calibrated every day using two buffers. Check with pH 7 buffer every three hours. If meter calibrates properly, rinse electrode with distilled water and blot dry. Place electrode in sample to be tested and stir gently. Allow 60 to 90 seconds for reading to stabilize.

Record sample pH to nearest 0.1 pH unit and the temperature of sample tested. Carefully clean the electrode in preparation for next usage. Store in vial of pH 4 buffer. NEVER let the probe tip become dry. Turn meter off and close cover to protect instrument. Avoid storing instrument at extreme temperatures (below 0°C (32°F) or above 49°C (120°F)).

Care of Electrode: Cleaning the electrode will be necessary periodically, especially if oil or clay particles coat the face of the glass electrode or the porous frit of the reference electrode. Clean electrode with a

soft-bristle brush and a mild detergent. Reconditioning the electrode may be necessary if plugging becomes severe, as indicated by slow response, drifting of readings, or if “slope” and “calibration” cannot be mutually set. Recondition by soaking electrode for 10 minutes in 0.1 M HCl followed by rinsing in water and soaking for 10 minutes in 0.1 M NaOH and rinsing again. Check electrode for response by performing calibration. If electrode continues to perform poorly, soak electrode for two minutes only in 10% NH₄F · HF solution. (CAUTION: This is strong and toxic acid). Replace electrode system if above steps fail to recondition it.

C (Vacant)

D (Vacant)

E Payment

E.1 QMP Drilled Shafts

Costs for all sampling, testing, and documentation required under this special provision and all other associated work are incidental to the work.

17. Cover Plates Temporary, Item 611.8120.S.

A Description

This special provision describes providing and removing steel plates to cover and support asphaltic pavement and traffic loading at manholes, inlets and similar structures during milling and paving operations.

B Materials

Provide a 0.25 inch minimum thickness steel plate that extends to the outside edge of the existing masonry.

C (Vacant)

D Measurement

The department will measure Cover Plates Temporary as each individual unit, acceptably completed.

E Payment

The department will pay for measured quantities at the contract unit price under the following bid item:

ITEM NUMBER	DESCRIPTION	UNIT
611.8120.S	Cover Plates Temporary	EACH

Payment is full compensation for furnishing, installing, and removing the cover plates.

The steel plates shall become the property of the contractor when no longer needed in the contract work.

stp-611-006 (20151210)

18. Tracer Wire 12 AWG.

Add to standard spec 612.3:

The contractor shall install a 12 AWG XLP insulated, solid, copper, yellow in color tracer wire, conforming to the requirements of standards spec 655, on each run of underdrain. The wire shall be approximately 5 feet (1.5 m) longer than the run of underdrain and shall be doubled back at least 2 feet (0.6 m) at each raceway access point. Anchor the tracer wire at each access point in a manner acceptable to the engineer. At each access point, the wires from all underdrain entering shall be twisted and joined using an appropriately sized wire nut.

19. Underdrain Cleanout

Add to standard spec 612.3:

The contractor shall install a pipe underdrain cleanout conforming to the details and locations specified in the plans. At specified locations, provide a 45 degree, smooth or corrugated HDPE wye connection with couplers to pipe or cap. Cleanout should be installed flush with finished grade at ground level.

20. Fence Safety, Item 616.0700.S.

A Description

This special provision describes providing plastic fence at locations the plans show.

B Materials

Furnish notched conventional metal "T" or "U" shaped fence posts.

Furnish fence fabric meeting the following requirements.

Color:	International orange (UV stabilized)
Roll Height:	4 feet
Mesh Opening:	1 inch min to 3 inch max
Resin/Construction:	High density polyethylene mesh
Tensile Yield:	Avg. 2000 lb per 4 ft. width (ASTM D638)
Ultimate Tensile Strength:	Avg. 3000 lb per 4 ft. width (ASTM D638)
Elongation at Break (%):	Greater than 100% (ASTM D638)
Chemical Resistance:	Inert to most chemicals and acids

C Construction

Drive posts into the ground 12 to 18 inches. Space posts at 7 feet.

Use a minimum of three wire ties to secure the fence at each post. Weave tension wire through the top row of strands to provide a top stringer that prevents sagging.

Overlap two rolls at a post and secure with wire ties.

D Measurement

The department will measure Fence Safety by the linear foot along the base of the fence, center-to-center of posts, acceptably completed.

E Payment

The department will pay for measured quantities at the contract unit price under the following bid item:

ITEM NUMBER	DESCRIPTION	UNIT
616.0700.S	Fence Safety	LF

Payment is full compensation for furnishing and installing fence and posts; maintaining the fence and posts in satisfactory condition; and for removing and disposing of fence and posts at project completion.

stp-616-030 (20160607)

21. Seeding.

Add the following to standard spec spec 630.2.1.5.1.1:

Table 630-3 may be used for the mixtures provided in the table:

TABLE 630-3 (OPTIONAL SEED MIXTURES)

SPECIES COMMON NAME (Acceptable Varieties)	SPECIES BOTANICAL NAME	PURITY minimum %	GERMINATION minimum %	MIXTURE PROPORTIONS (in percent) Two options for each mix type							
				NO.10		NO.20		NO.30		NO.40	
				#1	#2	#1	#2	#1	#2	#1	#2
Kentucky Bluegrass (Low Maintenance)	Poa pratensis	98	85	40	42	6	6	10	13	35	35
* Red Fescue (Creeping)	Festuca rubra	97	85	10	13	5	7	15	15	10	15
Hard Fescue (Improved)	Festuca ovina var. duriuscula	97	85			24	22	25	25	20	20
Tall Fescue (Improved Turf Type)	Festuca arundinacea	98	85			40	40				
Salt Grass (Fult's or Salty)	Puccinella distans	98	85					15	15		
Redtop	Agrostis alba	92	85	5	5						
Perennial Ryegrass	Lolium perenne	96	85	25	30	25	25	25	32	25	30
White Clover	Trifolium repens	95	90	10	10						
Chewings Fescue	Festuca rubra var. commutata	98	85	10				10		10	
Sheep's Fescue	Festuca ovina	97	85								

* A blend of fescue type will be permitted to achieve the specified Red Fescue (Creeping) percentage using any of the following varieties as substitutes:

- Red Fescue (Creeping)
- Hard Fescue (Improved)
- Chewings Fescue
- Sheep's Fescue

22. Landscape Planting Surveillance and Care Cycles.

If the care specialist fails to perform any of the required care cycles as specified in standard spec 632.3.19.1, the department will assess daily damages in the amount of \$1000 for damages to cover the cost of performing the work with other forces. The department will assess these damages for each day the requirements of the care cycle remain incomplete, except when the engineer extends the required time period.

stp-632-005 (20070510)

23. Lamp, Ballast, LED, Switch Disposal by Contractor, Item 659.5000.S.

A Description

This special provision describes the detachment and packaging of lamps, ballasts, LEDs, and mercury containing switches (e.g., overhead roadway lighting, underdeck bridge, wall packs, pedestrian signals, traffic control stop lights and warning flashers, fluorescent bulbs, and thermostats) removed under this contract for disposal as hazardous materials.

For Lamp, Ballast, LED, Switch Disposal by Contractor, coordinate removal from the work site by the department's hazardous waste disposal vendor. Disposal will be billed to the department by the hazardous waste disposal vendor.

For Lamp, Ballast, LED, Switch Disposal by Department, coordinate removal from the work site and delivery to the designated location for disposal by the department.

B Materials

B.1 Disposal by Contractor

Items removed under this contract will be considered the property of the department for waste generator identification. The contractor is responsible for coordinating with the department's hazardous waste vendor for disposal:

<https://wisconsindot.gov/Documents/doing-bus/eng-consultants/cnslt-rsrces/environment/hazwaste-contacts.pdf>

B.2 Disposal by Department

Items turned in to the department will be considered the property of the department for proper future disposal, and the contractor will have no further obligation for the disposal.

C Construction

C.1 Removal

Arrange for the de-energizing of luminaires after receiving approval from the engineer that the existing luminaires can be removed. Do not remove luminaires that cannot be replaced with proposed LED units and operational within the same workday. The new LED units need to be operational prior to sunset of the same workday.

Detach and remove luminaires and lamps from the existing traffic signal poles or respective structure. Avoid breaking fixtures whenever possible.

Lamps, ballasts, LED, and switches will become property of the department, and will be disposed of in an environmentally sound manner.

C.2 Packaging of Hazardous Materials

Provide a secure, level location removed from the travelled way for storage of the material for disposal.

Pack intact fixtures in the packaging of the new lamps used to replace them, or packaging affording the equivalent protection. Place in full, closed stackable cartons.

Pile cartons no more than four high if palletized and secure cartons with shrink wrap to prevent shifting or falling of the loads. Clearly mark each pallet with the words "Universal Waste Lamps" or "Universal Waste Ballasts", the date, and the number of fixtures on each pallet.

Pack broken fixtures into (min.) 6 mil thick plastic bags and place inside sturdy cardboard boxes or the equivalent. Mark the outer packaging with the term "Broken Fixtures/Lamps", the date and the number of broken fixtures clearly marked on the box.

The hazardous waste vendor will not accept fixtures improperly packaged. The vendor will reject any fixtures not removed as part of a contract pay item or otherwise required under this contract.

Pack ballasts and mercury containing switches in appropriate containers.

C.3 Disposal by Contractor

Complete the lamp and ballast inventory (<https://wisconsindot.gov/Documents/doing-bus/eng-consultants/cnslt-rsrces/environment/dotlampballastinventory.dotx>) and contact the hazardous waste vendor to coordinate pickup and disposal at a location specified by the contractor. Consolidate all pallets and boxes from one project at a single location. Contact the hazardous waste vendor to set up an appointment for pickup. The hazardous waste vendor requires a minimum of one week advance notice to schedule pickup.

D Measurement

The department will measure Lamp, Ballast, LED, Switch Disposal by Contractor as each individual unit removed and received by the hazardous waste vendor, properly packaged and acceptably completed, matching the total number of units provided on the inventory form. The department will not measure broken fixtures that exceed a total of 10 percent of all fixtures to be disposed.

E Payment

The department will pay for measured quantities at the contract unit price under the following bid item:

ITEM NUMBER	DESCRIPTION	UNIT
659.5000.S	Lamp, Ballast, LED, Switch Disposal by Contractor	EACH

Payment for Lamp, Ballast, LED, Switch Disposal by Contractor is full compensation for detachment, handling, packaging, labeling and scheduling disposal with the hazardous waste vendor; and scrapping and disposal of all other materials.

stp-659-500 (20220628)

24. Diesel-Engine-Driven Generator Sets, Item SPV.0060.01.

A Description

This special provision describes furnishing materials necessary for the installation, testing, and making fully operational the generator for the structure. All additional special provisions provide further information, requirements, and guidelines that are applicable to the work paid for under the bid items addressed by this special provision.

Comply with all local codes, all laws applying to electrical installations in effect, the regulations of the latest National Electrical Code.

It is the intention of the contract plans to call for completely finished work, fully tested and ready for reliable and consistent operation. Furnish, deliver, and install any apparatus, appliance, materials, or work not shown on the plans but mentioned in the special provisions or vice versa, or any incidental accessories necessary to make the work complete in all respects and ready for operation, to be furnished, delivered, and installed without additional expense to the department.

Generator shall comply with Buy America Act.

B Materials

B.1 Diesel; Generator

1. General
 - a. Diesel engine.
 - b. Diesel fuel-oil system.
 - c. Control and monitoring.
 - d. Generator overcurrent and fault protection.
 - e. Generator, exciter, and voltage regulator.
 - f. Vibration isolation devices.
2. Related Requirements:
 - a. Section "Battery Chargers" for remote engine battery chargers.
 - b. Section "Transfer Switches" for transfer switches including sensors and relays to initiate automatic-starting and -stopping signals for engine generators.

B.1.2 Action Submittals

1. Product Data: For each type of product.
2. Shop Drawings:
 - a. Include plans and elevations for engine generator and other components specified. Indicate access requirements affected by height of subbase fuel tank.
 - b. Include details of equipment assemblies. Indicate dimensions, weights, loads, required clearances, method of field assembly, components, and location and size of each field connection.
 - c. Identify fluid drain ports and clearance requirements for proper fluid drain.
 - d. Design calculations for selecting vibration isolators and seismic restraints and for designing vibration isolation bases.
 - e. Vibration Isolation Base Details: Detail fabrication including anchorages and attachments to structure and to supported equipment. Include base weights.
 - f. Include diagrams for power, signal, and control wiring. Complete schematic, wiring, and interconnection diagrams showing terminal markings for engine generators and functional relationship between all electrical components.

B.1.3 Informational Submittals

1. Seismic Qualification Data: Certificates, for engine generator, accessories, and components, from manufacturer.
2. Source quality-control reports.
3. Field quality-control reports.
4. Warranty.

B.1.4 Closeout Submittals

1. Operation and maintenance data.

B.1.5 Quality Assurance

1. Installer Qualifications: An authorized representative who is trained and approved by manufacturer.
2. Testing Agency Qualifications: Accredited by NETA.
3. Testing Agency's Field Supervisor: Certified by NETA to supervise on-site testing.

B.1.6 Warranty

1. Manufacturer's Warranty: Manufacturer agrees to repair or replace components of packaged engine generators and associated auxiliary components that fail in materials or workmanship within specified warranty period.
2. Warranty Period: 5 years from date of Substantial Completion.

B.1.7 Products

1. Manufacturers
 - a. Cummins, Caterpillar, Kohler or approved equal.
 - b. Performance Requirements
 - c. Seismic Performance: Engine generator housing, subbase fuel tank, engine generator, batteries, battery racks, silencers, load banks, sound attenuating equipment, accessories, and components shall withstand the effects of earthquake motions determined according to ASCE/SEI 7.

- i The term "withstand" means "the unit will remain in place without separation of any parts when subjected to the seismic forces specified."
 - ii Shake-table testing shall comply with ICC-ES AC156. Testing shall be performed with all fluids at worst-case normal levels.
 - iii Component Importance Factor: **1.5 1.0**.
 - d. B11 Compliance: Comply with B11.19.
 - e. NFPA Compliance:
 - i Comply with NFPA 37.
 - ii Comply with NFPA 70.
 - iii Comply with NFPA 99.
 - iv Comply with NFPA 110 requirements for Level 1 EPSS.
 - v UL Compliance: Comply with UL 2200.
 - vi Engine Exhaust Emissions: Comply with EPA Tier 2 3 4 requirements and applicable state and local government requirements.
 - f. Noise Emission: Comply with applicable state and local government requirements for maximum noise level at adjacent property boundaries due to sound emitted by engine generator including engine, engine exhaust, engine cooling-air intake and discharge, and other components of installation.
 - g. Environmental Conditions: Engine generator system shall withstand the following environmental conditions without mechanical or electrical damage or degradation of performance capability:
 - i Ambient Temperature: -5 to 104 deg F.
 - ii Relative Humidity: Zero to 95 percent.
 - iii Altitude: Sea level to 1000 feet.
2. Engine Generator Assembly Description
- a. Factory-assembled and -tested, water-cooled engine, with brushless generator and accessories.
 - b. Electrical Components, Devices, and Accessories: Listed and labeled as defined in NFPA 70, by a qualified testing agency, and marked for intended location and use.
 - c. Power Rating: Standby.
 - d. Overload Capacity: 110 percent of service load for 1 hour in 12 consecutive hours.
 - e. Fuel tank: Provide dual walled subbase tank size for 48 hours of usable operating hours.
 - f. Service Load: 750 kVA / 600 kW.
 - g. Power Factor: 0.8, lagging.
 - h. Frequency: 60 Hz.
 - i. Voltage: 277/480-V ac.
 - j. Phase: Three-phase, four wire.
 - k. Governor: Adjustable isochronous, with speed sensing.
 - l. Mounting Frame: Structural steel framework to maintain alignment of mounted components without depending on concrete foundation. Provide lifting attachments sized and spaced to prevent deflection of base during lifting and moving.
 - i Rigging Diagram: Inscribed on metal plate permanently attached to mounting frame to indicate location and lifting capacity of each lifting attachment and engine generator center of gravity.

m. Capacities and Characteristics:

- i Power Output Ratings: Nominal ratings as indicated at 0.8 power factor excluding power required for the continued and repeated operation of the unit and auxiliaries, with capacity as required to operate as a unit as evidenced by records of prototype testing.
- ii Nameplates: For each major system component to identify manufacturer's name and address, and model and serial number of component.

n. Engine Generator Performance:

- i Steady-State Voltage Operational Bandwidth: 3 percent of rated output voltage from no load to full load.
- ii Transient Voltage Performance: Not more than 20 percent variation for 50 percent step-load increase or decrease. Voltage shall recover and remain within the steady-state operating band within three seconds.
- iii Steady-State Frequency Operational Bandwidth: 0.5 percent of rated frequency from no load to full load.
- iv Steady-State Frequency Stability: When system is operating at any constant load within the rated load, there shall be no random speed variations outside the steady-state operational band and no hunting or surging of speed.
- v Transient Frequency Performance: Less than 5 percent variation for 50 percent step-load increase or decrease. Frequency shall recover and remain within the steady-state operating band within five seconds.
- vi Output Waveform: At no load, harmonic content measured line to line or line to neutral shall not exceed 5 percent total and 3 percent for single harmonics. Telephone influence factor, determined according to NEMA MG 1, shall not exceed 50 percent.
- vii Sustained Short-Circuit Current: For a three-phase, bolted short circuit at system output terminals, system shall supply a minimum of 250 percent of rated full-load current for not less than 10 seconds and then clear the fault automatically, without damage to generator system components.
- viii Start Time:
 - 1) Comply with NFPA 110, system requirements.
 - 2) 10 seconds.

3. Diesel Engine

- a. Fuel: ASTM D975, diesel fuel oil, Grade 2-D S15.
- b. Rated Engine Speed: 1800 rpm.
- c. Lubrication System: Engine or skid-mounted.
 - i Filter and Strainer: Rated to remove 90 percent of particles 5 micrometers and smaller while passing full flow.
 - ii Thermostatic Control Valve: Control flow in system to maintain optimum oil temperature. Unit shall be capable of full flow and is designed to be fail-safe.
 - iii Crankcase Drain: Arranged for complete gravity drainage to an easily removable container with no disassembly and without use of pumps, siphons, special tools, or appliances.
- d. Jacket Coolant Heater: Electric-immersion type, factory installed in coolant jacket system. Comply with UL 499 and with NFPA 110 requirements for Level 1 equipment for heater capacity.

- e. Cooling System: Closed loop, liquid cooled, with radiator factory mounted on engine generator mounting frame and integral engine-driven coolant pump.
 - i. Coolant: Solution of 50 percent ethylene-glycol-based antifreeze and 50 percent water, with anticorrosion additives as recommended by engine manufacturer.
 - ii. Size of Radiator: Adequate to contain expansion of total system coolant from cold start to 110 percent load condition.
 - iii. Expansion Tank: Constructed of welded steel plate and rated to withstand maximum closed-loop coolant system pressure for engine used. Equip with gage glass and petcock.
 - iv. Temperature Control: Self-contained, thermostatic-control valve modulates coolant flow automatically to maintain optimum constant coolant temperature as recommended by engine manufacturer.
 - v. Coolant Hose: Flexible assembly with inside surface of nonporous rubber and outer covering of aging-, UV-, and abrasion-resistant fabric.
 - 1) Rating: 50-psig maximum working pressure with coolant at 180 deg F, and noncollapsible under vacuum.
 - 2) End Fittings: Flanges or steel pipe nipples with clamps to suit piping and equipment connections.
- f. Muffler/Silencer: Critical type, sized as recommended by engine manufacturer and selected with exhaust piping system to not exceed engine manufacturer's engine backpressure requirements.
 - i. Minimum sound attenuation of 25 dB at 500 Hz.
 - ii. Sound level measured at a distance of 25 feet from exhaust discharge after installation is complete shall be 78 dBA or less.
- g. Muffler/Silencer: Semicritical type, sized as recommended by engine manufacturer and selected with exhaust piping system to not exceed engine manufacturer's engine backpressure requirements.
 - i. Minimum sound attenuation of 18 dB at 500 Hz.
 - ii. Sound level measured at a distance of 25 feet from exhaust discharge after installation is complete shall be 85 dBA or less.
- h. Muffler/Silencer: Commercial type, sized as recommended by engine manufacturer and selected with exhaust piping system to not exceed engine manufacturer's engine backpressure requirements.
 - i. Minimum sound attenuation of 12 dB at 500 Hz.
 - ii. Sound level measured at a distance of 25 feet from exhaust discharge after installation is complete shall be 90 dBA or less.
- i. Air-Intake Filter: Heavy-duty, engine-mounted air cleaner with replaceable dry-filter element and "blocked filter" indicator.
- j. Starting System: 24-V electric, with negative ground.
 - i. Components: Sized so they are not damaged during a full engine-cranking cycle with ambient temperature at maximum specified in "Performance Requirements" Article.
 - ii. Cranking Motor: Heavy-duty unit that automatically engages and releases from engine flywheel without binding.
 - iii. Cranking Cycle: As required by NFPA 110 for system level specified.
 - iv. Battery: Lead acid, with capacity within ambient temperature range specified in "Performance Requirements" Article to provide specified cranking cycle at least twice without recharging.

- v Battery Cable: Size as recommended by engine manufacturer for cable length indicated. Include required interconnecting conductors and connection accessories.
- vi Battery Compartment: Factory fabricated of metal with acid-resistant finish and thermal insulation. Thermostatically controlled heater shall be arranged to maintain battery above 50 deg F regardless of external ambient temperature within range specified in "Performance Requirements" Article. Include accessories required to support and fasten batteries in place. Provide ventilation to exhaust battery gases.
- vii Battery Stand: Factory-fabricated, two-tier metal with acid-resistant finish designed to hold the quantity of battery cells required and to maintain the arrangement to minimize lengths of battery interconnections.
- viii Battery-Charging Alternator: Factory mounted on engine with solid-state voltage regulation and 35-A minimum continuous rating.
- ix Battery Charger: Current-limiting, automatic-equalizing, and float-charging type designed for lead-acid batteries. Unit shall comply with UL 1236 and include the following features:
 - 1) Operation: Equalizing-charging rate of 10 A shall be initiated automatically after battery has lost charge until an adjustable equalizing voltage is achieved at battery terminals. Unit shall then be automatically switched to a lower float-charging mode and shall continue to operate in that mode until battery is discharged again.
 - 2) Automatic Temperature Compensation: Adjust float and equalize voltages for variations in ambient temperature from minus 40 to 140 deg F to prevent overcharging at high temperatures and undercharging at low temperatures.
 - 3) Automatic Voltage Regulation: Maintain constant output voltage regardless of input voltage variations up to plus or minus 10 percent.
 - 4) Ammeter and Voltmeter: Flush mounted in door. Meters shall indicate charging rates.
 - 5) Safety Functions: Sense abnormally low battery voltage and close contacts providing low battery voltage indication on control and monitoring panel. Sense high battery voltage and loss of ac input or dc output of battery charger. Either condition shall close contacts that provide a battery-charger malfunction indication at system control and monitoring panel.
 - 6) Enclosure and Mounting: NEMA 250, Type 1, wall-mounted cabinet.

4. Diesel Fuel-Oil System

- a. Comply with NFPA 37.
- b. Piping: Fuel-oil piping shall be Schedule 40 black steel, complying with requirements in Section 231113 "Facility Fuel-Oil Piping." Cast iron, aluminum, copper, and galvanized steel shall not be used in the fuel-oil system.
- c. Main Fuel Pump: Mounted on engine to provide primary fuel flow under starting and load conditions.
- d. Fuel Filtering: Remove water and contaminants larger than 1 micron.
- e. Relief-Bypass Valve: Automatically regulates pressure in fuel line and returns excess fuel to source.
- f. Subbase-Mounted, Double-Wall, Fuel-Oil Tank: Factory installed and piped, complying with UL 142 fuel-oil tank. Features include the following:
 - i Tank level indicator.
 - ii Fuel-Tank Capacity: Minimum 133 percent of total fuel required for planned operation plus fuel for periodic maintenance operations between fuel refills.
 - iii Leak detection in interstitial space.

- iv Vandal-resistant fill cap.
 - v Containment Provisions: Comply with requirements of authorities having jurisdiction.
5. Control and Monitoring
- a. Automatic Starting System Sequence of Operation: When mode-selector switch on the control and monitoring panel is in the automatic position, remote-control contacts in one or more separate automatic transfer switches initiate starting and stopping of engine generator. When mode-selector switch is switched to the on position, engine generator starts. The off position of same switch initiates engine generator shutdown. When engine generator is running, specified system or equipment failures or derangements automatically shut down engine generator and initiate alarms.
 - b. Manual Starting System Sequence of Operation: Switching on-off switch on the generator control panel to the on position starts engine generator. The off position of same switch initiates engine generator shutdown. When engine generator is running, specified system or equipment failures or derangements automatically shut down engine generator and initiate alarms.
 - c. Provide minimum run time control set for 15 minutes with override only by operation of a remote emergency-stop switch.
 - d. Comply with UL 508A.
 - e. Configuration: Operating and safety indications, protective devices, basic system controls, and engine gages shall be grouped in a common control and monitoring panel mounted on the engine generator. Mounting method shall isolate the control panel from engine generator vibration. Panel shall be powered from the engine generator battery.
 - f. Configuration: Operating and safety indications, protective devices, basic system controls, and engine gages shall be grouped in a common wall-mounted control and monitoring panel. Panel shall be powered from the engine generator battery.
 - g. Control and Monitoring Panel:
 - i Digital engine generator controller with integrated LCD display, controls, and microprocessor, capable of local and remote control, monitoring, and programming, with battery backup.
 - ii Analog control panel with dedicated gages and indicator lights for the instruments and alarms indicated below.
 - iii Instruments: Located on the control and monitoring panel and viewable during operation.
 - 1) Engine lubricating-oil pressure gage.
 - 2) Engine-coolant temperature gage.
 - 3) DC voltmeter (alternator battery charging).
 - 4) Running-time meter.
 - 5) AC voltmeter, for each phase.
 - 6) AC ammeter, for each phase.
 - 7) AC frequency meter.
 - 8) Generator-voltage adjusting rheostat.
 - iv Controls and Protective Devices: Controls, shutdown devices, and common alarm indication, including the following:
 - 1) Cranking control equipment.
 - 2) Run-Off-Auto switch.
 - 3) Control switch not in automatic position alarm.

- 4) Overcrank alarm.
- 5) Overcrank shutdown device.
- 6) Low-water temperature alarm.
- 7) High engine temperature prealarm.
- 8) High engine temperature.
- 9) High engine temperature shutdown device.
- 10) Overspeed alarm.
- 11) Overspeed shutdown device.
- 12) Low fuel main tank.
 - Low-fuel-level alarm shall be initiated when the level falls below that required for operation for duration required for the indicated EPSS class.
- 13) Coolant low-level alarm.
- 14) Coolant low-level shutdown device.
- 15) Coolant high-temperature prealarm.
- 16) Coolant high-temperature alarm.
- 17) Coolant low-temperature alarm.
- 18) Coolant high-temperature shutdown device.
- 19) EPS load indicator.
- 20) Battery high-voltage alarm.
- 21) Low cranking voltage alarm.
- 22) Battery-charger malfunction alarm.
- 23) Battery low-voltage alarm.
- 24) Lamp test.
- 25) Contacts for local and remote common alarm.
- 26) Low-starting air pressure alarm.
- 27) Low-starting hydraulic pressure alarm.
- 28) Remote manual stop shutdown device.
- 29) Air shutdown damper alarm when used.
- 30) Air shutdown damper shutdown device when used.
- 31) Generator overcurrent-protective-device not-closed alarm.
- 32) Hours of operation.
- 33) Engine generator metering, including voltage, current, hertz, kilowatt, kilovolt ampere, and power factor.

6. Engine Generator Metering: Comply with Section "Electricity Metering."

- a. Common Remote Panel with Common Audible Alarm: Include necessary contacts and terminals in control and monitoring panel. Remote panel shall be powered from the engine generator battery.
- b. Remote Alarm Annunciator: An LED indicator light labeled with proper alarm conditions shall identify each alarm event, and a common audible signal shall sound for each alarm condition. Silencing switch in face of panel shall silence signal without altering visual indication. Connect so that after an alarm is silenced, clearing of initiating condition will reactivate alarm

until silencing switch is reset. Cabinet and faceplate are surface- or flush-mounting type to suit mounting conditions indicated.

- i Overcrank alarm.
 - ii Low water-temperature alarm.
 - iii High engine temperature pre-alarm.
 - iv High engine temperature alarm.
 - v Low lube oil pressure alarm.
 - vi Overspeed alarm.
 - vii Low fuel main tank alarm.
 - viii Low coolant level alarm.
 - ix Low cranking voltage alarm.
 - x Contacts for local and remote common alarm.
 - xi Audible-alarm silencing switch.
 - xii Air shutdown damper when used.
 - xiii Run-Off-Auto switch.
 - xiv Control switch not in automatic position alarm.
 - xv Fuel tank derangement alarm.
 - xvi Fuel tank high-level shutdown of fuel supply alarm.
 - xvii Lamp test.
 - xviii Low-cranking voltage alarm.
 - xix Generator overcurrent-protective-device not-closed alarm.
- c. Supporting Items: Include sensors, transducers, terminals, relays, and other devices and include wiring required to support specified items. Locate sensors and other supporting items on engine or generator unless otherwise indicated.
- d. Remote Emergency-Stop Switch: Flush; wall mounted unless otherwise indicated; and labeled. Push button shall be protected from accidental operation.
7. Generator Overcurrent and Fault Protection
- a. Overcurrent protective devices shall be coordinated to optimize selective tripping when a short circuit occurs.
 - i Overcurrent protective devices for the entire EPSS shall be coordinated to optimize selective tripping when a short circuit occurs. Coordination of protective devices shall consider both utility and EPSS as the voltage source.
 - ii Overcurrent protective devices for the EPSS shall be accessible only to authorized personnel.
 - b. Generator Circuit Breaker: Molded-case, thermal-magnetic type; 100 percent rated; complying with UL 489.
 - i Tripping Characteristic: Designed specifically for generator protection.
 - ii Trip Rating: Matched to generator output rating.
 - iii Shunt Trip: Connected to trip breaker when engine generator is shut down by other protective devices.
 - iv Mounting: Adjacent to, or integrated with, control and monitoring panel.
 - c. Generator Circuit Breaker: Molded-case, electronic-trip type; 100 percent rated; complying with UL 489.

- i Tripping Characteristics: Adjustable long-time and short-time delay and instantaneous.
 - ii Trip Settings: Selected to coordinate with generator thermal damage curve.
 - iii Shunt Trip: Connected to trip breaker when engine generator is shut down by other protective devices.
 - iv Mounting: Adjacent to, or integrated with, control and monitoring panel.
 - d. Generator Disconnect Switch: Molded-case type; 100 percent rated.
 - i Trip Rating: Matched to generator output rating.
 - ii Shunt Trip: Connected to trip switch when signaled by generator protector or by other protective devices.
 - e. Generator Protector: Microprocessor-based unit shall continuously monitor current level in each phase of generator output, integrate generator heating effect over time, and predict when thermal damage of alternator will occur. When signaled by generator protector or other engine generator protective devices, a shunt-trip device in the generator disconnect switch shall open the switch to disconnect the generator from load circuits. Protector performs the following functions:
 - i Initiates a generator overload alarm when generator has operated at an overload equivalent to 110 percent of full-rated load for 60 seconds. Indication for this alarm is integrated with other engine generator malfunction alarms. Contacts shall be available for load shed functions.
 - ii Under single- or three-phase fault conditions, regulates generator to 300 percent of rated full-load current for up to 10 seconds.
 - iii As overcurrent heating effect on the generator approaches the thermal damage point of the unit, protector switches the excitation system off, opens the generator disconnect device, and shuts down the engine generator.
 - iv Senses clearing of a fault by other overcurrent devices and controls recovery of rated voltage to avoid overshoot.
 - f. Ground-Fault Indication: Comply with NFPA 70, "Emergency System" signals for ground fault.
 - i Indicate ground fault with other engine generator alarm indications.
 - ii Trip generator protective device on ground fault.
8. Generator, Exciter, and Voltage Regulator
- a. Comply with NEMA MG 1.
 - b. Drive: Generator shaft shall be directly connected to engine shaft. Exciter shall be rotated integrally with generator rotor.
 - c. Construction shall prevent mechanical, electrical, and thermal damage due to vibration, overspeed up to 125 percent of rating, and heat during operation at 110 percent of rated capacity.
 - d. Enclosure: Dripproof.
 - e. Instrument Transformers: Mounted within generator enclosure.
 - f. Voltage Regulator: Solid-state type, separate from exciter, providing performance as specified and as required by NFPA 110.
 - i Adjusting Rheostat on Control and Monitoring Panel: Provide plus or minus 5 percent adjustment of output-voltage operating band.
 - ii Maintain voltage within 30 percent on one step, full load.
 - iii Provide anti-hunt provision to stabilize voltage.
 - iv Maintain frequency within 10 percent and stabilize at rated frequency.

- g. Strip Heater: Thermostatically controlled unit arranged to maintain stator windings above dew point.
 - h. Windings: Two-thirds pitch stator winding and fully linked amortisseur winding.
 - i. Subtransient Reactance: 12 percent, maximum.
9. Vibration Isolation Devices
- a. Elastomeric Isolator Pads: Oil- and water-resistant elastomer or natural rubber, arranged in single or multiple layers, molded with a nonslip pattern and galvanized-steel baseplates of sufficient stiffness for uniform loading over pad area, and factory cut to sizes that match requirements of supported equipment.
 - i. Material: Standard neoprene Natural rubber Bridge-bearing neoprene, complying with AASHTO M 251 separated by steel shims.
 - ii. Shore A Scale Durometer Rating: 60.
 - iii. Number of Layers: Four.
 - iv. Minimum Deflection: **1 inch**.
 - b. Restrained Spring Isolators: Freestanding, steel, open-spring isolators with seismic restraint.
 - i. Housing: Steel with resilient vertical-limit stops to prevent spring extension due to wind loads or if weight is removed; factory-drilled baseplate bonded to 1/4-inch thick, elastomeric isolator pad attached to baseplate underside; and adjustable equipment-mounting and -leveling bolt that acts as blocking during installation.
 - ii. Outside Spring Diameter: Not less than 80 percent of compressed height of the spring at rated load.
 - iii. Minimum Additional Travel: 50 percent of required deflection at rated load.
 - iv. Lateral Stiffness: More than 80 percent of rated vertical stiffness.
 - v. Overload Capacity: Support 200 percent of rated load, fully compressed, without deformation or failure.
 - vi. Minimum Deflection: 1 inch.
 - c. Comply with requirements in Section "Hydronic Piping Specialties" for vibration isolation and flexible connector materials for steel piping.
 - d. Comply with requirements in Section "Metal Ducts" for vibration isolation and flexible connector materials for exhaust shroud and ductwork.
 - e. Vibration isolation devices shall not be used to accommodate misalignments or to make bends.
10. Source Quality Control
- a. Prototype Testing: Factory test engine generator using same engine model, constructed of identical or equivalent components and equipped with identical or equivalent accessories.
 - i. Tests: Comply with IEEE 115 and with NFPA 110, Level 1 Energy Converters.

C Construction

C.1 Installation

1. Interruption of Existing Electrical Service: Do not interrupt electrical service to facilities occupied by Owner or others unless permitted under the following conditions and then only after arranging to provide temporary electrical service according to requirements indicated:
 - a. Notify Owner no fewer than two working days in advance of proposed interruption of electrical service.
 - b. Do not proceed with interruption of electrical service without Owner's written permission.

2. Comply with NECA 1 and NECA 404.
3. Comply with packaged engine generator manufacturers' written installation and alignment instructions and with NFPA 110.
4. Equipment Mounting:
 - a. Install packaged engine generators on cast-in-place concrete equipment bases. Comply with requirements for equipment bases and foundations specified in Section "Cast-in-Place Concrete."
 - b. Coordinate size and location of concrete bases for packaged engine generators. Cast anchor-bolt inserts into bases. Concrete, reinforcement, and formwork requirements are specified with concrete.
 - c. Install packaged engine generator with elastomeric isolator pads restrained spring isolators having a minimum deflection of 1 inch on 5-inch high concrete base. Secure sets to anchor bolts installed in concrete bases.
 - d. Install packaged engine generator to provide access, without removing connections or accessories, for periodic maintenance.
 - e. Exhaust System: Install Schedule 40 black steel piping with welded joints and connect to engine muffler. Install thimble at wall. Piping shall be same diameter as muffler outlet.
 - i Piping materials and installation requirements are specified in Section "Hydronic Piping."
 - ii Install flexible connectors and steel piping materials according to requirements in Section "Hydronic Piping Specialties."
 - iii Insulate muffler/silencer and exhaust system components according to requirements in Section "HVAC Piping Insulation."
 - iv Install isolating thimbles where exhaust piping penetrates combustibles with a minimum of 9 inches of clearance from combustibles.
 - f. Drain Piping: Install condensate drain piping to muffler drain outlet with a shutoff valve, stainless-steel flexible connector, and Schedule 40 black steel pipe with welded joints.
 - i Piping materials and installation requirements are specified in Section "Hydronic Piping."
 - ii Drain piping valves, connectors, and installation requirements are specified in Section "Hydronic Piping Specialties."
 - g. Fuel Piping:
 - i Diesel storage tanks, tank accessories, piping, valves, and specialties for fuel systems are specified in Section "Facility Fuel-Oil Piping."
 - ii Copper and galvanized steel shall not be used in the fuel-oil piping system.
 - iii Install electrical devices furnished by equipment manufacturers but not specified to be factory mounted.
5. Connections
 - a. Piping installation requirements are specified in other Sections. Drawings indicate general arrangement of piping and specialties.
 - b. Connect fuel, cooling-system, and exhaust-system piping adjacent to packaged engine generator to allow space for service and maintenance.
 - c. Connect cooling-system water piping to engine generator and heat exchanger with flexible connectors.
 - d. Connect engine exhaust pipe to engine with flexible connector.
 - e. Connect fuel piping to engines with a gate valve and union and flexible connector.

- f. Ground equipment according to Section "Grounding and Bonding for Electrical Systems."
 - g. Connect wiring according to Section "Low-Voltage Electrical Power Conductors and Cables." Provide a minimum of one 90-degree bend in flexible conduit routed to the engine generator from a stationary element.
 - h. Balance single-phase loads to obtain a maximum of 10 percent unbalance between any two phases.
6. Identification
- a. Identify system components according to Section "Identification for HVAC Piping and Equipment" and Section "Identification for Electrical Systems."
 - b. Install a sign indicating the generator neutral is bonded to the main service neutral at the main service location.
7. Field Quality Control
- a. Testing Agency: Owner will engage a qualified testing agency to perform tests and inspections.
 - b. Testing Agency: Engage a qualified testing agency to perform tests and inspections.
 - c. Manufacturer's Field Service: Engage a factory-authorized service representative to test and inspect components, assemblies, and equipment installations, including connections.
 - d. Perform tests and inspections with the assistance of a factory-authorized service representative.
 - e. Tests and Inspections:
 - i. Perform tests recommended by manufacturer and each visual and mechanical inspection and electrical and mechanical test listed in first two subparagraphs below, as specified in NETA ATS. Certify compliance with test parameters.
 - 1) Visual and Mechanical Inspection:
 - Compare equipment nameplate data with Drawings and the Specifications.
 - Inspect physical and mechanical condition.
 - Inspect anchorage, alignment, and grounding.
 - Verify that the unit is clean.
 - 2) Electrical and Mechanical Tests:
 - Perform insulation-resistance tests according to IEEE 43.
 - Machines Larger Than 200 hp: Test duration shall be 10 minutes. Calculate polarization index.
 - Machines 200 hp or Less: Test duration shall be one minute. Calculate the dielectric-absorption ratio.
 - Test protective relay devices.
 - Verify phase rotation, phasing, and synchronized operation as required by the application.
 - Functionally test engine shutdown for low oil pressure, overtemperature, overspeed, and other protection features as applicable.
 - Perform vibration test for each main bearing cap.
 - Verify correct functioning of the governor and regulator.
 - ii. NFPA 110 Acceptance Tests: Perform tests required by NFPA 110 that are additional to those specified here, including, but not limited to, single-step full-load pickup test.

- iii Battery Tests: Equalize charging of battery cells according to manufacturer's written instructions. Record individual cell voltages.
 - 1) Measure charging voltage and voltages between available battery terminals for full-charging and float-charging conditions. Check electrolyte level and specific gravity under both conditions.
 - 2) Test for contact integrity of all connectors. Perform an integrity load test and a capacity load test for the battery.
 - 3) Verify acceptance of charge for each element of the battery after discharge.
 - 4) Verify that measurements are within manufacturer's specifications.
 - iv Battery-Charger Tests: Verify specified rates of charge for both equalizing and float-charging conditions.
 - v System Integrity Tests: Methodically verify proper installation, connection, and integrity of each element of engine generator system before and during system operation. Check for air, exhaust, and fluid leaks.
 - vi Exhaust-System Back-Pressure Test: Use a manometer with a scale exceeding 40-inch wg. Connect to exhaust line close to engine exhaust manifold. Verify that back pressure at full-rated load is within manufacturer's written allowable limits for the engine.
 - vii Exhaust Emissions Test: Comply with applicable government test criteria.
 - viii Voltage and Frequency Transient Stability Tests: Use recording oscilloscope to measure voltage and frequency transients for 50 and 100 percent step-load increases and decreases, and verify that performance is as specified.
 - ix Harmonic-Content Tests: Measure harmonic content of output voltage at 25 and 100 percent of rated linear load. Verify that harmonic content is within specified limits.
 - x Noise Level Tests: Measure A-weighted level of noise emanating from engine generator installation, including engine exhaust and cooling-air intake and discharge, at four locations 25 feet from edge of the generator enclosure, and compare measured levels with required values.
- f. Coordinate tests with tests for transfer switches and run them concurrently.
 - g. Test instruments shall have been calibrated within the past 12 months, traceable to NIST Calibration Services, and adequate for making positive observation of test results. Make calibration records available for examination on request.
 - h. Leak Test: After installation, charge exhaust, coolant, and fuel systems and test for leaks. Repair leaks and retest until no leaks exist.
 - i. Operational Test: After electrical circuitry has been energized, start units to confirm proper motor rotation and unit operation for generator and associated equipment.
 - j. Test and adjust controls and safeties. Replace damaged and malfunctioning controls and equipment.
 - k. Remove and replace malfunctioning units and retest as specified above.
 - l. Retest: Correct deficiencies identified by tests and observations, and retest until specified requirements are met.
 - m. Report results of tests and inspections in writing. Record adjustable relay settings and measured insulation resistances, time delays, and other values and observations. Attach a label or tag to each tested component indicating satisfactory completion of tests.
8. Demonstration
- a. Engage a factory-authorized service representative to train Owner's maintenance personnel to adjust, operate, and maintain packaged engine generators.

D Measurement

The department will measure Diesel-Engine-Driven Generator Sets as an individual assembly acceptably completed.

E Payment

The department will pay for measured quantities at the contract unit price under the following bid item:

ITEM NUMBER	DESCRIPTION	UNIT
SPV.0060.01	Diesel-Engine-Driven Generator Sets	EACH

Payment is full compensation for furnishing and installing the generators and all set-up and testing required. The concrete support pad will be paid under the bid item for "Concrete Sidewalk 5-Inch."

**25. Canopy Column Anchor Rod Assemblies, Item SPV.0060.02;
Tower Column Anchor Rod Assemblies, Item SPV.0060.03.**

A Description

This special provision describes furnishing and installing anchor rod assemblies for the tower columns and canopy columns conforming to standard spec 531, except as noted below.

B Materials

Furnish steel anchor rod assemblies conforming to the following:

- Anchor Rods..... ASTM F1554, grade 55, supplementary specification S4
- Heavy Hex Nuts..... ASTM A563 grade DH or ASTM A194 grade 2H
- Washers..... ASTM F436
- Templates.....ASTM A36

Galvanizing 1 according to ASTM A153, class C and as follows:

- Hot-dipped..... ASTM F2329
- Mechanical.....ASTM B695,

Class 55 1 Use either hot-dipped or mechanical, but use the same process for all parts of the assembly.

Furnish galvanized anchor rods with a rolled thread on the top and bottom 12 inches. Ensure that nuts run freely on the rods after coating the threads and nuts with a wax-based lubricant. Submit a certified report of test or analysis to the engineer for the anchor rods, nuts, and washers. Do not install until the engineer approves the material.

C Construction

Secure steel reinforcement and anchor rod assemblies in place before placing concrete. Ensure that anchor rod assemblies remain secured in their specified location until the concrete hardens. Do not weld anchor rods. Protect anchor rod threads above the top of the foundation level from concrete splash.

Remove and replace the foundation concrete and anchor rod assembly under one or more of the following:

- Twisting, racking, or other movement of the anchor rods.
- Anchor rods are out of plumb, projection, or pattern.
- Anchor rod threads are damaged.

D Measurement

The department will measure Canopy Column Anchor Rod Assemblies and Tower Column Anchor Rod Assemblies as each individual assembly, acceptably completed.

E Payment

The department will pay for measured quantities at the contract unit price under the following bid item:

ITEM NUMBER	DESCRIPTION	UNIT
SPV.0060.02	Canopy Column Anchor Rod Assemblies	EACH
SPV.0060.03	Tower Column Anchor Rod Assemblies	EACH

Payment is full compensation for furnishing the anchor rods, nuts, washers, and templates for each anchor assembly, galvanizing, and installation of the anchor assemblies.

26. Switchboards, Item SPV.0060.04.

A Description

This special provision describes furnishing materials necessary for the installation, testing, and making fully operational the electrical switchboards. All additional special provisions provide further information, requirements, and guidelines that are applicable to the work paid for under the bid items addressed by this special provision.

Comply with all local codes, all laws applying to electrical installations in effect, the regulations of the latest National Electrical Code, where such regulations do not conflict with the laws in effect and with the requirements of the utility company.

It is the intention of the contract plans to call for completely finished work, fully tested and ready for reliable and consistent operation. Furnish, deliver, and install any apparatus, appliance, materials, or work not shown on the plans but mentioned in the special provisions or vice versa, or any incidental accessories necessary to make the work complete in all respects and ready for operation, to be furnished, delivered, and installed without additional expense to the department.

B Materials

B.1 General

Section Includes:

1. Service and distribution switchboards rated 600 V and less.
2. Surge protection devices.
3. Disconnecting and overcurrent protective devices.
4. Instrumentation.
5. Control power.
6. Accessory components and features.
7. Identification.

B.2 Action Submittals

1. Product Data: For each switchboard, overcurrent protective device, surge protection device, ground-fault protector, accessory, and component.
2. Shop Drawings: For each switchboard and related equipment.
3. Include dimensioned plans, elevations, sections, and details, including required clearances and service space around equipment. Show tabulations of installed devices, equipment features, and ratings.

4. Detail enclosure types for types other than NEMA 250, Type 1.
5. Detail bus configuration, current, and voltage ratings.
6. Detail short-circuit current rating of switchboards and overcurrent protective devices.
7. Detail utility company's metering provisions with indication of approval by utility company.
8. Include evidence of NRTL listing for series rating of installed devices.
9. Detail features, characteristics, ratings, and factory settings of individual overcurrent protective devices and auxiliary components.
10. Include time-current coordination curves for each type and rating of overcurrent protective device included in switchboards. Submit on translucent log-log graft paper; include selectable ranges for each type of overcurrent protective device.
11. Include schematic and wiring diagrams for power, signal, and control wiring.

B.3 Informational Submittals

1. Qualification Data: For testing agency.
2. Seismic Qualification Certificates: For switchboards, overcurrent protective devices, accessories, and components, from manufacturer.
 - a. Basis for Certification: Indicate whether withstand certification is based on actual test of assembled components or on calculation.
 - b. Dimensioned Outline Drawings of Equipment Unit: Identify center of gravity and locate and describe mounting and anchorage provisions.
 - c. Detailed description of equipment anchorage devices on which the certification is based and their installation requirements.
3. Field quality-control reports.

B.4 Closeout Submittals

1. Operation and maintenance data.

B.5 Quality Assurance

1. Installer Qualifications: An employer of workers qualified as defined in NEMA PB 2.1 and trained in electrical safety as required by NFPA 70E.
2. Testing Agency Qualifications: Member company of NETA or an NRTL.

B.6 Field Conditions

1. Installation Pathway: Remove and replace access fencing, doors, lift-out panels, and structures to provide pathway for moving switchboards into place.
2. Environmental Limitations:
 - a. Do not deliver or install switchboards until spaces are enclosed and weathertight, wet work in spaces is complete and dry, work above switchboards is complete, and HVAC system is operating and maintaining ambient temperature and humidity conditions at occupancy levels during the remainder of the construction period.
 - b. Rate equipment for continuous operation under the following conditions unless otherwise indicated:
 - c. Ambient Temperature: Not exceeding 104 deg F.
 - d. Altitude: Not exceeding 6600 feet.

B.7 Warranty

1. Manufacturer's Warranty: Manufacturer agrees to repair or replace switchboard enclosures, buswork, overcurrent protective devices, accessories, and factory installed interconnection wiring that fail in materials or workmanship within specified warranty period.
 - a. Warranty Period: Three years from date of Substantial Completion.
2. Manufacturer's Warranty: Manufacturer's agrees to repair or replace surge protection devices that fail in materials or workmanship within specified warranty period.
 - a. Warranty Period: Five years from date of Substantial Completion.

B.8 Performance Requirements

1. Seismic Performance: Switchboards shall withstand the effects of earthquake motions determined according to ASCE/SEI 7.
 - a. Basis for Certification: Indicate whether withstand certification is based on actual test of assembled components or on calculation. Shake-table testing shall comply with ICC-ES AC156.
 - b. The term "withstand" means "the unit will remain in place without separation of any parts from the device when subjected to the seismic forces specified."

B.9 Switchboards

1. Square D, Eaton or approved equal.
2. Source Limitations: Obtain switchboards, overcurrent protective devices, components, and accessories from single source from single manufacturer.
3. Product Selection for Restricted Space: Drawings indicate maximum dimensions for switchboards including clearances between switchboards and adjacent surfaces and other items. Comply with indicated maximum dimensions.
4. Comply with NEMA PB 2.
5. Comply with NFPA 70.
6. Comply with UL 891.
7. Front-Connected, Front-Accessible Switchboards:
 - a. Main Devices: Panel mounted.
 - b. Branch Devices: Panel mounted.
 - c. Sections front and rear aligned.
8. Nominal System Voltage: 480Y/277 V.
9. Main-Bus Continuous: 1200 A.
10. Seismic Requirements: Fabricate and test switchboards according to IEEE 344 to withstand seismic forces defined in Section "Seismic Controls for Electrical Systems."
 - a. Basis for Certification: Indicate whether withstand certification is based on actual test of assembled components or on calculation. Shake-table testing shall comply with ICC-ES AC156.
11. The term "withstand" means "the unit will remain in place without separation of any parts from the device when subjected to the seismic forces specified."
12. The term "withstand" means "the unit will remain in place without separation of any parts from the device when subjected to the seismic forces specified and the unit will be fully operational after the seismic event."
13. Indoor Enclosures: Steel, NEMA 250, Type 1.

14. Space Heaters: Factory-installed electric space heaters of sufficient wattage in each vertical section to maintain enclosure temperature above expected dew point.
 - a. Space-Heater Control: Thermostats to maintain temperature of each section above expected dew point.
 - b. Space-Heater Power Source: Transformer, factory installed in switchboard.
15. Service Entrance Rating: Switchboards intended for use as service entrance equipment shall contain from one to six service disconnecting means with overcurrent protection, a neutral bus with disconnecting link, a grounding electrode conductor terminal, and a main bonding jumper.
16. Bus Transition and Incoming Pull Sections: Matched and aligned with basic switchboard.
17. Hinged Front Panels: Allow access to circuit breaker, metering, accessory, and blank compartments.
18. Pull Box on Top of Switchboard:
 - a. Adequate ventilation to maintain temperature in pull box within same limits as switchboard.
 - b. Set back from front to clear circuit-breaker removal mechanism.
 - c. Removable covers shall form top, front, and sides. Top covers at rear shall be easily removable for drilling and cutting.
 - d. Bottom shall be insulating, fire-resistive material with separate holes for cable drops into switchboard.
 - e. Cable supports shall be arranged to facilitate cabling and adequate to support cables indicated, including those for future installation.
 - f. Buses and Connections: Three phase, four wire unless otherwise indicated.
 - g. Provide phase bus arrangement A, B, C from front to back, top to bottom, and left to right when viewed from the front of the switchboard.
 - h. Phase- and Neutral-Bus Material: copper
 - i. Load Terminals: Insulated, rigidly braced, runback bus extensions, of same material as through buses, equipped with mechanical connectors for outgoing circuit conductors. Provide load terminals for future circuit-breaker positions at full-ampere rating of circuit-breaker position.
 - j. Ground Bus: Minimum-size required by UL 891, hard-drawn copper of 98 percent conductivity, equipped with mechanical connectors for feeder and branch-circuit ground conductors.
 - k. Main-Phase Buses and Equipment-Ground Buses: Uniform capacity for entire length of switchboard's main and distribution sections. Provide for future extensions from both ends.
19. Disconnect Links:
 - a. Isolate neutral bus from incoming neutral conductors.
 - b. Bond neutral bus to equipment-ground bus for switchboards utilized as service equipment or separately derived systems.
 - c. Neutral Buses: 100 percent of the ampacity of phase buses unless otherwise indicated, equipped with mechanical connectors for outgoing circuit neutral cables. Brace bus extensions for busway feeder neutral bus.
 - d. Future Devices: Equip compartments with mounting brackets, supports, bus connections, and appurtenances at full rating of circuit-breaker compartment.

B.10 Surge Protection Devices

1. SPDs: Listed and labeled by an NRTL acceptable to authorities having jurisdiction as complying with UL 1449, Type 1.

2. SPDs with the following features and accessories:
 - a. Integral disconnect switch.
 - b. Internal thermal protection that disconnects the SPD before damaging internal suppressor components.
 - c. Indicator light display for protection status.
 - i Form-C contacts. One normally open and one normally closed, for remote monitoring of protection status.
 - ii Surge counter.
 - d. Peak Surge Current Rating: The minimum single-pulse surge current withstand rating per phase shall not be less than 200 kA. The peak surge current rating shall be the arithmetic sum of the ratings of the individual MOVs in a given mode.
 - e. Protection modes and UL 1449 VPR for grounded wye circuits with 480Y/277 V, three-phase, four-wire circuits shall not exceed the following:
 - i Line to Neutral: 1200 V for 480Y/277 V.
 - ii Line to Ground: 1200 V for 480Y/277 V.
 - iii Line to Line: 2000 V for 480Y/277 V
 - f. SCCR: Per drawings.

B.11 Disconnecting and Overcurrent Protective Devices

1. Comply with NEC 240.87 for overcurrent devices 1200 A or higher. Provide method to reduce clearing time for arc energy reduction that complies with NEC 240.87(B).
2. Molded-Case Circuit Breaker (MCCB): Comply with UL 489, with interrupting capacity to meet available fault currents.
3. Thermal-Magnetic Circuit Breakers: Inverse time-current element for low-level overloads and instantaneous magnetic trip element for short circuits. Adjustable magnetic trip setting for circuit-breaker frame sizes 250 A and larger.
4. Adjustable Instantaneous-Trip Circuit Breakers: Magnetic trip element with front-mounted, field-adjustable trip setting.
5. Electronic trip circuit breakers with rms sensing; field-replaceable rating plug or field-replaceable electronic trip; and the following field-adjustable settings:
 - a. Instantaneous trip.
 - b. Long- and short-time pickup levels.
 - c. Long and short time adjustments.
 - d. Ground-fault pickup level, time delay, and I^2t response.
6. Current-Limiting Circuit Breakers: Frame sizes 400 A and smaller; let-through ratings less than NEMA FU 1, RK-5.
7. Integrally Fused Circuit Breakers: Thermal-magnetic trip element with integral limiter-style fuse listed for use with circuit breaker; trip activation on fuse opening or on opening of fuse compartment door.
8. GFCI Circuit Breakers: Single- and double-pole configurations with Class A ground-fault protection (6-mA trip).
9. Ground-Fault Equipment Protection (GFEP) Circuit Breakers: Class B ground-fault protection (30-mA trip).

10. MCCB Features and Accessories:
 - a. Standard frame sizes, trip ratings, and number of poles.
 - b. Lugs: Mechanical style, suitable for number, size, trip ratings, and conductor material.
 - c. Application Listing: Appropriate for application; Type SWD for switching fluorescent lighting loads; Type HID for feeding fluorescent and high-intensity discharge (HID) lighting circuits.
 - d. Ground-Fault Protection: Integrally mounted relay and trip unit with adjustable pickup and time-delay settings, push-to-test feature, and ground-fault indicator.
 - e. Zone-Selective Interlocking: Integral with electronic trip unit; for interlocking ground-fault protection function.
 - f. Communication Capability: Universal-mounted communication module with functions and features compatible with power monitoring and control system specified in Section "Electrical Power Monitoring and Control."
 - g. Shunt Trip: 120-V trip coil energized from separate circuit.
 - h. Undervoltage Trip: Set to operate at 35 to 75 percent of rated voltage without intentional time delay.
 - i. Auxiliary Contacts: Two SPDT switches with "a" and "b" contacts; "a" contacts mimic circuit-breaker contacts, "b" contacts operate in reverse of circuit-breaker contacts.
 - j. Key Interlock Kit: Externally mounted to prohibit circuit-breaker operation; key shall be removable only when circuit breaker is in off position.
11. Insulated-Case Circuit Breaker (ICCB): 80 percent rated, sealed, insulated-case power circuit breaker with interrupting capacity rating to meet available fault current.
12. Fixed circuit-breaker mounting.
13. Two-step, stored-energy closing.
14. Standard-function, microprocessor-based trip units with interchangeable rating plug, trip indicators, and the following field-adjustable settings:
15. Instantaneous trip.
16. Time adjustments for long- and short-time pickup.
17. Ground-fault pickup level, time delay, and I²t response.
18. Zone-Selective Interlocking: Integral with electronic trip unit; for interlocking ground-fault protection function.
19. Remote trip indication and control.
20. Communication Capability: Web enabled integral Ethernet communication module and embedded Web server with factory-configured Web pages (HTML file format). Provide functions and features compatible with power monitoring and control system specified in Section 260913 "Electrical Power Monitoring and Control."
21. Key Interlock Kit: Externally mounted to prohibit circuit-breaker operation; key shall be removable only when circuit breaker is in off position.
22. Bolted-Pressure Contact Switch: Operating mechanism uses rotary-mechanical-bolting action to produce and maintain high clamping pressure on the switch blade after it engages the stationary contacts.
23. Main-Contact Interrupting Capability: Minimum of 12 times the switch current rating.

24. Operating Mechanism: Manual handle operation to close switch; stores energy in mechanism for opening and closing.
 - a. Electrical Trip: Operation of lever or push-button trip switch, or trip signal from ground-fault relay or remote-control device, causes switch to open.
 - b. Mechanical Trip: Operation of mechanical lever, push button, or other device causes switch to open.
25. Auxiliary Switches: Factory installed, SPDT, with leads connected to terminal block, and including one set more than quantity required for functional performance indicated.
26. Service-Rated Switches: Labeled for use as service equipment.
27. Ground-Fault Relay: Comply with UL 1053; self-powered type with mechanical ground-fault indicator, test function, tripping relay with internal memory, and three-phase current transformer/sensor.
28. Configuration: Integrally mounted relay and trip unit with adjustable pickup and time-delay settings, push-to-test feature, and ground-fault indicator.
29. Open-Fuse Trip Device: Arranged to trip switch open if a phase fuse opens.
30. High-Pressure, Butt-Type Contact Switch: Operating mechanism uses butt-type contacts and a spring-charged mechanism to produce and maintain high-pressure contact when switch is closed.
31. Main-Contact Interrupting Capability: Minimum of 12 times the switch current rating.
32. Operating Mechanism: Manual handle operation to close switch; stores energy in mechanism for opening and closing.
 - a. Electrical Trip: Operation of lever or push-button trip switch, or trip signal from ground-fault relay or remote-control device, causes switch to open.
33. Mechanical Trip: Operation of mechanical lever, push button, or other device causes switch to open.
34. Auxiliary Switches: Factory installed, SPDT, with leads connected to terminal block, and including one set more than quantity required for functional performance indicated.
35. Service-Rated Switches: Labeled for use as service equipment.
36. Ground-Fault Relay: Comply with UL 1053; self-powered type with mechanical ground-fault indicator, test function, tripping relay with internal memory, and three-phase current transformer/sensor.
 - a. Configuration: Integrally mounted relay and trip unit with adjustable pickup and time-delay settings, push-to-test feature, and ground-fault indicator.
37. Open-Fuse Trip Device: Arranged to trip switch open if a phase fuse opens.
 - a. Fused Switch: NEMA KS 1, Type HD; clips to accommodate specified fuses; lockable handle.
 - b. Fuses are specified in Section "Fuses."

B.12 Instrumentation

B.12.1 Instrument Transformers:

NEMA EI 21.1, and the following:

1. Potential Transformers: NEMA EI 21.1; 120 V, 60 Hz, single secondary; disconnecting type with integral fuse mountings. Burden and accuracy shall be consistent with connected metering and relay devices.
2. Current Transformers: NEMA EI 21.1; 5 A, 60 Hz, secondary; wound type; single secondary winding and secondary shorting device. Burden and accuracy shall be consistent with connected metering and relay devices.
3. Control-Power Transformers: Dry type, mounted in separate compartments for units larger than 3 kVA.

4. Current Transformers for Neutral and Ground-Fault Current Sensing: Connect secondary wiring to ground overcurrent relays, via shorting terminals, to provide selective tripping of main and tie circuit breaker. Coordinate with feeder circuit-breaker, ground-fault protection.

B.12.2 Multifunction Digital-Metering Monitor:

Microprocessor-based unit suitable for three- or four-wire systems and with the following features:

1. Switch-selectable digital display of the following values with maximum accuracy tolerances as indicated:
 - a. Phase Currents, Each Phase: Plus or minus 0.5 percent.
 - b. Phase-to-Phase Voltages, Three Phase: Plus or minus 0.5 percent.
 - c. Phase-to-Neutral Voltages, Three Phase: Plus or minus 0.5 percent.
 - d. Megawatts: Plus or minus 1 percent.
 - e. Megavars: Plus or minus 1 percent.
 - f. Power Factor: Plus or minus 1 percent.
 - g. Frequency: Plus or minus 0.1 percent.
 - h. Accumulated Energy, Megawatt Hours: Plus or minus 1 percent; accumulated values unaffected by power outages up to 72 hours.
 - i. Megawatt Demand: Plus or minus 1 percent; demand interval programmable from five to 60 minutes.
 - j. Contact devices to operate remote impulse-totalizing demand meter.
2. Mounting: Display and control unit flush or semiflush mounted in instrument compartment door.
3. Watt-Hour Meters and Wattmeters:
 - a. Comply with ANSI C12.1.
 - b. Three-phase induction type with two stators, each with current and potential coil, rated 5 A, 120 V, 60 Hz.
 - c. Suitable for connection to three- and four-wire circuits.
 - d. Potential indicating lamps.
 - e. Adjustments for light and full load, phase balance, and power factor.
 - f. Four-dial clock register.
 - g. Ratchets to prevent reverse rotation.
 - h. Removable meter with drawout test plug.
 - i. Semiflush mounted case with matching cover.
 - j. Appropriate multiplier tag.
4. Impulse-Totalizing Demand Meter:
 - a. Comply with ANSI C12.1.
 - b. Suitable for use with switchboard watt-hour meter, including two-circuit totalizing relay.
 - c. Cyclometer.
 - d. Four-dial, totalizing kilowatt-hour register.
 - e. Positive chart drive mechanism.
 - f. Capillary pen holding a minimum of one month's ink supply.
 - g. Roll chart with minimum 31-day capacity; appropriate multiplier tag.
 - h. Capable of indicating and recording five-minute integrated demand of totalized system.

5. Control Power
 - a. Control Circuits: 120-V ac, supplied through secondary disconnecting devices from control-power transformer.
 - b. Electrically Interlocked Main and Tie Circuit Breakers: Two control-power transformers in separate compartments, with interlocking relays, connected to the primary side of each control-power transformer at the line side of the associated main circuit breaker. 120-V secondaries connected through automatic transfer relays to ensure a fail-safe automatic transfer scheme.
 - c. Control-Power Fuses: Primary and secondary fuses for current-limiting and overload protection of transformer and fuses for protection of control circuits.
 - d. Control Wiring: Factory installed, with bundling, lacing, and protection included. Provide flexible conductors for No. 8 AWG and smaller, for conductors across hinges, and for conductors for interconnections between shipping units.
6. Accessory Components and Features
 - a. Portable Test Set: For testing functions of solid-state trip devices without removing from switchboard. Include relay and meter test plugs suitable for testing switchboard meters and switchboard class relays.
 - b. Spare-Fuse Cabinet: Suitably identified, wall-mounted, lockable, compartmented steel box or cabinet. Arrange for wall mounting.
 - c. Mounting Accessories: For anchors, mounting channels, bolts, washers, and other mounting accessories, comply with requirements in "Seismic Controls for Electrical Systems" or manufacturer's instructions.

B.12.3 Identification

1. Service Equipment Label: NRTL labeled for use as service equipment for switchboards with one or more service disconnecting and overcurrent protective devices.

C Construction

C.1 Installation

1. Receive, inspect, handle, and store switchboards according to NECA 400.
2. Install switchboards and accessories according to NECA 400.
3. Equipment Mounting: Install switchboards on concrete base, 4-inch nominal thickness. Comply with requirements for concrete base specified in Section "Cast-in-Place Concrete."
 - a. Install conduits entering underneath the switchboard, entering under the vertical section where the conductors will terminate. Install with couplings flush with the concrete base. Extend 2 inches above concrete base after switchboard is anchored in place.
 - b. Install dowel rods to connect concrete base to concrete floor. Unless otherwise indicated, install dowel rods on 18-inch centers around the full perimeter of concrete base.
 - c. For supported equipment, install epoxy-coated anchor bolts that extend through concrete base and anchor into structural concrete floor.
 - d. Place and secure anchorage devices. Use setting drawings, templates, diagrams, instructions, and directions furnished with items to be embedded.
 - e. Install anchor bolts to elevations required for proper attachment to switchboards.
 - f. Anchor switchboard to building structure at the top of the switchboard if required or recommended by the manufacturer.
4. Temporary Lifting Provisions: Remove temporary lifting eyes, channels, straps and brackets, and temporary blocking of moving parts from switchboard units and components.

5. Comply with mounting and anchoring requirements specified in Section "Seismic Controls for Electrical Systems."
6. Operating Instructions: Frame and mount the printed basic operating instructions for switchboards, including control and key interlocking sequences and emergency procedures. Fabricate frame of finished wood or metal and cover instructions with clear acrylic plastic. Mount on front of switchboards.
7. Install filler plates in unused spaces of panel-mounted sections.
8. Install overcurrent protective devices, surge protection devices, and instrumentation.
9. Set field-adjustable switches and circuit-breaker trip ranges.
10. Install spare-fuse cabinet.
11. Comply with NECA 1.
12. Comply with requirements for terminating feeder bus specified in Section "Enclosed Bus Assemblies." Drawings indicate general arrangement of bus, fittings, and specialties.
13. Comply with requirements for terminating cable trays specified in Section "Cable Trays for Electrical Systems." Drawings indicate general arrangement of cable trays, fittings, and specialties.

C.2 Identification

1. Identify field-installed conductors, interconnecting wiring, and components; provide warning signs complying with requirements for identification specified in Section "Identification for Electrical Systems."
2. Switchboard Nameplates: Label each switchboard compartment with a nameplate complying with requirements for identification specified in Section "Identification for Electrical Systems."
3. Device Nameplates: Label each disconnecting and overcurrent protective device and each meter and control device mounted in compartment doors with a nameplate complying with requirements for identification specified in Section "Identification for Electrical Systems."

C.3 Field Quality Control

1. Perform the following tests and inspections:
2. Acceptance Testing:
 - a. Test insulation resistance for each switchboard bus, component, connecting supply, feeder, and control circuit. Open control and metering circuits within the switchboard, and remove neutral connection to surge protection and other electronic devices prior to insulation test. Reconnect after test.
 - b. Test continuity of each circuit.
3. Test ground-fault protection of equipment for service equipment per NFPA 70.
4. Perform each visual and mechanical inspection and electrical test stated in NETA Acceptance Testing Specification. Certify compliance with test parameters.
5. Correct malfunctioning units on-site where possible, and retest to demonstrate compliance; otherwise, replace with new units and retest.
6. Test and adjust controls, remote monitoring, and safeties. Replace damaged and malfunctioning controls and equipment.
7. Switchboard will be considered defective if it does not pass tests and inspections.
8. Prepare test and inspection reports, including a certified report that identifies switchboards included and that describes scanning results. Include notation of deficiencies detected, remedial action taken, and observations after remedial action.

C.4 Demonstration

1. Train Owner's maintenance personnel to adjust, operate, and maintain switchboards, overcurrent protective devices, instrumentation, and accessories.

D Measurement

The department will measure Switchboards as each individual assembly, acceptably completed.

E Payment

The department will pay for measured quantities at the contract unit price under the following bid item:

ITEM NUMBER	DESCRIPTION	UNIT
SPV.0060.04	Switchboards	EACH

Payment is full compensation for furnishing and installing the switchboards, including all material and labor.

27. Transfer Switches, Item SPV.0060.05.

A Description

This special provision describes furnishing materials necessary for the installation, testing, and making fully operational the transfer switch. All additional special provisions provide further information, requirements, and guidelines that are applicable to the work paid for under the bid items addressed by this special provision.

Comply with all local codes, all laws applying to electrical installations in effect, the regulations of the latest National Electrical Code, where such regulations do not conflict with the laws in effect and with the requirements of the utility company.

It is the intention of the contract plans to call for completely finished work, fully tested and ready for reliable and consistent operation. Furnish, deliver, and install any apparatus, appliance, materials, or work not shown on the plans but mentioned in the special provisions or vice versa, or any incidental accessories necessary to make the work complete in all respects and ready for operation, to be furnished, delivered, and installed without additional expense to the department.

B Materials

Section includes automatic transfer switches rated 600 V and less.

B.1 Action Submittals

1. Product Data: For each type of product.
2. Shop Drawings:
 - a. Include plans, elevations, sections, details showing minimum clearances, conductor entry provisions, gutter space, and installed features and devices.
 - b. Single-Line Diagram: Show connections between transfer switch, power sources, and load.

B.2 Informational Submittals

1. Seismic Qualification Certificates: For transfer switches, accessories, and components, from manufacturer.
2. Source quality control reports.
3. Field quality-control reports.

B.3 Closeout Submittals

1. Operation and maintenance data.

B.4 Warranty

1. Manufacturer's Warranty: Manufacturer agrees to repair or replace components of transfer switch or transfer switch components that fail in materials or workmanship within specified warranty period.
2. Warranty Period: 12 months from date of Substantial Completion.

B.5 Products

1. Performance Requirements
 - a. Electrical Components, Devices, and Accessories: Listed and labeled as defined in NFPA 70, by a qualified testing agency, and marked for intended location and application.
 - b. Comply with NEMA ICS 1.
 - c. Comply with NFPA 99.
 - d. Comply with NFPA 110.
 - e. Comply with UL 1008 unless requirements of these Specifications are stricter.
 - f. Indicated Current Ratings: Apply as defined in UL 1008 for continuous loading and total system transfer, including tungsten filament lamp loads not exceeding 30 percent of switch ampere rating, unless otherwise indicated.
 - g. Tested Fault-Current Closing and Short-Circuit Ratings: Adequate for duty imposed by protective devices at installation locations in Project under the fault conditions indicated, based on testing according to UL 1008.
 - h. Where transfer switch includes internal fault-current protection, rating of switch and trip unit combination shall exceed indicated fault-current value at installation location.
 - i. Repetitive Accuracy of Solid-State Controls: All settings shall be plus or minus 2 percent or better over an operating temperature range of minus 20 to plus 70 deg C.
 - j. Resistance to Damage by Voltage Transients: Components shall meet or exceed voltage-surge withstand capability requirements when tested according to IEEE C62.62. Components shall meet or exceed voltage-impulse withstand test of NEMA ICS 1.
 - k. Electrical Operation: Accomplish by a nonfused, momentarily energized solenoid or electric-motor-operated mechanism. Switches for emergency or standby purposes shall be mechanically and electrically interlocked in both directions to prevent simultaneous connection to both power sources unless closed transition.
 - l. Service-Rated Transfer Switch:
 - i Comply with UL 869A and UL 489.
 - ii Provide terminals for bonding the grounding electrode conductor to the grounded service conductor.
 - iii In systems with a neutral, the bonding connection shall be on the neutral bus.
 - iv Provide removable link for temporary separation of the service and load grounded conductors.
 - v Surge Protective Device: Service rated.
 - vi Ground-Fault Protection: Comply with UL 1008 for normal and alternative buses.
 - vii Service Disconnecting Means: Externally operated, manual mechanically actuated.
 - m. Neutral Switching: Where four-pole switches are indicated, provide neutral pole switched simultaneously with phase poles.
 - n. Neutral Terminal: Solid and fully rated unless otherwise indicated.

- o. Battery Charger: For generator starting batteries.
 - i. Float type.
 - ii. Ammeter to display charging current.
 - iii. Fused ac inputs and dc outputs.
 - p. Factory Wiring: Train and bundle factory wiring and label, consistent with Shop Drawings, by color-code or by numbered or lettered wire and cable with printed markers at terminations. Color-coding and wire and cable markers are specified in Section "Identification for Electrical Systems."
 - i. Designated Terminals: Pressure type, suitable for types and sizes of field wiring indicated.
 - ii. Power-Terminal Arrangement and Field-Wiring Space: Suitable for top, side, or bottom entrance of feeder conductors as indicated.
 - iii. Control Wiring: Equipped with lugs suitable for connection to terminal strips.
 - iv. Accessible via front access.
2. Enclosures: General-purpose NEMA 250, Type 1, complying with NEMA ICS 6 and UL 508, unless otherwise indicated.

B.6 Molded-Case-Type Automatic Transfer Switches

1. Comply with Level 1 equipment according to NFPA 110.
2. Comply with NEC 240.87 for overcurrent devices 1200 A or higher. Provide method to reduce clearing time for arc energy reduction that complies with NEC 240.87(B).
3. Switch Characteristics: Designed for continuous-duty repetitive transfer of full-rated current between active power sources.
 - a. Limitation: Switches using contactor-based components are unacceptable.
 - b. Switch Action: Double throw; mechanically held in both directions.
 - c. Contacts: Silver composition or silver alloy for load-current switching.
 - d. Conductor Connectors: Suitable for use with conductor material and sizes.
 - e. Material: Hard-drawn copper, 98 percent conductivity.
 - f. Main and Neutral Lugs: Mechanical type.
 - g. Ground Lugs and Bus-Configured Terminators: Mechanical type.
 - h. Ground bar.
 - i. Connectors shall be marked for conductor size and type according to UL 1008.
 - j. Automatic Open-Transition Transfer Switches: Interlocked to prevent the load from being closed on both sources at the same time.
 - k. Sources shall be mechanically and electrically interlocked to prevent closing both sources on the load at the same time.
4. Automatic Delayed-Transition Transfer Switches: Pauses or stops in intermediate position to momentarily disconnect both sources, with transition controlled by programming in the automatic transfer-switch controller. Interlocked to prevent the load from being closed on both sources at the same time.
 - a. Adjustable Time Delay: For override of normal-source voltage sensing to delay transfer and engine start signals for alternative source. Adjustable from zero to six seconds, and factory set for one second.
 - b. Sources shall be mechanically and electrically interlocked to prevent closing both sources on the load at the same time.

- c. Fully automatic break-before-make operation with center off position.
 - d. Fully automatic break-before-make operation with transfer when two sources have near zero phase difference.
5. Signal-Before-Transfer Contacts: A set of normally open/normally closed dry contacts operates in advance of retransfer to normal source. Interval shall be adjustable from 1 to 30 seconds.
 6. Transfer Switches Based on Molded-Case-Switch Components: Comply with UL 489 and UL 869A.
 7. Automatic Transfer-Switch Controller Features:
 - a. Controller operates through a period of loss of control power.
 - b. Undervoltage Sensing for Each Phase of Normal and Alternative Source: Sense low phase-to-ground voltage on each phase. Pickup voltage shall be adjustable from 85 to 100 percent of nominal, and dropout voltage shall be adjustable from 75 to 98 percent of pickup value. Factory set for pickup at 90 percent and dropout at 85 percent.
 - c. Voltage/Frequency Lockout Relay: Prevent premature transfer to generator. Pickup voltage shall be adjustable from 85 to 100 percent of nominal. Factory set for pickup at 90 percent. Pickup frequency shall be adjustable from 90 to 100 percent of nominal. Factory set for pickup at 95 percent.
 - d. Time Delay for Retransfer to Normal Source: Adjustable from zero to 30 minutes, and factory set for 10 minutes. Override shall automatically defeat delay on loss of voltage or sustained undervoltage of emergency source, provided normal supply has been restored.
 - e. Test Switch: Simulate normal-source failure.
 - f. Switch-Position Pilot Lights: Indicate source to which load is connected.
 - g. Source-Available Indicating Lights: Supervise sources via transfer-switch normal- and emergency-source sensing circuits.
 - i. Normal Power Supervision: Green light with nameplate engraved "Normal Source Available."
 - ii. Emergency Power Supervision: Red light with nameplate engraved "Emergency Source Available."
 8. Unassigned Auxiliary Contacts: Two normally open, single-pole, double-throw contacts for each switch position, rated 10 A at 240-V ac.
 9. Transfer Override Switch: Overrides automatic retransfer control so automatic transfer switch will remain connected to emergency power source regardless of condition of normal source. Pilot light indicates override status.
 10. Engine Starting Contacts: One isolated and normally closed, and one isolated and normally open; rated 10 A at 32-V dc minimum.
 11. Engine Shutdown Contacts: Instantaneous; shall initiate shutdown sequence at remote engine-generator controls after retransfer of load to normal source.
 12. Engine Shutdown Contacts: Time delay adjustable from zero to five minutes, and factory set for five minutes. Contacts shall initiate shutdown at remote engine-generator controls after retransfer of load to normal source.
 13. Engine-Generator Exerciser: Solid-state, programmable-time switch starts engine generator and transfers load to it from normal source for a preset time, then retransfers and shuts down engine after a preset cool-down period. Initiates exercise cycle at preset intervals adjustable from 7 to 30 days. Running periods shall be adjustable from 10 to 30 minutes. Factory settings shall be for 7-day exercise cycle, 20-minute running period, and 5-minute cool-down period. Exerciser features include the following:
 - a. Exerciser Transfer Selector Switch: Permits selection of exercise with and without load transfer.

- b. Push-button programming control with digital display of settings.
 - i. Integral battery operation of time switch when normal control power is unavailable.

14. Large-Motor-Load Power Transfer:

- a. In-Phase Monitor: Factory-wired, internal relay controls transfer so contacts close only when the two sources are synchronized in phase and frequency. Relay shall compare phase relationship and frequency difference between normal and emergency sources and initiate transfer when both sources are within 15 electrical degrees, and only if transfer can be completed within 60 electrical degrees. Transfer shall be initiated only if both sources are within 2 Hz of nominal frequency and 70 percent or more of nominal voltage.
- b. Motor Disconnect and Timing Relay Controls: Designated starters in loss of power scenario shall disconnect motors before transfer and reconnect them selectively at an adjustable time interval after transfer. Control connection to motor starters shall be through wiring external to automatic transfer switch. Provide adjustable time delay between 1 and 60 seconds for reconnecting individual motor loads. Provide relay contacts rated for motor-control circuit inrush and for actual seal currents to be encountered.
- c. Programmed Neutral Switch Position: Switch operator with programmed neutral position arranged to provide a midpoint between the two working switch positions, with an intentional, time-controlled pause at midpoint during transfer. Adjustable pause from 0.5 to 30 seconds minimum, and factory set for 0.5 second unless otherwise indicated. Time delay occurs for both transfer directions. Disable pause unless both sources are live.

B.7 Source Quality Control

- 1. Factory Tests: Test and inspect components, assembled switches, and associated equipment according to UL 1008. Ensure proper operation. Check transfer time and voltage, frequency, and time-delay settings for compliance with specified requirements. Perform dielectric strength test complying with NEMA ICS 1.
- 2. Prepare test and inspection reports.
 - a. For each of the tests required by UL 1008, performed on representative devices. Include results of test for the following conditions:
 - i. Overvoltage.
 - ii. Undervoltage.
 - iii. Loss of supply voltage.
 - iv. Reduction of supply voltage.
 - v. Alternative supply voltage or frequency is at minimum acceptable values.
 - vi. Temperature rise.
 - vii. Dielectric voltage-withstand; before and after short-circuit test.
 - viii. Overload.
 - ix. Contact opening.
 - x. Endurance.
 - xi. Short circuit.
 - xii. Short-time current capability.
 - xiii. Receptacle withstand capability.
 - xiv. Insulating base and supports damage.

C Construction

C.1 Installation

1. Floor-Mounting Switch: Anchor to floor by bolting.
 - a. Install transfer switches on cast-in-place concrete equipment base(s). Comply with requirements for equipment bases and foundations specified in "Cast-in-Place Concrete."
 - b. Comply with requirements for seismic control devices specified in Section "Seismic Controls for Electrical Systems."
 - c. Coordinate size and location of concrete bases. Cast anchor-bolt inserts into bases.
 - d. Provide workspace and clearances required by NFPA 70.
2. Annunciator and Control Panel Mounting: Flush in wall unless otherwise indicated.
3. Identify components according to Section "Identification for Electrical Systems."
4. Set field-adjustable intervals and delays, relays, and engine exerciser clock.
5. Comply with NECA 1.

C.2 Connections

1. Wiring to Remote Components: Match type and number of cables and conductors to generator sets, control, and communication requirements of transfer switches as recommended by manufacturer. Increase raceway sizes at no additional cost to Owner if necessary to accommodate required wiring.
2. Wiring Method: Install cables in raceways and cable trays except within electrical enclosures. Conceal raceway and cables except in unfinished spaces.
 - a. Comply with requirements for raceways and boxes specified in "Raceways and Boxes for Electrical Systems."
3. Wiring within Enclosures: Bundle, lace, and train conductors to terminal points with no excess and without exceeding manufacturer's limitations on bending radii.
4. Ground equipment according to Section "Grounding and Bonding for Electrical Systems."
5. Connect wiring according to Section "Low-Voltage Electrical Power Conductors and Cables" and Section "Communications Horizontal Cabling."
6. Route and brace conductors according to manufacturer's written instructions and Section "Hangers and Supports for Electrical Systems." Do not obscure manufacturer's markings and labels.
7. Brace and support equipment according to Section "Seismic Controls for Electrical Systems."
8. Final connections to equipment shall be made with liquidtight, flexible metallic conduit no more than 18 inches in length.

C.3 Field Quality Control

1. Perform the following tests and inspections with the assistance of a factory-authorized service representative:
 - a. Visual and Mechanical Inspection:
 - i. Compare equipment nameplate data with Drawings and Specifications.
 - ii. Inspect physical and mechanical condition.
 - iii. Inspect anchorage, alignment, grounding, and required clearances.
 - iv. Verify that the unit is clean.
 - v. Verify appropriate lubrication on moving current-carrying parts and on moving and sliding surfaces.
 - vi. Verify that manual transfer warnings are attached and visible.

- vii Verify tightness of all control connections.
- viii Inspect bolted electrical connections for high resistance using one of the following methods, or both:
 - 1) Use of low-resistance ohmmeter.
 - 2) Verify tightness of accessible bolted electrical connections by calibrated torque-wrench method according to manufacturer's published data.
- ix Perform manual transfer operation.
- x Verify positive mechanical interlocking between normal and alternate sources.
- xi Perform visual and mechanical inspection of surge arresters.
- xii Inspect control power transformers.
 - 1) Inspect for physical damage, cracked insulation, broken leads, tightness of connections, defective wiring, and overall general condition.
 - 2) Verify that primary and secondary fuse or circuit-breaker ratings match Drawings.
 - 3) Verify correct functioning of drawout disconnecting contacts, grounding contacts, and interlocks.
 - 4) Electrical Tests:
- xiii Perform insulation-resistance tests on all control wiring with respect to ground.
- xiv Perform a contact/pole-resistance test. Compare measured values with manufacturer's acceptable values.
- xv Verify settings and operation of control devices.
- xvi Calibrate and set all relays and timers.
- xvii Verify phase rotation, phasing, and synchronized operation.
- xviii Perform automatic transfer tests.
- xix Verify correct operation and timing of the following functions:
 - 1) Normal source voltage-sensing and frequency-sensing relays.
 - 2) Engine start sequence.
 - 3) Time delay on transfer.
 - 4) Alternative source voltage-sensing and frequency-sensing relays.
 - 5) Automatic transfer operation.
 - 6) Interlocks and limit switch function.
 - 7) Time delay and retransfer on normal power restoration.
 - 8) Engine cool-down and shutdown feature.
- xx Measure insulation resistance phase-to-phase and phase-to-ground with insulation-resistance tester. Include external annunciation and control circuits. Use test voltages and procedure recommended by manufacturer. Comply with manufacturer's specified minimum resistance.
 - 1) Check for electrical continuity of circuits and for short circuits.
 - 2) Inspect for physical damage, proper installation and connection, and integrity of barriers, covers, and safety features.
 - 3) Verify that manual transfer warnings are properly placed.
 - 4) Perform manual transfer operation.

- xxi After energizing circuits, perform each electrical test for transfer switches stated in NETA ATS and demonstrate interlocking sequence and operational function for each switch at least three times.
- 1) Simulate power failures of normal source to automatic transfer switches and retransfer from emergency source with normal source available.
 - 2) Simulate loss of phase-to-ground voltage for each phase of normal source.
 - 3) Verify time-delay settings.
 - 4) Verify pickup and dropout voltages by data readout or inspection of control settings.
 - 5) Perform contact-resistance test across main contacts and correct values exceeding 500 microhms and values for one pole deviating by more than 50 percent from other poles.
 - 6) Verify proper sequence and correct timing of automatic engine starting, transfer time delay, retransfer time delay on restoration of normal power, and engine cool-down and shutdown.
 - 7) Ground-Fault Tests: Coordinate with testing of ground-fault protective devices for power delivery from both sources.
2. Verify grounding connections and locations and ratings of sensors.
 3. Coordinate tests with tests of generator and run them concurrently.
 4. Report results of tests and inspections in writing. Record adjustable relay settings and measured insulation and contact resistances and time delays. Attach a label or tag to each tested component indicating satisfactory completion of tests.
 5. Transfer switches will be considered defective if they do not pass tests and inspections.
 6. Remove and replace malfunctioning units and retest as specified above.
 7. Prepare test and inspection reports.
 8. Infrared Scanning: After Substantial Completion, but not more than 60 days after Final Acceptance, perform an infrared scan of each switch. Remove all access panels so joints and connections are accessible to portable scanner.
 9. Instrument: Use an infrared scanning device designed to measure temperature or to detect significant deviations from normal values. Provide calibration record for device.
 10. Record of Infrared Scanning: Prepare a certified report that identifies switches checked and that describes scanning results. Include notation of deficiencies detected, remedial action taken, and observations after remedial action.
 11. Follow-up Infrared Scanning: Perform an additional follow-up infrared scan of each switch 11 months after date of Substantial Completion.

C.4 Demonstration

1. Engage a factory-authorized service representative to train Owner's maintenance personnel to adjust, operate, and maintain transfer switches and related equipment.
2. Training shall include testing ground-fault protective devices and instructions to determine when the ground-fault system shall be retested. Include instructions on where ground-fault sensors are located and how to avoid negating the ground-fault protection scheme during testing and circuit modifications.
3. Coordinate this training with that for generator equipment.

D Measurement

The department will measure Transfer Switches as each individual assembly, acceptably completed.

E Payment

The department will pay for measured quantities at the contract unit price under the following bid item:

ITEM NUMBER	DESCRIPTION	UNIT
SPV.0060.05	Transfer Switches	EACH

Payment is full compensation for furnishing and installing transfer switches and for furnishing all labor, tools, equipment, materials, and incidentals necessary to complete the contract work.

28. Traction Elevators, Item SPV.0060.06.

A Description

A.1 Description of Work

This special provision describes the labor, materials, and equipment necessary to complete the fabrication, installation and testing of four heavy-duty traction passenger elevators.

A.2 Related Documents

Drawings and general provisions of the contract, including general and supplementary conditions, apply to this section.

A.3 Definitions

1. Authority having jurisdiction (AHJ): Local jurisdiction agency and/or department responsible for issuing certificates for use, testing and inspections.
2. Beneficial use: When the elevator is placed into service, may be prior to the site being ready for public use.
3. Burn-in testing: Continuous automatic cycling of the elevator for four (4) contiguous days under fully loaded conditions. Burn-in shall occur immediately following the elevator certification and prior to beneficial use and shall be performed under normal power for three (3) days and on backup power for 24 hours during non- revenue hours. Contractor shall submit a continuous report for the burn in event, which shall be generated from the elevator controller program.
4. Code: Codes, standards, publications, and other references listed in the following section.
5. Complete Set: Shop drawings shall be submitted as a complete set which includes, but is not limited to, all items in the "Submittals" section and all other reference to submittal requirements within this specification.
6. Contractor: The general contractor for the project/contract. The general contractor is responsible for all coordination between the various trades and associated specification sections for the elevator installation and operation. The general contractor is also responsible for all subcontractors to perform the work, testing and inspections as specified within this section.
7. Defective elevator work: Operation or control system failure, including excessive malfunctions, performances below specified ratings, excessive wear, unusual deterioration or aging of materials or finishes, unsafe conditions, the need for excessive maintenance, abnormal noise or vibration, and similar unusual, unexpected and unsatisfactory conditions.
8. Dwell time: The period of time the elevator is at a landing while the doors open, passengers transfer and doors close.
9. Device or a part of the equipment: References to a device or a part of the equipment applies to the number of devices or parts required to complete the installation.
10. Elevator: A hoisting and lowering mechanism equipped with a car or platform, which moves in guide rails or racks and serves two or more landings.

11. Elevator manufacturer/installer: The party selected under this contract to furnish and install the elevator as a subcontractor to the general contractor. The phrase elevator manufacturer and/or installer implies that the manufacturer is also the installer, or the installer is approved by the elevator manufacturer for the installation of the elevator as specified within this section.
12. Elevator nomenclature: As prescribed in ASME/ANSI A17.1 – 2016 - Safety Code for Elevators and Escalators.
13. Final acceptance: The point at which the owner accepts the elevator project as being complete, including all submittal requirements. This may be a different point in time than substantial completion.
14. Geared elevator: A traction machine-type elevator in which the energy from the motor is transmitted to the drive sheave through worm gearing. The motion of the car is obtained through friction between the suspension ropes and a traction sheave.
15. Heavy duty elevator: An elevator designed specifically for transportation system.
16. Interim maintenance: Maintenance from the point of substantial completion, but prior to acceptance by the owner.
17. Letter of certification: Submitted letter shall be notarized with requested compliance and signed by an officer of the manufacturer and/or installer as specified.
18. SDS: Safety data sheets, as defined by occupational safety and health administration (osha).
19. Notice to proceed (NTP): The date which the elevator installer is notified to proceed with the work.
20. OEM: Original equipment manufacturer.
21. Owner: Wisconsin Department of Transportation
22. Passenger elevator: An elevator used primarily to carry persons other than the operator and persons necessary for loading and unloading.
23. Project representative: Representatives from Wisconsin department of transportation, architects and engineers. Various submittals within this section require review, decisions and information from these representatives that provide resultant review status for the required submittals listed in this section.
24. Revenue service: The station or facility opening date.
25. Substantial completion: The point at which the elevator is ready for use, whether the site is finished or not. Jurisdictional inspection usually occurs at this time.
26. System: Includes all elevator components, equipment and incidentals specified within this section, unless otherwise used in context with a referenced system. The system is also inclusive of elevator components not specified in this section but provided with the manufacturer's elevator operating system.

A.4 Applicable Codes, Standards, Organizations and Publications

The latest edition of codes, standards and publications shall be used for all criteria listed within this section. In case of conflict between codes, regulation or standards, the most stringent requirement shall take precedence. In all cases, code shall be the governing factor. Elevator designs and installations shall be of the heavy-duty type and shall comply with the following:

1. International Building Code 2015 as adopted under Wisconsin department of safety and professional services (SPS) 361.05 and modified in chapters SPS 361 to 366.
2. American Society of mechanical engineers (ASME) and the American national standards institute (ANSI):
 - a. ASME/ANSI A17.1 2016 "Safety Code for Elevators and Escalators" (hereafter referred to as the code) as adopted under chapters SPS 318 and modified by this chapter.

- b. ASME/ANSI A17.2 2013 “Inspectors Manual for Elevators and Escalators”
 - c. ASME/ANSI A17.5-M 1991/CAN/CSA-B44.1 “Standard for Elevator and Escalator Electrical Equipment”
3. ANSI Z97.1 “American national standard for safety glazing materials used in buildings – safety performance specifications and methods of test”
 4. National Fire Protection Association (NFPA):
 5. NFPA No. 13, 70 and 72
 6. Americans With Disabilities Act (ADA)
 7. ADAAG 2010 “Accessibility Guidelines for Buildings and Facilities”
 8. American public transportation association (APTA-RT-EE-RP-003-04)
 9. American welding Society (AWS)
 10. American Society of testing and materials (ASTM)
 11. International standards organization, ISO 281/I, 1997 and later editions
 12. American federation of bearing manufacturers association (AFBMA), standards 9 and 11
 13. National Electrical Manufacturers Association (NEMA)
 14. The American insurance association
 15. Occupational Safety and Health Act (OSHA)
 16. International Code Council / American National Standards Institute (ICC/ANSI), A117.1 2013
 17. Building officials and code administrators international, Inc. (BPCA)
 18. Any additional requirements imposed by local agencies shall be incorporated into elevator installations.

A.5 Coordination Requirements

Coordination requirements shall include, but not be limited to, the following:

1. Alterations: Contractor shall coordinate any alterations required to accommodate the elevator with the owner.
2. Cab floor finish: Coordinate floor/finish at the elevator door sill finish elevation with the required pocket for sill installation and with other appropriate contractors and/or trades. Cab floor finishes shall be as selected by the architect.
3. Door rough openings: The elevator manufacturer/installer shall coordinate with the contractor for the elevator’s required rough opening until the rails and door frame are installed.
4. Electrical: Contractor shall coordinate all trades regarding the installation of CCTV, communications, smoke detectors, power and cab lighting requirements.
5. Field measurements: Contractor and elevator manufacturer/installer shall verify all field measurements for all elevator shafts prior to submitting the shop drawings, and immediately after each opening are prepared for the new elevator installation as indicated on the contract drawings. All shop drawings must reflect actual field condition and dimensions. All equipment shall be designed and modified to fit in the shaft, pit, overhead, and machine room.
6. Pit drainage: Provide a means to prevent water from accumulating in the pit for the elevator. Contactor shall coordinate all requirements and connections of sump pumps or drains with Authority Having Jurisdiction (AHJ).
7. Rigging plan: Installer shall supply a detailed rigging plan that is approved by the owner. Rigging plans shall include, but not be limited to, path of entry/egress, imposed loading on floor surfaces and structures, product data of devices to be utilized in the rigging process with reference dimensions and lifting capacities. Rigging plans shall be signed and sealed by a professional engineer registered in the State of Wisconsin.

8. Safety training: Installer shall attend appropriate safety training programs provided by the owner at no extra cost.
9. As-built drawings: Contractor shall provide revised contract drawings to reflect actual as-built condition including all structural, architectural, electrical, mechanical and plumbing conditions for the elevators. Submit no later than three (3) weeks after the elevators receive a certificate of operation for public use.
10. Lock cylinders:
 - a. All locks and keys shall be as per owner's current standard lock requirements and/or engineer approval.
 - b. Contractor shall verify with the engineer that the requirements for hardware have not been amended or superseded.
 - c. Contractor shall provide the engineer with length, finish and camming requirements of each cylinder required.
11. Methodology: The contractor shall meet with the owner and provide a written method of installation for approval.
12. Protection: During installations, and until elevator systems are fully operative, contractor shall make necessary provisions to protect systems from damage, deterioration and environmental conditions.

A.6 Related Work by Others

1. Provide 120V duplex waterproof GFCI receptacles in each elevator pit and machine room.
2. Provide mainline disconnect switches for each elevator in the machine room. Disconnect switches shall comply with National Electrical Code requirements, and shall be fused, externally operable and capable of being locked in the open position.
3. Provide auxiliary disconnect switches for each elevator in the machine room. Disconnect switches shall comply with National Electrical Code requirements.
4. Temperature in each machine room to be maintained between 55° and 90° Fahrenheit. Provide ventilation where necessary.
5. Provide a means to prevent water from accumulating in the pit for the elevator. Contractor shall coordinate all requirements and connections of sump pumps with Authority Having Jurisdiction (AHJ). Connection of the drain or sump to a sanitary system is prohibited.
6. Machine room door shall be self-closing and self-locking as required per A17.1 Code.
7. This is a department rule in addition to the requirements in ASME A17.1 section 2.7.3.4.1: The entrance to a machine room, control space, or control room shall be identified with a permanent sign. The lettering on the sign shall be at least 1-inch high and state "elevator machine room," or equivalent wording.
8. Machine room and hoistway pit lighting shall meet the requirements of the A17.1 elevator code.
9. All other equipment not normally in the scope of the elevator contract, normally supplied by other trades, and not specifically noted.

A.7 Quality Assurance

1. Elevator manufacturer and/or installer shall obtain and pay for all permits, licenses, fees and testing inspections, and perform such tests with all required equipment and material and/or retests as may be required for acceptance and approval of each elevator by the authority having jurisdiction. The elevator manufacturer and/or installer shall complete all retesting due to improper coordination, preparation or failure of previous tests at no additional cost to the owner.
2. Elevator manufacturer and/or installer shall notify the owner, engineer and proper inspectors a minimum of four working days in advance of the scheduled inspection to witness required testing. Supply the required personnel, equipment and materials for tests, inspections and final reviews at no additional cost to the owner.

A.8 Design Criteria

General: Elevators shall be designed with provisions for thermal expansion and contraction of complete elevator assemblies.

Manufacturer/installer of elevator systems shall provide system that works with the design as drawn and with performance requirements specified. Provide standard systems to meet requirements of contract documents.

Operational Requirements: Hours of operation shall be considered as 24 hours per day, 7 days per week.

Environmental requirements:

1. Elevators shall be capable of operating with full-specified performance capability while exposed to the following climatic and environmental conditions.
2. Exterior installations: elevators shall be designed to operate while exposed to the natural elements of weather, including sunlight, rain, slush, snow and ice; all conditions of relative humidity while exposed to salt, de-icing chemicals, airborne dust, and debris, and corrosive elements; and in a dry bulb temperature range of -25 to +120 degrees Fahrenheit.

Seismic zone requirements: n/a

Bearings:

3. Motor limit: rigid mount, 15 ips; flex mount, .2 ips.
4. Bearings shall be rated for an AFBMA I10 life as specified, under a fluctuating bearing load. All bearings shall have basic dynamic load ratings.

Fasteners:

5. Fasteners shall be compatible with materials being fastened.
6. Fasteners shall be furnished with self-locking nuts or retaining rings (spring washers or toothed discs).
7. Fasteners shall be equal to, or of greater corrosion resistance than, the most corrosion resistant metals being fastened.

Ride quality:

Maintain the following ride quality requirements for all the passenger elevators:

Noise levels inside the car shall not exceed the following:

8. Car at rest with doors closed and fan off – 40 dba.
9. Car at rest with doors closed and fan running – 55 dba.
10. Car running at high speed and fan off – 50 dba.
11. Door in operation – 60 dba.
12. The elevators shall have a maximum vibration of 30 milli-g's in the x, y and z axis measured with an A95 filter.

A.9 Submittals

Submittals and shop drawings shall be furnished no later than 6 weeks after the contractor has been provided the notice to proceed unless otherwise directed by the owner. Prior to commencing shop drawing submittals and design on elevators to be installed in new hoistways, examine the hoistway conditions to verify that no irregularities exist that would affect the design including:

1. Hoistway size and plumbness.
2. Anchor brackets.
3. Sill support.
4. Pit depth.
5. Overhead clearance.

Submittals and shop drawings shall be furnished as a "complete set" for each item as required for submittal within this section. Six sets and an electronic set of each submittal shall be provided unless additional sets are specifically required elsewhere in the specifications. Incomplete sets are not acceptable.

1. The contractor shall submit a letter from the elevator manufacturer indicating that the installer is approved and authorized by the manufacturer for the installation of the elevators as specified. The letter shall be signed by an officer of the manufacturer. If the manufacturer intends to install the elevators, it shall be submitted in letter form and signed by an officer of the manufacturer.
2. Submit chart with proposed dates for the delivery and installation for each elevator. The chart shall provide the following after shop drawings have been approved (assume a 3-week review period by the engineer):
3. Weeks for fabrication time and expected delivery to site.
4. Weeks for installation time based on consecutive installation of elevators and specify whether elevator installation shall be consecutive or simultaneous.
5. Weeks for any other critical items.
6. Weeks for inspection and testing and/or retesting.

Product data: Submit the equipment manufacturer's product data for all products and systems proposed for use. Product data shall include, but not be limited to, the following:

1. Manufacturer's catalog cuts: fixtures, 2-speed exhaust fan, door operator, full door height electric eye, lighting fixtures, controller, CCTV camera, car top control station, remote intercom system for communication between remote machine rooms and the top of car, door weather stripping and interior car wall panels.
2. Electrical characteristics and connection requirements.
3. Expected heat dissipation of elevator equipment in machine room and control areas (btus/hr.) Based on two-hundred and forty (240) starts per hour.
4. Maintenance programs: within sixty (60) days after notice to proceed, and prior to installation, submit detailed interim and revenue service maintenance programs, showing functions to be performed and their scheduled frequency.
5. Machine performance data sheets.
6. Pre-acceptance test forms.
7. All proprietary equipment shall be clearly identified in the manufacturer's literature and manuals.

Shop drawings: Provide standard shop drawings for fabrication, installation and erection of all parts of the work. Provide plans for each equipment room, hoistway, and car in addition to elevations, details of anchorages, connections and accessory items. Drawings shall include, but not be limited to, the following:

1. Car guide rails, buffers and other components in the hoistway.
2. Maximum rail bracket spacing. Rail brackets shall be located based on actual hoistway construction as shown in the contract documents.
3. Maximum loads imposed on guide rails requiring load transfer to the building structure.
4. Loads on hoisting beams.
5. Clearances and travel of car and counterweight runby.
6. Clear inside hoistway and pit dimensions.
7. Location and sizes of access doors, hoistway entrances and frames.
8. Car and hall signal and operating features, including dimensioned drawings of the car control panel, position and floor indicator landing control stations, firefighter's keyed switch, access key switch, combination position indicator and hall lantern, supervisory panel, power operation intercom and other related information.

9. Remote wiring layouts for each elevator.
10. Refuge space on top of car and pit.
11. Control room, machine area, pit and hoistway layout.
12. Cab design, dimensions and layout, showing the arrangement of the elevator control panel, doors, direction indicator, intercom, and other related items. Provide reflected ceiling plan for the car locating the exhaust fan, emergency exit, lighting and other related information. Design information shall include:
 - a. Details of car interior wall panels, including material type, panel sizes and thicknesses, installation and anchoring details.
 - b. Sections and details of car roof, including the relationship of the emergency exit and hatch with the exact location of the crosshead.
13. Hoistway door and frame details.
14. Complete assembly details of machines, mountings, machine beam assemblies, and beam assemblies, governors, safeties, and counterweights. Provide all associated load calculations.

Samples: submit samples of materials and products requiring color or finish selection, including but not limited to, the following:

1. Stainless steel: samples shall be provided for landing control stations, door frames, doors, interior car panels, and handrails with wall connections. Samples shall be no less than 3" by 5" and shall be labeled on the unfinished side with the finish, gauge, location and elevator for which the material will be used.
 - a. Submit to the authority having jurisdiction elevator plans and documents according to their requirements. The contractor shall provide a copy of the letter of transmittal to the engineer of all documents that were provided to the authority having jurisdiction by the elevator manufacturer/installer. When the elevator permit number is assigned for each elevator, the number shall be forwarded to the engineer.
 - b. Burn-in report: submit according to "Acceptance and Warranty" section. Contractor shall submit a continuous report for the burn-in event, which shall be generated from the elevator controller program.

A.10 Operating and Maintenance Manuals

Maintenance manuals: prior to installation, installer shall submit three (3) preliminary complete sets of operation and maintenance manuals for approval six weeks after notice to proceed. After engineer's approval and prior to beginning of acceptance testing, six (6) sets of the approved manuals shall be provided by the installer. After approval and substantial completion, the final manuals are due no more than 30 days after punch list items are completed. The manuals shall include the following:

1. Complete table of contents.
2. Complete instructions regarding operation and maintenance of the elevator equipment. Include complete illustrated, exploded views of all assemblies and a complete, illustrated exploded view for identifying all system parts.
3. Complete nomenclature of replaceable parts, part numbers, current cost and warehouse location. If product source is another vendor, provide name and address of other vendor.
4. Sample copies of a proposed preventive maintenance chart.
5. Descriptions of safety devices.
6. Safety rules, tests and procedures, including testing of all systems and subsystems.
7. Procedures for adjusting all elevator components, including pictorials.
8. Troubleshooting techniques.
9. Detailed lubrication and cleaning schedule indicating weekly, monthly, quarterly, semiannual and annual lubrication. Include a description of each lubrication point, lubrication type and specification.

10. Control and schematic electrical wiring diagrams of controller, including wiring of safety devices to connections with remote indication and control panels for the elevator.
11. Electrical layout showing placement of lighting, light switches, receptacles, fixtures, disconnect switches and convenience outlets in control areas, machinery spaces and pits.
12. Complete detailed drawings and wiring diagram of elevator system.
13. The installer shall be required to provide certification, in writing and signed by an officer of the organization, that owner shall be provided with copies of any and all information, correspondence, bulletins, newsletters, manuals, techniques, procedures, drawings, sketches and any other documents related to maintenance, safety, operations, design changes, modifications, retrofits, etc. Which relate to any part, component, equipment, system subsystem or material and services applicable to the elevators provided.

All of the above referenced information shall be provided as it pertains to the original installation.

Referenced material shall be provided within 30 days of publication or internal distribution by the elevator manufacturer. The material, even if labeled proprietary, shall be delivered to the owner without prejudice or delay and at no additional cost.

1. The entire manual shall also be provided in an electronic format on USB that is acceptable to the engineer.
2. SDS and product data sheets shall be submitted with an index listing each product, application method of product, approximate quantity of product per elevator, and the component the product is applied to or associated with. Allow six weeks for review of SDS by the engineer.

A.11 Training

1. The installer will provide 40 hours of local training for the owner and his representatives in the proper use, operations, and daily maintenance of elevators. Review emergency provisions, including emergency access and procedures to be followed at the time of failure in operation and other building emergencies.
2. Train owner personnel in normal procedures to be followed in checking for sources of operational failures or malfunctions. Provide manuals for all material covered in the training program. This training will take place at the discretion of the owner at any time prior to the end of the warranty period.

A.12 Temporary and Permanent Electrical Power Services

Contractor shall provide and coordinate all temporary power which shall be available to the installer at the time of installation. Permanent power shall be made available for testing. All power shall be provided at no cost to installer.

1. Power for the elevator drive systems shall be 480 volts, 3 phase, 4 wire, 60 hertz terminating in a disconnect switch within sight of the controller. The lift motor starting current shall not exceed 250% of the full load amperage.
2. Power for lighting and GFCI receptacles shall be 120 volts, 3 phase, 4 wire, 60 hertz terminating at the elevator controller location.
3. Separate disconnect for cab lighting and wiring to cabs shall be 120 volts, 1 phase, 4 wire, 60 hertz terminating in a disconnect switch within sight of the controller.
4. Separate service for ancillary elevator equipment shall be provided where required.

A.13 Product Delivery, Storage and Handling

The contractor shall coordinate delivery to the site, or other dry storage area acceptable to the engineer, and provide adequate secured storage acceptable to the elevator manufacturer, installer and the engineer for the new elevators. Stored elevator and related equipment shall be insured as required by the contract documents.

1. Deliver components with factory-installed wooden skids and lifting lugs, and pack components in factory-fabricated protective containers.
2. Store materials in original protective packaging in a dry area protected from weather.

3. Protect equipment and exposed finishes during transportation, storage and erection against damage and stains.
4. Handle components carefully to avoid damage to components, enclosures and finish.
5. Comply with the equipment manufacturer's rigging instructions for unloading components and moving components to their final location for installation.
6. Spare parts shall be delivered to location as determined by the owner.
7. The owner shall bear no responsibility for the materials, equipment or tools of the contractor and shall not be liable for any loss thereof or damage thereto.

A.14 Acceptance and Warranty

Contractor shall submit the burn-in report prior to final acceptance. The burn-in report will be reviewed against the manufacturer's recommended tolerances. Failure to meet the manufacturer's tolerances shall require immediate corrective actions and a repeat of the burn in report until acceptance.

A.14.1.1 The equipment manufacturer shall warrant in writing that all equipment manufactured and installed under this specification, for a period of five years from the date of final acceptance by the owner, be free of defects in design, materials and workmanship, under normal use and service.

A.14.1.2 The warranty shall include materials and labor necessary to correct defects. Defects shall include, but not be limited to, noisy, rough or substandard operation; loose, damaged or missing parts; and fluid leaks.

A.15 Warranty Maintenance Requirements

Elevator Installer shall provide five years preventative maintenance service to coincide with the warranty period.

Service shall include but not limited to monthly preventive maintenance, repair or replacement of worn or defective components, lubrication, cleaning, and adjusting as required for proper elevator operation at rated speed and capacity. Parts and equipment provided shall be the same as those used in the manufacture and installation of original equipment.

1. The following service is also required to be specified in the design documents during the maintenance period:
2. Perform maintenance, including emergency callback service, during normal working hours.
3. Provide lubrication of parts and equipment components as per the equipment manufacturer's recommendation. Charts shall be provided for each elevator indicating when services are provided.
4. Perform work without removing elevator from service during peak traffic periods.
5. Provide 24-hour emergency service during the maintenance period consisting of prompt response (within 2 hours) to emergency request by telephone or other communication from owner or designated representative if an elevator is inoperable or in case of injury, entrapment, or potential injury to persons.
6. Unlimited regular time callbacks shall be included with a required response time of one hour.
7. Annual clean down of the elevator and hoistway enclosure is required. Make necessary arrangements with owner in order to minimize any inconvenience and reduction of service.

Reporting: Detailed monthly records of tasks performed shall include names of individuals performing the tasks, date and time performed, and other pertinent data. Installer shall be required to conform to the requirements of the owner's database maintenance system.

A.16 Measurements and Drawings

Any drawings or measurements included with the bidding material shall be for the convenience of the bidders only. Complete responsibility for detailed dimensions lies with the contractor.

In the execution of the work on the job, the contractor shall verify all dimensions with the actual conditions.

Where the work of the Elevator Contractor is to join with another trade, the shop drawings shall show the actual dimensions and the method of joining the work of the two trades.

A.17 Keys

Upon the initial acceptance of work specified by the Contract Documents on the unit of vertical transportation equipment, deliver to the Owner, four keys for each new key-operated device that is provided.

B Materials

B.1 Elevator Manufacturers

Manufacturers: Subject to compliance with requirements, provide products by one of the following:

1. Hollister Whitney.
2. Minnesota elevator, inc.
3. Schumacher elevator.

B.2 Passenger Elevators Summary

1. Elevator number: 01, 02, 03 and 04
2. Elevator use: passenger
3. Contract load, in pounds: as per contract drawings
4. Contract speed, in fpm: as per contract drawings
5. Loading class: A
6. Travel distance: as per contract drawings
7. Serves: as per contract drawings
8. Number of stops: as per contract drawings
9. Number of openings: as per contract drawings
10. Machine room location: overhead above hoistway
11. Machine type: as specified
12. Car and hoistway door size: as per contract drawings
13. Car and hoistway door type: as per contract drawings
14. Car and hoistway door operation: power high-speed, heavy duty (minimum opening speed 3.0 fps)
15. Hoistway entrance: as specified.
16. Cab enclosure: as specified.
17. Door-reversal device: non-contact door reversal device
18. Car Operating Panel: Stainless steel with vandal resistant features
19. Car position indicator: Stainless steel with vandal resistant features
20. Car direction indicator: Stainless steel with vandal resistant features
21. Hall call stations: Single riser, stainless steel with vandal resistant buttons
22. Self-leveling
23. Communication system: "hands-free"
24. Provide keyed switch in car operating panel or hall pushbutton station as directed to shut down elevator.

B.3 Systems and Components

General: Elevator equipment furnished under this Section shall conform to the material, functional, clearance, and safety requirements of ASME A17.1.

1. New equipment shall be designed and fabricated to fit within the hoistway structure as indicated on the Contract Drawings while maintaining code required clearance requirements.
2. Elevator equipment shall be third party, non-proprietary in nature.

Provide manufacturer's standard elevator systems. Where components are not otherwise indicated, provide standard components published by manufacturer as included in standard pre-engineered elevator systems and as required for complete system.

B.3.2 Fixed Hoistway Components:

Inserts: Furnish required concrete and masonry inserts and similar anchorage devices for installing guide rails, machinery, and other components of elevator work where installation of devices is specified in another section.

Buffers:

1. Provide buffers (type selected by manufacturer) complete with all required supports and blocking.
2. Buffers shall comply, in all respects, with the requirements of ASME A17.1.
3. Provide permanent buffer marking plate, which indicates the manufacturer's name, identification number, rated impact speed and stroke.

Guide rails:

4. Provide guide rails, brackets and backing fabricated from steel.
5. Rails shall be machined, steel t-section guide rails of suitable size and weight for the application.
6. For concrete hoistways, furnish rail brackets and provide inserts for installation by concrete subcontractor.
7. Brackets shall be used to support the rails from hoistway framing and/or inserts. The rails shall be attached to the brackets by heavy clamps or clips.
8. Provide rail backing where the vertical distance between the support framing is greater than 14'-0" and no intermediate support framing is shown on the drawings.

Stopping devices:

1. Normal terminal stopping devices, conforming to the requirements of section 2.25 of ASME A17.1, shall be provided to stop the car automatically from any speed obtained under normal operation within the top and bottom over travels independent of the operating devices and the buffers.
2. Stopping devices shall have rollers with rubber or similar composition tread to provide silent operation when actuated by the fixed cam on the car; device enclosures shall be rated NEMA 4.

Interlocks, contacts and unlocking devices:

1. Equip the elevators hoistway door with a positive interlock which shall prevent the operation of the elevator unless all elevator doors are closed and maintained closed when elevator is away from the landing. The interlocks shall also prevent the opening of a hoistway door from the landing side unless the car is within the landing zone and is either stopped or being stopped at that level. Design interlocks so that they are not easily accessible from the landing side.
2. Provide electric contacts on top emergency exit, emergency hoistway access entrance, and governor access panel to prevent the operation of the elevator when the electric contacts are not closed.

Hoistway/car door hangers, sheaves and tracks:

1. Provide a sheave type two-point suspension hanger and track for each hoistway and car door. Sheaves shall be hardened steel with polyurethane tire, not less than 3 1/4 inches in diameter with sealed grease packed precision ball bearing.
2. The up-thrust shall be taken by a roller mounted on the hanger and arranged to ride on the underside of the track.
3. The track shall be of formed cold rolled steel or cold drawn steel and shall be rounded on the track surface to receive the hanger sheaves. The track shall be removable and shall not be integral with the header.

Stop switches: Provide readily accessible switches for stopping and maintaining the elevator out of service in pit, on top of car station and on the in-car operating panel.

Pit ladder: Provide non-combustible steel pit access ladder for each elevator.

1. The ladder shall extend not less than 48 inches above the sill of the access door.
2. The ladder rungs, cleats, or steps shall be a minimum of 16 inches wide.
3. The ladder rungs, cleats, or steps shall be spaced 12 inches \pm 1/2 inches on center, shall be provided to not less than the height of access door sill, and shall be designed to minimize slipping (e.g., knurling, dimpling, coating with skid-resistant material, etc.).
4. A clear distance of not less than 4 1/2 inches from the centerline of the rungs, cleats, or steps to the nearest permanent object in back of the ladder shall be provided.
5. The ladder and its attachments shall be capable of sustaining a load of 300 lb.
6. If obstructions are encountered, then a retractable ladder may be used instead.

B.3.3 Hoistway Entrance Structures

Frames: Entrance frames shall be of welded and mitered corners ground smooth construction for complete one-piece unit assembly. All frames shall be securely fastened to fixing angles mounted in the hoistway and shall be of 2 mm type 316 stainless steel. Provide an additional type 316 stainless steel sill angle support.

Hoistway Sill: The sill shall be type 316 stainless steel.

Sill support angles: 3/8" minimum stainless steel, with adjustable slots required for leveling the sill with the finish floors. Entrance sill shall be mounted direct to the sill support using stainless steel screws.

Doors: Entrance doors shall be of hollow metal construction with vertical internal channel reinforcements. Panels, framing, operating levers, and integral hardware shall be type 316 stainless steel; panel shall be 2mm and have a No. 4 finish.

Entrance Finish: Finish shall be type 316 stainless steel #4 finish.

Sight guards: Type 316 stainless steel.

Fascia:

1. Shall be type 316 stainless steel.
2. 16-gauge steel fascia plates shall extend at least the full width of the door and be secured at hanger support and sill with oval head machine screws.
3. Provide fascia plates where the clearance between the edge of the loading side of the platform and the inside face of the hoistway enclosure exceeds the code allowed clearance.

Toe Guards:

1. 16-gauge steel toe guards to extend 12 inches below any sill not protected by fascia.
2. The toe guards shall extend the full width of the door and shall have a straight vertical face, extending below the floor surface of the platform.

3. The lower portion of the guard shall be bent back at an angle not less than 60 degrees nor more than 75 degrees from the horizontal.

Dust covers: 16-gauge stainless steel, extending 6" above any header not protected by fascia.

Hoistway access switch: Install a cylindrical type keyed switch at top and bottom terminal landing in order to permit the car to be moved at slow speed with the doors open. Locate the switch in the terminal hall call station for each elevator. This switch is to be of the continuous pressure spring-return type and shall be operated by a cylinder-type lock having not less than a five (5) pin or five (5) disc combination with the key removable only in the "off" position. The lock shall not be operable by any key which operates locks or devices used for other purposes in the building and shall be available to and used only by inspectors, maintenance men and repairmen.

Floor designation: Provide raised floor designations with braille signage, permanently attached to the inside face of the hoistway door frame. Floor number designations and braille shall be 2 inches high with contrasting color background. Floor designations shall be provided on both sides, centered on the entrance frame at 60 inches above finished floor to comply with ADA requirements.

Provide sill mounted closers at all landings.

Provision for unlocking hoistway doors using a standard elevator "drop key" shall be provided at each landing.

B.3.4 Elevator Machines

Provide variable-voltage, variable-frequency, AC-type or variable-voltage, DC-type hoisting machines. Provide solid-state power converters.

1. Provide non-regenerative system.
2. Limit total harmonic distortion of regenerated power to five (5) percent per IEEE 519.
3. Provide means for absorbing regenerated power when elevator system is operating on standby power.
4. Provide line filters or chokes to prevent electrical peaks or spikes from feeding back into building power system.
5. Provide means to prevent unintended car movement complying with A17.1 section 2.19.2.2.

B.3.5 Geared Elevator Traction Machine

General construction: The hoisting motor shall drive a grooved sheave through a worm and gear.

Motor: The hoisting motor shall be reversible alternating current, operated through variable voltage variable frequency drive. Motor speed shall not exceed 1750 rpm. It shall be designed to withstand the loads encountered in elevator service, with capability for 120 starts per hour at the contract load and speed without overheating. The motor shall be flange-mounted directly to the gear or brake housing or shall be foot-mounted to a rigid bedplate.

Brake: Disc or drum brake shall be securely mounted to the shaft and shall run concentric to the shaft. Disc or drum shall be machined to obtain a smooth and accurate face. The brake shall be spring actuated, direct current, electrically released, heavy construction with proper braking area for the load and speed specified. The brake shall be provided with sufficient power to stop and hold the car with full contract load. Drum brakes shall have two (2) shoes actuated by two separate compression springs. Disc brakes shall be of caliper or multiple disc design

Worm and high-speed shaft: The worm gear shall be accurately machined from a heavy ring casting of special gear bronze and shall have accurately hobbled teeth. Brake and motor shall be coupled to worm shaft so as to be removable without removing worm.

Gear and low-speed shaft: The gear, spider, and sheave rotor assembly shall be mounted to a shaft supported by sleeve or anti-friction bearings of ample capacity, or with heavy anti-friction bearings to on a rigid shaft. The gear shall be fastened to the spider through shoulder bolts in reamed holes, or through electron beam welding.

Sheave: The sheave material shall be accurately machined of semi-steel of hardness BHN 220-250. It shall be firmly pressed onto its shaft.

Gear housing: The gear housing shall be divided horizontally at the centerline of the shaft to provide access to the worm gear. Suitable drain plugs and overflow pipes shall be provided.

Mounting: The gear housing, brake support and motor support (if foot-mounted motor) shall be mounted on a rigid bedplate.

Alignment of high-speed shafts: Motor, brake and worm shafts shall be accurately aligned in the factory for total indicator readout not exceeding .007" tir. Flange-mounted motors shall be aligned with the gear housing through machined registers. Foot-mounted motor alignment must be checked again after installation in the building, and when full load is applied; if alignment is not within the .007" tir specified, then the motor, brake pulley and worm shaft are to be re-trammed on site.

Alignment of worm and gear: There should be no hard contact with worm on either corner or edge of gear tooth. Machines with adjustable sheave shafts shall have worm and gear this alignment field checked per the manufacturer's recommendation after the machine is set and load applied.

Dynamic balance: The worm and its shaft, and the sheave, gear and gear spider shall be dynamically balanced as required to eliminate any source of noise or harshness.

Guard all exposed hoisting ropes in machine room with 14 gauge covers. The covers shall have no sharp edges and be properly mounted off the hoisting machine and drive sheaves to prevent deflector vibration.

Span the distance between the car and counterweight with an accurately grooved deflector sheave. Provide sheave guards to prevent ropes from jumping off grooves.

Approved manufactures or approved equal:

1. Hollister Whitney
2. Titan

Machine shall comply with ASME A17.1, including the following, or approved equal, rope grippers:

1. Draka Rope Brake.
2. Hollister-Whitney Rope Gripper.

B.3.6 Machine Beams

Provide framing to support elevator hoisting machine and deflector sheaves from the building structure. Comply with section "metal fabrications" for materials and fabrication.

B.3.7 Counterweight

Counterweight shall consist of a steel frame welded or bolted together and necessary steel weight sections. These weights sections shall be held securely in place within the frame.

B.3.8 Car Governor

Provide overspeed governor rated for the duty of the elevator specified and to operate the car safely.

Locate the governor where the car or the counterweight in case of over travel cannot strike it, and where there is adequate space for full movement of governor parts.

An electrical governor overspeed protective switch that, when operated, shall remove power from the driving machine motor and brake before or at the time of application of the safety.

Seal and tag the governor with the running speed, tripping speed and date last tested as required by the elevator code.

B.3.9 Tensioning Sheave

Provide tension sheave according to the equipment manufacturer's governor and car safety loading requirements.

B.3.10 Guide Shoes

Roller guides shall be mounted on top and bottom of the car and counterweight frames to engage the guide rails and provide a smooth ride.

B.3.11 Elevator Cab

Provide cab with overall height of 9'-0" with an 8'-6" clear interior.

Car frame:

1. Welded or bolted steel channel and steel sheet construction. Reinforce canopy/ceiling construction as required to maintain loads applied during car top inspection.
2. A suitable car frame shall be provided with adequate bracing to support the platform and car enclosure. The buffer striking plate on the underside of the car-frame platform assembly must fully compress the buffer mounted in the pit before the plunger reaches its lower limit of travel.
3. Provide welded or bolted ASTM 123 galvanized or type 316 stainless steel channel uprights affixed to crosshead and plank channels with welded or bolted bracing members and gusset plates which will remove strain from car enclosure.
4. Canopy and ceiling panels shall be sectionalized and arranged to accommodate installation of the top-of-car access hatch.
5. The top of car enclosure shall be appropriately marked to designate the refuge space(s) according to ASME A17.1. Elevator contractor shall coordinate with general contractor to determine precise extents of refuge space.

Platform:

1. Heavy loading type: the car platform shall be arranged to accommodate one-piece loads weighing up to 25% of the APTA rated load, such as wheeled food carts, hand trucks, etc.
2. The platform shall be type 316 stainless steel.
3. Platforms shall be dampened and fireproof.
4. A 14-gauge stainless-steel toe guard shall be provided at each car entrance side of the platform, extending the full width of each door, plus 4".
5. The platform toe guard shall be fastened to the car threshold and sufficiently braced to the underside of the platform to withstand the loads specified in section 2.15.9.4 of ASME A17.1.
6. The bottom 3" of the toe guard shall return toward the center of the hoistway at a 15° angle.

Cab flooring: Appropriate floor materials include:

1. Chemical resistant urethane
2. Stainless Steel checkered plate
3. Clear epoxy resin with vinyl chips

Seamless and resilient elevator cab flooring shall be poured or laid according to manufacturer's instructions over a minimum of one 3/4" thick marine grade tongue in groove plywood substrate.

Resilient flooring systems shall be self-extinguishing, have 200°F. Heat resistance, 11,700 psi compressive strength, 2,200 psi tensile strength, and 5,000 psi flexural strength.

Walls: As specified on VT drawings.

Ceiling: The clear height under the ceiling canopy shall be a minimum of 8'-0". Ceiling canopies shall be stainless not less than 0.109" nominal thickness (12ga).

Ventilation: 2-speed exhaust fan. Finish and material of fan enclosure and blade shall match the finish and material of the ceiling having a NEMA 4X rating. Exhaust blowers shall be designed with a hood.

Sling:

1. Stainless-steel sling shall consist of an upper crosshead, vertical stiles, and lower bolster, with gusset plates and diagonal bracing in such a manner that no strain will be transmitted to the elevator car.
2. Buffer strike plates shall be fabricated from hot-dip galvanized steel or stainless steel and mounted to the underside of the bolster.

Car guides: Provide roller guides or polymer-coated, non-lubricated sliding guides at top and bottom of car.

Car safety:

1. Provide a governor actuated mechanical safety device mounted under the car platform and securely bolted to the car sling. The car safety shall be sized for the capacity and speed noted herein.
2. When tripped, the safety mechanism shall engage the rails with sufficient force to stop a fully loaded car with an average rate of retardation within the limits given the ASME code for the capacity.
3. Install a car safety marking plate of corrosion resistant metal and, in addition to the data required by the ASME code, indicate the manufacturer's name and manufacturer's catalog designation number for safety.
4. Make provisions to release the car safety. In no event shall the safety be released by downward motion of the car. Raising the car to reset the safety shall be allowed.
5. Provide an electrical safety plank switch that will interrupt the power to the hoist machine when the safety is set. Resetting the plank switch shall be separate from resetting the safety jaws.

Car doors: As indicated on drawings - 14-gauge stainless-steel frame and stainless-steel no. 4 finish doors, fabricated in sections not less than 1¼" thick, reinforced to accept hangers, guides, interlocks, and doors closers; top edges of solid, reinforced, flush, non-adjustable construction, pre-drilled to accept hangers and roller assemblies.

Door operator equipment: Provide a GAL MOVFR-HSL or approved equal door operator with VVVF drive and the following features:

1. 1/2 hp motor and heavy-duty sprocket, chain, belt, and sheaves.
2. Closed loop regulated speed performance.
3. Hand-held keypad programming.
4. Adjustments can be stored in the keypad and downloaded to another operator.
5. Door obstruction reversal.
6. Optical cams with led indicators.
7. Test switches for open, close, nudging and speed zone set up.
8. Universal inputs for open, close, and nudging.
9. Reversing switch to back up the door reversal device.

Door hanger, sheaves and track assembly:

1. General: Car and hoistway doors shall each be supported by two-point suspension hanger and track assembly, as recommended by the manufacturer for use with the specified door operator.
2. Sheaves: Hardened steel, not less than 3¼" in diameter with sealed grease packed precision ball bearings.
3. Tracks: Formed cold-rolled or cold-drawn galvanized steel or zinc dichromium coated, rounded on the track surface to receive the hanger sheaves. Tracks shall be removable and shall not be integral with the header.
4. Door up-thrust shall be absorbed by a roller mounted on the hanger and arranged to ride on the underside of the track.

Door protective devices: Provide a non-contact door reversal device with light immunity. The door reopening device shall cause both the car and hoistway doors to reverse, should they detect an obstruction in the elevator entrance and shall be, tri-tronics, "w" series door edge, or approved equal. The device electrical wiring shall be supplied with quick disconnects terminals to facilitate replacement. The infrared curtain detector shall include the following:

1. An infrared curtain detector integrated with the operator which will cause both the car and hoistway doors to reverse, should it detect an obstruction in the elevator entrance.
2. A protective infrared detector field extending from 1 1/2" above the car sill to a height of 68".
3. A fail-safe control system to prevent the doors from closing in case of power loss to the detector.
4. A one-piece full door height protective lens cover designed to be completely waterproof and to withstand impact, abrasion and vandalism.

Car door interlock:

1. Car doors shall be equipped with an electric interlock, which will prevent automatic operation of the elevator unless the car door is in the "closed" position.
2. Car door interlock devices shall not be accessible from the inside of the car or from the landing during normal elevator operation.
3. Retiring cams used to actuate interlocks shall be securely fastened to the car structure and shall be designed to operate without excessive noise, shock or jar.
4. Electric contacts, non-auto-resetting type, shall be provided at top-of-car access hatches to prevent operation of the elevator when the hatch is open.

Emergency exit: Provide a top emergency exit which complies with code requirements.

Car lighting:

1. LED ceiling light fixtures shall be used.
2. The led lighting system shall be manufactured by man-d-tec, UL listed, model solobeam-6 (4100k), or approved equal.
3. In case of power loss, a minimum of two (2) lighting fixtures shall be "on" using the integrated power supply and emergency battery backup providing minimum illumination and duration requirement as per code.

Handrails:

1. 1-1/2 inches outside diameter type 316 stainless steel #4 brushed finish, installed at the side and rear walls of the cab with the handrail top height to meet ADA requirement.
2. Handrails shall have three (3) points of attachment on the side walls of the cab.
3. Handrails shall be removable from inside the car.

Top of car inspection station:

1. A top-of-car inspection station shall be mounted in a NEMA 4X enclosure on top of each car.
2. The device shall be activated by an inspection switch and, at a minimum, shall include:
 - a. "up", "down", and "common" control buttons
 - b. "stop" switch
 - c. A 110-volt GFCI duplex receptacle
 - d. Fire service indicator
 - e. NEMA 4x rated work light with wire guard, controlled via local on/off switch
 - f. An indicator light and a warning buzzer that shall signal phase I – fire emergency recall operation.
3. Car top illumination shall not be less than 10-foot candles as required per A17.1 Code.
4. When the top-of-car station is operational, all operating devices, including hall call stations and the car operating panel, shall be inoperative.

B.3.12 Fixtures and Signal Equipment

General: Hall fixtures, including but not limited to call stations, shall be of heavy-duty stainless-steel construction; enclosures and exposed faces shall be watertight, rated NEMA 4. Access requirements: location and arrangement of fixtures shall comply with applicable accessibility requirements.

Provide hall-call and car-call buttons that light when activated and remain lit until call has been fulfilled. Fabricate lighted elements with long-life incandescent lamps and acrylic or other permanent, non-yellowing translucent plastic diffusers or LEDs. No name plates or logos are permitted where they can be seen by the general public.

Main Car Operating Panel (COP):

1. Car operating panel: A type 316 stainless steel #4 vertical finish panel shall be provided with vandal resistant push buttons designed to bottom out against the panel plate and not the contacts, key switches.
2. Provide one car swing operating panel integral with a stationary return panel.

The COP shall include:

1. A call button for each floor served.
2. Door open button/door close button.
3. "alarm" button (illuminating jewel).
4. "emergency stop" key-switch.
5. Door hold open button. Door hold button shall lock out the elevator for ninety (90) seconds or until door closed button is pressed.
6. Fire service panel
7. Service cabinet
8. All other code-required features.

Engrave the car operating panels with the following:

1. No smoking: minimum 1" high lettering and graphic symbol
2. Elevator number over operating buttons: minimum 1/4" high lettering.
3. Elevator capacity: minimum 1/4" high lettering.
4. Firefighters operating instructions: minimum 1/8-inch-high lettering.

Service Cabinet:

1. Provide a service cabinet with a locked flush hinged or sliding door and integral certificate frame.
2. Certificate frame shall have durable plexiglas window and be accessible from backside of locked door. Minimum window size, to be approved by the owner.

Cabinet shall contain the following key type controls:

1. Independent and attendant service switches.
2. Light switch.
3. Two speed fan switch.
4. 110V GFCI duplex receptacle.
5. Out-of-service key switch.
6. Emergency stop switch.

Fire Service Cabinet:

1. With instructions engraved on back of door.
2. The cabinet shall include:
3. Call cancel button.

4. Door open button/door close button.
5. Fire Operation key switch.
6. Stop Switch.
7. Additional visual signal.

Emergency communication system: Provide system that complies with ASME A17.1, "Americans with Disabilities Act (ADA), accessibility guidelines for buildings and facilities (ADAAG)." on activation, system dials preprogrammed number of monitoring station and identifies elevator location to monitoring station. System provides two-way voice communication without using a handset and provides visible signals that indicate when system has been activated and when monitoring station has responded. System is contained in flush-mounted cabinet, with identification, instructions for use, and battery backup power supply.

Car position indicator: A vandal resistant car position indicator shall be provided integral with the car operating panel. Illuminated, digital-type car position indicator shall be located above car door or above car control station. Also provide audible signal to indicate to passengers that car is either stopping at or passing each of the floors served.

Hall push-button stations:

1. Hall fixtures shall be provided with necessary push buttons and key switches for elevator operation.
2. Hall fixtures shall be surface mounted and integral hall fixtures shall feature round stainless-steel mechanical buttons marked to correspond to the landings.
3. Include firefighter key switch and designations in the hall station at the designated landing.

Hall lanterns:

1. Manufacturer's wall-mounted units mounted above the entrance frames at all floors.
2. Hall lanterns shall provide a visual indication of the travel direction of the elevator by means of a directional arrow mounted in the hallway above each hoistway door. The hall lanterns shall be mounted such that the centerline of the arrows is a minimum of 72" above the finished floor.

Hall annunciator: With each hall lantern, provide audible signals indicating car arrival and direction of travel. Signals sound once for up and twice for down.

Corridor call station pictograph signs:

1. Provide signs matching hall push-button stations, with text and graphics as required by authorities having jurisdiction, indicating that in case of fire elevators are out of service and exits should be used instead.
2. Provide one sign at each hall push-button station, unless otherwise indicated.

Simplex selective collective operation:

1. Provide simplex selective collective operation from a riser of hall push button stations.
2. The registration of one or more car calls shall dispatch the car to the designated floors in the order in which the floors are reached by the car, irrespective of the sequence in which the calls were registered. The car shall also respond to registered hall calls in the same direction of travel. Car and hall calls shall be canceled when answered.
3. When the car has responded to the highest or lowest call, and calls are registered for the opposite direction, the car shall reverse direction automatically and respond to those registered calls.
4. When the car arrives at its last stop and reverses direction of travel, all previously registered car calls shall be automatically cancelled.
5. When an empty car reverses direction at a landing with no hall calls, doors shall not open and hall lantern shall not operate.

6. The car shall maintain its original direction at each stop until the doors are fully closed to permit a passenger to register a car call before the car reverses its direction of travel.
7. Anti- nuisance feature: in the event car loading or operation is not commensurate with the number of car calls registered, all car calls shall be canceled.

Emergency Control for Fire Department Use: Provide Phase I and Phase II firefighter operation according to A17.1 requirements and local authorities.

B.3.13 Finish Materials

General: Provide the following materials for exposed parts of elevator car enclosures, car doors, hoistway entrance doors and frames, and signal equipment as indicated.

Cold-rolled steel sheet: ASTM A 1008/A 1008M, commercial steel, type B, exposed, matte finish.

Hot-rolled steel sheet: ASTM A 1011/A 1011M, commercial steel, type B, pickled. Stainless-steel sheet: ASTM A 240/A 240M, type 304.

Textured stainless-steel sheet: Product with embossed texture rolled into exposed surface.

Stainless-steel tubing: ASTM A 554, grade MT 304.

Aluminum extrusions: ASTM B 221 (ASTM B 221M), alloy 6063.

Nickel silver extrusions: ASTM B 151/B 151M, alloy UNC No. C74500

B.3.14 Emergency Power Operation

Arrange elevators 01-04 to automatically return nonstop to a designated floor at full speed on emergency power. Bypass any elevator that fails to operate within a pre-determined time. After all cars return to the designated floor and park with their doors open, make a second attempt to automatically return any cars that were bypassed.

Coordinate the automatic sequential lowering operation of the elevators with the electrical engineer.

Provide manual selector switches in the lobby hall station panel located in the first floor to override the automatic operation. Provide an LED indicator light adjacent to the manual selection switches to easily identify which elevators are selected to run under emergency power.

When normal power is restored to the building, the elevators operating on emergency power shall stop at the next available floor and be automatically removed from service. Emergency power shall then be disconnected, and normal power shall be applied to the elevators automatically.

Initiation of normal to emergency and emergency to normal power transfers shall be from transfer switch sensing circuit. The sensing circuit will be a dry contact and will be brought into the machine room. The elevator contractor shall interconnect and interlock all elevators to this sensing circuit.

An emergency power transfer signal generated from a particular automatic transfer switch (ats) shall affect only the elevator bank related to that ats.

Make provisions to operate all car lights on emergency power through a trickle charged emergency power nicad battery operation.

Provide a separate uninterruptible power supply (UPS) battery backup system for the elevator management information system to provide for uninterrupted monitoring and control of the elevators during loss of normal power. The system shall be designed so that it will be unnecessary to "re-boot" the elevator systems during a normal power loss condition.

B.3.15 Auto Battery Lowering (Not applicable)

B.3.16 Control Equipment and Features

Controller:

1. The elevators shall have Non-proprietary PLC-based controller. The controller shall be designed to control the acceleration, deceleration and stopping of the elevators and to prevent damage to the motor from overload or over current condition. Arrange controls to prevent the operation of the elevator in case of phase reversal, phase failure or low voltage in the power supply.

2. The controller shall be mounted in a vented cabinet within the machine room.
3. The controller shall utilize soft start characteristics.
4. The controller shall be designed to operate automatically on standby power.
5. Safety devices shall be provided according to the edition in effect of ASME A17.1 and any local jurisdictional requirements.
6. The controller shall be housed in a NEMA 4X enclosure with a self-supporting steel frame. Provide hinged doors to facilitate service. Within each enclosure provide a locally controlled fluorescent light and a duplex GFCI receptacle.
7. Mount equipment to moisture-resistant, noncombustible panels. Support these panels from steel frame.
8. Provide "noise filter" between hoistway wiring and controller/dispatchers to eliminate interference.

Elevator Drive System:

Variable Voltage Variable Frequency (VVVF) Motor Drive: provide new non-proprietary motor drives as follows:

9. The drive shall be capable of varying the torque on the motor during acceleration and deceleration.
10. The drive shall be capable of on-site programming the volts per Hertz, acceleration and deceleration ride profiles to adjust the ride quality due to drive control characteristics.
11. The flux vector drive shall control AC induction motors through the use of a high resolution, dual channel optical encoder.
12. The flux vector drive shall be capable of delivering 100% rated motor torque from base speed down to zero speed.
13. The flux vector drive shall not use DC injection for slowdown braking.
14. The flux vector drive shall be adjustable to achieve the required current, motor voltage and frequency so as to match the characteristics of the hoist motor.
15. The drive shall not create excessive audible noise in the elevator motor.
16. The drive shall be capable of delivering sufficient current to accelerate the elevators to contract speed at the rated load. The drive shall provide speed regulation within 5% during all phases of acceleration, deceleration and leveling.
17. A contactor shall disconnect the hoist motor from the drive's output each time the elevator stops. If the contactor has not returned to the de-energized state when the elevator stops, the elevator shall not restart.
18. Maximum total harmonic distortion shall not exceed IEEE Std. 519 to be measured at the elevator disconnect.

B.3.17 Wiring - Conduit, Wire, Cable and Conductors

Conduits:

1. Unless otherwise specified, all electrical conductors in the pits and hoistways, except traveling cable connections to the car shall be provided in rigid steel conduit with steel outlet boxes, except that a small amount of flexible conduit may be used where conduit is not subject to moisture or embedded in concrete.
2. Rigid steel conduit shall be full weight, threaded, hot-dip galvanized, inside enameled, conforming to ANSI C80.1.
3. Conduit fittings and bodies shall meet ANSI/NEMA FB 1; threaded type, material to match conduit.
4. Terminal boxes, pull boxes and other similar items, shall be of approved construction, thoroughly reinforced, and shall meet ANSI/NEMA FB 1.

5. All electrical boxes exceeding 150 cubic inches shall be supported independently of the conduits.
6. All raceways shall be threaded rigid steel conduit complying with ANSI/NEMA FB 1.
7. Where permitted flexible heavy-duty service cord, type SO, may be used between fixed car wiring and switches on car doors for safety edges and light ray devices for reversal devices.
8. Where permitted, flexible metal conduit shall be fabricated in continuous length from galvanized steel strip, spirally wound and formed to provide an interlocking design with a gray XLPO Thermoset Type 2 outerjacket.
9. All conduit terminating in steel cabinets, junction boxes, wireways, switch boxes, outlet boxes and similar locations shall have approved insulation bushings. If the bushings are constructed completely of insulation material, a steel locknut shall be installed under the bushing. At ends of conduits not terminating in steel cabinets or boxes, the conductors shall be protected by terminal fittings having an insulated opening for the conductors.
10. All conduits terminating in NEMA 4X boxes shall be backed up with flat rust resistant steel plates to fit the entire area where the conduit penetrated the box.
11. All conduit fittings and connections shall be compression type. The use of set screw or indentations as a means of attachment is not permitted.
12. Connect motors and other components subject to movement or vibration, to the conduit systems with flexible conduit.
13. The contractor shall furnish all materials and completely wire all parts of the electrical equipment of the elevators including electrical devices on hatch doors. All car wiring and conduit shall be replaced with new including car junction boxes.
14. All solid state and electrical components located on top of the car enclosure or in the hoistway shall be installed within NEMA 4X enclosures.
15. Conduits shall be brought and connected to suitable approved connection boxes at all outlets, apparatus and panels.

Conductors:

1. Unless otherwise specified, conductors, exclusive of traveling cables, shall be 98% conductivity copper, solid, for size 10 AWG and smaller, and stranded for size 8 AWG and larger shall be stranded or solid coated annealed copper according to the NEC for Type THHW.
2. Where 16 and 18 AWG are permitted by Code, either single conductor cable according to Code for Type TF, or multiple conductor cable may be used provided the insulation of single conductor cable and outer jacket of multiple conductor cable is flame retardant and moisture resistant.
3. Insulation Voltage Rating: 600 volts.
4. Insulation: ANSI/NFPA 70, type THHN/THWN, XHHW or THW.
5. The use of PVC insulation shall not be permitted.
6. For wire sizes No. 8 AWG and larger, color banding tape, minimum 2 inches wide, may be used at all accessible locations in lieu of colored insulation.
7. Multiple conductor cable shall have color coding or other suitable identification for each conductor. Conductors for control boards shall be according to Code.
8. No joints or splices shall be permitted in wiring except at outlets. Tap connectors may be used in wireways provided they meet all UL requirements.
9. All wiring shall test free from short circuits or grounds. Insulation resistance between individual external conductors and between conductors and ground shall be not less than one meg-ohm.
10. Where size of conductors is not given, capacity shall be such that maximum current shall not exceed limits prescribed by Code.

11. Equipment grounding shall be furnished and installed. Ground conduits, supports, controller enclosures, motors, platform and car frames, and all other non-current conducting metal enclosures for electrical equipment according to Code. The ground wires shall be copper, green, insulated and sized as required.
12. Terminal connections for all conductors used for external wiring between various items of elevator equipment shall be solderless pressure wire connectors according to Code. The contractor may at his option make these terminal connections on No. 10 or smaller conductors with approved terminal eyelets set on the conductor with a special setting tool, or with an approved pressure type terminal block. Terminal blocks using pierce-through serrated washers are not acceptable.
13. Provide all necessary conduit and wiring between all remote machine room and hoistway.

Traveling Cables:

1. Traveling cables from junction box on car to junction box in hoistway shall consist of flexible traveling cables conforming to the requirements of Code.
2. Junction boxes in hoistway and on car shall be equipped with terminal blocks. All connections to terminal blocks shall be made with either terminal eyelet connections or pressure wire connectors of the clamp type that meet UL 486 requirements for stranded wire.
3. Terminal blocks shall have permanent indelible identifying numbers for each connection. The outer covering must remain intact between junction boxes. Abrupt bending or twisting producing distortion of cable is not permitted.
4. Cables shall be free from any possible contact with hoistway structure, car or other equipment. Furnish and install shields or pads to protect the cables.
5. Travel cables shall include, as a minimum: 2 coaxial cables shielded for the CCTV system. 4 cat 5 twisted shielded pairs for security and telephone systems
6. Provide separate traveling cables for car lighting and fan control circuits.
7. Provide traveling cable for telephone in the elevator car. Cable shall extend from junction box in hoistway to telephone box in car.
8. Provide traveling cable for car work lights. Cable shall extend from junction box in hoistway to car junction box.
9. Car and hoistway junction boxes shall be provided for on the top of the elevator cab.
10. Cables shall include ten percent spare wires between each controller, selector, and hoistway junction box, all spares to be properly tagged or otherwise identified with clear and indelible markings.
11. All insulated wiring, control wiring and wiring in traveling cables shall be tag coded at their terminals in the motor room, and hoistway junction box, elevator cab junction box, and push-button stations within the cab, and shall agree with the approved wiring diagrams.
12. The traveling cable shall be wired directly from the controller to the elevator with no hoistway junction box.
13. The emergency stop switch in the car shall be connected to all alarm bells in a manner that will cause the bells to ring when the emergency stop switch is in the "On" position.
14. Traveling cables shall be flame and moisture-resistant outer cover.

Wiring: Wiring on the units, whether factory or field wiring, shall be done in neat order, and all connections shall be made to studs and/or terminals by means of grommets, solderless lugs or similar connections. All wiring shall be copper.

Marking: Identifying symbols or letters shall be permanently marked on or adjacent to each device on the unit, and the marking shall be identical with marking used on the wiring diagrams. In addition to the identifying marks, the ampere rating shall be marked adjacent to all fuse holders.

C Construction

C.1 Examination

Examine elevator areas, with installer present, for compliance with requirements for installation tolerances and other conditions affecting performance. Examine hoistways, hoistway openings, pits, and machine rooms as constructed; verify critical dimensions; and examine supporting structure and other conditions under which elevator work is to be installed.

For the record, prepare a written report, endorsed by installer, listing dimensional discrepancies and conditions detrimental to performance or indicating that dimensions and conditions were found to be satisfactory.

Proceed with installation only after unsatisfactory conditions have been corrected.

C.2 Installation

Comply with manufacturer's written instructions.

Welded construction: provide welded connections for installing elevator work where bolted connections are not required for subsequent removal or for normal operation, adjustment, inspection, maintenance, and replacement of worn parts. Comply with AWS standards for workmanship and for qualifications of welding operators.

Sound isolation: mount rotating and vibrating equipment on vibration-isolating mounts designed to minimize transmission of vibrations to structures and thereby minimize structure-borne noise from elevator system.

Lubricate operating parts of systems, including ropes, as recommended by manufacturers.

Alignment: coordinate installation of hoistway entrances with installation of elevator guide rails for accurate alignment of entrances with car. Where possible, delay final adjustment of sills and doors until car is operable in shaft. Reduce clearances to minimum, safe, workable dimension at each landing.

Leveling tolerance: 1/8 inch, up or down, regardless of load and direction of travel.

Set sills flush with finished floor surface at landing. Fill space under sill solidly with nonshrink, nonmetallic grout.

Locate hall signal equipment for elevators as follows, unless otherwise indicated:

1. Locate hall push-button stations at a minimum of 42 inches above finished floor.
2. Place hall lanterns above each hoistway entrance.

C.3 Field Quality Control

Acceptance testing: On completion of elevators installation and before permitting use (either temporary or permanent) of elevators, perform acceptance tests as required and recommended by ASME A17.1 and by governing regulations and agencies.

Advise authority, engineer, and authorities having jurisdiction in advance of dates and times tests are to be performed on elevators.

C.4 Protection

Temporary use: Limit temporary use for construction purposes to one elevator. Comply with the following requirements for each elevator used for construction purposes:

1. Provide car with temporary enclosure, either within finished car or in place of finished car, to protect finishes from damage.
2. Provide strippable protective film on entrance and car doors and frames.
3. Provide padded wood bumpers on entrance door frames covering jambs and frame faces.
4. Provide other protective coverings, barriers, devices, signs, and procedures as needed to protect elevator and elevator equipment.
5. Do not load elevators beyond their rated weight capacity.

6. Engage elevator installer to provide full maintenance service. Include preventive maintenance, repair or replacement of worn or defective components, lubrication, cleaning, and adjusting as necessary for proper elevator operation at rated speed and capacity. Provide parts and supplies same as those used in the manufacture and installation of original equipment.
7. Engage elevator installer to restore damaged work, if any, so no evidence remains of correction. Return items that cannot be refinished in the field to the shop, make required repairs and refinish entire unit, or provide new units as required.

C.5 Demonstration

Engage a factory-authorized service representative to train authority’s maintenance personnel to operate elevator.

Check operation of each elevator with authority’s personnel present and before date of substantial completion. Determine that operation systems and devices are functioning properly.

D Measurement

The department will measure Traction Elevators as a single unit for each, acceptably completed.

E Payment

The department will pay for measured quantities at the contract unit price under the following bid item:

ITEM NUMBER	DESCRIPTION	UNIT
SPV.0060.06	Traction Elevators	EACH

Payment is full compensation for furnishing all labor, tools, equipment, materials, and incidentals necessary to complete the contract work.

29. Doors and Door Hardware, Item SPV.0060.07.

A Description

A.1 SUMMARY

A.1.1 Section includes:

1. Mechanical and electrified door hardware
2. Electronic access control system components

A.1.2 Section excludes:

1. Windows
2. Cabinets (casework), including locks in cabinets
3. Signage
4. Toilet accessories
5. Overhead doors

A.1.3 Related Sections:

1. Section "Rough Carpentry"
2. Section "Finish Carpentry"
3. Section "Joint Sealants" for sealant requirements applicable to threshold installation specified in this section.
4. Sections:
5. "Metal Doors and Frames"

6. "Aluminum-Framed Entrances and Storefronts"
7. "Stainless Steel Doors and Frames"
8. sections for touchup, finishing or refinishing of existing openings modified by this section.
9. "Electrical" sections for connections to electrical power system and for low-voltage wiring.
10. "Electronic Safety and Security" sections for coordination with other components of electronic access control system and fire alarm system.

A.2 REFERENCES

A.2.1 UL LLC

1. UL 10C - Positive Pressure Test of Fire Door Assemblies
2. UL 1784 - Air Leakage Tests of Door Assemblies
3. UL 305 - Panic Hardware

A.2.2 DHI - Door and Hardware Institute

1. Sequence and Format for the Hardware Schedule
2. Recommended Locations for Builders Hardware
3. Keying Systems and Nomenclature
4. Installation Guide for Doors and Hardware

A.2.3 NFPA – National Fire Protection Association

1. NFPA 70 – National Electric Code
2. NFPA 80 – 2016 Edition – Standard for Fire Doors and Other Opening Protectives
3. NFPA 101 – Life Safety Code
4. NFPA 105 – Smoke and Draft Control Door Assemblies
5. NFPA 252 – Fire Tests of Door Assemblies

A.2.4 ANSI - American National Standards Institute

1. ANSI A117.1 – 2017 Edition – Accessible and Usable Buildings and Facilities
2. ANSI/BHMA A156.1 - A156.29, and ANSI/BHMA A156.31 - Standards for Hardware and Specialties
3. ANSI/BHMA A156.28 - Recommended Practices for Keying Systems
4. ANSI/WDMA I.S. 1A - Interior Architectural Wood Flush Doors
5. ANSI/SDI A250.8 - Standard Steel Doors and Frames

A.3 SUBMITTALS

A.3.1 General:

1. Submit according to Conditions of Contract.
2. Prior to forwarding submittal:
 - a. Comply with procedures for verifying existing door and frame compatibility for new hardware, as specified in PART 3, "EXAMINATION" article, herein.
 - b. Review drawings and Sections from related trades to verify compatibility with specified hardware.
 - c. Highlight, encircle, or otherwise specifically identify on submittals: deviations from Contract Documents, issues of incompatibility or other issues which may detrimentally affect the Work.

A.3.2 Action Submittals:

1. **Product Data:** Submit technical product data for each item of door hardware, installation instructions, maintenance of operating parts and finish, and other information necessary to show compliance with requirements.
2. **Riser and Wiring Diagrams:** After final approval of hardware schedule, submit details of electrified door hardware, indicating:
 - a. **Wiring Diagrams:** For power, signal, and control wiring and including:
 - i Details of interface of electrified door hardware and building safety and security systems.
 - ii Schematic diagram of systems that interface with electrified door hardware.
 - iii Point-to-point wiring.
 - iv Risers.
3. **Samples for Verification:** If requested by Architect, submit production sample of requested door hardware unit in finish indicated and tagged with full description for coordination with schedule.
 - a. Samples will be returned to supplier. Units that are acceptable to Architect may, after final check of operations, be incorporated into Work, within limitations of key coordination requirements.
4. **Door Hardware Schedule:**
 - a. Submit concurrent with submissions of Product Data, Samples, and Shop Drawings. Coordinate submission of door hardware schedule with scheduling requirements of other work to facilitate fabrication of other work critical in Project construction schedule.
 - b. Submit under direct supervision of a Door Hardware Institute (DHI) certified Architectural Hardware Consultant (AHC) or Door Hardware Consultant (DHC) with hardware sets in vertical format as illustrated by Sequence of Format for the Hardware Schedule published by DHI.
 - c. Indicate complete designations of each item required for each opening, include:
 - i Door Index: door number, heading number, and Architect's hardware set number.
 - ii Quantity, type, style, function, size, and finish of each hardware item.
 - iii Name and manufacturer of each item.
 - iv Fastenings and other pertinent information.
 - v Location of each hardware set cross-referenced to indications on Drawings.
 - vi Explanation of all abbreviations, symbols, and codes contained in schedule.
 - vii Mounting locations for hardware.
 - viii Door and frame sizes and materials.
 - ix Degree of door swing and handing.
 - x Operational Description of openings with electrified hardware covering egress, ingress (access), and fire/smoke alarm connections.
5. **Key Schedule:**
 - a. After Keying Conference, provide keying schedule that includes levels of keying, explanations of key system's function, key symbols used, and door numbers controlled.
 - b. Use ANSI/BHMA A156.28 "Recommended Practices for Keying Systems" as guideline for nomenclature, definitions, and approach for selecting optimal keying system.
 - c. Provide 3 copies of keying schedule for review prepared and detailed according to referenced DHI publication. Include schematic keying diagram and index each key to unique door designations.

- d. Index keying schedule by door number, keyset, hardware heading number, cross keying instructions, and special key stamping instructions.
- e. Provide one complete bitting list of key cuts and one key system schematic illustrating system usage and expansion. Forward bitting list, key cuts and key system schematic directly to Owner, by means as directed by Owner.
- f. Prepare key schedule by or under supervision of supplier, detailing Owner's final keying instructions for locks.

A.3.3 Informational Submittals:

- 1. Provide Qualification Data for Supplier, Installer and Architectural Hardware Consultant.
- 2. Provide Product Data:
 - a. Certify that door hardware approved for use on types and sizes of labeled fire-rated doors complies with listed fire-rated door assemblies.
 - b. Include warranties for specified door hardware.

A.3.4 Closeout Submittals:

- 1. Operations and Maintenance Data: Provide and include:
 - a. Complete information on care, maintenance, and adjustment; data on repair and replacement parts, and information on preservation of finishes.
 - b. Catalog pages for each product.
 - c. Final approved hardware schedule edited to reflect conditions as installed.
 - d. Final keying schedule
 - e. Copy of warranties including appropriate reference numbers for manufacturers to identify project.
 - f. As-installed wiring diagrams for each opening connected to power, both low voltage and 110 volts.

A.3.5 Inspection and Testing:

- 1. Submit written reports to the Owner and Authority Having Jurisdiction (AHJ) of the results of functional testing and inspection for:
 - a. Fire door assemblies, in compliance with NFPA 80.
 - b. Required egress door assemblies, in compliance with NFPA 101.

A.4 QUALITY ASSURANCE

A.4.1 Qualifications and Responsibilities:

- 1. Supplier: Recognized architectural hardware supplier with a minimum of 5 years documented experience supplying both mechanical and electromechanical door hardware similar in quantity, type, and quality to that indicated for this Project. Supplier to be recognized as a factory direct distributor by the manufacturer of the primary materials with a warehousing facility in the Project's vicinity. Supplier to have on staff, a certified Architectural Hardware Consultant (AHC) or Door Hardware Consultant (DHC) available to owner, architect, and contractor, at reasonable times during the Work for consultation.
- 2. Installer: Qualified tradesperson skilled in the application of commercial grade hardware with experience installing door hardware similar in quantity, type, and quality as indicated for this Project.
- 3. Architectural Hardware Consultant: Person who is experienced in providing consulting services for door hardware installations that are comparable in material, design, and extent to that indicated for this Project and meets these requirements:

- a. For door hardware: DHI certified AHC or DHC.
 - b. Can provide installation and technical data to Architect and other related subcontractors.
 - c. Can inspect and verify components are in working order upon completion of installation.
 - d. Capable of producing wiring diagram and coordinating installation of electrified hardware with Architect and electrical engineers.
4. Single Source Responsibility: Obtain each type of door hardware from single manufacturer.

A.4.2 Certifications:

- 1. Fire-Rated Door Openings:
 - a. Provide door hardware for fire-rated openings that complies with NFPA 80 and requirements of authorities having jurisdiction.
 - b. Provide only items of door hardware that are listed products tested by UL LLC, Intertek Testing Services, or other testing and inspecting organizations acceptable to authorities having jurisdiction for use on types and sizes of doors indicated, based on testing at positive pressure and according to NFPA 252 or UL 10C and in compliance with requirements of fire-rated door and door frame labels.
- 2. Smoke and Draft Control Door Assemblies:
 - a. Provide door hardware that meets requirements of assemblies tested according to UL 1784 and installed in compliance with NFPA 105
 - b. Comply with the maximum air leakage of 0.3 cfm/sq. ft. (3 cu. m per minute/sq. m) at tested pressure differential of 0.3-inch wg (75 Pa) of water.
- 3. Electrified Door Hardware
 - a. Listed and labeled as defined in NFPA 70, Article 100, by testing agency acceptable to authorities having jurisdiction.

A.4.3 Accessibility Requirements:

- a. Comply with governing accessibility regulations cited in "REFERENCES" article 087100, 1.02.D3 herein for door hardware on doors in an accessible route. This project must comply with all Federal Americans with Disability Act regulations and all Local Accessibility Regulations.

A.4.4 Pre-Installation Meetings

- 1. Keying Conference
 - a. Incorporate keying conference decisions into final keying schedule after reviewing door hardware keying system including:
- 2. Function of building, flow of traffic, purpose of each area, degree of security required, and plans for future expansion.
- 3. Preliminary key system schematic diagram.
- 4. Requirements for key control system.
- 5. Requirements for access control.
- 6. Address for delivery of keys.
- 7. Pre-installation Conference
 - a. Review and finalize construction schedule and verify availability of materials, Installer's personnel, equipment, and facilities needed to make progress and avoid delays.
 - b. Inspect and discuss preparatory work performed by other trades.
 - c. Inspect and discuss electrical roughing-in for electrified door hardware.
 - d. Review sequence of operation for each type of electrified door hardware.

- e. Review required testing, inspecting, and certifying procedures.
 - f. Review questions or concerns related to proper installation and adjustment of door hardware.
8. Electrified Hardware Coordination Conference:
- a. Prior to ordering electrified hardware, schedule and hold meeting to coordinate door hardware with security, electrical, doors and frames, and other related suppliers.

A.5 DELIVERY, STORAGE, AND HANDLING

1. Inventory door hardware on receipt and provide secure lock-up for hardware delivered to Project site. Promptly replace products damaged during shipping.
2. Tag each item or package separately with identification coordinated with final door hardware schedule, and include installation instructions, templates, and necessary fasteners with each item or package. Deliver each article of hardware in manufacturer's original packaging.
3. Maintain manufacturer-recommended environmental conditions throughout storage and installation periods.
4. Provide secure lock-up for door hardware delivered to Project. Control handling and installation of hardware items so that completion of Work will not be delayed by hardware losses both before and after installation.
5. Handle hardware in manner to avoid damage, marring, or scratching. Correct, replace or repair products damaged during Work. Protect products against malfunction due to paint, solvent, cleanser, or any chemical agent.
6. Deliver keys to manufacturer of key control system for subsequent delivery to Owner.

A.6 COORDINATION

1. Coordinate layout and installation of floor-recessed door hardware with floor construction. Cast anchoring inserts into concrete.
2. Installation Templates: Distribute for doors, frames, and other work specified to be factory or shop prepared. Check Shop Drawings of other work to confirm that adequate provisions are made for locating and installing door hardware to comply with indicated requirements.
3. Security: Coordinate installation of door hardware, keying, and access control with Owner's security consultant.
4. Electrical System Roughing-In: Coordinate layout and installation of electrified door hardware with connections to power supplies and building safety and security systems.
5. Existing Openings: Where existing doors, frames and/or hardware are to remain, field verify existing functions, conditions and preparations and coordinate to suit opening conditions and to provide proper door operation.

A.7 WARRANTY

A.7.1 Manufacturer's standard form in which manufacturer agrees to repair or replace components of door hardware that fail in materials or workmanship within published warranty period.

1. Warranty does not cover damage or faulty operation due to improper installation, improper use or abuse.
2. Warranty Period: Beginning from date of Substantial Completion, for durations indicated in manufacturer's published listings.
 - a. Mechanical Warranty
 - i Locks
 - 8) Schlage L Series: 3 years
 - ii Exit Devices
 - 9) Von Duprin: 3 years

- iii Closers
 - 10) LCN 4000 Series: 30 years
- iv Automatic Operators
 - 11) LCN: 2 years
- b. Electrical Warranty
 - i Exit Devices
 - 12) Von Duprin: 1 year
 - ii Closers
 - 13) LCN: 2 years

A.8 MAINTENANCE

- A.8.1** Furnish complete set of special tools required for maintenance and adjustment of hardware, including changing of cylinders.
- A.8.2** Turn over unused materials to Owner for maintenance purposes.

B Manufacturers

B.1 MANUFACTURERS

1. The Owner requires use of certain products for their unique characteristics and project suitability to ensure continuity of existing and future performance and maintenance standards. After investigating available product offerings, the Awarding Authority has elected to prepare proprietary specifications. These products are specified with the notation: "Owner's Standard."
 - a. Where "Owner's Standard" is noted, submittals and substitution requests for other products will not be considered.
2. Approval of manufacturers and/or products other than those listed as "Scheduled Manufacturer" or "Acceptable Manufacturers" in the individual article for the product category shall be according to QUALITY ASSURANCE article, herein.
3. Approval of products from manufacturers indicated in "Acceptable Manufacturers" is contingent upon those products providing all functions and features and meeting all requirements of scheduled manufacturer's product.

B.2 MATERIALS

B.2.1 Fabrication

1. Provide door hardware manufactured to comply with published templates generally prepared for machine, wood, and sheet metal screws. provide screws according to manufacturer's recognized installation standards for application intended.
2. Finish exposed screws to match hardware finish, or, if exposed in surfaces of other work, to match finish of this other work including prepared for paint surfaces to receive painted finish.
3. Provide concealed fasteners wherever possible for hardware units exposed when door is closed. Coordinate with "Metal Doors and Frames", "Flush Wood Doors", "Stile and Rail Wood Doors" to ensure proper reinforcements. Advise the Architect where visible fasteners, such as through bolts, are required.

B.2.2 Provide screws, bolts, expansion shields, drop plates and other devices necessary for hardware installation.

1. Where fasteners are exposed to view: Finish to match adjacent door hardware material.

B.3 HINGES

B.3.1 Manufacturers and Products:

1. Scheduled Manufacturer and Product:
 - a. Ives 5BB series
2. Acceptable Manufacturers and Products:
 - a. Hager BB1191/1279 series
 - b. Stanley FBB series

B.3.2 Requirements:

1. Provide hinges conforming to ANSI/BHMA A156.1.
2. Provide five knuckle, ball bearing hinges.
3. 1-3/4 inch (44 mm) thick doors, up to and including 36 inches (914 mm) wide:
 - a. Exterior: Standard weight, bronze or stainless steel, 4-1/2 inches (114 mm) high
 - b. Interior: Standard weight, steel, 4-1/2 inches (114 mm) high
4. 1-3/4 inch (44 mm) thick doors over 36 inches (914 mm) wide:
 - a. Exterior: Heavy weight, bronze/stainless steel, 5 inches (127 mm) high
 - b. Interior: Heavy weight, steel, 5 inches (127 mm) high
5. 2 inches or thicker doors:
 - a. Exterior: Heavy weight, bronze or stainless steel, 5 inches (127 mm) high
 - b. Interior: Heavy weight, steel, 5 inches (127 mm) high
6. Adjust hinge width for door, frame, and wall conditions to allow proper degree of opening.
7. Provide three hinges per door leaf for doors 90 inches (2286 mm) or less in height, and one additional hinge for each 30 inches (762 mm) of additional door height.
8. Where new hinges are specified for existing doors or existing frames, provide new hinges of identical size to hinge preparation present in existing door or existing frame.
9. Hinge Pins: Except as otherwise indicated, provide hinge pins as follows:
 - a. Steel Hinges: Steel pins
 - b. Non-Ferrous Hinges: Stainless steel pins
 - c. Out-Swinging Exterior Doors: Non-removable pins
 - d. Out-Swinging Interior Lockable Doors: Non-removable pins
 - e. Interior Non-lockable Doors: Non-rising pins
10. Provide hinges with electrified options as scheduled in the hardware sets. Provide with number and gage of wires enough to accommodate electric function of specified hardware. Locate electric hinge at second hinge from bottom or nearest to electrified locking component. Provide mortar guard for each electrified hinge specified.

B.4 CONTINUOUS HINGES

B.4.1 Manufacturers:

1. Scheduled Manufacturer:
 - a. Ives
2. Acceptable Manufacturers:
 - a. Select

B.4.2 Requirements:

1. Provide aluminum geared continuous hinges conforming to ANSI/BHMA A156.26, Grade 1.
2. Provide aluminum geared continuous hinges, where specified in the hardware sets, fabricated from 6063-T6 aluminum.
3. Provide split nylon bearings at each hinge knuckle for quiet, smooth, self-lubricating operation.
4. Provide hinges capable of supporting door weights up to 450 pounds, and successfully tested for 1,500,000 cycles.
5. On fire-rated doors, provide aluminum geared continuous hinges classified for use on rated doors by testing agency acceptable to authority having jurisdiction.
6. Provide aluminum geared continuous hinges with electrified option scheduled in the hardware sets. Provide with number and gage of wires enough to accommodate electric function of specified hardware.
7. Provide hinges 1 inch (25 mm) shorter in length than nominal height of door, unless otherwise noted or door details require shorter length and with symmetrical hole pattern.

B.5 ELECTRIC POWER TRANSFER

B.5.1 Manufacturers:

1. Scheduled Manufacturer and Product:
 - a. Von Duprin EPT-10
2. Acceptable Manufacturers and Products:
 - a. Owner's Standard

B.5.2 Requirements:

1. Provide power transfer with electrified options as scheduled in the hardware sets. Provide with number and gage of wires enough to accommodate electric function of specified hardware.
2. Locate electric power transfer per manufacturer's template and UL requirements, unless interference with operation of door or other hardware items.

B.6 FLUSH BOLTS

B.6.1 Manufacturers:

B.6.1.1 Scheduled Manufacturer:

1. Ives

B.6.1.2 Acceptable Manufacturers:

1. Burns
2. DCI
3. Trimco

B.6.2 Requirements:

1. Provide automatic, constant latching, and manual flush bolts with forged bronze or stainless-steel face plates, extruded brass levers, and with wrought brass guides and strikes. Provide 12 inch (305 mm) steel or brass rods at doors up to 90 inches (2286 mm) in height. For doors over 90 inches (2286 mm) in height increase top rods by 6 inches (152 mm) for each additional 6 inches (152 mm) of door height. Provide dust-proof strikes at each bottom flush bolt.

B.7 MORTISE LOCKS

B.7.1 Manufacturers and Products:

1. Scheduled Manufacturer and Product:
 - a. Schlage L9000 series

2. Acceptable Manufacturers and Products:

- a. Sargent 8200 series
- b. Best 45H series

B.7.2 Requirements:

1. Provide mortise locks conforming to ANSI/BHMA A156.13 Series 1000, Grade 1, and UL Listed for 3-hour fire doors.
2. Indicators: Where specified, provide indicator window measuring a minimum 2-inch x 1/2 inch with 180-degree visibility. Provide messages color-coded with full text and/or symbols, as scheduled, for easy visibility.
3. Provide locks manufactured from heavy gauge steel, containing components of steel with a zinc dichromate plating for corrosion resistance.
4. Provide lock case that is multi-function and field reversible for handing without opening case. Cylinders: Refer to "KEYING" article, herein.
5. Provide locks with standard 2-3/4 inches (70 mm) backset with full 3/4 inch (19 mm) throw stainless steel mechanical anti-friction latchbolt. Provide deadbolt with full 1-inch (25 mm) throw, constructed of stainless steel.
6. Provide standard ASA strikes unless extended lip strikes are necessary to protect trim. Provide electrified options as scheduled in the hardware sets. Where scheduled, provide switches and sensors integrated into the locks and latches.
7. Provide motor based electrified locksets that comply with the following requirements:
 - a. Universal input voltage – single chassis accepts 12 or 24VDC to allow for changes in the field without changing lock chassis.
 - b. Fail Safe/Fail Secure – changing mode between electrically locked (fail safe) and electrically unlocked (fail secure) is field selectable without opening the lock case.
 - c. Low maximum current draw – maximum 0.4 amps to allow for multiple locks on a single power supply.
 - d. Low holding current – maximum 0.01 amps to produce minimal heat, eliminate “hot levers” in electrically locked applications, and to provide reliable operation in wood doors that provide minimal ventilation and air flow.
 - e. Connections – provide quick-connect Molex system standard.
8. Lever Trim: Solid brass, bronze, or stainless steel, cast or forged in design specified, with wrought roses and external lever spring cages. Provide through-bolted levers with 2-piece spindles.
 - a. Lever Design: 06A

B.8 EXIT DEVICES

B.8.1 Manufacturers and Products:

1. Scheduled Manufacturer and Product:
 - a. Von Duprin 98/35A series
2. Acceptable Manufacturers and Products:
 - a. Owner's Standard

B.8.2 Requirements:

1. Provide exit devices tested to ANSI/BHMA A156.3 Grade 1 and UL listed for Panic Exit or Fire Exit Hardware.
2. Cylinders: Refer to "KEYING" article, herein.

3. Provide smooth touchpad type exit devices, fabricated of brass, bronze, stainless steel, or aluminum, plated to standard architectural finishes to match balance of door hardware.
4. Touchpad must extend a minimum of one half of door width. No plastic inserts are allowed in touchpads.
5. Provide exit devices with deadlatching feature for security and for future addition of alarm kits and/or other electrified requirements.
6. Provide exit devices with weather resistant components that can withstand harsh conditions of various climates and corrosive cleaners used in outdoor pool environments.
7. Provide flush end caps for exit devices.
8. Provide exit devices with manufacturer's approved strikes.
9. Provide exit devices cut to door width and height. Install exit devices at height recommended by exit device manufacturer, allowable by governing building codes, and approved by Architect.
10. Mount mechanism case flush on face of doors or provide spacers to fill gaps behind devices. Where glass trim or molding projects off face of door, provide glass bead kits.
11. Provide cylinder or hex-key dogging as specified at non fire-rated openings.
12. Removable Mullions: 2 inches (51 mm) x 3 inches (76 mm) steel tube. Where scheduled as keyed removable mullion, provide type that can be removed by use of a keyed cylinder, which is self-locking when re-installed.
13. Provide factory drilled weep holes for exit devices used in full exterior application, highly corrosive areas, and where noted in hardware sets.
14. Provide electrified options as scheduled.
15. Top latch mounting: double- or single-tab mount for steel doors, face mount for aluminum doors eliminating requirement of tabs, and double tab mount for wood doors.
16. Provide exit devices with optional trim designs to match other lever and pull designs used on the project.

B.9 KEYSWITCHES

B.9.1 Manufacturers and Products:

1. Scheduled Manufacturer and Product:
 - a. Schlage 650 series
2. Acceptable Manufacturers and Products:
 - a. Security Door Control 700 series

B.9.2 Requirements:

1. Provide key switches capable of being configured to momentary or maintained action.
2. Provide key switches that accept a mortise cylinder. Cylinders: Refer to "KEYING" article, herein.

B.10 POWER SUPPLIES

B.10.1 Manufacturers and Products:

1. Scheduled Manufacturer and Product:
 - a. Schlage/Von Duprin PS900 Series
2. Acceptable Manufacturers and Products:
 - a. Owner's Standard

B.10.2 Requirements:

1. Provide power supplies approved by manufacturer of supplied electrified hardware.
2. Provide appropriate quantity of power supplies necessary for proper operation of electrified locking components as recommended by manufacturer of electrified locking components with consideration for each electrified component using power supply, location of power supply, and approved wiring diagrams. Locate power supplies as directed by Architect.
3. Provide regulated and filtered 24 VDC power supply, and UL class 2 listed.
4. Provide power supplies with the following features:
 - a. 12/24 VDC Output, field selectable.
 - b. Class 2 Rated power limited output.
 - c. Universal 120-240 VAC input.
 - d. Low voltage DC, regulated and filtered.
 - e. Polarized connector for distribution boards.
 - f. Fused primary input.
 - g. AC input and DC output monitoring circuit w/LED indicators.
 - h. Cover mounted AC Input indication.
 - i. Tested and certified to meet UL294.
 - j. NEMA 1 enclosure.
 - k. Hinged cover w/lock down screws.
 - l. High voltage protective cover.

B.11 CYLINDERS

B.11.1 Manufacturers:

1. Scheduled Manufacturer and Product:
 - a. Match owner's existing system.
2. Acceptable Manufacturers and Products:
 - a. No Substitute

B.11.2 Requirements:

1. Provide cylinders/cores to match Owner's existing key system, compliant with ANSI/BHMA A156.5; latest revision; cylinder face finished to match lockset, manufacturer's series as indicated. Refer to "KEYING" article, herein.

B.12 KEY CONTROL SYSTEM

B.12.1 Manufacturers:

1. Scheduled Manufacturer:
 - a. Telkee
2. Acceptable Manufacturers:
 - a. HPC
 - b. Lund

B.12.2 Requirements:

1. Provide key control system, including envelopes, labels, tags with self-locking key clips, receipt forms, 3-way visible card index, temporary markers, permanent markers, and standard metal cabinet, all as recommended by system manufacturer, with capacity for 150% of number of locks required for Project.

- a. Provide complete cross index system set up by hardware supplier, and place keys on markers and hooks in cabinet as determined by final key schedule.
- b. Provide hinged-panel type cabinet for wall mounting.

B.13 DOOR CLOSERS

B.13.1 Manufacturers and Products:

1. Scheduled Manufacturer and Product:
 - a. LCN 4010/4110/4020 series
2. Acceptable Manufacturers and Products:
 - a. Owner's Standard

B.13.2 Requirements:

1. Provide door closers conforming to ANSI/BHMA A156.4 Grade 1 requirements by BHMA certified independent testing laboratory. Certify surface mounted mechanical closers to meet fifteen million (15,000,000) full load cycles. ISO 9000 certify closers. Stamp units with date of manufacture code.
2. Provide door closers with fully hydraulic, full rack and pinion action with high strength cast iron cylinder, and full complement bearings at shaft.
3. Cylinder Body: 1-1/2-inch (38 mm) diameter with 11/16-inch (17 mm) diameter double heat-treated pinion journal.
4. Hydraulic Fluid: Fireproof, passing requirements of UL10C, and requiring no seasonal closer adjustment for temperatures ranging from 120 degrees F to -30 degrees F.
5. Spring Power: Continuously adjustable over full range of closer sizes, and providing reduced opening force as required by accessibility codes and standards.
6. Hydraulic Regulation: By tamper-proof, non-critical valves, with separate adjustment for latch speed, general speed, and backcheck.
7. Provide closers with solid forged steel main arms and factory assembled heavy-duty forged forearms for parallel arm closers. When closers are parallel arm mounted, provide closers which mount within 6-inch (152 mm) top rail without use of mounting plate so that closer is not visible through vision panel from pull side.
8. Pressure Relief Valve (PRV) Technology: Not permitted.
9. Finish for Closer Cylinders, Arms, Adapter Plates, and Metal Covers: Powder coating finish which has been certified to exceed 100 hours salt spray testing as described in ANSI/BHMA Standard A156.4 and ASTM B117, or has special rust inhibitor (SRI).
10. Provide special templates, drop plates, mounting brackets, or adapters for arms as required for details, overhead stops, and other door hardware items interfering with closer mounting.

B.14 ELECTRO-MECHANICAL CLOSER/HOLDERS

B.14.1 Manufacturers:

1. Scheduled Manufacturer:
 - a. LCN
2. Acceptable Manufacturers:
 - a. Owner's Standard

B.14.2 Requirements:

1. Provide single-point or multi-point hold-open electro-mechanical closer/holders as specified. Coordinate voltage requirements and provide transformer if necessary.
2. Provide closer/holders that function as full rack and pinion door closer when current is interrupted or continuous hold-open is not engaged.

3. Provide door closers with fully hydraulic, full rack and pinion action with high strength cylinder and full complement bearings at shaft.
4. Hydraulic Fluid: Fireproof, passing requirements of UL10C, and requiring no seasonal closer adjustment for temperatures ranging from 120 degrees F to -30 degrees F.
5. Spring Power: Continuously adjustable over full range of closer sizes, and providing reduced opening force as required by accessibility codes and standards.
6. Hydraulic Regulation: By tamper-proof, non-critical valves, with separate adjustment for latch speed, general speed, and backcheck.
7. Pressure Relief Valve (PRV) Technology: Not permitted.
8. Provide special templates, drop plates, mounting brackets, or adapters for arms as required for details, overhead stops, and other door hardware items interfering with closer mounting.

B.15 ELECTRO-HYDRAULIC AUTOMATIC OPERATORS

B.15.1 Manufacturers and Products:

1. Scheduled Manufacturer and Product:
 - a. LCN 4600 series
2. Acceptable Manufacturers and Products:
 - a. Owner's Standard

B.15.2 Requirements:

1. Provide low energy automatic operator units with hydraulic closer complying with ANSI/BHMA A156.19.
2. Hydraulic Fluid: Fireproof, passing requirements of UL10C, and requiring no seasonal closer adjustment for temperatures ranging from 120 degrees F to -30 degrees F.
3. Provide units with conventional door closer opening and closing forces unless power operator motor is activated. Provide door closer assembly with adjustable spring size, back-check, and opening and closing speed adjustment valves to control door
4. Provide units with on/off switch for manual operation, motor start up delay, vestibule interface delay, electric lock delay, and door hold open delay.
5. Provide drop plates, brackets, and adapters for arms as required for details.
6. Provide actuator switches and receivers for operation as specified.
7. Provide weather-resistant actuators at exterior applications.
8. Provide key switches with LED's, recommended and approved by manufacturer of automatic operator as required for function described in operation description of hardware group below. Cylinders: Refer to "KEYING" article, herein.
9. Provide complete assemblies of controls, switches, power supplies, relays, and parts/material recommended and approved by manufacturer of automatic operator for each individual leaf. Actuators control both doors simultaneously at pairs. Sequence operation of exterior and vestibule doors with automatic operators to allow ingress or egress through both sets of openings as directed by Architect. Locate actuators, key switches, and other controls as directed by Architect.
10. Provide units with vestibule inputs that allow sequencing operation of two units, and SPDT relay for interfacing with latching or locking devices.

B.16 DOOR TRIM

B.16.1 Manufacturers:

1. Scheduled Manufacturer:
 - a. Ives

2. Acceptable Manufacturers:

- a. Elmes
- b. Trimco
- c. Burns

B.16.2 Requirements:

- 1. Provide push plates, push bars, pull plates, pulls, and hands-free reversible door pulls with diameter and length as scheduled.

B.17 PROTECTION PLATES

B.17.1 Manufacturers:

- 1. Scheduled Manufacturer:
 - a. Ives
- 2. Acceptable Manufacturers:
 - a. Burns
 - b. Trimco

B.17.2 Requirements:

- 1. Provide protection plates with a minimum of 0.050 inch (1 mm) thick, beveled four edges as scheduled. Furnish with sheet metal or wood screws, finished to match plates.
- 2. Sizes plates 2 inches (51 mm) less width of door on single doors, pairs of doors with a mullion, and doors with edge guards. Size plates 1 inch (25 mm) less width of door on pairs without a mullion or edge guards.
- 3. At fire rated doors, provide protection plates over 16 inches high with UL label.

B.18 OVERHEAD STOPS AND OVERHEAD STOP/HOLDERS

B.18.1 Manufacturers:

- 1. Scheduled Manufacturers:
 - a. Glynn-Johnson
- 2. Acceptable Manufacturers:
 - a. ABH

B.18.2 Requirements:

- 1. Provide overhead stop at any door where conditions do not allow for a wall stop or floor stop presents tripping hazard.
- 2. Provide friction type at doors without closer and positive type at doors with closer.

B.19 DOOR STOPS AND HOLDERS

B.19.1 Manufacturers:

- 1. Scheduled Manufacturer:
 - a. Ives
- 2. Acceptable Manufacturers:
 - a. Trimco
 - b. Burns

B.19.2 Provide door stops at each door leaf:

1. Provide wall stops wherever possible. Provide concave type where lockset has a push button of thumbturn.
2. Where a wall stop cannot be used, provide universal floor stops.
3. Where wall or floor stop cannot be used, provide overhead stop.
4. Provide roller bumper where doors open into each other and overhead stop cannot be used.

B.20 THRESHOLDS, SEALS, DOOR SWEEPS, AUTOMATIC DOOR BOTTOMS, AND GASKETING

B.20.1 Manufacturers:

1. Scheduled Manufacturer:
 - a. Zero International
2. Acceptable Manufacturers:
 - a. National Guard
 - b. Reese

B.20.2 Requirements:

1. Provide thresholds, weather-stripping, and gasketing systems as specified and per architectural details. Match finish of other items.
2. Smoke- and Draft-Control Door Assemblies: Where smoke- and draft-control door assemblies are required, provide door hardware that meets requirements of assemblies tested according to UL 1784 and installed in compliance with NFPA 105.
3. Provide door sweeps, seals, astragals, and auto door bottoms only of type where resilient or flexible seal strip is easily replaceable and readily available.
4. Size thresholds 1/2 inch (13 mm) high by 5 inches (127 mm) wide by door width unless otherwise specified in the hardware sets or detailed in the drawings.

B.21 SILENCERS

B.21.1 Manufacturers:

1. Scheduled Manufacturer:
 - a. Ives
2. Acceptable Manufacturers:
 - a. Burns
 - b. Trimco

B.21.2 Requirements:

1. Provide "push-in" type silencers for hollow metal or wood frames.
2. Provide one silencer per 30 inches (762 mm) of height on each single frame, and two for each pair frame.
3. Omit where gasketing is specified.

B.22 FINISHES -- GENERAL

B.22.1 FINISH: BHMA 626/652 (US26D); EXCEPT:

1. Aluminum Geared Continuous Hinges: BHMA 628 (US28)
2. Push Plates, Pulls, and Push Bars: BHMA 630 (US32D)
3. Protection Plates: BHMA 630 (US32D)
4. Overhead Stops and Holders: BHMA 630 (US32D)

5. Door Closers: MTLPC
6. Wall Stops: BHMA 626 (US32D)
7. Weatherstripping: Clear Anodized Aluminum
8. Thresholds: Mill Finish Aluminum

B.22.2 FINISH: ALUMINUM DOORS & FRAMES--BHMA 643E/716 (US11); EXCEPT:

1. Door Closers: Powder Coat to Match.
2. Weatherstripping: Dark Bronze Anodized Aluminum.
3. Thresholds: Extruded Architectural Bronze, Oil-Rubbed

B.22.3 FINISH: STAINLESS-STEEL DOOR & FRAME--BHMA 630 (US32D); EXCEPT:

1. Aluminum Geared Continuous Hinges: BHMA 628 (US28)
2. Door Closers: Powder Coat to Match
3. Weatherstripping: Clear Anodized Aluminum
4. Thresholds: Mill Finish Aluminum

C Construction Door Hardware

C.1 EXAMINATION

1. Prior to installation of hardware, examine doors and frames, with Installer present, for compliance with requirements for installation tolerances, labeled fire-rated door assembly construction, wall and floor construction, and other conditions affecting performance. Verify doors, frames, and walls have been properly reinforced for hardware installation.
2. Field verify existing doors and frames receiving new hardware and existing conditions receiving new openings. Verify that new hardware is compatible with existing door and frame preparation and existing conditions.
3. Examine roughing-in for electrical power systems to verify actual locations of wiring connections before electrified door hardware installation.
4. Submit a list of deficiencies in writing and proceed with installation only after unsatisfactory conditions have been corrected.

C.2 PREPARATION

C.2.1 Where on-site modification of doors and frames is required:

1. Carefully remove existing door hardware and components being reused. Clean, protect, tag, and store according to storage and handling requirements specified herein.
2. Field modify and prepare existing doors and frames for new hardware being installed.
3. When modifications are exposed to view, use concealed fasteners, when possible.
4. Prepare hardware locations and reinstall according to installation requirements for new door hardware and with:
 - a. Steel Doors and Frames: For surface applied door hardware, drill and tap doors and frames according to ANSI/SDI A250.6.
 - b. Wood Doors: DHI WDHS.5 "Recommended Hardware Reinforcement Locations for Mineral Core Wood Flush Doors."
 - c. Doors in rated assemblies: NFPA 80 for restrictions on on-site door hardware preparation.

C.3 INSTALLATION

C.3.1 Mount door hardware units at heights to comply with the following, unless otherwise indicated or required to comply with governing regulations.

1. Standard Steel Doors and Frames: ANSI/SDI A250.8.
2. Custom Steel Doors and Frames: HMMA 831.
3. Interior Architectural Wood Flush Doors: ANSI/WDMA I.S. 1A
4. Installation Guide for Doors and Hardware: DHI TDH-007-20
 - a. Install door hardware according to NFPA 80, NFPA 101 and provide post-install inspection, testing as specified in section 1.03.E unless otherwise required to comply with governing regulations.
 - b. Install each hardware item in compliance with manufacturer's instructions and recommendations, using only fasteners provided by manufacturer.
 - c. Do not install surface mounted items until finishes have been completed on substrate. Protect all installed hardware during painting.
 - d. Set units level, plumb and true to line and location. Adjust and reinforce attachment substrate as necessary for proper installation and operation.
 - e. Drill and countersink units that are not factory prepared for anchorage fasteners. Space fasteners and anchors according to industry standards.
 - f. Install operating parts so they move freely and smoothly without binding, sticking, or excessive clearance.
 - g. Hinges: Install types and in quantities indicated in door hardware schedule but not fewer than quantity recommended by manufacturer for application indicated.
 - h. Lock Cylinders:
 - i. Install construction cores to secure building and areas during construction period.
 - ii. Replace construction cores with permanent cores as indicated in keying section.
 - iii. Furnish permanent cores to Owner for installation.
 - i. Wiring: Coordinate for:
 - i. Conduit, junction boxes and wire pulls.
 - ii. Connections to and from power supplies to electrified hardware.
 - iii. Connections to fire/smoke alarm system and smoke evacuation system.
 - iv. Connection of wire to door position switches and wire runs to central room or area, as directed by Architect.
 - v. Connections to panel interface modules, controllers, and gateways.
 - vi. Testing and labeling wires with Architect's opening number.
 - j. Key Control System: Tag keys and place them on markers and hooks in key control system cabinet, as determined by final keying schedule.
 - k. Door Closers: Mount closers on room side of corridor doors, inside of exterior doors, and stair side of stairway doors from corridors. Mount closers so they are not visible in corridors, lobbies and other public spaces unless approved by Architect.
 - l. Closer/holders: Mount closer/holders on room side of corridor doors, inside of exterior doors, and stair side of stairway doors.

- m. Power Supplies: Locate power supplies as indicated or, if not indicated, above accessible ceilings or in equipment room, or alternate location as directed by Architect.
- n. Thresholds: Set thresholds in full bed of sealant complying with requirements specified in Section "Joint Sealants."
- o. Stops: Provide floor stops for doors unless wall or other type stops are indicated in door hardware schedule. Do not mount floor stops where they may impede traffic or present tripping hazard.
- p. Perimeter Gasketing: Apply to head and jamb, forming seal between door and frame.
- q. Meeting Stile Gasketing: Fasten to meeting stiles, forming seal when doors are closed.
- r. Door Bottoms and Sweeps: Apply to bottom of door, forming seal with threshold when door is closed.

C.4 ADJUSTING

- 1. Initial Adjustment: Adjust and check each operating item of door hardware and each door to ensure proper operation or function of every unit. Replace units that cannot be adjusted to operate as intended. Adjust door control devices to compensate for final operation of heating and ventilating equipment and to comply with referenced accessibility requirements.
 - a. Door Closers: Adjust sweep period to comply with accessibility requirements and requirements of authorities having jurisdiction.
- 2. Occupancy Adjustment: Approximately three to six months after date of Substantial Completion, examine and readjust each item of door hardware, including adjusting operating forces, as necessary to ensure function of doors and door hardware.

C.5 CLEANING AND PROTECTION

- 1. Clean adjacent surfaces soiled by door hardware installation.
- 2. Clean operating items per manufacturer's instructions to restore proper function and finish.
- 3. Provide final protection and maintain conditions that ensure door hardware is without damage or deterioration at time of Substantial Completion.

C.6 DOOR HARDWARE SCHEDULE

- 1. The intent of the hardware specification is to specify the hardware for interior and exterior doors, and to establish a type, continuity, and standard of quality. However, it is the door hardware supplier's responsibility to thoroughly review existing conditions, schedules, specifications, drawings, and other Contract Documents to verify the suitability of the hardware specified.
- 2. Discrepancies, conflicting hardware, and missing items are to be brought to the attention of the architect with corrections made prior to the bidding process. Omitted items not included in a hardware set should be scheduled with the appropriate additional hardware required for proper application.

- Hardware items are referenced in the following hardware schedule. Refer to the above specifications for special features, options, cylinders/keying, and other requirements.

Hardware Sets:

Hardware Group No. 001

For use on Door #(s):

100

Provide each PR door(s) with the following:

QTY		DESCRIPTION	CATALOG NUMBER	FINISH	MFR
6	EA	HINGE	5BB1HW 4.5 X 4.5 NRP	630	IVE
2	EA	FIRE EXIT HARDWARE	9849-L-F-06-LBL	630	VON
2	EA	RIM HOUSING	20-079	626	SCH
2	EA	PERMANENT CORE	MATCH EXISTING	626	SCH
2	EA	TEMP CONST. CORE		622	SCH
2	EA	OVERHEAD STOP	100S	630	GLY
2	EA	FIRE/LIFE CLOSER	4414ME B80	MTLPC	LCN
2	EA	MOUNTING PLATE	4410ME-18G	689	LCN
1	EA	GASKETING	488SBK PSA	BK	ZER
2	SET	MEETING STILE	8193AA-S	AA	ZER
1	EA	WEATHERSTRIPPING	8217SBK PSA	BK	ZER
2	EA	TRANSFORMER	4040SE-3210		LCN
1	EA		POINT TO POINT DIAGRAM		
1	EA		RISER/ELEVATION DRAWING		
1	EA	FIRE ALARM CONTACT	AS SPECIFIED		B/O

NOTES:

- THE 'ME' CLOSERS SHALL BE WIRED TO THE FIRE ALARM PANEL THROUGH A SET OF NORMALLY CLOSED, DRY CONTACTS.
- THE FIRE ALARM CONTACTS SHALL BE PROVIDED BY THE FIRE ALARM CONTRACTOR.

OPERATIONAL DESCRIPTION:

- THE 'ME' CLOSERS SHALL BE CONTINUOUSLY ENERGIZED, ALLOWING THE DOORS TO BE HELD-OPEN UNDER NORMAL BUILDING CONDITIONS.

FIRE ALARM ACTIVATION:

- IF THE FIRE ALARM IS ACTIVATED, POWER TO THE 'ME' CLOSERS WILL BE DISCONNECTED, CAUSING THE DOORS TO CLOSE.

Hardware Group No. 002

For use on Door #(s):

101 102 106

Provide each PR door(s) with the following:

QTY		DESCRIPTION	CATALOG NUMBER	FINISH	MFR
2	EA	CONT. HINGE	112XY EPT	313AN	IVE
2	EA	POWER TRANSFER	EPT10	695	VON
1	EA	ELEC PANIC HARDWARE	LXRX-LC-QEL-3549A-EO 24 VDC	643E	VON
1	EA	ELEC PANIC HARDWARE	LXRX-LC-QEL-3549A-NL-OP-388 24 VDC	643E	VON
1	EA	RIM CYL. HOUSING	20-079	643e	SCH
1	EA	PERMANENT CORE	MATCH EXISTING	626	SCH
1	EA	FSIC CORE	MATCH EXISTING	606	SCH
1	EA	TEMP CONST. CORE		622	SCH
1	EA	MORTISE CYLINDER	MATCH EXISTING	626	SCH
2	EA	LONG DOOR PULL	9264F 36" O	643E/7 16	IVE
1	EA	SURFACE CLOSER	4021 MC	695	LCN
1	EA	SURF. AUTO OPERATOR	4642 WMS	695	LCN
1	EA	MOUNTING PLATE	4020-18G	695	LCN
1	EA	WEATHER RING	8310-801	PLA	LCN
2	EA	JAMB ACTUATOR BUTTON	8310-818T	630	LCN
1	EA	FLUSH MOUNT BOX	8310-819F	689	LCN
1	EA	ACTUATOR, WALL MOUNT	8310-853T	630	LCN
1	EA	BOLLARD POST	8310-866	DKBRZ	LCN
1	EA	FLUSH MOUNT BOX	8310-867F	689	LCN
1	SET	MEETING STILE SEAL	FURNISHED UNDER SECTION 08 41 00		B/O
1	SET	DOOR SEAL	FURNISHED UNDER SECTION 08 41 00		B/O

QTY		DESCRIPTION	CATALOG NUMBER	FINISH	MFR
2	EA	DOOR SWEEP	8198D	D	ZER
1	EA	THRESHOLD	654A-E	A	ZER
1	EA	KEY SWITCH	653-1415 L2 24VDC	630	SCE
1	EA	POWER SUPPLY	PS902 BBK 900-2RS	LGR	SCE
1	EA		POINT TO POINT DIAGRAM		
1	EA		RISER/ELEVATION DRAWING		

NOTES:

1. THE LX-LC SWITCHES INSIDE THE EXIT DEVICES SHALL BE WIRED IN SERIES WITH THE EXTERIOR ACTUATOR.

2. THE WALL ACTUATOR ON THE INSIDE OF THE OPENING SHALL ALWAYS BE ENABLED.
OPERATIONAL DESCRIPTION:

1. THE DOORS SHALL BE NORMALLY CLOSED AND LOCKED.

2. FREE EGRESS SHALL ALWAYS BE POSSIBLE.

3. THE KEY SWITCH SHALL CONTROL THE LOCKING AND UNLOCKING OF THE OPENING.

4. WHEN THE KEY SWITCH IS TURNED TO THE 'ON' POSITION, THE FOLLOWING
SIMULTANEOUS ACTIONS WILL OCCUR:

A. THE LATCHBOLTS ON THE EXIT DEVICES SHALL RETRACT, UNLOCKING THE OPENING.

B. THE EXTERIOR WALL ACTUATOR SHALL BE ENABLED.

5. IN THIS UNLOCKED MODE, EITHER WALL ACTUATOR MAY BE PUSHED TO ACTIVATE THE AUTOMATIC OPERATOR AND OPEN THE DOORS.

6. WHEN THE KEY SWITCH IS TURNED BACK TO THE 'OFF' POSITION, THE FOLLOWING
ACTIONS WILL OCCUR:

A. POWER TO THE EXIT DEVICES WILL BE REMOVED, CAUSING THE LATCHBOLTS TO EXTEND AND RE-SECURE THE OPENING.

B. THE EXTERIOR WALL ACTUATOR WILL BE DISABLED.

7. IN THIS LOCK MODE, THE INTERIOR ACTUATOR MAY STILL BE PUSHED TO ACTIVATE THE SYSTEM AND OPEN THE DOORS.

8. WHEN THE INTERIOR ACTUATOR IS PUSHED DURING A LOCK MODE, THE FOLLOWING
SEQUENTIAL ACTIONS WILL OCCUR:

A. POWER TO THE EXIT DEVICES WILL BE APPLIED, CAUSING THE LATCHBOLTS TO RETRACT AND UNLOCK THE DOORS.

B. THE AUTOMATIC OPERATOR WILL BE ACTIVATED AND OPEN THE DOORS.

9. ONCE THIS CYCLE HAS BEEN COMPLETED, THE DOORS WILL RETURN TO A CLOSED AND LOCKED STATE.

10. THE DOORS MAY BE OPERATED MANUALLY FROM THE INSIDE AT ALL TIMES.

11. WHEN AN INDIVIDUAL PUSHES ON THE TOUCHBAR OF EITHER EXIT DEVICE, THE
FOLLOWING ACTIONS WILL OCCUR:

A. THE LATCHBOLTS WILL MECHANICALLY RETRACT, UNLOCKING THE DOOR TO ALLOW THE INDIVIDUAL TO EGRESS.

LOSS OF POWER:

1. THE DOORS SHALL REMAIN CLOSED AND LOCKED UPON LOSS OF POWER.

2. MECHANICAL OPERATION OF THE OPENING IS STILL POSSIBLE.

Hardware Group No. 003

For use on Door #(s):

103

Provide each PR door(s) with the following:

QTY		DESCRIPTION	CATALOG NUMBER	FINISH	MFR
2	EA	CONT. HINGE	224XY	628	IVE
1	EA	PANIC HARDWARE	LD-9849-EO	626	VON
1	EA	PANIC HARDWARE	LD-9849-L-NL-06	626	VON
1	EA	RIM HOUSING	20-079	626	SCH
1	EA	PERMANENT CORE	MATCH EXISTING	626	SCH
1	EA	TEMP CONST. CORE		622	SCH
2	EA	SURFACE CLOSER	4111 SCUSH MC ST-1586	689	LCN
2	EA	KICK PLATE	8400 10" X 1" LDW B-CS	630	IVE
1	EA	RAIN DRIP	142AA	AA	ZER
1	EA	GASKETING	429AA-S	AA	ZER
2	EA	DOOR SWEEP	8198AA	AA	ZER
1	EA	THRESHOLD	655A-E	A	ZER

Hardware Group No. 004

For use on Door #(s):

103A

Provide each SGL door(s) with the following:

QTY		DESCRIPTION	CATALOG NUMBER	FINISH	MFR
1	EA	CONT. HINGE	224XY	628	IVE
1	EA	STOREROOM LOCK	L9080L 06A	626	SCH
1	EA	PERMANENT CORE	MATCH EXISTING	626	SCH
1	EA	TEMP CONST. CORE		622	SCH
1	EA	MORTISE CYLINDER	MATCH EXISTING	626	SCH
1	EA	SURFACE CLOSER	4111 EDA MC	689	LCN

QTY		DESCRIPTION	CATALOG NUMBER	FINISH	MFR
1	EA	KICK PLATE	8400 10" X 1" LDW B-CS	630	IVE
1	EA	WALL STOP	WS33/WS33X	626	IVE
3	EA	SILENCER	SR64	GRY	IVE

Hardware Group No. 005

For use on Door #(s):

104 105 107

Provide each PR door(s) with the following:

QTY		DESCRIPTION	CATALOG NUMBER	FINISH	MFR
2	EA	CONT. HINGE	224XY	628	IVE
1	EA	CONST LATCHING BOLT	FB51P	630	IVE
1	EA	DUST PROOF STRIKE	DP1	626	IVE
1	EA	STOREROOM LOCK	L9080L 06A	626	SCH
1	EA	PERMANENT CORE	MATCH EXISTING	626	SCH
1	EA	TEMP CONST. CORE		622	SCH
1	EA	MORTISE CYLINDER	MATCH EXISTING	626	SCH
2	EA	SURFACE CLOSER	4111 SCUSH MC ST-1586	689	LCN
2	EA	KICK PLATE	8400 10" X 1" LDW B-CS	630	IVE
1	EA	RAIN DRIP	142AA	AA	ZER
1	EA	GASKETING	429AA-S	AA	ZER
1	EA	OVERLAPPING ASTRAGAL	FURNISHED BY THE DOOR SUPPLIER.	600	B/O
2	EA	DOOR SWEEP	8198AA	AA	ZER
1	EA	THRESHOLD	655A-E	A	ZER

Hardware Group No. 006

For use on Door #(s):

108 300 301

Provide each SGL door(s) with the following:

QTY		DESCRIPTION	CATALOG NUMBER	FINISH	MFR
1	EA	CONT. HINGE	224XY	628	IVE
1	EA	STOREROOM LOCK	L9080L 06A	626	SCH
1	EA	PERMANENT CORE	MATCH EXISTING	626	SCH
1	EA	TEMP CONST. CORE		622	SCH
1	EA	MORTISE CYLINDER	MATCH EXISTING	626	SCH
1	EA	SURFACE CLOSER	4111 SCUSH MC ST-1586	689	LCN
1	EA	RAIN DRIP	142AA	AA	ZER
1	EA	GASKETING	429AA-S	AA	ZER
1	EA	DOOR SWEEP	8198AA	AA	ZER
1	EA	THRESHOLD	655A-E	A	ZER

Hardware Group No. 007

For use on Door #(s):

109

Provide each SGL door(s) with the following:

QTY		DESCRIPTION	CATALOG NUMBER	FINISH	MFR
1	EA	CONT. HINGE	224XY	628	IVE
1	EA	STOREROOM LOCK	L9080L 06A	626	SCH
1	EA	PERMANENT CORE	MATCH EXISTING	626	SCH
1	EA	TEMP CONST. CORE		622	SCH
1	EA	MORTISE CYLINDER	MATCH EXISTING	626	SCH
1	EA	OVERHEAD STOP	100S	630	GLY
1	EA	SURFACE CLOSER	4011 MC ST-1544	693	LCN
1	EA	MOUNTING PLATE	4020-18	689	LCN

QTY		DESCRIPTION	CATALOG NUMBER	FINISH	MFR
1	EA	KICK PLATE	8400 10" X 1" LDW B-CS	630	IVE
3	EA	SILENCER	SR64	GRY	IVE

Hardware Group No. 008

For use on Door #(s):

302 303

Provide each SGL door(s) with the following:

QTY		DESCRIPTION	CATALOG NUMBER	FINISH	MFR
1	EA	CONT. HINGE	224XY	628	IVE
1	EA	STOREROOM LOCK	L9080L 06A	626	SCH
1	EA	PERMANENT CORE	MATCH EXISTING	626	SCH
1	EA	TEMP CONST. CORE		622	SCH
1	EA	MORTISE CYLINDER	MATCH EXISTING	626	SCH
1	EA	SURFACE CLOSER	4111 SCUSH MC ST-1586	689	LCN
1	EA	RAIN DRIP	142AA	AA	ZER
1	EA	GASKETING	429AA-S	AA	ZER
1	EA	DOOR SWEEP	8198AA	AA	ZER
1	EA	THRESHOLD	655A-E	A	ZER

NOTE:

1. INSTALL THE LOCKSET IN THE FOLLOWING MANNER: KEYED ACCESS TO THE ROOF SHALL ALWAYS BE REQUIRED; FREE EGRESS FROM THE ROOF SHALL ALWAYS BE POSSIBLE.

D Measurement

The department will count Doors and Door Hardware once for each individual unit, acceptably completed.

E Payment

The department will pay for measured quantities at the contract unit price under the following bid item:

ITEM NUMBER	DESCRIPTION	UNIT
SPV.0060.07	Doors and Door Hardware	EACH

Payment is full compensation after installation of all doors and all hardware

30. Utility Line Opening (ULO), Item SPV.0060.08.

A Description

This special provision describes excavating to uncover utilities for the purpose of determining elevation and potential conflicts as shown on the plans or as directed by the engineer.

B (Vacant)

C Construction

Perform the excavation in such a manner that the utility in question is not damaged and the safety of the workers is not compromised.

Perform the utility line openings as soon as possible and at least 10 days in advance of proposed utility construction to allow any conflicts to be resolved with minimal disruption. Give the engineer a minimum of three working days once utility line opening information is received to review all relevant design information prior to proposed utility construction. Where utilities are within 6 feet of each other at a potential conflict location, only one utility line opening will be called for. In these cases, a single utility line opening will be considered full payment to locate multiple utilities. Utility line openings include a trench up to 10 feet long as measured at the trench bottom, and of any depth required to locate the intended utility.

Approve and coordinate all utility line openings with the engineer. Notify the utility field engineers or their agents of this work a minimum of 3 days prior to the work so they may be present when the work is completed.

Replace pavement over utility line opening trenches which are within the staged traffic area as directed by the engineer. Replace pavement and open to traffic within 24 hours of the excavation.

D Measurement

The department will measure Utility Line Opening by the unit each.

E Payment

The department will pay for measured quantities at the contract unit price under the following bid item:

ITEM NUMBER	DESCRIPTION	UNIT
SPV.0060.01	Utility Line Opening (ULO)	EACH

Payment is full compensation for the excavation required to expose the utility line; backfilling with existing material removed from the excavation; compacting the backfill material; restoring the site; cleanup; and for furnishing all labor, tools, equipment, transportation, and incidentals to perform the work.

Existing pavement, concrete curb, gutter, and sidewalk removals necessary to facilitate utility line openings are not considered part of or paid for under Utility Line Openings but are considered separate and measured and paid for separately as removal items. Pavement replacement material, concrete curb, gutter, and sidewalk items will also be considered separate from Utility Line Openings and will be measured and paid for separately.

31. Marking Line Paint Text 4-Inch Black, Item SPV.0060.09.

A Description

This special provision describes providing the stencil and providing and placing marking line paint text 4-inch at the locations on the proposed platform specified in the plans according to the pertinent provisions of standard spec 646 and as hereinafter provided.

B (Vacant)

C Construction

Apply 4-inch tall, 3-inch wide black matte finish text on top of the 4.5-inch yellow marking at the spacing the plan details show.

D Measurement

The department will measure Marking Line Paint Text 4-Inch Black as each unit of work, acceptably completed.

E Payment

The department will pay for measured quantities at the contract unit price under the following bid item.

ITEM NUMBER	DESCRIPTION	UNIT
SPV.0060.09	Marking Line Paint Text 4-Inch Black	EACH

Payment is full compensation for providing a stencil, providing and installing the marking, and any incidentals necessary to complete the contract work.

32. Pipe Bollard, Item SPV.0060.10.

A Description

This special provision describes furnishing and installing pipe bollards at locations as detailed in the plans and as hereinafter provided.

B Materials

Fabricate pipe bollards from schedule 80 galvanized steel pipe. Provide concrete according to standard spec 501 conforming to Grade A, A-FA, A-S, A-T, A-IS, A-IP, and A-IT.

C Construction

Paint the pipe bollards as specified in standard spec 517.2.4, color blue. Paint the pipe bollards according to standard spec 517.3. For the portion of the pipe bollard that will be fully encased in concrete, apply only the zinc-rich primer as specified in standard spec 517.3.1.7.2.

Excavate to the depth required for installation. Remove water or other foreign material from the excavation and inside the pipe before placing concrete. Place concrete in the excavation and inside pipe in a continuous operation at a rate that will not cause air pockets. The concrete may not have cold joints. Fill the pipe completely with concrete and consolidate to a depth as great as practicable with a mechanical vibrator or by other engineer-approved method.

Protect the pipe bollards from damage to the paint during transportation, storage, placement and concrete placement. Repair any damaged paint according to standard spec 517.3.

D Measurement

The department will measure Pipe Bollard as each individual pipe bollard, acceptably completed.

E Payment

The department will pay for measured quantities at the contract unit price under the following bid item:

ITEM NUMBER	DESCRIPTION	UNIT
SPV.0060.10	Pipe Bollard	EACH

Payment is full compensation for providing pipe, concrete, and paint; for excavation; for placing concrete within the pipe and for the footing; for backfilling and disposing of surplus materials; and for repairs to the paint system.

33. Sanitary Manhole 4-Foot, Item SPV.0060.11.

A Description

This special provision describes providing manhole(s) for sanitary sewer. Manhole(s) shall be located at the locations specified on the plans when laying sanitary sewer. Spacing of manholes shall be at a maximum of 400 feet according to NR 110.13 for sewers of 15 inches or less. Manhole barrels shall be constructed of pre-cast reinforced concrete sections. The minimum diameter of manholes shall be 48 inches for pipe that is 8" to 24" in diameter.

B Materials

Pre-cast manholes and tops shall conform with ASTM Specifications, C478, latest revision. Pre-cast manholes are to be provided with eccentric cones. The minimum wall thickness shall be in conformance with the table on the detail sheet. Reinforced integral floors shall have a minimum thickness of 6 inches.

The top of the pre-cast cone shall have minimum 3" vertical ring integrally cast with the cone. The surface shall be smooth and free of form offsets cracks or excessive honeycomb.

Each pre-cast reinforced concrete manhole riser and top section shall be clearly marked with the name or trademark of the manufacturer and the date of manufacture. This marking shall be indented into the manhole section or shall be painted thereon with waterproof paint.

Pipe Connection to Manhole: All sanitary sewer pipe to manhole connections shall be with a flexible, watertight pipe to manhole seal meeting the requirements of ASTM C-923 and ASTM F-2510. All new manholes will have factory installed boots built into the structure, prior to delivery to the jobsite.

Steps: Manholes deeper than four feet shall be provided with manhole steps conforming to Standard Specifications

Frame and Lid: All sanitary manholes shall be installed with a casting with self-sealing lid ground and machined bearing. Neenah R-1710 sanitary frame with solid lid or approved equal shall be used. The cover shall have one pick hole which allows no water to enter the manhole and shall be embossed or engraved with "SEWER", refer to the Detail Sheet.

Chimney Seal: All manholes shall have an internal chimney/external chimney approved by the engineer. The chimney seal shall extend from the top of the cone section to the base of the frame. Seal materials shall conform to ASTM C-877 or ASTM C-923. Any metal parts shall be made of Type 304 stainless steel.

Joints: Follow Standard Specifications for Sewer and Water Construction in Wisconsin (newest edition including all addendums),

C Construction

Install according to the "Standard Specifications". Set manhole rims to elevations indicated on plans.

D Measurement

The department will measure Sanitary Manholes by each unit, acceptably completed.

E Payment

The department will pay for measured quantities at the contract unit price under the following bid item:

ITEM NUMBER	DESCRIPTION	UNIT
SPV.0060.11	Sanitary Manhole 4-Foot	EACH

Payment is full compensation for frame and lid, insulation, bench work, seals and fittings. Furnish necessary materials, labor, excavation, bedding, cover and backfill materials, sheathing, shoring, dewatering, testing, cleanup and all incidentals necessary to complete the work.

**34. Grass, Blue Oat, Item SPV.0060.12;
Grass, Hameln Dwarf Fountain, Item SPV.0060.13;
Grass, Karl Foerster Reed, Item SPV.0060.14.**

A Description

This special provision describes furnishing and planting perennial plants and grasses of the species, varieties and sizes specified, according to standard spec 632, as modified in the article Furnishing and Planting Plant Materials, and as hereinafter provided.

B Materials

Provide plants of the specific species, variety, size, color and other characteristics as shown on the plans and Planting Data chart unless prior written approval of the engineer is provided in advance for any substitution.

C Construction

Plant perennials in a prepared pit 1 foot in diameter by 6 inches deep with a timed-release fertilizer thoroughly incorporated into the top 6" inches of planting soil at the manufacturers recommended rate. Use a fertilizer conforming to the following minimum requirements:

Nitrogen...	19%
Phosphoric Acid	6%
Potash...	12%

Thoroughly water-in plants to eliminate all air pockets in the planting pit.

Plant all perennials and grasses between September 1 and October 1, unless directed otherwise by the engineer.

D Measurement

The department will measure (Species) of each planted perennial, acceptably completed.

E Payment

The department will pay for measured quantities at the contract unit price under the following bid items:

ITEM NUMBER	DESCRIPTION	UNIT
SPV.0060.12	Grass, Blue Oat	EACH
SPV.0060.13	Grass, Hameln Dwarf Fountain	EACH
SPV.0060.14	Karl Foerster Reed	EACH

Payment is full compensation according to standard spec 632.5.

35. Remove and Salvage Lighting Equipment, Item SPV.0060.15.

A Description

This special provision describes removing, salvaging, and transporting existing light pole assemblies and removing electrical wire at all the locations specified in the plans according to the Standard Specifications and as hereinafter provided.

B (Vacant)

C Construction

Notify Owner at least three working days prior to the shutdown of the existing lighting system.

Complete this work immediately following shut down of the lighting system equipment. The lighting system shall be operational during nighttime hours for the duration of the project.

Salvage light poles and luminaire arms per plan from their concrete footing and disassemble out of traffic. Remove wiring/cabling from the pole and dispose of off department right-of-way. Ensure that access handhold doors and hardware remain intact. Inspect salvaged equipment for damage or defects

Remove all transformer bases, luminaire arms, and all lighting wire from the conduit system as noted on the plan. Dispose of all material outside the Owner right-of-way.

Transport GMIA salvaged lighting equipment to GMIA (Attn: Vincent Campagna)

D Measurement

The department will measure Remove and Salvage Lighting Equipment as each unit of work, acceptably completed.

E Payment

The department will pay for measured quantities at the contract unit price under the following bid item:

ITEM NUMBER	DESCRIPTION	UNIT
SPV.0060.15	Remove and Salvage Lighting Equipment	EACH

Payment is full compensation for removing, salvaging, disassembling, transporting, disposing of scrap material, protecting from damage, and incidentals necessary to complete the contract work.

The department will pay separately for lamp, ballast, LED, and switch disposal and detachment, handling, packaging, labeling and delivering for disposal.

36. Fall Restraint System, Item SPV.0060.16.

A Description

This special provision describes the full design, furnishing and installing a fall restraint system for pedestrian bridge window washing. The system should accommodate access to all windows located on the pedestrian bridge. Item includes the following:

- System design, including design of some supporting structural steel members and connections as shown in the plans
- Tieback anchorages
- Suspension line anchorages

A.1 Related Sections

- Structural Steel
- Metal Fabrications
- Membrane Roofing
- Sheet Metal Flashing and Trim
- Joint Sealants

A.2 References

Publications listed herein are part of this specification to extent referenced. The most recent edition of the publication shall govern unless noted otherwise.

1. Occupational Safety and Health Standard
 - a. 1910 Subpart D (Walking and Working Surfaces)
 - b. 1910.66 Appendix C (Personal Fall Arrest)
 - c. 1910.66 Subpart F (Powered Platforms)
2. American Iron and Steel Institute (AISI)
 - a. AISI S100 North American Specification for the Design of Cold-Formed Steel Structural Members
3. American Institute of Steel Construction (AISC)
 - a. AISC 360 Specification for Structural Steel Buildings
 - b. AISC Specifications for the Design of Cold-Formed Steel Structural Members
4. American Society for Testing and Materials (ASTM)
 - a. ASTM A36 Specification for Structural Steel
 - b. ASTM A123 Specification for Zinc (Hot-Dip Galvanized) Coatings on Iron and Steel Hardware
 - c. ASTM A500 Specification for Cold-Formed Welded and Seamless Carbon Steel Structural Tubing in Rounds and Shapes
 - d. ASTM A780 Practice for Repair of Damaged and Uncoated Areas of Hot-Dip Galvanized Coatings
 - e. ASTM B209-04 Specification for Aluminum and Aluminum-Alloy Sheet and Plate
 - f. ASTM B221-02 Specification for Aluminum and Aluminum-Alloy Extruded Bars, Wire, Shapes, and Tubes
 - g. ASTM B308/B308M-02 Standard Specification for Aluminum-Alloy 6061-T6 Standard Structural Profiles
 - h. ASTM A193 Specification for Alloy-Steel and Stainless-Steel Bolting Materials.
 - i. ASTM 436 Specification for Hardened Steel Washers
5. American Welding Society (AWS)
 - a. AWS D1.1 Structural Welding Code – Steel
 - b. AWS D1.2 Structural Welding Code – Aluminum
 - c. AWS D1.6 Structural Welding Code - Stainless Steel
6. International Code Council (ICC)
 - a. International Building Code (IBC) year as applicable to state or province where work is performed.
7. International Window Cleaning Association (IWCA)
 - a. IWCA I-14.1-2001 Window Cleaning Safety Standard

A.3 System Description

A.3.1 Anchorage Design Requirements

1. Safety anchorage system design shall comply with current OSHA, ANSI, IBC, and local regulations pertaining to window cleaning and fall protection in accordance with sections A.1 and A.2 of this specification.

2. Anchorage system shall provide independent fall arrest anchorages in addition to suspension line anchorages for each descent location as required by OSHA and The IWCA I-14.1-2001 Window Cleaning Safety Standard requirements.
3. System shall be designed to be compatible with current window cleaning industry standard equipment e.g., rope descent systems; boatswain chairs.
4. Structural design requirements of anchorages used for rope descent systems, lifelines, fall-arrest lines, and tie-backs.
 - a. Anchorages and the supporting structure, design by the Load and Resistance Factor Design methodology shall be capable of sustaining a minimum ultimate load of 5,000 lbs., in any direction the load may be applied, without fracture or failure, per OSHA 1910.27 (b)(1)(i).
 - b. Anchorages and the supporting structure, designed by the Allowable Strength Design methodology, shall be designed for a minimum unfactored load of 3,100 lb., in any direction the load may be applied per 2015 IBC, section 1607.9.4.
 - c. All anchorages shall be load tested prior to initial use, per OSHA 1910.27 (b)(1)(i). A professional structural engineer registered in the State of Wisconsin and employed by the manufacturer shall specify the load test prescription in accordance with the Authority Having Jurisdiction. The test load shall be a minimum 2,500 lb. with a tolerance of ± 5 percent. The anchorage shall be capable of sustaining the test load without permanent deformation or damage.
 - d. Parapet or guardrails subject to loading by workers' ropes or cables, shall be designed to withstand such loading.
 - e. The parapet tube support and base connection to the bridge structure shall be designed and detailed for the rope anchorage loading.
5. Locate primary support and fall arrest anchorages in conjunction with areas on façade of building needing to be serviced. Consideration shall be given to the type of suspension equipment that will be used at the building and conditions such as: workers' reach, rigging methods, and roof edge conditions. Anchorages shall be unobstructed and located inboard of and in line with equipment or portion of building they are intended to service. Anchorages shall not be located within 6 feet of the roof edge unless fall protection is provided to access those areas safely. Preferred anchorage locations are detailed in the plan. Final anchorage locations shall be determined by a qualified professional who has significant knowledge and experience regarding facade access methods and practices.

B Materials

B.1 Submittals

1. Product Data: Manufacturer's data sheets on each product proposed.
 - a. Test report certified by a professional engineer.
 - b. General product data.
 - c. Detailed drawings of equipment proposed.
 - d. Installation instructions.
2. Shop Drawings
 - a. Submit scaled shop drawings showing location plan of all support equipment and sections detailing all parts and accessories.
 - b. Clearly specify equipment dimensions, materials, fabrication details, hardware, and installation instructions. Where the proposed equipment and support system interfaces with other trades (i.e., structural steel framing, roof construction, wall construction), coordinate the details of the system with that trade.
 - c. Include notes with guidelines of proper use of system.

- d. Equipment location plan to include identification number next to each piece of equipment (i.e., anchorages and rigging sleeves) that are permanently affixed to a structure.
 - e. Field welds shall be indicated on equipment details using AWS symbols and showing length and size. Auxiliary views shall be shown to clarify welding as required.
 - f. Shop drawings shall be prepared under supervision of a registered professional engineer and shall bear engineer's seal and signature. Professional engineer shall be licensed in the State of Wisconsin. Include P.E. certified report of tested equipment.
3. Quality Assurance Submittal Certificates
- a. Provide documentation verifying company's amount of experience and successful performance in design, fabrication, and installation of permanent window washing equipment.
 - b. Submit listing of company's installations representing similar scope and complexity to project requirements for previous 10 years. List shall include information as follows:
 - i Project name and address
 - ii Name of owner
 - iii Name of contractor
 - iv Name of architect (if applicable)
 - v Date of completion
 - c. Provide documentation verifying that installers have been trained by the manufacturer and are competent.
4. Contract Close-out Submittals
- a. Operation and Maintenance
 - i Provide a safety inspection logbook for yearly inspections. Log book shall include a certification of compliance letter. The certification of compliance shall state that access system follows current OSHA regulations and IWCA I-14.1-2001 Window Cleaning Safety Standard.
 - b. Project Record Document Data
 - i Record anchorage locations and details.
 - ii Submit 2 copies of a reduced, plastic laminated Project Record Drawing showing as-installed anchorage locations, details, and instructional text in English (and Spanish upon request). Post one copy on interior of each roof door or adjacent to exit on roof; owner shall establish exact location.
 - iii Submit a letter of certification by a registered professional engineer licensed in the State of Wisconsin verifying that installed anchorages and system are in compliance with OSHA requirements as specified. Each piece of access equipment dedicated to the building shall be tested on site under the supervision of a P.E. in in-situ load test requirements following test procedures established by a professional engineer and the manufacturer's test procedure documents.

B.2 Quality Assurance

1. Qualifications
- a. Provide products from a company specializing in design, fabrication, and installation of permanent suspended access equipment with a minimum of 5 years documented experience. Companies like miscellaneous metal fabricators not normally engaged in design and fabrications of suspended access equipment are not acceptable.
 - b. Manufacturer and installer shall have specific liability insurance (products and completed operations) in an amount not less than \$5,000,000.
 - c. Installer(s) shall be trained or qualified by manufacturer in installation techniques and procedures of permanent suspended access equipment.

2. Regulatory Requirements and Safety Standards
 - a. Comply with Occupational Health and Safety Standards:
 - i IWCA I-14.1-2001 Window Cleaning Safety Standard, as applicable to rigging practices.
 - ii 1910 Subpart D (Walking and Working Surfaces)
 - iii 1910.66 Appendix C (Personal Fall Arrest)
 - iv 1910.66 Subpart F (Powered Platforms)
 - b. Welding shall comply with AWS D1.1, D1.2, and D1.6, and shall be performed by welders qualified to work in jurisdiction where project is located.
 - c. Comply with AISC standards:
 - i AISC 360 Specification for Structural Steel Buildings
 - d. Comply with AISI standard: AISI S100-16 North American Specification for the Design of Cold-Formed Steel Structural Members
 - e. Comply with the International Building Code requirements and locally adopted amendments and regulations.

B.3 Acceptable Manufacturers and Installers

1. Suspended Access and Fall Restraint System
 - a. Summit Anchor Company, Inc or approved equal.
2. Equivalent or superior materials and/or system substitutions shall be submitted to the Engineer for review.

B.4 Structural Components

1. Exposed Structural Components Finish: Galvanized Mild Steel or Stainless Steel
 - a. Steel: ASTM A572 GR 50
 - b. Steel: ASTM A A36
 - c. Galvanizing: ASTM A123
 - d. Stainless Steel; 304 ASTM A 193 Grade B8, Class 2
 - e. Aluminum; 6061-T6 Alloy
2. Yield Strength
 - a. 1. Base Plates and Bottom Plates, High Strength Steel: 50 ksi minimum
 - b. 2. Other Sections: 36 ksi minimum
3. Non-Structural Components
 - a. 1. Aluminum; 6061-T6 Alloy
 - b. 2. Alloys shall conform to requirements published in AA Aluminum Standards.
 - c. 3. Sheet and Plate: ASTM B209
 - d. 4. Extruded Bars, Rods, Shapes, and Tubes: ASTM B221
4. Hollow Structural Sections (HSS)
 - a. ASTM A500, Grade C
 - b. Yield Strength: 46 ksi minimum (round shapes) and 50 ksi (square and rectangular shapes)
 - c. Tensile Strength: 62 ksi minimum

5. Round Pipe Sections
 - a. ASTM A53, Grade B
 - b. Yield Strength: 35 ksi minimum
 - c. Tensile Strength: 60 ksi minimum
6. Nuts, Bolts, Davit Pins, and Washers
 - a. Stainless Steel; 304 ASTM A 193 Grade B8 or F593C
 - b. Galvanized Flat Washers ASTM F-436 or 18 -8 Stainless Steel
7. GAnchor Bolts (for securing base plate)
 - a. Metal: Stainless Steel, 304 Stainless Steel; ASTM A 193 Grade 8, B8
 - b. Size: 5/8 in. diameter minimum

B.5 Manufactured Units

1. Anchor
 - a. Capable of withstanding 5000 lbs. (2268kg) in any direction without permanent deformation.
 - b. Anchor eye size: forged eye with 2 ¼ in (60 mm) minimum eye opening.
 - c. Anchor eye metals:
 - i Forged, 1035 quenched and tempered per ASTM A576-90b, with 72 ksi minimum yield strength and 240-280 BHN.
 - d. Anchor tube height: not less than less than required by the roofing manufacturer.
2. Flashing with one E.P.D.M. gasket seal top and base
 - a. Seamless Spun Aluminum Flashing: ASTM B221; Type 6061-T6 alloy
 - b. Stainless Steel: 304
3. Load Testing
 - a. Each installed anchor assembly shall be load tested to 50 percent of its rated capacity, but not less than required by legally governing standards. Test results shall be certified by a P.E. with experience in suspended access equipment.

C Construction

C.1 Site Verification of Conditions

1. Examine areas and conditions under which permanent window washing equipment shall be installed.
2. Report to general contractor any conditions that deviate from shop drawings or any defects in workmanship that would cause an unsafe installation. This report shall be verified in writing to the general contractor and any other responsible party.
3. Correct conditions detrimental to timely and proper execution of work.
4. Do not proceed until unsatisfactory conditions have been corrected.
5. Commencement of installation constitutes acceptance of conditions and responsibility for satisfactory performance by installer.
6. Faults occurring in work of this section due to acceptance of unsatisfactory conditions shall be corrected at no additional cost to the department.

C.2 Fabrication

1. Fabricate work true to dimension, square, plumb, level, and free from distortion or defects detrimental to appearance and performance.

2. Grind off surplus welding material to ensure exposed surfaces are smooth so as not to abrade workers' ropes.
3. Welding shall be in accordance with the AWS Structural Welding Code D1.1, D1.2, and D1.6 as appropriate.

C.3 Delivery, Storage and Handling

1. Deliver materials in original unopened packaging.
2. Storage and Protection
 - a. Store materials in a protected area away from construction activities.
 - b. Clean bolts that have become dirty before installing.
 - c. Do not install damaged materials, removing them from site.

C.4 Sequencing and Coordination

1. General contractor is responsible for coordinating the schedule so as not to conflict with other trades.
2. The design and detailing of structural steel members and connections that directly support the anchoring system shall be coordinated directly with the structural steel fabricator for incorporation into the structural steel shop drawings and erection drawings. Where the anchoring system interfaces with other trades, coordinate directly with those trades on required accommodations.
3. Manufacturer to provide detailed installation instructions and directions for installation of embedded items, welded items, and through-bolted items, etc.
4. Manufacturer to provide installation assistance during installation of the equipment. However, the responsibility of the installation rest with the general contractor unless equipment is installed and certified by the manufacturer.

C.5 Installation

1. General Requirements
 - a. Install window washing system in compliance with manufacturer's instructions. Install equipment level, tightly fitted, and flush to adjacent surfaces as needed for proper installation.
 - b. Coordinate anchorage installation with roofing installation to ensure a watertight and warrantable condition of the roofing. Anchorages shall be directly flashed into roofing in a manner compatible with roofing system and anchors.
 - c. When components come into contact with dissimilar metals, surfaces shall be kept from direct contact to prevent corrosion.
 - d. No wall anchorages shall be installed through membrane roofing system without specification detailing such from the architect or water proofing company warranting the roof.
 - e. Threaded fasteners shall be secured to prevent accidental removal or vandalism by one of the following:
 - i Deformation of threads with 2/32" stainless steel punch
 - ii Stainless Steel Lock nuts.
 - iii Thread locking compound – light-tight 262 or equivalent.
2. Instructions for welding access equipment to structure
 - a. All welders must be certified to American Welding Society (AWS) in accordance with AWS standards.
 - b. Welds shall achieve a minimum strength, f_u , of 70 ksi.
 - c. Prior to welding anchorages to structure, abrasively remove, within one inch of all welded surfaces, galvanizing, mill, scale, and rust.
 - d. Immediately after welding, chip away slag to prepare for welding inspector to inspect welds.

- e. An AWS certified welding inspector must inspect and confirm size of all field welds. Following the inspection, a written report must be supplied to the building owner and/or general contractor. Welded joints shall not be painted until after welding has been completed and the weld accepted.
 - f. Immediately after an acceptable inspection, prepare and paint welded areas with cold-galvanizing coating to protect from corrosion. Coating shall have a minimum of 95 percent zinc, by weight, in the dried film.
 - g. Structural steel to receive roof or wall anchorages shall have a surface wide enough so that base plate can be welded all the way around. For example, anchorages equipped with 4½ in. (112.5 mm) base plates would require a minimum 5 in. (137.5 mm) wide surface to weld to.
3. Adhesive and Undercut Anchor Fasteners
 - a. Installation of anchoring equipment mounted with epoxy type anchor fasteners shall be performed by ACI accredited installers only.
 - b. Installation of anchoring equipment mounted with undercut type anchor fasteners shall be performed by installers certified by the anchor manufacturer.
 4. Roof Flashing Detail
 - a. Anchoring equipment shall be flashed in compliance with roofing manufacturer's instructions and the National Roofing Contractor Association recommendations. In case of a conflict, follow roofing manufacturer's recommendations. Ensure that installation is watertight.

C.6 Repair/Restoration

1. Galvanizing Touch-Up
 - a. Immediately after erection clean field welds and abraded areas. Repair damaged areas in compliance with ASTM A780. If a 'paint containing zinc dust' is used, paint shall have a minimum of 95 percent zinc, by weight, in the dried film.

C.7 Field Quality Control

1. Inspection and site visits
 - a. Inspections and site visits shall be performed while installation of equipment is in progress under the supervision of a qualified professional engineer registered in the State of Wisconsin.
 - b. On-site inspection of equipment welded to structure shall be performed by an AWS Certified Welding Inspector verifying, in writing, size and quality of welds. Such an inspection shall be performed on each piece of equipment before roofing material is installed.
 - c. On-site inspection shall be performed on all cast in place items while being tied in with the rebar with sufficient time before concrete is poured to allow to adjustments to embedded items as recommended by inspector.
 - d. The contractor shall be responsible to schedule above site visits and inspections with sufficient advance notice given to the department and inspection company.
2. Site Testing
 - a. All equipment shall be tested on site in accordance with manufacturer's recommendations, under the supervision of a professional engineer, before being placed in service.
 - b. Equipment shall be tested under the supervision of a professional engineer with experience with suspended maintenance equipment and manufacturer's guidelines.
3. Manufacturer shall assist and/or supervise installation of window washing equipment installed by others when such is included in contracted.

C.8 Adjusting

1. Verify that completed work has been installed correctly and products function properly. If adjustments are needed to ensure satisfactory operation, notify the Engineer and the system designer/supplier of the adjustments needed. The design engineer for the system shall approve adjustments to the system installation and, if necessary, revise the design calculations and shop drawings to reflect the adjustments.
2. Complete inspection logbook to certify system for use noting any deviations, changes, or corrections from original shop drawings. Provide as-built anchorage layout plan on 11 in. x 17 in. paper or larger together with annual inspection log book.

D Measurement

The department will measure Fall Restraint System by each system, acceptably completed. Individual anchorage points required for the Fall Restraint System will not be measured individually, but are considered to be parts of one system.

E Payment

The department will pay for measured quantities at the contract unit price under the following bid item:

ITEM NUMBER	DESCRIPTION	UNIT
SPV.0060.16	Fall Restraint System	EACH

Payment is full compensation for designing, furnishing, installing, and testing the window washing fall restraint system, including all anchorage points and supporting structural members required.

Fabrication and erection of structural steel members and connections that are designed as part of the support for the Fall Restraint System will be paid for under the bid item for Structural Steel.

37. HVAC Work, Item SPV. 0060.17.

A Description

A.1 Work Summary

This special provision describes the installation of the heating, ventilating and air conditioning (HVAC) equipment and systems.

A.2 Regulatory Requirements

A.2.1 State and Local Codes

Conform to all state and local code requirements.

A.2.2 Permits and Inspections

Obtain permits and request inspections from authority having jurisdiction and pay for all Permit fees incidental thereto.

A.3 Equipment Accessibility

Install equipment and materials to provide required access for servicing and maintenance. Coordinate the final location of concealed equipment and devices requiring access with final location of required access panels and doors. Allow ample space for removal of all parts that require replacement or servicing.

A.4 HVAC Installations

Coordinate HVAC equipment and materials installation with other building components. Verify all dimensions by field measurements. Arrange for chases, slots and openings in other building components to allow for HVAC installations. Install HVAC equipment to facilitate maintenance and repair or replacement of equipment components. Connect equipment for ease of disconnecting, with minimum interference with other installation.

A.5 Quality Assurance

Electrical characteristics for HVAC equipment: Equipment of higher electrical characteristics may be furnished provided such proposed equipment is approved in writing and connecting electrical services, circuit breakers, and conduit sizes are appropriately modified, and costs associated for modifications are included as part of the contractor's work. If minimum energy ratings or efficiencies are specified, equipment shall comply with requirements.

A.6 Delivery, Storage and Handling

Deliver HVAC materials with appropriate protective packaging with labels in place. Deliver ducts, pipe and tube with factory-applied end caps. Maintain end caps through shipping, storage and handling to prevent pipe end damage and to prevent entrance of dirt, debris and moisture.

A.7 References

National Fire Protection Association (NFPA)

- NFPA 54 (ANSI Z223.1) National Fuel Gas Code.
- NFPA 255 Building Materials, Test of Surface Burning Characteristics.
- NFPA 90A Installation of Air Conditioning and Ventilating Systems.
- NFPA 90B Installation of Warm Air Heating and Air Conditioning Systems.

American Society for Testing & Materials (ASTM)

- ASTM C612 Specification for Mineral Fiber Block and Board Thermal Insulation.
- ASTM B32 Specification for Solder Metal
- ASTM B280 Specification for Seamless Copper Tube for Air Conditioning and Refrigeration Field Service.
- ASTM A90 Test Method for Weight of Coating on Zinc-Coated (Galvanized Iron or Steel Articles.
- ASTM A525 Specification for General Requirements for Steel Sheet, Zinc-Coated (Galvanized) by the Hot Dip Process.
- ASTM A527 Specification for Steel Sheet, Zinc-Coated (Galvanized) by the Hot Dip Process, Lock Forming Quality.
- ASTM C553 Specification for Mineral Fiber Blanket and Felt Insulation (Industrial Type).

Underwriters Laboratories (UL)

- UL 723 Test for Surface Burning Characteristics of Building Materials.
- UL 181 Factory-Made Air Ducts and Connectors

American National Standards Institute (ANSI)

- ANSI/ASHRAE 34 Number Designation of Refrigerants.
- ANSI/ASME B16.22 Wrought Copper and Copper Alloy Solder-Joint Pressure Fittings.
- ANSI/ASME B31.5 Refrigeration Piping.
- ANSI/ARI 710 Driers, Liquid-Line.
- ANSI/ASHRAE 62.1 Ventilation for acceptable indoor air quality
- ANSI/ASHRAE 90a Energy Conservation in New Building Design.
- ANSI/ASHRAE 90.1 Energy Standard for Buildings Except Low-Rise Residential Buildings.
- ANSI/ASHRAE 103 Heating Seasonal Efficiency of Central Furnaces and Boilers, Methods of Testing.

Sheet Metal and Air Conditioning Contractors National Association (SMACNA)

- SMACNA Low Pressure Duct Construction Standards.

Air Movement and Control Association (AMCA)

- AMCA 99 Standards Handbook
- AMCA 210 Laboratory Methods of Testing Fans for Rating Purposes.
- AMCA 300 Test Code for Sound Rating Air Moving Devices.
- AMCA 301 Method of Calculating Fan Sound Ratings from Laboratory Test Data.

Air Conditioning and Refrigeration Institute (ARI)

- ARI 201/240 Unitary Air Conditioning and Air Source Heat Pump Equipment
- ARI 530 Positive Displacement Refrigerant Compressors, Compressor Units and Condensing Units.

Submittals

- Equipment and Material Shop Drawings

Submit shop drawings which include equipment information and product data for equipment listed below for review:

A.7.1 HVAC Systems and accessories

- Rooftop Air Conditioning Units
- Split System AC units
- Unit Heaters
- Air Curtains
- Exhaust fans
- Ductwork
- Piping

A.7.2 Report and Manuals Submittal

Submit the Reports and Manuals requested for review:

- HVAC Testing, Adjusting and Balancing (TAB) Report.
- HVAC operating and maintenance manual including warranty documentation.

B Materials

B.1 Basic HVAC System Materials and Methods.

B.1.1 Pipe, Tube, and Fittings – General

Pipe Threads: ASME B1.20.1 for factory-threaded pipe and pipe fittings.

B.1.2 Joining Materials – General

Solder Filler Metals: ASTM B 32, lead-free alloys. Include water-flushable flux according to ASTM B 813.
Brazing Filler Metals: AWS A5.8, BCuP Series, copper-phosphorus alloys for general-duty brazing, unless otherwise indicated; and AWS A5.8, BAg1, silver alloy for refrigerant piping, unless otherwise indicated.

B.1.3 Pipe Penetrations – General

Provide steel pipe sleeves with minimum wall thickness of 1/4 inch for pipes passing through beams and walls of concrete, brick, tile, or masonry, and 22 gage galvanized iron sleeves for pipes passing through other parts of construction. Provide steel pipe for all sleeves penetrating floors. Furnish each sleeve having inside diameter 1 inch larger than outside diameter of un-insulated and insulated pipe, unless wall or floor is a fire wall or barrier, in which case, only the pipe shall penetrate.

For pipes passing through floors, walls, and ceilings provide chrome-plated brass escutcheons having outside diameter to cover sleeved openings and inside diameter to fit pipe.

B.1.4 Non-rated surfaces

Stamped steel, chrome plated, hinged, split ring escutcheons or floor-ceiling plates for covering openings in occupied spaces.

In exterior wall openings below grade, use a modular mechanical type seal consisting of interlocking synthetic rubber links shaped to continuously fill the annular space between the uninsulated pipe and the cored opening or a water stop type wall sleeve.

At interior partitions where pipe penetrations are sealed, use Tremco Dymonic, Sika Corp. Sikaflex 1a, Sonneborn Sonolastic NPI, or Mameco Vulken 116 urethane caulk to affect the seal. Use galvanized sheet metal sleeves in hollow wall penetrations.

B.1.5 Duct Penetrations - General

Non-rated surfaces. Fiberglass insulation fill at voids with galvanized steel sheet metal bank-off on both sides of duct penetration through walls and ceiling structures. Use fire resistant sealant for sealing and soundproofing.

B.2 Identification and Painting for HVAC Systems

B.2.1 Materials – Identification Systems

Color: Unless specified otherwise, conform with ANSI/ASME A13.1.

Snap On Plastic Pipe Markers: Manufacturer's standard preprinted, semi rigid snap on, color coded pipe markers, conforming to ASME A13.1

Plastic Duct Markers: Manufacturer's standard laminated plastic, color coded duct markers. Conform to following color code:

- Yellow/Green: Supply air.
- Blue: Exhaust, outside, return, and mixed air.
- Plastic Equipment Markers: Laminated plastic, color coded equipment markers: Conform to following color code:
 - Green: Cooling equipment and components.
 - Yellow: Heating equipment and components.
 - Yellow/Green: Combination cooling and heating equipment and components.

Nomenclature: Include following, matching terminology on schedules as closely as possible:

- Name and plan ID number.
- Equipment service.
- Size: Approximately 2½ by 4 inches (65 by 100 mm) for control devices, dampers, and valves; and 4½ by 6 inches (115 by 150 mm) for equipment.

Lettering and Graphics: Coordinate names, abbreviations, and other designations used in mechanical identification, with corresponding designations indicated. Use numbers, letter, and wording indicated for proper identification and operation/maintenance of mechanical systems and equipment.

B.2.2 Materials – Paint Systems

Acceptable Manufacturers

- Tnemec.
- Carbolene.
- Or approved equal.

Painting Systems

Application on metal piping and pipe and equipment supports:

- Non-submerged, normal conditions, indoors.
- Generic Type: Polyamidoamine epoxy.
- Finish Coat: Tnemec Series 69.
- Interior: Two coats Series 69.
- Exterior: One coat Series 69, one coat Series 74.
- Primer Coat: Self priming.
- Minimum Dry Mil Thickness: 5 to 8 mil.
- Surface Preparation: Hand tool clean.

B.3 HVAC Ductwork Insulation

B.3.1 Manufacturers

Manufacturers: Subject to compliance with requirements, provide products by one of the following:

1. Glass Fiber:
 - a. Knauf Fiber Glass
 - b. Manville
 - c. Owens Corning Fiberglass Corporation

B.3.2 Materials

- Type A: Flexible Glass Fiber: ASTM C553 Type 1; "k" value of 0.29 at 75°F; foil scrim kraft facing with 0.02 perm rating.
- Type B: Board: ASTM C 612, Class 2, semi-rigid jacketed board "k" value of 0.23 @ 75°F; FSK facing with 0.02 perm rating.
- Adhesives: Waterproof fire-retardant type produced under the UL classification and follow-up service.
- Lagging Adhesive: Fire resistive to NFPA 255 or UL 723.
- Impale Anchors: Galvanized steel, 12 gage, self-adhesive pad.
- Joint Tape: Glass fiber cloth, FSK backing.

B.3.3 Duct Insulation Schedule

- Indoor, concealed supply and outdoor air: R6 mineral-fiber blanket insulation
- Indoor, exposed supply and outdoor air: R6 mineral-fiber board insulation
- Outdoor, supply, return and outdoor air: R8 mineral-fiber board insulation
- Supply, return and outdoor air ductwork exposed to outdoor conditions shall be protected by Aluminum jacketing.

B.4 Refrigerant Piping and Specialties

B.4.1 Piping

- Copper Tubing: ASTM B280, Type ACR hard drawn or annealed.
- Fittings: ANSI/ASME B16.22 wrought copper.
- Joints: ANSI/ASTM B32, solder Grade 95TA or ANSI/AWS A5.8 BCup silver braze.
- Factory precharged linesets are acceptable.

B.4.2 Refrigerant

Refrigerant: R-410A.

B.4.3 Moisture and Liquid Indicators

Indicators: Single or Double port type, UL listed, with copper or brass body, flared or solder ends, sight glass, color coded paper moisture indicator with removable element cartridge and plastic cap; suitable for system working pressure and temperature.

B.4.4 Refrigerant Piping Insulation

Flexible, 1" close-cell elastomeric pipe insulation conforming to ASTM C534 Grade 1, Type I: AP Armaflex with appropriate adhesive; Armaflex 520.

B.5 Ductwork

B.5.1 Materials

Comply with SMACNA's "HVAC Duct Construction Standards--Metal and Flexible" for acceptable materials, material thicknesses, and duct construction methods, unless otherwise indicated. Sheet metal materials shall be free of pitting, seam marks, roller marks, stains, discolorations, and other imperfections.

- Reinforcement Shapes and Plates: Galvanized-steel reinforcement where installed on galvanized sheet metal ducts, stainless steel where installed on stainless steel ducts.
- General: Non-combustible or conforming to requirements for Class 1 air duct materials, or UL 181.
- Steel Ducts: ASTM A525 or ASTM A527 galvanized steel sheet, lock-forming quality, having zinc coating of 1.25 oz per sq foot for each side in conformance with ASTM A90.
- Flexible Ducts: Interlocking spiral of galvanized steel or aluminum construction or fabric supported by helically wound spring steel wire or flat steel bands; rated to 2 inches WG positive and 1.5 inches WG negative for low pressure ducts.
- Fasteners: Rivets, bolts, or sheet metal screws. Use stainless steel fasteners on stainless steel ducts.
- Sealant: Non-hardening, water resistant, fire resistive, compatible with mating materials; liquid used alone or with tape, or heavy mastic.
- Tie Rods: Galvanized steel, 1/4-inch minimum diameter for lengths 36 inches or less; 3/8-inch minimum diameter for lengths longer than 36 inches.
- Hanger Rod: Steel, galvanized; threaded both ends, threaded one end, or continuously threaded.

B.5.2 Sealant Materials

Joint and Seam Sealants, General: The term "sealant" is not limited to materials of adhesive or mastic nature but includes tapes and combinations of open-weave fabric strips and mastics.

- Joint and Seam Tape: 2 inches wide; glass-fiber-reinforced fabric.
- Tape Sealing System: Woven-fiber tape impregnated with gypsum mineral compound and modified acrylic/silicone activator to react exothermically with tape to form hard, durable, airtight seal.
- Water-Based Joint and Seam Sealant: Flexible, adhesive sealant, resistant to UV light when cured, UL 723 listed, and complying with NFPA requirements for Class 1 ducts.
- Solvent-Based Joint and Seam Sealant: One-part, nonsag, solvent-release-curing, polymerized butyl sealant formulated with a minimum of 75 percent solids.
- Flanged Joint Mastic: One-part, acid-curing, silicone, elastomeric joint sealant complying with ASTM C 920, Type S, Grade NS, Class 25, Use O.
- Flange Gaskets: Butyl rubber or EPDM polymer with polyisobutylene plasticizer.

B.5.3 Hangers and Supports

- Building Attachments: Concrete inserts, powder-actuated fasteners, or structural-steel fasteners appropriate for construction materials to which hangers are being attached.
- Use powder-actuated concrete fasteners for standard-weight aggregate concretes or for slabs more than 4 inches thick.
- Exception: Do not use powder-actuated concrete fasteners for lightweight-aggregate concretes or for slabs less than 4 inches thick.
Hanger Materials: Galvanized sheet steel or threaded steel rod.
- Hangers Installed in Corrosive Atmospheres: Electrogalvanized, all-thread rods or galvanized rods with threads painted with zinc-chromate primer after installation.
- Strap and Rod Sizes: Comply with SMACNA's "HVAC Duct Construction Standards--Metal and Flexible" for steel sheet width and thickness and for steel rod diameters.
- Galvanized-steel straps attached to aluminum ducts shall have contact surfaces painted with zinc-chromate primer.
- Duct Attachments: Sheet metal screws, blind rivets, or self-tapping metal screws; compatible with duct materials.
- Trapeze and Riser Supports: Steel shapes complying with ASTM A 36/A 36M.
- Supports for Galvanized-Steel Ducts: Galvanized-steel shapes and plates.

B.5.4 Rectangular Duct Fabrication

Fabricate ducts, elbows, transitions, offsets, branch connections, and other construction according to SMACNA's "HVAC Duct Construction Standards--Metal and Flexible" and complying with requirements for metal thickness, reinforcing types and intervals, tie-rod applications, and joint types and intervals.

- Lengths: Fabricate rectangular ducts in lengths appropriate to reinforcement and rigidity class required for pressure class.
- Deflection: Duct systems shall not exceed deflection limits according to SMACNA's "HVAC Duct Construction Standards--Metal and Flexible."
- Transverse Joints: Prefabricated slide-on joints and components constructed using manufacturer's guidelines for material thickness, reinforcement size and spacing, and joint reinforcement.

Manufacturers:

- Ductmate Industries, Inc.
- Nexus Inc.
- Ward Industries, Inc.

Formed-On Flanges: Construct according to SMACNA's "HVAC Duct Construction Standards--Metal and Flexible," Figure 1-4, using corner, bolt, cleat, and gasket details.

Manufacturers:

- Ductmate Industries, Inc.
- Lockformer.

B.5.5 Round Duct and Fitting Fabrication

- Diameter as applied to flat-oval ducts in this Article is the diameter of a round duct with a circumference equal to the perimeter of a given size of flat-oval duct.
- Round, Spiral Lock -Seam Ducts: Fabricate supply ducts of galvanized steel according to SMACNA's "HVAC Duct Construction Standards--Metal and Flexible."

- Duct Joints: Ducts up to 48 Inches in Diameter: Interior, center-beaded slip coupling, sealed before and after fastening, attached with sheet metal screws.
- 90-Degree Tees and Laterals and Conical Tees: Fabricate to comply with SMACNA's "HVAC Duct Construction Standards--Metal and Flexible," with metal thicknesses specified for longitudinal-seam straight ducts.
- Diverging-Flow Fittings: Fabricate with reduced entrance to branch taps and with no excess material projecting from fitting onto branch tap entrance.

Fabricate elbows using die-formed, gored, pleated, or mitered construction. Unless elbow construction type is indicated, fabricate elbows as follows:

- Mitered-Elbow Radius and Number of Pieces: Welded construction complying with SMACNA's "HVAC Duct Construction Standards--Metal and Flexible," unless otherwise indicated.
- Round Mitered Elbows: Welded construction with the following metal thickness for pressure classes from minus 2- to plus 2-inch wg:
 - Ducts 3 to 36 Inches in Diameter: 0.034 inch.
 - 90-Degree, 2-Piece, Mitered Elbows: Use only for supply systems or for material-handling Class A or B exhaust systems and only where space restrictions do not permit using radius elbows. Fabricate with single-thickness turning vanes.
 - Round Elbows 8 Inches and Less in Diameter: Fabricate die-formed elbows for 45- and 90-degree elbows and pleated elbows for 30, 45, 60, and 90 degrees only. Fabricate nonstandard bend-angle configurations or nonstandard diameter elbows with gored construction.
 - Round Elbows 9 through 14 Inches in Diameter: Fabricate gored or pleated elbows for 30, 45, 60, and 90 degrees unless space restrictions require mitered elbows. Fabricate nonstandard bend-angle configurations or nonstandard diameter elbows with gored construction.
 - Round Elbows Larger Than 14 Inches in Diameter and All Flat-Oval Elbows: Fabricate gored elbows unless space restrictions require mitered elbows.
 - Die-Formed Elbows for Sizes through 8 Inches in Diameter and All Pressures 0.040-inch thick with 2-piece welded construction.
 - Round Gored-Elbow Metal Thickness: Same as non-elbow fittings specified above.

B.5.6 Ductwork General

- Construct Ts, bends, and elbows with radius of not less than 1-½ times width of duct on centerline. Where not possible and where rectangular elbows are used, provide turning vanes. Where acoustical lining is indicated, provide turning vanes of perforated metal with glass fiber insulation.
- Increase duct sizes gradually, not exceeding 15 degrees divergence wherever possible. Divergence upstream of equipment shall not exceed 30 degrees; convergence downstream shall not exceed 45 degrees.
- Elbows and transformation pieces, etc., shall be one to two gauges heavier, depending on size. Ratio of width individual air passages to total width of elbow shall be one to five.
- Longitudinal joints in horizontal runs or in risers shall be made with grooved seams. In elbows and transformation pieces, they shall be made with Pittsburgh corner seams or double corner seams.
- Bracing shall be galvanized steel or stainless-steel angles as applicable and conform to SMACMA recommendations and standards.
- All ductwork shall be constructed according to SMACNA and ASHRAE Specifications Standards and according to state and local code requirements. Ductwork to be sealed according to SMACNA seal Class B.

- Provide fire resistant neoprene or other approved flexible connections on the entering and leaving side of all air handling units, etc., and at the collection boxes of all roof fans, etc., or as shown on plans, equal to Ventfabric "Ventglas". Attach with metal collar frames to prevent air leakage.
- Provide flexible connection for ducts of dissimilar metals to prevent galvanic action.
- Use double nuts and lock washers on threaded rod supports.

B.6 Ductwork Accessories

B.6.1 Sheet Metal Materials

Comply with SMACNA's "HVAC Duct Construction Standards--Metal and Flexible" for acceptable materials, material thicknesses, and duct construction methods, unless otherwise indicated.

- Galvanized Sheet Steel: Lock-forming quality; complying with ASTM A 653/A 653M and having G60 coating designation; ducts shall have mill-phosphatized finish for surfaces exposed to view.
- Reinforcement Shapes and Plates: Galvanized-steel reinforcement where installed on galvanized sheet metal ducts; compatible materials for aluminum and stainless-steel ducts.
- Tie Rods: Galvanized steel, 1/4-inch minimum diameter for lengths 36 inches or less; 3/8-inch minimum diameter for lengths longer than 36 inches.

B.6.2 Flexible Connectors

Manufacturers:

- Ductmate Industries, Inc.
- Duro Dyne Corp.
- Ventfabrics, Inc.

General Description: Flame-retardant or noncombustible fabrics, coatings, and adhesives complying with UL 181, Class 1.

Metal-Edged Connectors: Factory fabricated with a fabric strip 3-1/2 inches wide attached to two strips of 2-3/4-inch- wide, 0.028-inch- thick, galvanized sheet steel or 0.032-inch- thick aluminum sheets. Select metal compatible with ducts.

Indoor System, Flexible Connector Fabric: Glass fabric double coated with neoprene.

Minimum Weight: 26 oz./sq. yd.

Tensile Strength: 480 lbf/inch in the warp and 360 lbf/inch in the filling.

Service Temperature: Minus 40 to plus 200 deg F.

B.6.3 Duct Accessory Hardware

Instrument Test Holes: Cast iron or cast aluminum to suit duct material, including screw cap and gasket. Size to allow insertion of pitot tube and other testing instruments and of length to suit duct insulation thickness.

Adhesives: High strength, quick setting, neoprene based, waterproof, and resistant to gasoline and grease.

B.7 Exhaust Fans

- Centrifugal Fan Unit: Direct driven, with steel housing, resilient mounted motor, gravity backdraft damper in discharge.
- Disconnect Switch: Factory wired, non-fusible, in housing for thermal overload protected motor.
- Controls: Wall mounted thermostat or wall switch as required per design.
- Grille: As required, molded aluminum with baked white enamel finish.
- Accessories: Provide with Wall Cap or wall louver, vibration isolation and backdraft damper.

- Provide cabinet and ceiling exhaust fans with capacities and accessories as indicated and scheduled on drawings.
- Acceptable manufacturers to be: Greenheck, Cook or Penn.

B.8 Rooftop Air Conditioning Units

B.8.1 Manufacturers: Subject to compliance with requirements, provide products by one of the following:

1. Johnson Controls
2. Trane
3. Carrier
4. JCI

B.8.2 Manufactured Units

- Casing: Double wall construction, insulated with fiberglass, stainless steel drain pan
- Supply Air Fan: Direct Drive Fan
- Condenser-Coil Fan: Propeller, permanently mounted
- Relief Air Fan: Propeller
- Motors: Premium Efficient
- Refrigerant Coil: Aluminum plated fins with copper tube
- Refrigerant: R-410A
- Gas Furnace: Stainless Steel heat exchanger, Natural gas, electronic ignition, power vent
- Filters: MERV 13 according to ASHRAE 52.2
- Power Connection: Single with unit mounted disconnect and powered convenience outlet
- Economizer: Low leak economizer with integrated fault detection and diagnostics (FDD)
- Controls: DDC controls
- Accessories: Weather hood, service lights
- Roof Curb: Neoprene gasket, 14" curb
- Construction and Ratings: According to ARI 210/240. Testing: ASHRAE 14.
- Performance Ratings: Energy Efficiency Rating (EER) not less than requirements of ANSI/ASHRAE 90A; seasonal efficiency to ANSI/ASHRAE 103. Provide units with meet or exceed the requirement of those scheduled on the drawings.
- Heating Capacity and Staging: As scheduled on plans.
- Air Handling: As scheduled on plans.
- Cooling Capacity and Staging: As scheduled on plans.

B.9 Split System Air Conditioning

B.9.1 Manufacturers

Manufacturers: Subject to compliance with requirements, provide products by one of the following:

1. Mitsubishi-Trane
2. Daikin
3. Johnson Controls
4. Carrier

B.9.2 General - Split System Cooling

Fully charged from the factory for matched indoor section and up to 15 feet of piping. Unit designed to operate at outdoor ambient temperatures as high as 115°F.

- A.R.I certified.
- UL listed.
- Exterior must be designed for outdoor application.

Description: Factory assembled and tested; consisting of casing, condenser coils, condenser fans and motors, and unit controls.

- Refrigerant: R-410A
- Performance Ratings: Energy Efficiency Rating (EER) not less than requirements of ANSI/ASHRAE 90A; seasonal efficiency to ANSI/ASHRAE 103. Provide units with meet or exceed the requirement of those scheduled on the drawings.
- Heating Capacity and Staging: As scheduled on plans.
- Air Handling: As scheduled on plans.
- Cooling Capacity and Staging: As scheduled on plans

B.9.3 Indoor Evaporator Unit- Wall Mounted

Enameled-steel cabinet, copper-tube coil, multispeed fan, washable filters. Install using factory provided wall mount. Extend condensate drain, run concealed to indirect waste receptor. Furnish and install wall mounted thermostat.

B.9.4 Split System Cooling Compressor

- Compressor to have internal over temperature and pressure protector, total dipped hermetic motor and thermostatically controlled sump heater.
- Also include roto-lock suction and discharge refrigeration connections, centrifugal oil pump, and low vibration and noise.
- Compressor to have a 5-year limited warranty.

B.9.5 Split System Cooling Condenser Coil and Fans

- The Fin coil is continuously wrapped, corrosion resistant, all copper tubes and aluminum fins with minimum brazed joints. The coil is 3/8" O.D. seam-less copper or aluminum glued to a continuous fin.
- Condensing Fans and Drives: Propeller fans with aluminum or galvanized-steel fan blades, for vertical air discharge; directly driven with permanently lubricated ball-bearing motors with integral current- and thermal-overload protection.
- Coils are lab tested to withstand 2,000 pounds of pressure per square inch. Coil to be protected on all four sides by louvered panels.
- Coil to have a 1-year warranty.

B.9.6 Split System Cooling Refrigerant Controls

- Operating and Safety Controls: Include condenser fan motor thermal and overload cutouts; 115-V control transformer, if required; magnetic contactors for condenser fan motors and a non-fused factory-mounted and -wired disconnect switch for single external electrical power connection.
- High- and low-pressure protection to be inherent to the compressor.
- Provide a factory installed liquid line drier.

B.9.7 Cooling Low Ambient and Frost Control

Provide unit with cooling capability to 25 deg. F, plus the addition of an evaporator defrost control to permit operation to 40 deg. F.

B.10 Electric Unit Heater

B.10.1 Manufacturers: Subject to compliance with requirements, provide products by one of the following:

1. Marley
2. Qmark

B.10.2 Manufactured Units

1. Casing: Standard color baked enamel finish with adjustable discharge louvers
2. Fan: Aluminum Propeller on permanently lubricated variable speed motor
3. Coil: Nickel-chromium electric resistance coil
4. Controls: Wall mounted thermostat

Performance Ratings: Energy Efficiency Rating (EER) not less than requirements of ANSI/ASHRAE 90A; seasonal efficiency to ANSI/ASHRAE 103. Provide units with meet or exceed the requirement of those scheduled on the drawings.

Heating Capacity and Staging: As scheduled on plans.

B.11 Air Curtains

B.11.1 Manufacturers: Subject to compliance with requirements, provide products by one of the following:

1. Mars air
2. Berner

B.11.2 Manufactured Units

1. Casing: Standard color baked enamel finish with adjustable discharge nozzles
2. Air Intake: Grilles
3. Fan: centrifugal with totally enclosed air over variable speed motor
4. Controls: Door switch controls and time delay
5. Filters: Washable panel type
6. Noise Criteria: Unit shall be low noise type and shall not exceed 45 NC at low speed.
7. Accessories: Installing brackets, extension neck for ceiling installations

B.12 Natural Gas Systems

B.12.1 Materials and Products

General: Provide piping materials and factory fabricated piping products of sizes, types, pressure ratings, and capacities as indicated. Where not indicated, provide proper selection as determined by Installer to comply with installation requirements. Provide materials and products complying with NFPA 54 where applicable, base pressure rating on natural gas piping system maximum design pressures. Provide sizes and types matching piping and equipment connections; provide fittings of materials that match pipe materials used in natural gas systems.

B.12.2 Basic Pipes and Pipe Fittings

Building Distribution Piping: Pipe Size 2 inches and Smaller:

1. Black steel pipe; Schedule 40, malleable iron threaded fittings.
2. 304 Stainless Steel Pipe; Schedule 40S, stainless steel threaded fittings.
3. Pipe Size 2½ inches and Larger: Black steel pipe: Schedule 40; wrought steel butt-welding fittings.

Gas Piping (Underground) – Underground piping from utility main to the Gas Meter shall be by the local gas utility. Piping from the meter into the Structure shall be considered building distribution piping.

B.12.3 Special Valves

General: Special valves required for natural gas systems include the following types:

Gas Cocks:

- Gas Cocks 2 inches and Smaller: 150 psi non-shock WOG, bronze straightway cock, flat or square head, threaded ends.
- Gas Cocks 2½ inches and Larger: 125 psi non-shock WOG, iron body bronze mounted, straightway cock, square head, flanged ends.
- Pressure Regulators: Step down pressure regulator, lock-up type staging type, reduction and capacity as required.

Manufacturer: Subject to compliance with requirements, provide gas cocks of one of the following:

- NIBCO, Inc.
- DeZurik Corporation
- Jenkins Bros.
- Lunkenheimer Company
- Rockwell International, Flow Control Division
- Stockham Valves and Fittings
- Walworth Company

C Construction

C.1 Piping Systems – Common Requirements

- Install piping indicated to be exposed and piping in equipment rooms and service areas at right angles or parallel to building walls. Diagonal runs are prohibited unless specifically indicated otherwise.
- Install piping free of sags and bends.
- Install piping to allow application of insulation.
- Select system components with pressure rating equal to or greater than system operating pressure.
- Sleeves are required for core-drilled holes.
- Install sleeves for pipes passing through concrete and masonry walls, gypsum-board partitions, and concrete floor and roof slabs.
- Cut sleeves to length for mounting flush with both surfaces.
Exception: Extend sleeves installed in floors of mechanical equipment areas or other wet areas 2 inches above finished floor level. Extend cast-iron sleeve fittings below floor slab as required to secure clamping ring if ring is specified.
- Install sleeves in new walls and slabs as new walls and slabs are constructed.
- Install sleeves that are large enough to provide 1/4-inch annular clear space between sleeve and pipe or pipe insulation. Use the following sleeve materials:
- Steel Pipe Sleeves: For pipes smaller than NPS 6.

Verify final equipment locations for roughing-in.

C.1.1 Piping Joint Construction

- Join pipe and fittings according to the following requirements.
- Ream ends of pipes and tubes and remove burrs. Bevel plain ends of steel pipe.

- Remove scale, slag, dirt, and debris from inside and outside of pipe and fittings before assembly.
- Soldered Joints: Apply ASTM B 813, water-flushable flux, unless otherwise indicated, to tube end. Construct joints according to ASTM B 828 or CDA's "Copper Tube Handbook," using lead-free solder alloy complying with ASTM B 32.
- Brazed Joints: Construct joints according to AWS's "Brazing Handbook," "Pipe and Tube" Chapter, using copper-phosphorus brazing filler metal complying with AWS A5.8.

C.1.2 Equipment Installation – Common Requirements.

- Install equipment to allow maximum possible headroom unless specific mounting heights are indicated.
- Install equipment level and plumb, parallel and perpendicular to other building systems and components in exposed interior spaces, unless otherwise indicated.
- Install mechanical equipment to facilitate service, maintenance, and repair or replacement of components. Connect equipment for ease of disconnecting, with minimum interference to other installations. Extend grease fittings to accessible locations.
- Install equipment to allow right-of-way for piping installed at required slope.

C.1.3 Painting

Damage and Touchup: Repair marred and damaged factory-painted finishes with materials and procedures to match original factory finish.

C.2 Identification and Painting - General

Where more than one type of mechanical identification is specified for listed application, selection is installer's option, but provide single selection for each product category.

Degrease and clean surfaces to receive adhesive for identification materials.

C.2.1 HVAC Systems - Labeling and Identifying

Piping Systems: Install pipe markers on each system. Include arrows showing normal direction of flow.

Plastic markers: Install on pipe insulation segment where required for hot non-insulated pipes.

Locate pipe markers wherever piping is exposed in finished spaces, equipment rooms, accessible maintenance spaces (shafts, tunnels, plenums), and exposed exterior locations as follows:

1. Near each valve and control device.
2. Near each branch, excluding short take offs for fixtures and terminal units. Mark each pipe at branch, where flow pattern is not obvious.
3. Near locations where pipes pass through walls, floors, ceilings, or enter inaccessible enclosures.
4. At access doors, manholes, and similar access points that permit view of concealed piping.
5. Near major equipment items and other points of origination and termination.
6. Spaced at a maximum of 50-foot (15 m) intervals along each run. Reduce intervals to 25 feet (7.5 m) in congested areas of piping and equipment.
7. On piping above removable acoustical ceilings, except omit intermediately spaced markers.

Equipment: Install engraved plastic laminate sign or equipment marker on or near each major item of mechanical equipment. Do not label equipment such as cabinet heaters and ceiling fans in occupied spaces.

1. Lettering Size: Minimum ¼ inch (6 mm) high lettering for name of unit where viewing distance is less than 2 feet (0.6 m), ½ inch (13 mm) high for distances up to 6 feet (1.8 m), and proportionately larger lettering for greater distances. Provide secondary lettering 1/2 to ¾ of size of principal lettering.

Text of Signs: Provide text to distinguish between multiple units, inform operator of operational requirements, indicate safety and emergency precautions, and warn of hazards and improper operations, in addition to name of identified unit.

Duct Systems: Identify air supply, return, exhaust, intake, and relief ducts with duct markers; or provide stenciled signs and arrows, showing duct system service and direction of flow.

Location: In each space where ducts are exposed or concealed by removable ceiling system, locate signs near points where ducts enter into space and at maximum intervals of 50 feet (15 m).

Adjusting: Relocate identifying devices, which become visually blocked by other work .

Painting:

Color Coding and Labeling of Piping and Equipment - The following color code shall be applied for all new piping installed as part of this project exposed to view:

1. Natural gas piping (interior) – yellow; (exterior) - grey
2. Exposed HVAC mechanical equipment hangers and supports: grey.

Protection of Finished Work and Equipment:

1. Protect with tarpaulin or drop cloth all floors, walls, glass, finished painted work, and equipment from paint spatter or other damage that might result from this Work.
2. Promptly remove all oil, paint, and solvent waste rags from the site and legally dispose of them. Do not burn waste materials.
3. Paint, varnish, and mixing cans shall not be placed on bare floors.
4. Dirty, oily, and dusty cover shall not be used.
5. No stains or spots shall remain after completion of painting. Remove hardware accessories, light fixtures, and similar items before painting.
6. Replace above items after finish coat is applied.
7. Masking may be utilized in lieu of removal of items.

Application:

1. Application may be by brushing or rolling. Method used shall be one as approved by material manufacturer for any one particular product.
2. Brushing: Brush in one direction then smooth at right angles to original brushing to produce a uniform thickness of coating.
3. Thickness of Coating: Where number of coats is indicated, it is intended to show the normal practice to obtain the proper dry mil thickness.
4. The dry mil film thickness must be provided in all cases even though it may require additional coatings to that specified. Contractor must provide adequate ventilation at all times.

Ventilation shall be adequate to remove fumes, preventing injury to workmen, or possibility of accumulating volatile gases.

C.3 HVAC Ductwork Insulation

C.3.1 Preparation

C.3.1.1 Surface Preparation

Clean, dry, and remove foreign materials such as rust, scale, and dirt.

Mix insulating cements with clean potable water. Mix insulating cements contacting stainless steel surfaces with demineralized water.

C.3.2 Installation

Refer to schedules at the end of this section for materials, forms, jackets, and thicknesses required for each ductwork system.

Select accessories compatible with materials suitable for the service. Select accessories that do not corrode, soften, or otherwise attack the insulation or jacket in either the wet or dry state.

Install vapor barriers on insulated ducts having surface operating temperatures below 60°F.

Install insulation, accessories and finishes according to the latest edition of MCI National Commercial and Industrial Insulation Standards and manufacturer's installation instructions. Exceptions to these standards will be accepted where specifically modified in these specifications or where prior written approval has been obtained from the engineer.

Install insulation with smooth, straight, and even surfaces.

Seal joints and seams to maintain vapor barrier on insulation requiring a vapor barrier.

Seal penetrations for hangers, supports, anchors, and other projections in insulation requiring a vapor barrier.

C.3.2.1 Seal Ends

Except for flexible elastomeric insulation, taper ends at 45 deg angle and seal with lagging adhesive. Cut ends of flexible elastomeric cellular insulation square and seal with adhesive.

Apply adhesives and coatings at manufacturer's recommended coverage per gallon rate.

Keep insulation materials dry during application and finishing.

Items Not Insulated: Unless otherwise indicated do not apply insulation to the following systems, materials, and equipment:

- Factory insulated flexible ducts.
- Flexible connectors.
- Testing laboratory labels and stamps.
- Access panels and doors in air distribution systems.

Install block and board insulation as follows:

Speed Washers Attachment: Secure insulation tight and smooth with speed washers and welded pins. Space anchor pins 18 inches apart each way and 3 inches from insulation joints. Apply vapor barrier tape to seal insulation in contact, open joints, breaks, punctures, and voids in insulation.

Blanket Insulation: Install tight and smooth. Secure to ducts having long sides or diameters as follows:

1. Smaller than 24 Inches: Bonding adhesive applied in 6-inch wide transverse strips on 12-inch centers.
2. Overlap joints 3 inches.
3. Seal joints, breaks, and punctures with vapor barrier tape.
4. At test plugs, provide removable insulation plugs.
5. Insulate around damper operators so as to maintain full operating range of operator.

C.3.3 Ductwork Insulation Schedule

First 6' of exhaust duct and outside air duct from building envelop Penetration.

1. Material: Glass fiber board round or rectangular as required.
2. Thickness 1/1/2"
3. Jacket: Provide with factory FSK jacket.

Supply air duct concealed above Ceiling:

1. Material: Glass fiber board round or rectangular as required.
2. Thickness: 1/1/2"
3. Jacket: Provide with factory FSK jacket.

C.4 Refrigeration Piping and Specialties Installation

C.4.1 Preparation

Ream pipe and tube ends. Remove burrs.

Remove scale and dirt on inside and outside before assembly.

Prepare piping connections to equipment with flanges or unions.

C.4.2 Installation

- Install refrigeration specialties according to manufacturer's instructions.
- Route piping in orderly manner, with plumbing parallel to building structure, and maintain gradient.
- Install piping to conserve building space and not interfere with use of space.
- Group piping whenever practical at common elevations and locations. Slope piping one percent in direction of oil return.
- Provide non-conducting dielectric connections when joining dissimilar metals.
- Install piping to allow for expansion and contraction without stressing pipe, joints, or connected equipment.
- Provide clearance for installation of insulation and access fittings.
- Provide access to concealed fittings.
- Where pipe support members are welded to structural building frame, brush clean and apply one coat of zinc rich primer to welding.
- Prepare pipe, fittings, supports, and accessories not prefinished, ready for finish painting.
- Insulate piping per insulation manufacturers recommendations. All insulation exposed to sunlight or installed outdoors shall be protected with two coats of WB Armaflex Finish or weather resistant coating.
- Fully charge completed system with refrigerant after testing.
- Provide refrigerant charging valve connections in liquid line between receiver shut off valve and expansion valve.

C.4.3 Field Quality Control

Test refrigeration system according to ANSI/ASME B31.5.

Pressure test system with dry nitrogen to 200 psig. Perform final tests at 27 inches vacuum and 200 psig using halide torch electronic leak detector. Test to no leakage.

C.5 Ductwork Installation

- Provide openings in ductwork where required to accommodate thermometers and controllers. Provide pilot tube openings where required for testing of systems, complete with metal can with spring device or screw to ensure against air leakage. Where openings are provided in insulated ductwork, install insulation material inside a metal ring.
- Locate ducts with sufficient space around equipment to allow normal operating and maintenance activities.
- Suspended horizontal ductwork shall be securely and rigidly anchored and supported from the building structure by means of rod-angle iron or strap iron hangers. Rod hangers shall be threaded at both ends and equipped with nuts and washers. Angle and strap hangers shall be attached to ducts by means of welds or sheet metal screws or by rivets. They shall be attached to suitable roof or ceiling structures through formed angles, by anchor screws and heavy, wide washers. If attached to floor slab, the bearing quality of slab material shall be checked and found capable of supporting weight of duct.

- Vertical dust risers shall be rigidly supported as they pass through floors, ceilings or roofs by angle iron spanning the opening and firmly and securely attached to the building walls or columns. All ductwork shall be so installed as to be free from vibration under all normal operating conditions. Where required, suitable sound attenuators shall be incorporated with the anchors and/or supports. Finish openings in floors, walls and ceilings with 22-gauge sheet metal closures to give a neat appearance.
- Where ducts pass through walls or floors, provide a suitable sheet metal angle around the periphery of the duct. Where ducts pass through exterior building construction, provide a suitable flashing and counterflashing to make a weathertight installation.
- Where external insulated ducts pass through walls, floors or ceilings, suitable size openings shall be made to allow for the insulation through the opening. The insulation shall not be stopped on each side of the opening.
- Connect diffusers to low pressure ducts with 5 feet maximum length of flexible duct. Hold in place with strap or clamp.

C.5.1 Field Quality Control

- Perform the following field tests and inspections according to SMACNA's "HVAC Air Duct Leakage Test Manual". Provide evidence of compliance upon request.
- Disassemble, reassemble, and seal segments of systems to accommodate leakage testing and for compliance with test requirements.
- Conduct tests at static pressures equal to maximum design pressure of system or section being tested. If pressure classes are not indicated, test entire system at maximum system design pressure. Do not pressurize systems above maximum design operating pressure.
- Maximum Allowable Leakage: Comply with requirements for Leakage Class 3 for round and flat-oval ducts, Leakage Class 12 for rectangular ducts in pressure classes lower than and equal to 2-inch wg (both positive and negative pressures), and Leakage Class 6 for pressure classes from 2- to 10-inch wg.
- Remake leaking joints and retest until leakage is equal to or less than maximum allowable.

C.5.2 Adjusting and Cleaning

Clean duct system and force air at high velocity through duct to remove accumulated dust. To obtain sufficient air, clean half the system at a time. Protect equipment, which may be harmed by excessive dirt with temporary filters, or bypass during cleaning.

C.6 Application and Installation of Ductwork Accessories

- Install duct accessories according to applicable details in SMACNA's "HVAC Duct Construction Standards-Metal and Flexible" for metal ducts
- Provide duct accessories of materials suited to duct materials; use galvanized-steel accessories in galvanized ducts
- Install flexible connectors immediately adjacent to equipment in ducts associated with fans and motorized equipment supported by vibration isolators.
- Install duct test holes where indicated and required for testing and balancing purposes.

C.6.1 Adjusting

Adjust duct accessories for proper settings.

Final positioning of manual-volume dampers is specified in "Testing, Adjusting, and Balancing" work description.

C.7 Exhaust Fan Installation

- Install according to manufacturer's instructions.
- Coordinate all wall openings required with general contractor.

- Support fan and fan housings utilizing neoprene isolators at all hanging points. Coordinate supports and support anchoring placement with general contractor.
- Coordinate electrical requirements. Final electrical connections shall conform to Project Electrical requirements. Properly ground equipment. Coordinate the mounting and power wiring of fans with manufacturer's recommendations.

C.8 Rooftop Unit installation

C.8.1 General

Coordinate roof curb locations and sizes.

Verify pressure of natural gas to furnace. Install stepdown regulator if required.

C.8.2 Examination

- Verify that roof curbs are ready for installation of units and openings are as indicated on shop drawings.
- Verify that proper power supply is available for rooftop unit.
- Verify that proper gas supply is available for connection.

C.8.3 Installation

- Install according to manufacturer's instructions.
- Install condensate drain lines from rooftop unit to roof drain as shown on plans. Pipe condensate utilizing Schedule 40 PVC drain piping.
- Install interconnecting control wiring between thermostat and rooftop unit.
- Install to NFPA 90A, ANSI/NFPA 90B and ANSI Z223.1 (NFPA 54).

C.8.4 Connections

- Ductwork and piping installation requirements are specified herein. Drawings indicate general arrangement of ductwork, piping, fittings, and specialties.
- Install ductwork connections as indicated on drawings.
- Install piping adjacent to machine to allow service and maintenance.
- Ground equipment according to electrical requirements of this project.
- Connect wiring according to electrical requirements of this project.

C.8.5 Field Quality Control

Perform the following field tests and inspections and prepare test reports:

- Perform electrical test and visual and mechanical inspection.
- Operational Test: After electrical circuitry has been energized, start units to confirm proper motor rotation and unit operation. Complete manufacturer's starting checklist.
- Test and adjust controls and safeties. Replace damaged and malfunctioning controls and equipment.
- Verify proper airflow over coils.

Remove and replace malfunctioning units and retest as specified above.

C.9 Indoor Evaporator Unit Installation

C.9.1 General

Coordinate locations, wall brackets and power connections

C.9.2 Examination

- Verify that wall brackets are ready for installation of units and openings are as indicated on shop drawings.
- Verify that proper power supply is available for unit.
- Verify that proper drain piping is available.

C.9.3 Installation

- Install according to manufacturer's instructions.
- Install refrigerant lines from indoor equipment to outdoor condensing units. Insulate as required and recommended by manufacturer. Refrigerant lines are to be insulated.
- Install condensate drain lines from DX Coil to Condensate Pump. as shown on plans. Pipe condensate utilizing Schedule 40 PVC drain piping.
- Install interconnecting control wiring between thermostat, evaporator and air-cooled condensing unit.
- Install to NFPA 90A and ANSI/NFPA 90B.

C.10 Unit Heater

C.10.1 General

Coordinate locations, brackets and power connections

C.10.2 Examination

Verify that wall brackets are ready for installation of units and openings are as indicated on shop drawings.

Verify that proper power supply is available for unit.

C.10.3 Installation

Install according to manufacturer's instructions.

Install interconnecting control wiring between thermostat and unit heater.

Install to NFPA 90A and ANSI/NFPA 90B.

C.11 Air-Cooled Condensing Unit installation

C.11.1 Examination

Examine substrates, areas, and conditions, with Installer present, for compliance with requirements for installation tolerances and other conditions affecting performance of air-cooled condensers.

Examine roughing-in for refrigerant piping systems to verify actual locations of piping connections before equipment installation.

Proceed with installation only after unsatisfactory conditions have been corrected.

C.11.2 Installation

Install unit(s) level and plumb, firmly anchored in locations indicated; maintain manufacturer's recommended clearances.

Install air-cooled condensers on concrete base.

Maintain manufacturer's recommended clearances for service and maintenance.

Loose Components: Install electrical components, devices, and accessories that are not factory mounted.

C.11.3 Connections

Piping installation requirements are specified herein. Drawings indicate general arrangement of piping, fittings, and specialties.

Install piping adjacent to machine to allow service and maintenance.

Refrigerant Piping: Connect piping to unit with pressure relief, service valve, filter-dryer, and moisture indicator on each refrigerant-circuit liquid line.

Ground equipment according to electrical requirements of this project.

Connect wiring according to electrical requirements of this project.

C.11.4 Field Quality Control

Perform the following field tests and inspections and prepare test reports:

- Perform electrical test and visual and mechanical inspection.
- Leak Test: After installation, charge system and test for leaks. Repair leaks and retest until no leaks exist.
- Operational Test: After electrical circuitry has been energized, start units to confirm proper motor rotation and unit operation. Complete manufacturer's starting checklist.
- Test and adjust controls and safeties. Replace damaged and malfunctioning controls and equipment.
- Verify proper airflow over coils.

Remove and replace malfunctioning air-cooled condensers and retest as specified above.

C.11.5 Startup Service

Complete installation and startup checks according to manufacturer's written instructions and perform the following:

- Inspect for physical damage to unit casing.
- Verify that access doors move freely and are weathertight.
- Clean units and inspect for construction debris.
- Verify that all bolts and screws are tight.
- Verify that controls are connected and operational.
- Lubricate bearings on fans.
- Verify that fan wheel is rotating in the correct direction and is not vibrating or binding.
- Start unit according to manufacturer's written instructions and complete manufacturer's startup checklist.
- Verify proper operation of capacity control device.
- After startup and performance test, lubricate bearings.

C.12 Natural Gas System Installation

C.12.1 Summary

Extent of work is limited to piping and accessories as required to extend natural gas line from meter to gas fired equipment as indicated on drawings and schedules as required by this section.

Contractor to verify gas pressure available with local natural gas utility and to provide piping system including gas pressure step down regulators as may be needed.

C.12.2 Installation of Natural Gas Piping

- Use sealants on metal gas piping threads that are chemically resistant to natural gas. Use sealants sparingly and apply to only male threads of metal joints.
- Remove cutting and threading burrs before assembling piping.
- Do not install defective piping or fittings. Do not use pipe with threads that are chipped, stripped or damaged.

- Plug each gas outlet, including valves, with threaded plug or cap immediately after installation and retain until continuing piping, or equipment connections are completed.
- Install drip legs in gas piping where indicated, and where required by code or regulation.
- Install "tee" fittings with bottom outlet plugged or capped, at bottom of pipe risers.
- Install piping with 1/64 inch per foot downward slope in direction of flow.
- Install piping parallel to other piping, but maintain minimum of 12-inch clearance between gas piping and steam or hydronic piping above 200 deg F.
- Install gas pressure regulator at equipment. Size for pressure leaving meter, required pressure at equipment and required flow. Vent per code to atmosphere. NOTE: Coordinate gas pressures provided and placement of step-down regulators where they may be required.
- All pipe supports to be spaced a maximum of 5 feet.

C.12.3 Natural Gas Service

General: Coordinate with local gas utility company the connection of new loads to the existing natural gas service.

- Coordinate available gas pressure and gas load the new service.
- Coordinate with the utility the location of the new gas service.
- Consult with utility as to extent of its work, costs, and fees associated with any service size increases or modifications. Pay such costs and fees.
- Verify pressure leaving the meter. Gas piping distribution system was sized based on the indicated pressure leaving the meter or at the building structure as shown on the plans. If needed modify the gas pipe size based on actual pressures being provided.

Provide step down gas regulators as required at each structure and as may be needed at each natural gas burning device/equipment.

C.12.4 Installation of Natural Gas Piping Specialties

Do not conceal any gas piping or specialties.

C.12.5 Installation of Valves

Gas Cocks: Provide at connection to gas train for each gas fired equipment item and on risers and branches where indicated.

Locate gas cocks where easily accessible, and where they will be protected from possible injury.

C.12.6 Equipment Connections

General: Connect gas piping to each gas fired equipment item with drip leg and shutoff gas cock.

Comply with equipment manufacturer's instructions.

Install any required step-down pressure regulators that may be required based on gas pressures supplied from gas meter to gas pressure requirements of equipment. Pipe any regulator vents to outside of building away from any O.A. intakes.

C.12.7 Field Quality Control

Piping Tests: Inspect, test, and purge natural gas systems according to NFPA 54.

C.12.8 Adjusting, Cleaning and Painting

Cleaning and Inspecting: Clean and inspect natural gas systems. Paint gas piping per this SPV, paragraph C.2.2.

C.13 HVAC Testing and Balancing

This Section includes TAB to produce design objectives for the following:

- Supply air, return and exhaust air duct distribution system.
- Exhaust fans
- HVAC equipment quantitative-performance settings.
- Test and Verify that automatic control devices function properly and that interlocks work.

Reporting results of activities and procedures specified in this Section.

C.14 TAB Submittals

Certified TAB Reports: Submit two copies of reports prepared, as specified in this Section, on approved forms certified by TAB firm.

D Measurement

The department will measure HVAC Work as a single unit of work for each contract, acceptably completed.

E Payment

The department will pay for measured quantities at the contract unit price under the following bid item:

ITEM NUMBER	DESCRIPTION	UNIT
SPV. 0060.17	HVAC Work	EACH

Payment is full compensation for furnishing all labor, tools, equipment, materials, and incidentals necessary to complete the contract work.

38. Lighting, Item SPV. 0060.18.

A Description

This special provision describes furnishing materials necessary for the installation, testing, and making fully operational the lighting components and systems for the structure. All additional special provisions provide further information, requirements, and guidelines that are applicable to the work paid for under the bid items addressed by this special provision.

Comply with all local codes, all laws applying to electrical installations in effect, the regulations of the latest National Electrical and energy codes.

It is the intention of the contract plans to call for completely finished work, fully tested and ready for reliable and consistent operation. Furnish, deliver, and install any apparatus, appliance, materials, or work not shown on the plans but mentioned in the special provisions or vice versa, or any incidental accessories necessary to make the work complete in all respects and ready for operation, to be furnished, delivered, and installed without additional expense to the department.

B Materials

B.1 Lighting Control Devices

B.1.1 Products

1. Time Switches: Electronic, programmable units.
2. Outdoor Photoelectric Switches: Solid state, with dry contacts, 15-second time delay, and metal-oxide varistor surge protection.
3. Daylight-harvesting switching controls.
4. Daylight-harvesting dimming controls.

5. Indoor Occupancy Sensors:
 - a. Solid-state indoor vacancy sensors.
 - b. Dual technology.
 - c. Separate power pack.
6. Switchbox-mounted occupancy sensors: Wall-switch sensor with manual on-off switch, single gang switchbox mount, with provisions for connection to BAS using hardwired connection.
7. Digital timer light switch.
8. High-bay occupancy sensors.
9. Extreme-temperature occupancy sensors.
10. Lighting Contactors: Electrically operated and mechanically held and interface to connect to BAS.
11. Emergency Shunt Relay: Normally closed, electrically held, arranged for wiring in parallel with manual or automatic switching contacts.
12. Control Cables:
 - a. Power Cables: Not smaller than No. 12 AWG.
 - b. Class 2 and 3 Control Cables: Stranded-copper conductors, not smaller than No. 18 AWG.
 - c. Class 1 Control Cables: Stranded-copper conductors, not smaller than No. 14 AWG.

B.2 LED Interior Lighting

B.2.1 Warranty

1. Materials and Workmanship for Luminaires: Five years.

B.2.2 Products

1. Operating Nominal Voltage: 120 V - 277 V ac.
2. Luminaire Types:
 - a. Cylinder.
 - b. Downlight.
 - c. Linear, industrial.
 - d. Recessed linear.
 - e. Surface mount, linear.
 - f. Suspended, linear.
3. Luminaire Requirements
 - a. Electrical Components, Devices, and Accessories: Listed and labeled as defined in NFPA 70.
 - b. Factory-Applied Labels: Comply with UL 1598.
 - c. Recessed luminaires shall comply with NEMA LE 4.
 - d. NRTL Compliance: Luminaires for hazardous locations shall be listed and labeled for indicated class and division of hazard.
 - e. Minimum allowable efficacy of 80 lumens per watt.
 - f. CRI of minimum 80. CCT of 4000K.
4. Provide an additional two fixtures of each fixture type for building stock purposes.

B.2.3 Materials

1. Housings:
 - a. Extruded-aluminum housing and heat sink.
 - b. Clear anodized finish.
2. Factory-applied labels: Labels shall include the following lamp characteristics:
 - a. "USE ONLY" and include specific lamp type.
 - b. Lamp diameter, shape, size, wattage, and coating.
 - c. CCT and CRI for all luminaires.
3. Luminaire Support:
 - a. Single-Stem Hangers: Steel tubing with swivel ball fittings and ceiling canopy.
 - b. Wires: Soft temper, zinc-coated steel, 12 gage.
 - c. Rod Hangers: Cadmium-plated, threaded steel rod.
 - d. Hook Hangers: Integrated assembly matched to luminaire, line voltage, and equipment with threaded attachment, cord, and locking-type plug.

B.3 LED Exterior Lighting

B.3.1 Warranty

1. Materials and Workmanship for Luminaires: Two years.

B.3.2 Products

1. CRI of minimum 70. CCT of 4000 K.
2. L70 lamp life of 35,000 hours.
3. Operating Voltage: 120 V ac-277 V ac.
4. Luminaire Certification: Design Lights Consortium.
5. Luminaire Types:
 - a. Area.
 - b. Canopy.
 - c. Decorative post top.
6. Provide an additional two fixtures of each fixture type for building stock purposes.

B.4 Emergency and Exit Lighting

B.4.1 Warranty

1. Materials and Workmanship for Luminaires and Emergency Lighting Batteries: Two years.

B.4.2 General Requirements For Emergency Lighting

1. Internal Type: Self-contained, modular, battery-inverter unit, factory mounted within luminaire body and compatible with ballast.
 - a. Emergency Connection: Operate one lamp(s) continuously at an output of 1100 minimum lumens each upon loss of normal power.
 - b. Automatically operating relay.
 - c. Nightlight connection to operate lamp continuously at 40 percent minimum of rated light output.
 - d. Test push-button and indicator light.
 - e. Sealed, maintenance-free, nickel-cadmium battery.

- f. Fully automatic, solid-state, constant-current charger.
 - g. Remote test switch.
 - h. Automatic, integral self-test electronic device.
2. External Type: Self-contained, modular, battery-inverter unit, suitable for powering one or more lamps, remote mounted from luminaire.
- a. Emergency Connection: Operate one lamp(s) continuously at an output of 1100 minimum lumens each upon loss of normal power.
 - b. Automatically operating relay.
 - c. Nightlight connection to operate lamp continuously at 40 percent minimum of rated light output.
 - d. Sealed, maintenance-free, nickel-cadmium battery.
 - e. Fully automatic, solid-state, constant-current charger.
 - f. Test push-button and indicator light.
 - g. Remote test switch.
 - h. Automatic, integral self-test electronic device.

B.4.3 Emergency Lighting

- 1. System Description: Self-contained emergency lighting assemblies.
- 2. Emergency Luminaires:
 - a. Internal emergency power unit.
 - b. Operating at nominal voltage of 120 V ac-277 V ac.
 - c. Rated for installation in damp locations and for sealed and gasketed fixtures in wet locations.
- 3. Emergency Lighting Unit:
 - a. Operating at nominal voltage of 120 V ac-277 V ac
 - b. Wall with universal junction box adaptor.
 - c. UV stable thermoplastic housing rated for damp locations.
 - d. Two LED lamp heads.
 - e. Internal emergency power unit.

B.4.4 Exit Signs

- 1. System Description: Exit Signs.
 - a. Internally Lighted Signs:
 - i. Operating at nominal voltage of 120 V ac-277 V ac.
 - ii. Lamps for AC Operation: LED; 20,000 hours of rated lamp life.
 - iii. Self-powered exit signs with internal emergency power unit.

B.4.5 Materials

- 1. Housings:
 - a. Extruded aluminum housing and heat sink.
 - b. Clear anodized finish.
- 2. Batteries: Nickel cadmium.
- 3. Lamps: LED.

C Construction

D Measurement

The department will measure Lighting as a single unit for each project, acceptably completed.

E Payment

The department will pay for measured quantities at the contract unit price under the following bid item:

ITEM NUMBER	DESCRIPTION	UNIT
SPV. 0060.18	Lighting	EACH

Payment is full compensation for furnishing and installing lighting.

39. General Electrical Work, Item SPV.0060.19.

A Description

This special provision describes furnishing materials necessary for the installation, testing, and making fully operational the basic electrical components and systems for the structure. All additional special provisions provide further information, requirements, and guidelines that are applicable to the work paid for under the bid items addressed by this special provision.

Comply with all local codes, all laws applying to electrical installations in effect, the regulations of the latest National Electrical Code, where such regulations do not conflict with the laws in effect and with the requirements of the utility company.

It is the intention of the contract plans to call for completely finished work, fully tested and ready for reliable and consistent operation. Furnish, deliver, and install any apparatus, appliance, materials, or work not shown on the plans but mentioned in the special provisions or vice versa, or any incidental accessories necessary to make the work complete in all respects and ready for operation, to be furnished, delivered, and installed without additional expense to the department.

All materials shall comply with Buy America Act.

B Materials

B.1 Low-Voltage Electrical Power Conductors and Cables

B.1.1 Conductors and Cables

1. Copper Building Wire, Rated 600 V or Less:
 - a. Insulation: Type THHN/THWN.
2. Metal-Clad Cable, Type MC:
 - a. Conductor: Copper.
3. Mineral-insulated cable, Type MI.
4. Fire-Alarm Wire and Cable: Complying with NFPA 70, Article 760.
 - a. Signaling Line Circuits: Twisted, shielded pair.
 - b. Non-Power-Limited Circuits: Solid-copper conductors, 600 V, 75 deg C.
 - i Low-Voltage Circuits: No. 16 AWG, minimum.
 - ii Line-Voltage Circuits: No. 12 AWG, minimum.
 - iii Multiconductor Armored Cable: Type MC.

- c. Consolidation Points:
 - i Number of Connectors per Field: One for each four-pair conductor group of indicated cables.
 - ii Mounting: Recessed in ceiling.
- d. Cable Management System: Computer-based cable management system, with integrated database capabilities.

B.1.2 Conductor Material Applications

- 1. Feeders: Copper. Solid for No. 10 AWG and smaller; stranded for No. 8 AWG and larger.
- 2. Branch Circuits: Copper. Solid for No. 10 AWG and smaller; stranded for No. 8 AWG and larger.

B.1.3 Conductor Insulation And Multiconductor Cable Applications And Wiring Methods

- 1. Service Entrance: Type XHHW-2, single conductors in raceway.
- 2. Exposed Feeders: Type THHN/THWN-2, single conductors in raceway.
- 3. Feeders Concealed in Ceilings, Walls, Partitions, and Crawlspace: Type THHN/THWN-2, single conductors in raceway.
- 4. Feeders Concealed in Concrete, below Slabs-on-Grade, and Underground: Type XHHW-2, single conductors in raceway.
- 5. Exposed Branch Circuits, Including in Crawlspace: Type THHN/THWN-2, single conductors in raceway.
- 6. Branch Circuits Concealed in Ceilings, Walls, and Partitions: Type THHN/THWN-2, single conductors in raceway or Metal-clad cable, Type MC (if approved by Owner).
- 7. Branch Circuits Concealed in Concrete, below Slabs-on-Grade, and Underground: Type XHHW-2, single conductors in raceway.

B.1.4 Field Quality Control

- 1. Testing Agency: Contractor.
- 2. Infrared Scanning: For each splice in cables and conductors No. 3 AWG and larger.

B.2 Grounding and Bonding for Electrical Systems

B.2.1 General

- 1. Summary
 - a. Section includes grounding and bonding systems and equipment.
- 2. Action Submittals
 - a. Product Data: For grounding equipment.

B.2.2 Products

- 1. Manufacturers
 - a. Erico, Thomas & Betts, TE Connectivity or approved equal
- 2. System Description
 - a. Electrical Components, Devices, and Accessories: Listed and labeled as defined in NFPA 70, by a qualified testing agency, and marked for intended location and application.
 - b. Comply with UL 467 for grounding and bonding materials and equipment.
- 3. Conductors
 - a. Insulated Conductors: Copper wire or cable insulated for 600 V unless otherwise required by applicable Code or authorities having jurisdiction.

- b. Bare Copper Conductors:
 - i Solid Conductors: ASTM B 3.
 - ii Stranded Conductors: ASTM B 8.
 - iii Tinned Conductors: ASTM B 33.
 - iv Bonding Cable: 28 kcmil, 14 strands of No. 17 AWG conductor, 1/4 inch in diameter.
 - v Bonding Conductor: No. 4 or No. 6 AWG, stranded conductor.
 - vi Bonding Jumper: Copper tape, braided conductors terminated with copper ferrules; 1-5/8 inches wide and 1/16 inch thick.
 - vii Tinned Bonding Jumper: Tinned-copper tape, braided conductors terminated with copper ferrules; 1-5/8 inches wide and 1/16 inch thick.
- 4. Connectors
 - a. Listed and labeled by an NRTL acceptable to authorities having jurisdiction for applications in which used and for specific types, sizes, and combinations of conductors and other items connected.
 - b. Bolted Connectors for Conductors and Pipes: Copper or copper alloy.
 - c. Welded Connectors: Exothermic-welding kits of types recommended by kit manufacturer for materials being joined and installation conditions.
 - d. Bus-Bar Connectors: Mechanical type, cast silicon bronze, solderless compression-type wire terminals, and long-barrel, two-bolt connection to ground bus bar.
- 5. Grounding Electrodes
 - a. Ground Rods: Copper-clad steel; 5/8 inch by 12 feet.

C Construction

C.1 Applications

- 1. Conductors: Install solid conductor for No. 8 AWG and smaller, and stranded conductors for No. 6 AWG and larger unless otherwise indicated.
- 2. Underground Grounding Conductors: Install bare tinned-copper conductor, No. 2/0 AWG minimum.
 - a. Bury at least 24 inches below grade.
- 3. Conductor Terminations and Connections:
 - a. Pipe and Equipment Grounding Conductor Terminations: Bolted connectors.
 - b. Underground Connections: Welded connectors except at test wells and as otherwise indicated.
 - c. Connections to Ground Rods at Test Wells: Bolted connectors.
 - d. Connections to Structural Steel: Welded connectors.

C.2 Grounding at the Service

- 1. Equipment grounding conductors and grounding electrode conductors shall be connected to the ground bus. Install a main bonding jumper between the neutral and ground buses.
- 2. Ground resistance testing: Service ground shall be tested. If resistance to ground exceeds 5 Ohms, notify Owner and provide recommendations to reduce ground resistance, such as installing additional ground rods.

C.3 Grounding Underground Distribution System Components

1. Comply with IEEE C2 grounding requirements.
2. Grounding Manholes and Handholes: Install a driven ground rod through manhole or handhole floor, close to wall, and set rod depth so 4 inches will extend above finished floor. If necessary, install ground rod before manhole is placed and provide No. 1/0 AWG bare, tinned-copper conductor from ground rod into manhole through a waterproof sleeve in manhole wall. Protect ground rods passing through concrete floor with a double wrapping of pressure-sensitive insulating tape or heat-shrunk insulating sleeve from 2 inches above to 6 inches below concrete. Seal floor opening with waterproof, nonshrink grout.
3. Grounding Connections to Manhole Components: Bond exposed-metal parts such as inserts, cable racks, pulling irons, ladders, and cable shields within each manhole or handhole, to ground rod or grounding conductor. Make connections with No. 4 AWG minimum, stranded, hard-drawn copper bonding conductor. Train conductors level or plumb around corners and fasten to manhole walls. Connect to cable armor and cable shields according to written instructions by manufacturer of splicing and termination kits.
4. Pad-Mounted Transformers and Switches: Install two ground rods around the pad. Ground pad-mounted equipment and noncurrent-carrying metal items associated with substations by connecting them to underground cable and grounding electrodes. Install tinned-copper conductor not less than No. 2 AWG for taps to equipment grounding terminals.

C.4 Equipment Grounding

1. Install insulated equipment grounding conductors with all feeders and branch circuits.
2. Install insulated equipment grounding conductors with the following items, in addition to those required by NFPA 70:
 - a. Feeders and branch circuits.
 - b. Lighting circuits.
 - c. Receptacle circuits.
 - d. Single-phase motor and appliance branch circuits.
 - e. Three-phase motor and appliance branch circuits.
 - f. Flexible raceway runs.
 - g. Armored and metal-clad cable runs.
 - h. Busway Supply Circuits: Install insulated equipment grounding conductor from grounding bus in the switchgear, switchboard, or distribution panel to equipment grounding bar terminal on busway.
3. Air-Duct Equipment Circuits: Install insulated equipment grounding conductor to duct-mounted electrical devices operating at 120 V and more, including air cleaners, heaters, dampers, humidifiers, and other duct electrical equipment. Bond conductor to each unit and to air duct and connected metallic piping.
4. Water Heater, Heat-Tracing, and Anti-frost Heating Cables: Install a separate insulated equipment grounding conductor to each electric water heater and heat-tracing cable. Bond conductor to heater units, piping, connected equipment, and components.
5. Poles Supporting Outdoor Lighting Fixtures: Install grounding electrode and a separate insulated equipment grounding conductor in addition to grounding conductor installed with branch-circuit conductors.
6. Metallic Fences: Comply with requirements of IEEE C2.
 - a. Grounding Conductor: Bare tinned copper, not less than No. 8 AWG.
 - b. Gates: Shall be bonded to the grounding conductor with a flexible bonding jumper.

C.5 Installation

1. **Grounding Conductors:** Route along shortest and straightest paths possible unless otherwise indicated or required by Code. Avoid obstructing access or placing conductors where they may be subjected to strain, impact, or damage.
2. **Ground Bonding Common with Lightning Protection System:** Comply with NFPA 780 and UL 96 when interconnecting with lightning protection system. Bond electrical power system ground directly to lightning protection system grounding conductor at closest point to electrical service grounding electrode. Use bonding conductor sized same as system grounding electrode conductor and install in conduit.
3. **Ground Rods:** Drive rods until tops are 2 inches below finished floor or final grade unless otherwise indicated.
 - a. Interconnect ground rods with grounding electrode conductor below grade and as otherwise indicated. Make connections without exposing steel or damaging coating if any.
 - b. For grounding electrode system, install at least three rods spaced at least one-rod length from each other and located at least the same distance from other grounding electrodes, and connect to the service grounding electrode conductor.
4. **Test Wells:** Ground rod driven through drilled hole in bottom of handhole. Handholes are specified in Section "Underground Ducts and Raceways for Electrical Systems," and shall be at least 12 inches deep, with cover.
 - a. **Test Wells:** Install at least one test well for each service unless otherwise indicated. Install at the ground rod electrically closest to service entrance. Set top of test well flush with finished grade or floor.
 - b. **Bonding Straps and Jumpers:** Install in locations accessible for inspection and maintenance except where routed through short lengths of conduit.
 - c. **Bonding to Structure:** Bond straps directly to basic structure, taking care not to penetrate any adjacent parts.
 - d. **Bonding to Equipment Mounted on Vibration Isolation Hangers and Supports:** Install bonding so vibration is not transmitted to rigidly mounted equipment.
 - e. Use exothermic-welded connectors for outdoor locations; if a disconnect-type connection is required, use a bolted clamp.
5. **Grounding and Bonding for Piping:**
 - a. **Metal Water Service Pipe:** Install insulated copper grounding conductors, in conduit, from building's main service equipment, or grounding bus, to main metal water service entrances to building. Connect grounding conductors to main metal water service pipes; use a bolted clamp connector or bolt a lug-type connector to a pipe flange by using one of the lug bolts of the flange. Where a dielectric main water fitting is installed, connect grounding conductor on street side of fitting. Bond metal grounding conductor conduit or sleeve to conductor at each end.
 - b. **Water Meter Piping:** Use braided-type bonding jumpers to electrically bypass water meters. Connect to pipe with a bolted connector.
 - c. Bond each aboveground portion of gas piping system downstream from equipment shutoff valve.

C.6 Field Quality Control

1. Perform tests and inspections. Inspect physical and mechanical condition. Verify tightness of accessible, bolted, electrical connections with a calibrated torque wrench according to manufacturer's written instructions.

C.7 Hangers and Supports for Electrical Systems

C.7.1 Products

1. Support, Anchorage, and Attachment Components:
 - a. Galvanized-steel slotted support systems with metallic coatings.
 - b. Aluminum slotted support systems with nonmetallic coatings.
 - c. Nonmetallic slotted support systems.
 - d. Raceways and cable supports.
 - e. Steel conduits and cable hangers, clamps, and associated accessories.
 - f. Support for nonarmored conductors and cables in vertical conduit risers.
 - g. Structural steel for fabricated supports and restraints.
 - h. Mounting, Anchoring, and Attachment Components:
 - i Powder-actuated fasteners.
 - ii Mechanical-expansion anchors.
 - iii Concrete inserts.
 - iv Clamps for attachment to steel structural elements.
 - v Steel springhead toggle bolts.
 - vi Threaded hanger rods.
2. Fabricated Metal Equipment Support Assemblies: Welded or bolted steel shapes.
3. Concrete Bases: 3000-psi, 28-day compressive-strength concrete.

C.8 Raceways and Boxes for Electrical Systems

C.8.1 Materials

1. Metal Conduits and Fittings:
 - a. GRC.
 - b. EMT.
 - c. FMC: Zinc-coated steel.
 - d. LFMC.
 - e. Fittings:
 - i EMT: Steel, compression type.
 - ii Expansion fittings.
 - iii PVC coated.
 - f. Nonmetallic Conduit and Fittings:
 - i RNC.
 - ii HDPE.
 - iii Fittings: Match conduit.
2. Metal Wireways and Auxiliary Gutters: Sheet metal with flanged-and-gasketed covers.
3. Nonmetallic Wireways and Auxiliary Gutters: Fiberglass polyester.
4. Surface Metal Raceways: Metal, galvanized steel, with snap-on covers.
5. Surface Nonmetallic Raceways: Two- or three-piece, rigid PVC.

6. Boxes, Enclosures, and Cabinets:
 - a. Metal Outlet and Device Boxes: Ferrous alloy.
 - b. Nonmetallic outlet and device boxes.
 - c. Metal Floor Boxes: Cast metal, fully adjustable.
 - d. Nonmetallic Floor Boxes: Non-adjustable, rectangular.
 - e. Small sheet metal pull and junction boxes.
 - f. Cast-metal access, pull, and junction boxes.
 - g. Box extensions.
 - h. Gangable boxes are allowed.
 - i. Hinged-Cover Enclosures: Metal.
 - j. Cabinets: Galvanized steel.
7. Handholes and Boxes for Exterior Underground Wiring: Polymer concrete with polymer-concrete, Fiberglass with polymer-concrete, or Fiberglass with reinforced concrete frame and cover, prototype tested for compliance with SCTE 77.
 - a. Configuration: Open bottom.
 - b. Weatherproof cover.
 - c. Cover Legend: "ELECTRIC."

C.9 Raceway Application

C.9.1 Outdoors:

1. Exposed: GRC.
2. Concealed, Aboveground: EMT.
3. Underground: RNC, Type EPC-40-PVC, Type EPC-80-PVC, and concrete encased.
4. Connection to Vibrating Equipment: LFMC.
5. Boxes and Enclosures, Aboveground: Type 4.

C.9.2 Indoors:

1. Exposed, Not Subject to Physical Damage: EMT.
2. Exposed and Subject to Severe Damage: GRC.
3. Concealed: EMT or MC.
4. Connection to Vibrating Equipment: FMC, except LFMC in damp or wet locations.
5. Damp or Wet Locations: GRC.
6. Boxes and Enclosures: Type 1, except Type 4 stainless steel in damp or wet locations.

C.9.3 Minimum Raceway Size: 3/4-inch trade size.

C.9.4 Raceway Fittings: Compatible with raceways and suitable for use and location.

1. Rigid and Intermediate Steel Conduit: Threaded rigid steel conduit fittings.
2. PVC Externally Coated, Rigid Steel Conduits: Fittings listed for use with this type of conduit.
3. EMT: Compression, fittings.
4. Flexible Conduit: Fittings listed for use with flexible conduit.

C.9.5 Wall/Floor penetrations

1. Penetrations through fire rated walls or floors shall be sealed with fire caulk to match wall/floor fire rating.

C.9.6 Conduit Color

1. Low voltage conduits shall be blue, security conduits shall be yellow, and fire alarm conduits shall be red.

C.10 Underground Ducts and Raceways for Electrical Systems

C.10.1 General

1. Summary

a. Section Includes:

- i Direct-buried conduit, ducts, and duct accessories.
- ii Concrete-encased conduit, ducts, and duct accessories.
- iii Handholes and boxes.
- iv Manholes.

2. Action Submittals

- ##### a. Product Data: For ducts and conduits, duct-bank materials, manholes, handholes, and boxes, and their accessories.

b. Shop Drawings:

i Precast or Factory-Fabricated Underground Utility Structures:

- 1) Include plans, elevations, sections, details, attachments to other work, and accessories.
- 2) Include duct entry provisions, including locations and duct sizes.
- 3) Include reinforcement and joint details, frame and cover design, and manhole frame support rings.

ii Factory-Fabricated Handholes and Boxes Other Than Precast Concrete:

- 1) Include dimensioned plans, sections, elevations, accessory locations, and fabrication and installation details.
- 2) Include duct entry provisions, including locations and duct sizes.

3. Informational Submittals

- a. Duct-Bank Coordination Drawings: Show duct profiles, locations of expansion fittings, and coordination with other utilities and underground structures on Drawings signed and sealed by a qualified professional engineer.
- b. Product Certificates: For concrete and steel used in precast concrete handholes, as required by ASTM C 858.
- c. Qualification Data: For professional engineer and testing agency responsible for testing nonconcrete handholes and boxes.
- d. Source quality-control reports.
- e. Field quality-control reports.

4. Quality Assurance

- a. Testing Agency Qualifications: Qualified according to ASTM E 329 for testing indicated.

5. Field Conditions

- a. Interruption of Existing Electrical Service: Do not interrupt electrical service to facilities occupied by Owner or others unless permitted by Owner, and then only after arranging to provide temporary electrical service.
- b. Ground Water: Assume ground-water level is 36 inches below ground surface unless a higher water table is noted on Drawings.

C.10.2 Products

1. General Requirements For Ducts And Raceways
 - a. Comply with ANSI C2.
2. Conduit
 - a. Rigid Steel Conduit: Galvanized. Comply with ANSI C80.1.
 - b. RNC: NEMA TC 2, Type EPC-40-PVC and Type EPC-80-PVC, UL 651, with matching fittings by same manufacturer as the conduit, complying with NEMA TC 3 and UL 514B.
3. Nonmetallic Ducts And Duct Accessories
 - a. Underground Plastic Utilities Duct: NEMA TC 2, UL 651, ASTM F 512, Type EPC-80 and Type EPC-40, with matching fittings complying with NEMA TC 3 by same manufacturer as the duct.
 - b. Solvents and Adhesives: As recommended by conduit manufacturer.
 - c. Duct Accessories:
 - i Duct Separators: Factory-fabricated rigid PVC interlocking spacers.
 - ii Warning Tape: Underground-line warning tape specified in Section "Identification for Electrical Systems."
 - iii Concrete Warning Planks: Nominal 12 by 24 by 3 inches in size, manufactured from 6000-psi red concrete and labeled "ELECTRIC."
4. Precast Concrete Handholes And Boxes
 - a. Comply with ASTM C 858 for design and manufacturing processes.
 - b. Description: Factory-fabricated, reinforced-concrete, monolithically poured walls and bottom unless open-bottom enclosures are indicated. Frame and cover shall form top of enclosure and shall have load rating consistent with that of handhole or box.
 - c. Frame and Cover: Weatherproof cast-iron frame, with cast-iron cover with recessed cover hook eyes and tamper-resistant, captive, cover-securing bolts.
 - d. Cover Finish: Nonskid finish shall have a minimum coefficient of friction of 0.50.
 - e. Cover Legend: Molded lettering, "ELECTRIC."
 - f. Configuration: Units shall be designed for flush burial and have open bottom unless otherwise indicated.
 - g. Extensions and Slabs: Designed to mate with bottom of enclosure. Same material as enclosure.
 - h. Extension shall provide increased depth of 12 inches.
 - i. Slab: Same dimensions as bottom of enclosure and arranged to provide closure.
 - j. Joint Sealant: Asphaltic-butyl material with adhesion, cohesion, flexibility, and durability properties necessary to withstand maximum hydrostatic pressures at the installation location with the ground-water level at grade.
 - k. Windows: Precast, reinforced openings in walls, arranged to match dimensions and elevations of approaching ducts and duct banks, plus an additional 12 inches vertically and horizontally to accommodate alignment variations.
 - l. Duct Entrances in Handhole Walls: Cast end-bell or duct-terminating fitting in wall for each entering duct.

- m. Handholes 24 inches wide by 36 inches long and larger shall have inserts for cable racks and pulling-in irons installed before concrete is poured.
- n. Joint Sealant: Asphaltic-butyl material with adhesion, cohesion, flexibility, and durability properties necessary to withstand maximum hydrostatic pressures at the installation location with the ground-water level at grade.

C.10.3 Execution

1. Underground Duct Application

- a. Ducts for Electrical Cables More than 600 V: RNC, NEMA Type EPC-80-PVC (confirm with Utility, prior to installation), in concrete-encased duct bank unless otherwise indicated.
- b. Ducts for Electrical Feeders 600 V and Less: RNC, NEMA Type EPC-40-PVC, in direct-buried duct bank unless otherwise indicated.
- c. Ducts for Electrical Branch Circuits: RNC, NEMA Type EPC-40-PVC, in direct-buried duct bank unless otherwise indicated.
- d. Underground Ducts Crossing Paved Paths, Driveways, Roadways, and Railroads: RNC, NEMA Type EPC-80-PVC, encased in reinforced concrete.

2. Underground Enclosure Application

- a. Handholes and Boxes for 600 V and Less:
 - i Units in Roadways and Other Deliberate Traffic Paths: Precast concrete, AASHTO HB 17, H-10 structural load rating.
 - ii Units in Driveway, Parking Lot, and Off-Roadway Locations, Subject to Occasional, Nondeliberate Loading by Heavy Vehicles: Precast concrete, AASHTO HB 17, H-20 structural load rating.
 - iii Units in Sidewalk and Similar Applications with a Safety Factor for Nondeliberate Loading by Vehicles: Polymer concrete units, SCTE 77, Tier 8 structural load rating.
 - iv Units Subject to Light-Duty Pedestrian Traffic Only: Fiberglass-reinforced polyester resin, structurally tested according to SCTE 77 with 3000-lbf vertical loading.
 - v Cover design load shall not exceed the design load of the handhole or box.

3. Earthwork

- a. Excavation and Backfill: Comply with Section "Earth Moving," but do not use heavy-duty, hydraulic-operated, compaction equipment.
- b. Restore areas disturbed by trenching, storing of dirt, cable laying, and other work. Restore vegetation and include necessary topsoiling, fertilizing, liming, seeding, sodding, sprigging, and mulching. Comply with Section "Turf and Grasses" and Section "Plants."
- c. Cut and patch existing pavement in the path of underground ducts and utility structures according to the "Cutting and Patching" Article in Section "Execution."

4. Duct Installation

- a. Install ducts according to NEMA TCB 2.
- b. Slope: Pitch ducts a minimum slope of 1:300 down toward manholes and handholes and away from buildings and equipment. Slope ducts from a high point in runs between two manholes, to drain in both directions.
- c. Curves and Bends: Use 5-degree angle couplings for small changes in direction. Use manufactured long sweep bends with a minimum radius of 48 inches, both horizontally and vertically, at other locations unless otherwise indicated.
- d. Joints: Use solvent-cemented joints in ducts and fittings and make watertight according to manufacturer's written instructions. Stagger couplings so those of adjacent ducts do not lie in same plane.

- e. Duct Entrances to Manholes and Concrete and Polymer Concrete Handholes: Use end bells, spaced approximately 10 inches o.c. for 5-inch ducts, and vary proportionately for other duct sizes.
 - i Begin change from regular spacing to end-bell spacing 10 feet from the end bell without reducing duct line slope and without forming a trap in the line.
 - ii Direct-Buried Duct Banks: Install an expansion and deflection fitting in each conduit in the area of disturbed earth adjacent to manhole or handhole. Install an expansion fitting near the center of all straight line direct-buried duct banks with calculated expansion of more than 3/4 inch.
 - iii Grout end bells into structure walls from both sides to provide watertight entrances.
- f. Building Wall Penetrations: Make a transition from underground duct to rigid steel conduit at least 10 feet outside the building wall, without reducing duct line slope away from the building, and without forming a trap in the line. Use fittings manufactured for duct-to-conduit transition. Install conduit penetrations of building walls as specified in Section "Sleeves and Sleeve Seals for Electrical Raceways and Cabling."
- g. Sealing: Provide temporary closure at terminations of ducts that have cables pulled. Seal spare ducts at terminations. Use sealing compound and plugs to withstand at least 15-psig hydrostatic pressure.
- h. Pulling Cord: Install 100-lbf test nylon cord in empty ducts.
- i. Concrete-Encased Ducts: Support ducts on duct separators.
 - i Excavate trench bottom to provide firm and uniform support for duct bank. Prepare trench bottoms as specified in Section "Earth Moving" for pipes less than 6 inches in nominal diameter.
 - ii Depth: Install top of duct bank at least 24 inches below finished grade in areas not subject to deliberate traffic, and at least 30 inches below finished grade in deliberate traffic paths for vehicles unless otherwise indicated.
 - iii Support ducts on duct separators coordinated with duct size, duct spacing, and outdoor temperature.
 - iv Separator Installation: Space separators close enough to prevent sagging and deforming of ducts, with not less than four spacers per 20 feet of duct. Secure separators to earth and to ducts to prevent floating during concreting. Stagger separators approximately 6 inches between tiers. Tie entire assembly together using fabric straps; do not use tie wires or reinforcing steel that may form conductive or magnetic loops around ducts or duct groups.
 - v Minimum Space between Ducts: 3 inches between ducts and exterior envelope wall, 2 inches between ducts for like services, and 4 inches between power and signal ducts.
 - vi Elbows: Use manufactured rigid steel conduit elbows for stub-ups at poles and equipment, at building entrances through floor, and at changes of direction in duct run.
 - 1) Couple steel conduits to ducts with adapters designed for this purpose and encase coupling with 3 inches of concrete.
 - 2) Stub-Ups to Equipment: For equipment mounted on outdoor concrete bases, extend steel conduit horizontally a minimum of 60 inches from edge of base. Install insulated grounding bushings on terminations at equipment.
 - vii Reinforcement: Reinforce concrete-encased duct banks where they cross disturbed earth and where indicated. Arrange reinforcing rods and ties without forming conductive or magnetic loops around ducts or duct groups.
 - viii Forms: Use walls of trench to form side walls of duct bank where soil is self-supporting and concrete envelope can be poured without soil inclusions; otherwise, use forms.
 - ix Concrete Cover: Install a minimum of 3 inches of concrete cover at top and bottom, and a minimum of 2 inches on each side of duct bank.

- x Pouring Concrete: Comply with requirements in "Concrete Placement" Article in Section "Cast-in-Place Concrete." Place concrete carefully during pours to prevent voids under and between conduits and at exterior surface of envelope. Do not allow a heavy mass of concrete to fall directly onto ducts. Allow concrete to flow to center of bank and rise up in middle, uniformly filling all open spaces. Do not use power-driven agitating equipment unless specifically designed for duct-bank application.
5. Installation of Concrete Manholes, Handholes, And Boxes
- a. Precast Concrete Handhole and Manhole Installation:
 - i Comply with ASTM C 891 unless otherwise indicated.
 - ii Install units level and plumb and with orientation and depth coordinated with connecting ducts, to minimize bends and deflections required for proper entrances.
 - iii Unless otherwise indicated, support units on a level bed of crushed stone or gravel, graded from 1-inch sieve to No. 4 sieve and compacted to same density as adjacent undisturbed earth.
 - b. Handhole and manholes covers shall have labels (power, communications, etc).
 - c. Drainage: Install drains in bottom of manholes where indicated. Coordinate with drainage provisions indicated.
 - d. Manhole Access: Circular opening in manhole roof; sized to match cover size.
 - i Manholes with Fixed Ladders: Offset access opening from manhole centerlines to align with ladder.
 - ii Install chimney, constructed of precast concrete collars and rings, to support cast-iron frame to connect cover with manhole roof opening. Provide moisture-tight masonry joints and waterproof grouting for frame to chimney.
 - e. Waterproofing: Apply waterproofing to exterior surfaces of manholes and handholes after concrete has cured at least three days. After ducts have been connected and grouted, and before backfilling, waterproof joints and connections, and touch up abrasions and scars. Waterproof exterior of manhole chimneys after mortar has cured at least three days.
 - f. Dampproofing: Apply dampproofing to exterior surfaces of manholes and handholes after concrete has cured at least three days. Dampproofing materials and installation are specified in Section "Bituminous Dampproofing." After ducts are connected and grouted, and before backfilling, dampproof joints and connections, and touch up abrasions and scars. Dampproof exterior of manhole chimneys after mortar has cured at least three days.
 - g. Hardware: Install removable hardware, including pulling eyes, cable stanchions, and cable arms, and insulators, as required for installation and support of cables and conductors and as indicated.
 - h. Fixed Manhole Ladders: Arrange to provide for safe entry with maximum clearance from cables and other items in manholes.
 - i. Field-Installed Bolting Anchors in Manholes and Concrete Handholes: Do not drill deeper than 3-7/8 inches for manholes and 2 inches for handholes, for anchor bolts installed in the field. Use a minimum of two anchors for each cable stanchion.
6. Grounding
- a. Ground underground ducts and utility structures according to "Grounding and Bonding for Electrical Systems."
7. Field Quality Control
- a. Perform the following tests and inspections and prepare test reports:
 - i Demonstrate capability and compliance with requirements on completion of installation of underground ducts and utility structures.

- ii Pull solid aluminum or wood test mandrel through duct to prove joint integrity and adequate bend radii, and test for out-of-round duct. Provide a minimum 6-inch long mandrel equal to 80 percent fill of duct. If obstructions are indicated, remove obstructions and retest.
 - iii Test handhole grounding to ensure electrical continuity of grounding and bonding connections. Measure and report ground resistance as specified in "Grounding and Bonding for Electrical Systems."
- b. Correct deficiencies and retest as specified above to demonstrate compliance.
8. Cleaning
- a. Pull leather-washer-type duct cleaner, with graduated washer sizes, through full length of ducts. Follow with rubber duct swab for final cleaning and to assist in spreading lubricant throughout ducts.
 - b. Clean internal surfaces of manholes, including sump. Remove foreign material.

C.11 Sleeves and Sleeve Seals for Electrical Raceways and Cabling

C.11.1 Round Sleeves

1. Wall Sleeves, Steel:
 - a. Description: ASTM A53/A53M, Type E, Grade B, Schedule 40, zinc coated, plain ends and integral waterstop.
2. Wall Sleeves, Cast Iron:
 - a. Description: Cast or fabricated "wall pipe," equivalent to ductile-iron pressure pipe, with plain ends and integral waterstop.
3. Pipe Sleeves, PVC:
 - a. Description: ASTM D1785, Schedule 40.
4. Molded Sleeves, PVC:
 - a. Description: With nailing flange for attaching to wooden forms.
5. Molded Sleeves, PE or PP:
 - a. Description: Removable, tapered-cup shaped, and smooth outer surface with nailing flange for attaching to wooden forms.
6. Sheet Metal Sleeves, Galvanized Steel, Round:

C.11.2 Rectangular Sleeves

1. Sheet Metal Sleeves, Galvanized Steel, Rectangular:

C.11.3 Sleeve Seal Systems

1. Description: Modular sealing device, designed for field assembly, to fill annular space between sleeve and raceway or cable or between raceway and cable.
2. Sealing Elements: EPDM rubber interlocking links shaped to fit surface of pipe. Include type and number required for pipe material and size of pipe.
3. Pressure Plates: Carbon steel.
4. Connecting Bolts and Nuts: Carbon steel, with corrosion-resistant coating, of length required to secure pressure plates to sealing elements.

C.11.4 Grout

1. Description: Nonshrink; recommended for interior and exterior sealing openings in non-fire-rated walls or floors.

C.11.5 Pourable Sealants

1. Description: Single-component, neutral-curing elastomeric sealants of grade indicated below.
2. Sustainability Criteria:
 - a. Sealant shall have a VOC content per local requirements or less.
 - b. Sealant shall comply with the testing and product requirements of the California Department of Public Health's "Standard Method for the Testing and Evaluation of Volatile Organic Chemical Emissions from Indoor Sources Using Environmental Chambers."
3. Action Submittals:
 - a. Product Data: For sealants, indicating VOC content.
 - b. Laboratory Test Reports: For sealants, indicating compliance with requirements for low-emitting materials.

C.11.6 Foam Sealants

1. Description: Multicomponent, liquid elastomers that, when mixed, expand and cure in place to produce a flexible, nonshrinking foam.
2. Sustainability Criteria:
 - a. Sealant shall have a VOC content per local requirements or less.
 - b. Sealant shall comply with the testing and product requirements of the California Department of Public Health's "Standard Method for the Testing and Evaluation of Volatile Organic Chemical Emissions from Indoor Sources Using Environmental Chambers."
3. Action Submittals:
 - a. Product Data: For sealants, indicating VOC content.
 - b. Laboratory Test Reports: For sealants, indicating compliance with requirements for low-emitting materials.

C.11.7 Installation Of Sleeves For Non-Fire-Rated Electrical Penetrations

1. Sleeves for Conduits Penetrating Above-Grade, Non-Fire-Rated, Concrete and Masonry-Unit Floors and Walls:
 - a. Size pipe sleeves to provide 1/4-inch annular clear space between sleeve and raceway or cable, unless sleeve seal system is to be installed.
 - b. Extend sleeves installed in floors 2 inches above finished floor level.
2. Aboveground, Exterior-Wall Penetrations: Seal penetrations using steel pipe sleeves and mechanical sleeve seal systems.
3. Underground, Exterior-Wall and Floor Penetrations: Install steel pipe sleeves with integral waterstops.

C.12 Identification for Electrical Systems

C.12.1 Products

1. Equipment Identification Labels:
 - a. Normal Power: Black letters on a white field.
 - b. Emergency Power: White letters on a red background.
2. Labels:
 - a. Vinyl wraparound labels.
 - b. Snap-around labels.
 - c. Self-Adhesive Wraparound Labels: Preprinted flexible labels with pressure-sensitive adhesive.

- d. Self-Adhesive Labels: Polyester, multicolor, weather- and UV-resistant, pressure-sensitive adhesive labels.
 - e. Labels shall include equipment name, voltage, and source of power.
3. Bands and Tubes:
 - a. Snap-around color-coding bands.
 - b. Heat-shrink preprinted tubes.
 4. Tapes and Stencils:
 - a. Marker tapes.
 - b. Self-adhesive vinyl tape.
 - c. Tape and stencil.
 - d. Floor marking tape.
 - e. Underground-line warning tape.
 5. Tags:
 - a. Brass or aluminum metal tags.
 - b. Polyethylene preprinted tags.
 - c. Polyester write-on tags.
 6. Signs:
 - a. Preprinted aluminum baked-enamel signs.
 - b. Metal-backed butyrate signs.
 - c. Laminated acrylic or melamine plastic signs.
 7. Cable Ties:
 - a. General-purpose cable ties.
 - b. UV-stabilized cable ties.
 - c. Plenum-rated cable ties.

C.12.2 Short-Circuit Studies

1. Summary
 - a. Computer-based, fault-current study.
 - b. Software Capability
 - c. Comply with IEEE 399 and IEEE 551.
2. Execution
 - a. Fault-Current Study: Electrical distribution system from normal and alternate power sources.
 - b. Begin short-circuit current analysis at the service, extending down to the system overcurrent protective devices as follows:
 - i. To normal system low-voltage load buses where fault current is 10 kA or less.
 - c. Calculate short-circuit momentary and interrupting duties for a three-phase bolted fault and a single line-to-ground fault at each equipment indicated on the one-line diagram.

C.13 Overcurrent Protective Device Coordination Study

C.13.1 General

C.13.1.1 Summary

1. Section includes computer-based, overcurrent protective device coordination studies to determine overcurrent protective devices and to determine overcurrent protective device settings for selective tripping.

C.13.1.2 Action Submittals

1. Product Data: For computer software program to be used for studies.
2. Other Action Submittals: Submit the following after the approval of system protective devices submittals. Submittals may be in digital form.
 - a. Coordination-study input data, including completed computer program input data sheets.
 - b. Study and equipment evaluation reports.
 - c. Overcurrent protective device coordination study report; signed, dated, and sealed by a qualified professional engineer.
 - i. Submit study report for action prior to receiving final approval of the distribution equipment submittals. If formal completion of studies will cause delay in equipment manufacturing, obtain approval from Architect for preliminary submittal of sufficient study data to ensure that the selection of devices and associated characteristics is satisfactory.

C.13.1.3 Informational Submittals

1. Qualification Data: For Coordination Study Specialist.
2. Product Certificates: For overcurrent protective device coordination study software, certifying compliance with IEEE 399.

C.13.1.4 Closeout Submittals

1. Operation and Maintenance Data: For the overcurrent protective devices to include in emergency, operation, and maintenance manuals.
 - a. In addition to items specified in Section "Operation and Maintenance Data," include the following:
 - i. The following parts from the Protective Device Coordination Study Report:
 - 1) One-line diagram.
 - 2) Protective device coordination study.
 - 3) Time-current coordination curves.
 - 4) Power system data.

C.13.1.5 Quality Assurance

1. Studies shall use computer programs that are distributed nationally and are in wide use. Software algorithms shall comply with requirements of standards and guides specified in this Section. Manual calculations are unacceptable.
2. Coordination Study Software Developer Qualifications: An entity that owns and markets computer software used for studies, having performed successful studies of similar magnitude on electrical distribution systems using similar devices.
3. The computer program shall be developed under the charge of a licensed professional engineer who holds IEEE Computer Society's Certified Software Development Professional certification.

4. Coordination Study Specialist Qualifications: Professional engineer in charge of performing the study and documenting recommendations, licensed in the state where Project is located. All elements of the study shall be performed under the direct supervision and control of this professional engineer.
5. Field Adjusting Agency Qualifications: An independent agency, with the experience and capability to adjust overcurrent devices and to conduct the testing indicated, that is a member company of the International Electrical Testing Association or is a nationally recognized testing laboratory (NRTL) as defined by OSHA in 29 CFR 1910.7, and that is acceptable to authorities having jurisdiction.

C.13.1.6 Products

1. Computer Software Developers
2. Comply with IEEE 242 and IEEE 399.
3. Analytical features of device coordination study computer software program shall have the capability to calculate mandatory features as listed in IEEE 399.
4. Computer software program shall be capable of plotting and diagramming time-current-characteristic curves as part of its output. Computer software program shall report device settings and ratings of all overcurrent protective devices and shall demonstrate selective coordination by computer-generated, time-current coordination plots.

C.13.1.7 Protective Device Coordination Study Report Contents

1. Executive summary.
2. Study descriptions, purpose, basis and scope. Include case descriptions, definition of terms and guide for interpretation of the computer printout.
3. One-line diagram, showing the following:
 - a. Protective device designations and ampere ratings.
 - b. Cable size and lengths.
 - c. Transformer kilovolt ampere (kVA) and voltage ratings.
 - d. Motor and generator designations and kVA ratings.
 - e. Switchgear, switchboard, motor-control center, and panelboard designations.
4. Study Input Data: As described in "Power System Data" Article.
5. Short-Circuit Study Output: As specified in "Short Circuit Study Output" Paragraph in "Short-Circuit Study Report Contents" Article in Section "Overcurrent Protective Device Short-Circuit Study."
6. Protective Device Coordination Study:
 - a. Report recommended settings of protective devices, ready to be applied in the field. Use manufacturer's data sheets for recording the recommended setting of overcurrent protective devices when available.
 - b. Phase and Ground Relays:
 - i Device tag.
 - ii Relay current transformer ratio and tap, time dial, and instantaneous pickup value.
 - iii Recommendations on improved relaying systems, if applicable.
 - c. Circuit Breakers:
 - i Adjustable pickups and time delays (long time, short time, ground).
 - ii Adjustable time-current characteristic.

- iii Adjustable instantaneous pickup.
 - iv Recommendations on improved trip systems, if applicable.
 - d. Fuses: Show current rating, voltage, and class.
- 7. Time-Current Coordination Curves: Determine settings of overcurrent protective devices to achieve selective coordination. Graphically illustrate that adequate time separation exists between devices installed in series, including power utility company's upstream devices. Prepare separate sets of curves for the switching schemes and for emergency periods where the power source is local generation. Show the following information:
 - a. Device tag and title, one-line diagram with legend identifying the portion of the system covered.
 - b. Terminate device characteristic curves at a point reflecting maximum symmetrical or asymmetrical fault current to which the device is exposed.
 - c. Identify the device associated with each curve by manufacturer type, function, and, if applicable, tap, time delay, and instantaneous settings recommended.
 - d. Plot the following listed characteristic curves, as applicable:
 - i Power utility's overcurrent protective device.
 - ii Low-voltage fuses including manufacturer's minimum melt, total clearing, tolerance, and damage bands.
 - iii Low-voltage equipment circuit-breaker trip devices, including manufacturer's tolerance bands.
 - iv Transformer full-load current, magnetizing inrush current.
 - v Ground-fault protective devices.
 - vi The largest feeder circuit breaker in each motor-control center and panelboard.
 - e. Provide adequate time margins between device characteristics such that selective operation is achieved.
 - f. Comments and recommendations for system improvements.

C.13.2 Execution

C.13.2.1 Examination

1. Examine Project overcurrent protective device submittals for compliance with electrical distribution system coordination requirements and other conditions affecting performance. Devices to be coordinated are indicated on Drawings.
 - a. Proceed with coordination study only after relevant equipment submittals have been assembled. Overcurrent protective devices that have not been submitted and approved prior to coordination study may not be used in study.

C.13.2.2 Protective Device Coordination Study

1. Comply with IEEE 242 for calculating short-circuit currents and determining coordination time intervals.
2. Comply with IEEE 399 for general study procedures.
3. The study shall be based on the device characteristics supplied by device manufacturer.
4. The extent of the electrical power system to be studied is indicated on Drawings.
5. Begin analysis at the service, extending down to the system overcurrent protective devices as follows:
 - a. To normal system low-voltage load buses where fault current is 10 kA or less.

6. Study electrical distribution system from normal and alternate power sources throughout electrical distribution system for Project. Study all cases of system-switching configurations and alternate operations that could result in maximum fault conditions.
7. The calculations shall include the ac fault-current decay from induction motors. The calculations shall also account for the fault-current dc decrement, to address the asymmetrical requirements of the interrupting equipment.
 - a. For grounded systems, provide a bolted line-to-ground fault-current study for areas as defined for the three-phase bolted fault short-circuit study.
8. Calculate short-circuit momentary and interrupting duties for a three-phase bolted fault and single line-to-ground fault at each of the following:
 - a. Electric utility's supply termination point.
 - b. Switchgear.
 - c. Low-voltage switchgear.
 - d. Generators and automatic transfer switches.
 - e. Branch circuit panelboards.
9. Protective Device Evaluation:
 - a. Evaluate equipment and protective devices and compare to short-circuit ratings.
 - b. Adequacy of switchgear, motor-control centers, and panelboard bus bars to withstand short-circuit stresses.

C.13.2.3 Power System Data

1. Obtain all data necessary for the conduct of the overcurrent protective device study.
 - a. Verify completeness of data supplied in the one-line diagram on Drawings. Call discrepancies to the attention of Architect.
 - b. Use characteristics submitted under the provisions of action submittals and information submittals for this Project.
2. Gather and tabulate the following input data to support coordination study. The list below is a guide.
 - a. Product Data for overcurrent protective devices specified in other Sections and involved in overcurrent protective device coordination studies. Use equipment designation tags that are consistent with electrical distribution system diagrams, overcurrent protective device submittals, input and output data, and recommended device settings.
 - b. Electrical power utility impedance at the service.
 - c. Power sources and ties.
 - d. Short-circuit current at each system bus, three phase and line-to-ground.
 - e. Full-load current of all loads.
 - f. Voltage level at each bus.
 - g. For transformers, include kVA, primary and secondary voltages, connection type, impedance, X/R ratio, taps measured in percent, and phase shift.
 - h. For circuit breakers and fuses, provide manufacturer and model designation. List type of breaker, type of trip and available range of settings, SCCR, current rating, and breaker settings.
 - i. Maximum demands from service meters.
 - j. Busway manufacturer and model designation, current rating, impedance, lengths, and conductor material.
 - k. Motor horsepower and NEMA MG 1 code letter designation.

- l. Low-voltage cable sizes, lengths, number, conductor material, and conduit material (magnetic or nonmagnetic).
- m. Data sheets to supplement electrical distribution system diagram, cross-referenced with tag numbers on diagram, showing the following:
 - i. Special load considerations, including starting inrush currents and frequent starting and stopping.
 - ii. Ratings, types, and settings of utility company's overcurrent protective devices.
 - iii. Special overcurrent protective device settings or types stipulated by utility company.
 - iv. Time-current-characteristic curves of devices indicated to be coordinated.
 - v. Manufacturer, frame size, interrupting rating in amperes rms symmetrical, ampere or current sensor rating, long-time adjustment range, short-time adjustment range, and instantaneous adjustment range for circuit breakers.
 - vi. Manufacturer and type, ampere-tap adjustment range, time-delay adjustment range, instantaneous attachment adjustment range, and current transformer ratio for overcurrent relays.
 - vii. Panelboards, switchboards, motor-control center ampacity, and SCCR in amperes rms symmetrical.

C.13.2.4 Field Adjusting

1. Adjust relay and protective device settings according to the recommended settings provided by the coordination study. Field adjustments shall be completed by the engineering service division of the equipment manufacturer under the Startup and Acceptance Testing contract portion.
2. Make minor modifications to equipment as required to accomplish compliance with short-circuit and protective device coordination studies.
3. Testing and adjusting shall be by a full-time employee of the Field Adjusting Agency, who holds NETA ETT Level III certification or NICET Electrical Power Testing Level III certification.
 - a. Perform each visual and mechanical inspection and electrical test stated in NETA Acceptance Testing Specification. Certify compliance with test parameters. Perform NETA tests and inspections for all adjustable overcurrent protective devices.

C.13.2.5 Demonstration

1. Engage the Coordination Study Specialist to train Owner's maintenance personnel in the following:
 - a. Acquaint personnel in the fundamentals of operating the power system in normal and emergency modes.
 - b. Hand-out and explain the objectives of the coordination study, study descriptions, purpose, basis, and scope. Include case descriptions, definition of terms, and guide for interpreting the time-current coordination curves.
 - c. Adjust, operate, and maintain overcurrent protective device settings.

C.14 Arc-Flash Hazard Analysis

C.14.1 Summary

1. Computer-based, arc-flash study to determine the arc-flash hazard distance and the incident energy to which personnel could be exposed during work on or near electrical equipment.

C.14.2 Software Capability

1. Comply with IEEE 1584 and NFPA 70E.
2. Produce 3.5-by-5-inch labels for each work location included in the analysis.

C.14.3 Execution

1. Calculate the arc-flash protection boundary and incident energy at locations in the electrical distribution system where personnel could perform work on energized parts.
2. Include medium- and low-voltage equipment locations.
3. Calculate the limited, restricted, and prohibited approach boundaries for each location.
4. Base arc-flash calculations on actual overcurrent protective device clearing time. Cap maximum clearing time at two seconds based on IEEE 1584, Section B.1.2.

C.15 Commissioning of Electrical Systems

C.15.1 Summary

1. Electrical equipment connected to Normal power systems.
2. Electrical equipment connected to Essential power systems that provide an alternative source of power in the absence of power from the Normal power system.
3. Controls and instrumentation.
4. Systems testing and verification, including Normal and Essential power systems, and transitions from Normal to Essential power systems and back.

C.15.2 Quality Assurance

1. Electrical testing technician.
2. Testing equipment and instrumentation.

C.15.3 Construction Checklists

1. Checklists for electrical systems, subsystems, equipment, and components.

C.15.4 Cx Tests For Electrical Systems

1. Verification of Normal and Essential power system operation.
2. Verification of control and instrumentation.
3. Verification of generator.
4. Verification of transfer switch.
5. Verification of lighting controls.
6. Verification of emergency lighting.

C.16 Electrical Power Monitoring and Control

C.16.1 System Description

1. Microprocessor-based monitoring and control of electrical power distribution system(s) that includes the following:
 - a. Electrical meters that monitor, control, and connect to the data transmission network (Internet capable).

C.16.2 System Description

1. Quality Standards for Meters: Comply with NFPA 70. Listed and labeled as complying with UL 61010-1.

C.16.3 Performance Requirements

1. Surge protection.
2. Addressable devices.
3. DDC interface.
4. Backup power.

C.16.4 Multifunction Energy Meters

1. Separately mounted, modular, permanently installed, solid-state, digital I/O instrument for power and energy metering and monitoring; complying with UL 61010-1.
2. Overvoltage: Comply with UL 61010-1.
3. Accuracy: Comply with ANSI C12.20, Class 0.5.
4. Data link.
5. Backlit LCD capable of displaying three user selected values at one time.
6. Sampling Rate: No less than 64 samples per cycle.
7. Meters:
 - a. Instantaneous.
 - b. Energy.
 - c. Demand.
 - d. Power quality.

C.16.5 Power Meters

1. Separately mounted, modular, permanently installed, solid-state, digital I/O instrument for power monitoring and control; complying with UL 61010-1.
2. Enclosure: IP51 for the front and IP30 for the body.
3. Overvoltage: Comply with UL 61010-1.
4. Accuracy: Comply with ANSI C12.20, Class 0.5.
5. Data link.
6. Backlit LCD capable of displaying four user-selected values at one time.
7. Sampling Rate: No less than 32 samples per cycle.
8. Meters:
 - a. Instantaneous.
 - b. Harmonic distortion.
 - c. Energy.
 - d. Demand.
 - e. Minimum and maximum values.
 - f. Power demand, user selectable.
 - g. Data recording.
 - h. Alarms.
 - i. Output signals.

C.16.6 Circuit Meters And Monitors

1. Description: Separately mounted, modular, permanently installed, solid-state, digital I/O instrument for power monitoring and control; complying with UL 61010-1. Capable of metering 4-wire Y, 3-wire Y, 3-wire delta, and single-phase power systems.
2. Overvoltage: Comply with UL 61010-1.
3. Accuracy: Comply with ANSI C12.20, Class 0.5.
4. Data link.
5. Backlit LCD capable of displaying four user-selected values at one time.

6. Sampling Rate: No less than 128 samples per cycle.
7. Meters:
 - a. Instantaneous.
 - b. Harmonic distortion.
 - c. Energy.
 - d. Demand.
 - e. Minimum and maximum values.
8. Power demand, user selectable.
9. Trend curves.
10. Waveform capture.
11. Disturbance detection and alarm.
12. Harmonics information.
13. Alarms.
14. EN 50160 evaluation.
15. I/O module.
16. Data Recording:
 - a. Data logs.
 - b. Minimum/maximum logs.
 - c. Alarm logs.
 - d. Waveform logs.

C.16.7 Circuit Meters And Explorers

1. Description: Separately mounted, modular, permanently installed, solid-state, digital I/O instrument for power monitoring, control, and power quality explorer; complying with UL 61010-1.
2. Accuracy to the following plus/minus values:
 - a. Voltage and Current Meter: 0.04 percent of reading plus 0.025 percent of full scale.
 - b. Power and Energy Meter: 0.075 percent of reading plus 0.025 percent of full scale.
 - c. Energy Meter: Comply with ANSI C12.20, Class 0.20.
 - d. Frequency Meter: 0.01 Hz in the range of 45 to 67 Hz and accurate to 0.1 Hz in the range of 350 to 450 Hz.
 - e. Power Factor: 0.002 from 0.5 leading to 0.5 lagging.
3. Data links.
4. Backlit LCD capable of displaying four user-selected values at one time.
5. Sampling Rate: No less than 512 samples per cycle.
6. Meters:
 - a. Instantaneous, in real time, to the 63rd harmonic.
 - b. THD.
 - c. Energy.
 - d. Demand, including voltage, current, active power, reactive power, apparently power, and distortion power factor.
 - e. Minimum and maximum values.

7. Power demand, user selectable.
8. Trend curves.
9. Power analysis values.
10. Waveform capture.
11. Transient detection.
12. Flicker detection.
13. Sag and swell detection and alarm.
14. Disturbance detection and alarm.
15. Harmonics information.
16. Alarms.
17. EN 50160 evaluation.
18. I/O module.
19. Onboard data logs.
20. Programming.

C.16.8 PC Operating System Software

1. Description: System software shall monitor, analyze, display, control, and save all the parameters and features available at the connected meter.

C.16.9 Networked PC Operating System Software

1. Description: System software shall monitor, analyze, display, control, and save parameters and features available at each of the connected meters.
 - a. Configured to run on a single PC and able to control multiple devices simultaneously.

C.16.10 Power Monitoring And Control Software

1. Data storage and data sharing.
2. Project-specific graphics, including a site plan and system schematic.

C.16.11 Network Configuration Software

1. Network management graphical interface.
2. Database maintenance.
3. Web reporter.

C.16.12 Monitoring and Control of Power Distribution Equipment

1. Power Distribution Equipment: Web-enabled, direct connected to the LAN or intranet.
2. Instrument Transformers: Comply with IEEE C57.13.
3. Ethernet connectivity.
4. Ethernet gateways.
5. Distribution equipment monitoring.

C.16.13 System Operator Interfaces

1. Desktop workstation.
2. Portable workstation.
3. Remote connection using an outside of system PC, tablet, phone, or internet-connected device.

C.16.14 Source Quality Control

1. Testing Agency: Contractor engaged.

C.16.15 Installation

1. Wiring Method: In raceways.

C.16.16 Field Quality Control

1. Testing Agency: Contractor engaged.

C.16.17 Low-Voltage Distribution Transformers

1. Summary
 - a. Section includes distribution, dry-type transformers with a nominal primary and secondary rating of 600 V and less, with capacities up to 150 kVA.
2. Products
 - a. General Transformer Requirements:
 - i Coils: Copper, continuous windings without splices except for taps.
 - ii Transformers Rated 15 kVA and Larger:
 - 1) Comply with 10 CFR 431 (DOE 2016) efficiency levels.
 - 2) Mark as compliant with DOE 2016 efficiency levels.
3. Distribution Transformers:
 - a. Core: One leg per phase.
 - b. Coils: Copper, continuous windings without splices except for taps.
 - c. Enclosure:
 - i Ventilated.
 - d. Taps for Transformers Smaller Than 3 kVA: None.
 - e. Taps for Transformers 7.5 to 24 kVA: One 5 percent tap above and one 5 percent tap below normal full capacity.
 - f. Taps for Transformers 25 kVA and Larger: Two 2.5 percent taps above and two 2.5 percent taps below normal full capacity.
 - g. Insulation Class: 220 deg C, with maximum 150 deg C rise above 40 deg C.
 - h. Features:
 - i K-factor rating.
 - ii Electrostatic shielding.
 - iii Neutral: Rated 200 percent of full load current for K-factor-rated transformers.
 - iv Wall brackets.
 - v Fungus proofing.
 - vi Low sound level.
 - i. Efficiently: 45 kVA – 97.7, 30 kVA – 97.5, 15 kVA – 97.0.
4. Source Quality Control
 - a. Transformers: Factory tested and inspected.
 - b. Factory Sound-Level Tests: Conduct prototype sound-level tests on production-line products.
5. Field Quality Control
 - a. Testing: By Contractor.

C.17 Panelboards

C.17.1 Quality Assurance

1. Manufacturer Qualifications: ISO 9001 or ISO 9002 certified.

C.17.2 Warranty

1. Panelboards: 18 months.
2. SPD: Five years.

C.17.3 Products

C.17.3.1 General Requirements for Panelboards:

1. Constructed to withstand seismic forces.
2. Enclosures: Surface mounted.
 - a. Front: Hinged cover.
 - b. Directory card.
3. Incoming Mains: Convertible between top and bottom.
4. Phase, Neutral, and Ground Buses: Copper.
 - a. Optional Buses: Equipment ground
5. Conductor Connectors:
 - a. Material: Hard-drawn copper.
 - b. Main and Neutral Lugs: Compression type.
 - c. Ground Lugs and Bus-Configured Terminators: Compression type.
 - d. Gutter Tap Lugs: Compression type.
 - e. Extra-Capacity Neutral Lugs: Rated 200 percent of phase lugs.
6. Percentage of Future Space Capacity: 10 percent.
7. Service equipment label for panelboards incorporating one or more main service disconnecting and overcurrent protective devices.
8. Panelboard Short-Circuit Current Rating: Fully rated to interrupt symmetrical short-circuit current available at terminals.
 - a. Mains: Circuit breaker or Lugs only.
 - b. Branch Overcurrent Protective Devices for Circuit-Breaker Frame Sizes 125 A and Smaller: Bolt-on circuit breakers
 - c. Branch Overcurrent Protective Devices for Circuit-Breaker Frame Sizes Larger than 125 A: Bolt-on circuit breakers.
 - d. Branch Overcurrent Protective Devices: Fused switches.
9. Lighting and Appliance Branch-Circuit Panelboards:
 - a. Mains: Circuit breaker or lugs only, per drawings.
 - b. Branch Overcurrent Protective Devices: Bolt-on circuit-breaker type.
 - c. Doors: Door in door construction with concealed hinges.
10. Electronic-Grade Panelboards:
 - a. Doors: Secured with vault-type latch.
 - b. Bolt-on, thermal-magnetic circuit-breaker main and branch overcurrent protective devices.

- c. Built-in SPDs.
 - i Peak Single-Impulse Surge Current Rating: Not less than 100 kA; the arithmetic sum of the ratings of the individual MOVs in a given mode.
 - ii Protection modes and VPR for grounded wye circuits with 480Y/277 V or 208Y/120 V (per drawings), three-phase, four-wire circuits shall not exceed the following:
 - iii Line to Neutral: 1200 V for 480Y/277 V, 700 V for 208Y/120 V.
 - iv Line to Ground: 1200 V for 480Y/277 V, 700 V for 208Y/120 V.
 - d. Protection modes and UL 1449 VPR for 240/120-V, single-phase, three-wire circuits shall not exceed the following:
 - i Line to Neutral: 700 V.
 - ii Line to Ground: 700 V.
 - iii Neutral to Ground: 700 V.
 - iv Line to Line: 1200 V.
 - e. SCCR: Equal to the SCCR of the panelboard in which installed.
11. Disconnecting and Overcurrent Protective Devices:
- a. MCCB: Interrupting capacity.
 - i Circuit Breakers: Thermal-magnetic type.
 - ii MCCB Features and Accessories:
 - 1) Lugs: Compression style.
 - 2) Appropriate for Application: Type SWD for switching fluorescent lighting loads; Type HID for feeding fluorescent and HID lighting circuits.
 - 3) Ground-Fault Protection: Integrally mounted relay and trip unit.
 - 4) Communication Capability: Universal-mounted communication module.
 - 5) Shunt Trip: 120-V trip coil.
 - 6) Rating Plugs: Three-pole breakers with ratings greater than 150 A.
 - 7) Auxiliary Contacts: Two SPDT switches.
 - 8) Multipole units enclosed in a single housing with a single handle.
 - b. Type HD fused switch.
12. Identification:
- a. Panelboard labels.
 - b. Breaker labels.
 - c. Circuit Directory: transparent card holder.
13. Accessories:
- a. Accessory set including tools.
 - b. Portable test set.
- C.17.4 Field Quality Control**
- C.17.4.1** Testing: By Contractor-engaged agency.

C.18 Electricity Metering

C.18.1 Software Service Agreement

1. Technical Support: Two years.
2. Upgrade Service: Two years.

C.18.2 Equipment For Electricity Metering By Utility Company

1. Utility-company-compliant, current-transformer cabinets.
2. Meter sockets.

C.18.3 Electricity Meters

1. Accuracy: 0.2 percent of reading.
2. Kilowatt-Hour Meter: Electronic single- and three-phase meters, measuring electricity used. Digital LCD.
3. Kilowatt-Hour/Demand Meter: Electronic single- and three-phase meters, measuring electricity use and demand. Digital LCD, including historic peak demand.
 - a. Demand Signal Communication Interface: Match signal to remote building automation system.
 - b. Programmable contact module.
 - c. Memory Backup: Self-contained to maintain memory throughout power outages of 72 hours, minimum.
4. Data Transmission: Transmit KY pulse data over Class 1 control-circuit conductors in raceway.
5. Software: PC based, suitable for calculation of utility cost allocation.

C.19 Wiring Devices

C.19.1 Products

1. Standard-Grade Receptacles, 125 V, 20 A:
2. Duplex receptacles.
 - a. Tamper-resistant duplex receptacles.
 - b. Weather-resistant duplex receptacles.
 - c. Tamper- and weather-resistant duplex receptacles.
3. USB Receptacles: tamper-resistant duplex (125 V, 20 A) and USB charging receptacles.
4. GFCI Receptacles, 125V, 20A:
5. Duplex GFCI receptacles.
 - a. Tamper-resistant duplex GFCI receptacles.
 - b. Tamper- and weather-resistant GFCI receptacles.
6. Toggle Switches: 120/277 V, 20 A.
7. Switches:
 - a. Single pole.
 - b. Two poles.
 - c. Three way.
 - d. Four way.
 - e. Pilot-light switches.
 - f. Key-operated switches.

- g. Single-pole, double-throw, momentary-contact, center-off switches.
- h. Key-operated, single-pole, double-throw, momentary-contact, center-off switches.
- 8. Decorator-Style Devices: Square face, 20 A.
 - a. Decorator duplex receptacles, 125 V, 20 A.
 - b. Decorator, tamper-resistant, duplex receptacles, 125 V, 20 A.
 - c. Decorator, tamper- and weather-resistant, duplex receptacles, 125 V, 20 A.
- 9. Decorator, single-pole switches, 120/277 V, 20 A.
 - a. Decorator, antimicrobial, single-pole switches, 120/277 V, 20A.
- 10. Timer Light Switch: Digital timer light switch.
- 11. Wall-Box Dimmers:
 - a. Modular, full-wave, solid-state units with slider control.
 - b. LED lamp dimmer switches.
- 12. Wall Plates:
 - a. Material for Finished Spaces: Thermoplastic.
 - b. Material for Unfinished Spaces: Galvanized steel.
 - c. Material for Damp and Wet Locations: Thermoplastic.
- 13. Floor Service Fittings: Modular, dual service, with power receptacle and voice and data communication outlet.
 - a. Type: Flush.
 - b. Service Plate: Rectangular, aluminum.
- 14. Voice and Data Communication Outlet: Two modular, keyed, RJ-45 jacks.
- 15. Poke-Through Assemblies: Below-floor junction box with multi-channeled, through-floor raceway/firestop and detachable floor service-outlet assembly.
- 16. Service-Outlet Assembly: Flush type.
 - a. Size: 3 inches.

C.20 Surge Protection for Low-Voltage Electrical Power Circuits

C.20.1 Summary

Section includes:

- 1. Type 1 SPDs.
- 2. Type 2 SPDs.
- 3. Enclosures.
- 4. Conductors and cables.

C.20.2 Warranty

Materials and Workmanship Warranty for SPDs: Five years.

C.20.3 Type 1 Surge Protective Devices (SPDs)

Standards: UL 1449, Type 1.

Product Options: Include integral disconnect switch.

C.20.4 Type 2 Surge Protective Devices (SPDs)

Standards: UL 1449, Type 2. Comply with UL 1283.

C.20.5 Enclosures

Indoor Enclosures: NEMA 250, Type 1.

Outdoor Enclosures: NEMA 250, Type 4.

C.20.6 Conductors and Cables

Power Wiring: Same size as SPD leads, complying with Section 260519 "Low-Voltage Electrical Power Conductors and Cables."

C.20.7 Installation

Comply with NECA 1.

Provide OCPD and disconnect for installation of SPD according to UL 1449 and manufacturer's written instructions.

Use crimped connectors and splices only. Wire nuts are unacceptable.

C.20.8 Field Quality Control

Perform tests and inspections with the assistance of a factory-authorized service representative.

C.20.9 Startup Service

Complete startup checks according to manufacturer's written instructions.

C.20.10 Demonstration

Train Owner's maintenance personnel to operate and maintain SPDs.

D Measurement

The department will measure General Electrical Work as a single unit for each project, acceptably completed.

E Payment

The department will pay for measured quantities at the contract unit price under the following bid item:

ITEM NUMBER	DESCRIPTION	UNIT
SPV.0060.19	General Electrical Work	EACH

Payment is full compensation for completion of all electrical work described in this bid item.

40. Fire Alarm System, Item SPV.0060.20.

A Description

This special provision describes furnishing materials necessary for the installation, testing, and making fully operational the fire alarm components and systems for the structure, including an emergency responder radio antenna/repeater system (ERRCS). All additional special provisions provide further information, requirements, and guidelines that are applicable to the work paid for under the bid items addressed by this special provision. Contractor shall furnish and install all components necessary to connect new devices to existing fire alarm panel in station.

Comply with all local codes, all laws applying to electrical installations in effect, the regulations of the latest NFPA 72 code.

It is the intention of the contract plans to call for completely finished work, fully tested and ready for reliable and consistent operation. Furnish, deliver, and install any apparatus, appliance, materials, or work not shown on the plans but mentioned in the special provisions or vice versa, or any incidental accessories necessary to make the work complete in all respects and ready for operation, to be furnished, delivered, and installed without additional expense to the department.

B Materials

B.1 System

1. Summary
 - a. System Description: Noncoded, UL-certified addressable system with multiplexed signal transmission.
 - b. Furnish and install all new devices shown on plans and components necessary to connect to existing fire alarm panel in existing station building.
 - c. Furnish and install all required components for ERRCS including: bi-directional amplifiers, donor antenna, indoor coverage antennas, distributed antenna system, coaxial cable, splitters and directional couplers, and battery backup power.
2. Quality Assurance
 - a. Quality Standard: NFPA 72.
 - b. Installer Qualifications: Certified by NICET as fire-alarm technician.
3. Systems Operational Description
 - a. Signal initiation from:
 - i Manual stations.
 - ii Heat detectors.
 - iii Smoke detectors.
 - iv Duct smoke detectors.
 - b. Signal initiates the following actions:
 - i Continuously operate alarm notification appliances.
 - ii Identify alarm at the fire-alarm control unit, connected network control panels and remote annunciators.
 - iii Transmit an alarm signal to the remote alarm receiving station.
 - iv Unlock electric door locks in designated egress paths.
 - v Release fire and smoke doors held open by magnetic door holders.
 - vi Activate voice/alarm communication system.
 - vii Switch heating, ventilating, and air-conditioning equipment controls to fire-alarm mode.
 - viii Close smoke dampers in air ducts of designated air-conditioning duct systems.
 - ix Recall elevators.
 - x Activate elevator power shunt trip.
 - xi Activate emergency lighting control.
 - xii Activate emergency shutoffs for building gas and fuel supplies.
 - xiii Record events in the system memory.
 - xiv Record events by the system printer.
 - xv Indicate device in alarm on the graphic annunciator.
 - c. Supervisory signal initiation by:
 - i Valve supervisory switch.
 - ii Alert and Action signals of air-sampling detector system.
 - iii Elevator shunt-trip supervision.
 - iv Independent fire-detection and -suppression systems.

- v User disabling of zones or individual devices.
 - vi Loss of communication with any panel on the network.
- d. Trouble signal initiation by:
- i Open circuits, shorts, and grounds, in designated circuits.
 - ii Opening, tampering with, or removing alarm-initiating and supervisory signal-initiating devices.
 - iii Loss of communication with any addressable sensor, input module, relay, control module, remote annunciator, printer interface, or Ethernet module.
 - iv Loss of primary power at fire-alarm control unit.
 - v Ground or a single break in fire-alarm control unit internal circuits.
 - vi Abnormal ac voltage at fire-alarm control unit.
 - vii Break in standby battery circuitry.
 - viii Failure of battery charging.
 - ix Abnormal position of any switch at the fire-alarm control unit or annunciator.
 - x Voice signal amplifier failure.
 - xi Hose cabinet door open.
- e. System Trouble and Supervisory Signal Actions: Initiate notification appliances and annunciate at fire-alarm control unit and remote annunciators. Record the event on system printer.

B.2 Products

1. Fire-Alarm Control Unit: Field-programmable, microprocessor-based, modular, power-limited design with electronic modules, addressable initiation device circuits, and addressable control circuits.
 - a. Alphanumeric liquid-crystal display with one line(s) of 40 characters and system controls and keypad.
2. Smoke-alarm verification.
3. Manual Fire-Alarm Boxes: Single action.
4. System Smoke Detectors: Base mounted, self-restoring, with integral visual-indicating light.
5. Projected beam smoke detectors.
6. Non-system single-station smoke detectors.
7. Heat Detectors: Combination type.
8. Carbon monoxide detector.
9. Multicriteria detectors.
10. Air-sampling smoke detector.
11. Elevator recall initiated by elevator lobby, elevator machine room, or elevator hoistway detectors.
12. Notification Appliances:
 - a. Audible appliances.
 - b. Low-level output chimes.
 - c. Electric-vibrating-polarized type, 24-V dc horns.
 - d. Xenon strobe lights.

- e. Flush-mounted voice/tone speakers.
 - f. Exit marking audible notification appliance.
13. Firefighters' telephones.
 14. Magnetic Door Holders: Wall- or floor-mounted units;
 15. Graphic annunciator.
 16. Remote annunciator.
 17. Addressable Interface Device: Microelectronic monitor module with integral relay.
 18. Digital alarm transmitter.
 19. System printer.
 20. Welded wire mesh device guards.
 21. Network communications for fire-alarm system interconnection.
 22. Maintenance Service: 12 months' full maintenance.

C Construction

C.1 General

Install systems according to manufacturer's recommendations and Authority Having Jurisdiction (AHJ) requirements.

D Measurement

The department will measure Fire Alarm System as a single unit for each project, acceptably installed.

E Payment

The department will pay for measured quantities at the contract unit price under the following bid item:

ITEM NUMBER	DESCRIPTION	UNIT
SPV.0060.20	Fire Alarm System	EACH

Payment is full compensation for performing all the work required to construct the fire alarm system.

41. Lightning Protection for Structures, Item SPV.0060.21.

A Description

This special provision describes providing the lightning protection system. This special provision describes furnishing materials necessary for the installation, testing, and making fully operational the lightning protection components and systems for the structure. All additional special provisions provide further information, requirements, and guidelines that are applicable to the work paid for under the bid items addressed by this special provision.

It is the intention of the contract plans to call for completely finished work, fully tested and ready for reliable and consistent operation. Furnish, deliver, and install any apparatus, appliance, materials, or work not shown on the plans but mentioned in the special provisions or vice versa, or any incidental accessories necessary to make the work complete in all respects and ready for operation, to be furnished, delivered, and installed without additional expense to the department.

B Materials

B.1 Performance Requirements

1. Lightning Protection Standard: NFPA 780 UL 96A for Class II buildings.
2. Components: UL 96.

B.2 Components

1. Roof-Mounting Air Terminals: Copper.
2. Ground Rods: Copper-clad steel.
3. Main Conductors: Class II.

C Construction

C.1 Installer Requirements: UL-listed installer, category OWAY

Comply with all local codes, all laws applying to electrical installations in effect, the regulations of the latest National Electrical and energy codes.

Conductors to Be Concealed:

1. System conductors.
2. Down conductors.
 - a. Interior conductors.
 - b. Conductors within normal view of exterior locations at grade.
 - i Ground loop.
 - ii Ground ring.
 - iii Lightning protection components bonded with intermediate-level interconnection loop conductors at 60-foot intervals.

C.2 Field Quality Control

1. Inspection: UL Master Label Certificate.

D Measurement

The department will measure Lightning Protection for Structures by each structure, acceptably completed.

E Payment

The department will pay for measured quantities at the contract unit price under the following bid item:

ITEM NUMBER	DESCRIPTION	UNIT
SPV.0060.21	Lighting Protection for Structures	EACH

Payment is full compensation for performing all the work required to construct the lightning protection system.

42. Plumbing Work, Item SPV.0060.22.

A Description

This special provision describes providing a complete functioning plumbing system including but not limited to the installation of the domestic water piping, roof drainage system, sanitary sewer system, sump pumps, water heaters and natural gas piping systems.

A.1 Regulatory Requirements

1. State and Local Codes
2. Conform to all state and local code requirements.
3. Permits and Inspections
4. Obtain permits and request inspections from authority having jurisdiction and pay for all Permit fees incidental thereto.

A.2 Plumbing Installations

Coordinate plumbing systems installation with other building components. Verify all dimensions by field measurements. Arrange for chases, slots and openings in other building components to allow for piping installations. Install piping to facilitate maintenance and repair or replacement of equipment and accessories.

A.3 Delivery, Storage and Handling

Deliver plumbing materials with appropriate protective packaging with labels in place. Deliver pipes and tube with factory-applied end caps. Maintain end caps through shipping, storage and handling to prevent pipe end damage and to prevent entrance of dirt, debris and moisture.

A.4 References

National Fire Protection Association (NFPA)

1. NFPA 54 (ANSI Z223.1) National Fuel Gas Code.
2. NFPA 255 Building Materials, Test of Surface Burning Characteristics.

American Society for Testing & Materials (ASTM)

3. ASTM C612 Specification for Mineral Fiber Block and Board Thermal Insulation.
4. ASTM B32 Specification for Solder Metal
5. ASTM A90 Test Method for Weight of Coating on Zinc-Coated (Galvanized Iron or Steel Articles.
6. ASTM A527 Specification for Steel Sheet, Zinc-Coated (Galvanized) by the Hot Dip Process, Lock Forming Quality.
7. ASTM C553 Specification for Mineral Fiber Blanket and Felt Insulation (Industrial Type).

Underwriters Laboratories (UL)

8. UL 723 Test for Surface Burning Characteristics of Building Materials.

American National Standards Institute (ANSI)

9. ANSI/ASME B16.22 Wrought Copper and Copper Alloy Solder-Joint Pressure Fittings.
10. ANSI/ASHRAE 90a Energy Conservation in New Building Design.

A.5 Submittals

A.5.1 Equipment and Material Shop Drawings

Submit shop drawings which include equipment information and product data for equipment listed below for review:

1. Plumbing Systems and accessories
 - a. Plans and details for entire plumbing installation
 - b. Piping and fitting materials
 - c. All system specialties (drains, cleanouts, pressure regulators, etc.)
 - d. Valves
 - e. Sump pumps, including controls and pit cover
 - f. Electric Water Heater
 - g. Piping and equipment hangers/supports
 - h. Sleeves and escutcheons.
 - i. Piping and valve identifications

B Materials

B.1 Domestic Water Piping.

B.1.1 Pipe -General

Potable-water piping and components shall comply with NSF 14, NSF 61, and NSF 372. Include marking "NSF-pw" on piping.

B.1.1.1 Manufacturers

1. Subject to compliance with requirements, provide products by one of the following:
 - a. Elkhart Products Corporation.
 - b. NIBCO Inc.
 - c. Viega.

B.1.2 Copper Tubes

Hard Copper Tube: ASTM B 88, Type L water tube, drawn temper.

B.1.2.1 Copper tube joints and Fittings

1. Cast-Copper, Solder-Joint Fittings: ASME B16.18, pressure fittings.
2. Wrought-Copper, Solder-Joint Fittings: ASME B16.22, wrought-copper pressure fittings.
3. Flanges in "Bronze Flanges" Paragraph below are available in NPS 1/2 to NPS 3.
4. Bronze Flanges: ASME B16.24, Class 150, with solder-joint ends.
5. Copper Unions: MSS SP-123. Cast-copper-alloy, hexagonal-stock body, Ball-and-socket, metal-to-metal seating surfaces. Solder-joint or threaded ends.
6. Fittings: Cast-brass, cast-bronze or wrought-copper with EPDM O-ring seal in each end.

B.1.3 Transition Fittings

1. Same size as pipes to be joined
2. Pressure rating at least equal to pipes to be joined
3. End connections compatible with pipes to be joined.

B.1.4 Dielectric Fittings

1. Assembly of copper alloy and ferrous materials with separating nonconductive insulating material. Include end connections compatible with pipes to be joined.

B.2 Domestic Water Piping Specialties.

B.2.1 General

1. Minimum Working Pressure for Domestic Water Piping Specialties: 125 psig unless otherwise indicated.

B.2.2 Manufacturers

1. Subject to compliance with requirements, provide products by one of the following:
 - a. Josam Company.
 - b. Smith, Jay R. Mfg. Co.; Division of Smith Industries, Inc.
 - c. WATTS.
 - d. Woodford Manufacturing Company.
 - e. Zurn Industries, LLC.

B.2.3 Non-freeze Wall Hydrant

1. Standard: ASME A112.21.3M for concealed-outlet, self-draining wall hydrants.
 - a. Pressure Rating: 125 psig.
 - b. Operation: Loose key.
 - c. Casing and Operating Rod: Of length required to match wall thickness. Include wall clamp.
 - d. Inlet: NPS 3/4 or NPS 1.
 - e. Outlet: Concealed, with integral vacuum breaker and garden-hose thread complying with ASME B1.20.7.
 - f. Box: Deep, flush mounted with cover.
 - g. Box and Cover Finish: Polished nickel bronze Retain "Outlet," "Box," and "Box and Cover Finish" subparagraphs above for concealed-outlet-type wall hydrants or "Outlet" and "Nozzle and Wall-Plate Finish" subparagraphs below for exposed-outlet-type wall hydrants.
 - h. Outlet: Exposed, with integral vacuum breaker and garden-hose thread complying with ASME B1.20.7.
 - i. Nozzle and Wall-Plate Finish: Polished nickel bronze.
 - j. Operating Keys(s): Two with each wall hydrant.

B.2.4 Ball Valve Type Hose-end Drain Valves

1. Standard: MSS SP-110 for standard-port, two-piece ball valves.
 - a. Pressure Rating: 400-psig minimum CWP.
 - b. Size: NPS 3/4.
 - c. Body: Copper alloy.
 - d. Ball: Chrome-plated brass.
 - e. Seats and Seals: Replaceable.
 - f. Handle: Vinyl-covered steel.
 - g. Inlet: Threaded or solder joint.
 - h. Outlet: Threaded, short nipple with garden-hose thread complying with ASME B1.20.7 and cap with brass chain.

B.3 Sanitary Waste and Vent Piping

B.3.1 Performance Requirements

1. Components and installation shall be capable of withstanding the following minimum working pressure unless otherwise indicated:
 - a. Soil, Waste, and Vent Piping: 10-foot head of water.
 - b. Waste, Force-Main Piping: 50 psig.
2. Seismic Performance: Soil, waste, and vent piping and support and installation shall withstand the effects of earthquake motions determined according to ASCE/SEI 7.

B.3.2 Piping Materials - General

1. Piping materials shall bear label, stamp, or other markings of specified testing agency.
2. Comply with requirements in "Piping Schedule" Article for applications of pipe, tube, fitting materials, and joining methods for specific services, service locations, and pipe sizes.

B.3.2.2 Hub and Spigot, Cast-Iron Pipe and Fittings

1. Manufacturers: Subject to compliance with requirements, provide products by one of the following:
 - a. AB&I Foundry; a part of McWane family
 - b. Charlotte Pipe and Foundry
 - c. Tyler Pipe; a part of McWane family
2. Pipe and fittings in this article are available in NPS 2 to NPS 6.
3. Pipe and Fittings: ASTM A 74, Service and Extra Heavy class(es).
4. Gaskets: ASTM C 564, rubber.
5. Caulking Materials: ASTM B 29, pure lead and oakum or hemp fiber.

B.3.2.3 Hubless, Cast-Iron Soil Pipe and Fittings

1. Manufacturers: Subject to compliance with requirements, provide products by one of the following:
 - a. AB&I Foundry; a part of McWane family
 - b. Charlotte Pipe and Foundry
 - c. Tyler Pipe; a part of McWane family
2. Pipe and Fittings: ASTM A 888 or CIPSI 301
3. CISPI, Hubless-Piping Couplings: Subject to compliance with requirements, provide products by one of the following
 - a. Manufacturers:
 - i. ANACO-Husky.
 - ii. Charlotte Pipe and Foundry
 - iii. Fernco Inc.
 - iv. Mission Rubber Co, LLC
 - v. MIFAB, Inc.
 - vi. Tyler Pipe.
 - b. Standards: ASTM C 1277 and CISPI 310.
 - c. Description: Stainless-steel corrugated shield with stainless-steel bands and tightening devices; and ASTM C 564, rubber sleeve with integral, center pipe stop.
4. Heavy-Duty, Hubless-Piping Couplings: Subject to compliance with requirements, provide products by one of the following manufacturers:
 - i. ANACO-Husky.
 - ii. Charlotte Pipe and Foundry
 - iii. Fernco Inc.
 - iv. Mission Rubber Co, LLC
 - v. MIFAB, Inc.
 - vi. Tyler Pipe.
 - b. Standards: ASTM C 1277 and ASTM C 1540
 - c. Description: Stainless-steel shield with stainless-steel bands and tightening devices; and ASTM C 564, rubber sleeve with integral, center pipe stop.

5. Heavy-Duty, Hubless-Piping Couplings:
 - a. Subject to compliance with requirements, provide products by one of the following manufacturers:
 - i Charlotte Pipe and Foundry
 - 1) MG Piping Products Company
 - b. Standards: ASTM C 1277
 - c. Description: Two-piece ASTM A 48/A 48M, cast-iron housing; stainless-steel bolts and nuts; and ASTM C 564, rubber sleeve with integral, center pipe stop.

B.3.2.4 Galvanized Steel Pipe and Fittings

1. Galvanized-Steel Pipe: ASTM A 53/A 53M, Type E, Standard Weight class. Include square-cut-grooved or threaded ends matching joining method.

Galvanized-Cast-Iron Drainage Fittings: ASME B16.12, threaded.

Steel Pipe Pressure Fittings:

2. Galvanized-Steel Pipe Nipples: ASTM A 733, made of ASTM A 53/A 53M or ASTM A 106/A 106M, Schedule 40, seamless steel pipe. Include ends matching joining method.
3. Malleable-Iron Unions: ASME B16.39; Class 150; hexagonal-stock body with ball-and-socket, metal-to-metal, bronze seating surface; and female threaded ends.
 - a. Galvanized-Gray-Iron, Threaded Fittings: ASME B16.4, Class 125, standard pattern.

Cast-Iron Flanges: ASME B16.1, Class 125

4. Flange Gasket Materials: ASME B16.21, full-face, flat, nonmetallic, asbestos-free, 1/8-inch maximum thickness unless thickness or specific material is indicated.
5. Flange Bolts and Nuts: ASME B18.2.1, carbon steel unless otherwise indicated.

Grooved Joint, Galvanized-Steel-Pipe Appurtenances

6. Manufacturers: Subject to compliance with requirements, provide products by one of the following:
 - a. Anvil International
 - b. Grinnel G-Fire by Johnson Controls Company
 - c. Shurjoint-Apollo Piping Products, USA, Inc.
 - d. Smith-Cooper International.
 - e. Victaulic Company
7. Galvanized, Grooved-End Fittings for Galvanized-Steel Piping: ASTM A 536 ductile-iron castings, ASTM A 47/A 47M malleable-iron castings, ASTM A 234/A 234M forged steel fittings, or ASTM A 106/A 106M steel pipes with dimensions matching ASTM A 53/A 53M steel pipe, and complying with AWWA C606 for grooved ends.
8. Grooved Mechanical Couplings for Galvanized-Steel Piping: ASTM F 1476, Type I. Include ferrous housing sections with continuous curved keys; EPDM-rubber gasket suitable for hot and cold water; and bolts and nuts.

B.3.2.5 Specialty Pipe Fittings

1. Transition Couplings:
 - a. Fitting-Type Transition Couplings: Manufactured piping coupling or specified piping system fitting.

2. Unshielded, Nonpressure Transition Couplings:
 - a. Standard: ASTM C 1173.
 - b. Description: Elastomeric, sleeve-type, reducing or transition pattern. Include shear ring and corrosion-resistant-metal tension band and tightening mechanism on each end.
 - c. End Connections: Same size as and compatible with pipes to be joined.
 - d. Sleeve Materials:
 - i For Cast-Iron Soil Pipes: ASTM C 564, rubber.
 - ii For Dissimilar Pipes: ASTM D 5926, PVC or other material compatible with pipe materials being joined.
3. Shielded, Nonpressure Transition Couplings:
 - a. Standard: ASTM C 1460.
 - b. Description: Elastomeric or rubber sleeve with full-length, corrosion-resistant outer shield and corrosion-resistant-metal tension band and tightening mechanism on each end.
 - c. End Connections: Same size as and compatible with pipes to be joined.
4. Pressure Transition Couplings:
 - a. Standard: AWWA C219.
 - b. Description: Metal, sleeve-type same size as, with pressure rating at least equal to, and ends compatible with, pipes to be joined.
 - c. Center-Sleeve Material: Manufacturer's standard.
5. Dielectric Fittings
 - a. Dielectric Unions:
 - i Standard: ASSE 1079.
 - ii Pressure Rating: 125 psig minimum at 180 deg F.
 - b. Dielectric Flanges:
 - i Standard: ASSE 1079.
 - ii Factory-fabricated, bolted, companion-flange assembly.
 - iii Pressure Rating: 125 psig minimum at 180 deg F.

B.4 Sanitary Waste Piping Specialties

B.4.1 Assembly Description

1. Sanitary waste piping specialties shall bear label, stamp, or other markings of specified testing agency.

B.4.2 Cleanouts

B.4.2.1 Cleanout Manufacturers

1. Josam Company; Josam Div.
2. Jay R. Smith Mfg. Co; a division of Morris Group International.
3. MIFAB, Inc.
4. Tyler Pipe; a subsidiary of McWane.
5. WATTS
6. Zurn Industries, LLC.

B.4.2.2 Cast-Iron Exposed Cleanouts

1. Standard: ASME A112.36.2M.
2. Size: Same as connected drainage piping
3. Body Material: Hub-and-spigot, cast-iron soil pipe T-branch as required to match connected piping.
4. Closure: Countersunk, brass plug.
5. Closure Plug Size: Same as or not more than one size smaller than cleanout size.

B.4.2.3 Cast-Iron Exposed Floor Cleanouts

1. Standard: ASME A112.36.2M for cast-iron soil pipe with cast-iron ferrule heavy-duty, adjustable housing cleanout.
2. Size: Same as connected branch.
3. Type: Cast-iron soil pipe with cast-iron ferrule Heavy-duty, adjustable housing.
4. Body or Ferrule: Cast iron.
5. Clamping Device: Required.
6. Outlet Connection: Spigot.
7. Closure: Brass plug with straight threads and gasket.
8. Adjustable Housing Material: Cast iron with threads.
9. Frame and Cover Material and Finish: Nickel-bronze, copper alloy.
10. Frame and Cover Shape: Round.
11. Top Loading Classification: Heavy Duty.
12. Riser: ASTM A74, Extra-Heavy class, cast-iron drainage pipe fitting and riser to cleanout.

B.4.2.4 Cast-Iron Wall Cleanouts

1. Standard: ASME A112.36.2M. Include wall access.
2. Size: Same as connected drainage piping.
3. Body: Hub-and-spigot, cast-iron soil pipe T-branch as required to match connected piping.
4. Closure Plug:
 - a. Brass.
 - b. Countersunk or raised head.
 - c. Drilled and threaded for cover attachment screw.
 - d. Size: Same as or not more than one size smaller than cleanout size.
5. Wall Access: Round, flat, chrome-plated brass or stainless-steel cover plate with screw.
6. Wall Access: Round, nickel-bronze, copper-alloy, or stainless-steel wall-installation frame and cover.

B.4.3 Roof flashing Assembly

B.4.3.1 Manufacturers

1. [Acorn Engineering Co.](#)
2. [Thaler Metal Industries, LLC](#)
3. [Zurn Industries, LLC.](#)

B.4.3.2 Assembly Description

1. Manufactured assembly made of 6.0-lb/sq. ft. 0.0938-inch- thick, lead flashing collar and skirt extending at least 8 inches from pipe, with galvanized-steel boot reinforcement and counterflashing fitting.

B.4.4 Through-Penetration Fire Stop Assemblies

1. Manufacturers: Subject to compliance with requirements, provide products by ProVent Systems.
 - a. or equal
2. Standard: UL 1479 assembly of sleeve-and-stack fitting with firestopping plug.
3. Size: Same as connected soil, waste, or vent stack.
4. Sleeve: Molded-PVC plastic, of length to match slab thickness and with integral nailing flange on one end for installation in cast-in-place concrete slabs.

B.4.5 Miscellaneous Sanitary Drainage Piping Specialties

B.4.5.1 Open Drain

1. Description: Shop or field fabricate from ASTM A74, Service class, hub-and-spigot, cast-iron soil-pipe fittings. Include P-trap, hub-and-spigot riser section; and where required, increaser fitting joined with ASTM C564 rubber gaskets.

B.4.5.2 Deep-Seal Traps

1. Description: Cast-iron or bronze casting, with inlet and outlet matching connected piping and cleanout trap-seal primer valve connection.
2. Size: Same as connected waste piping.
 - a. NPS 2 : 4-inch- minimum water seal.
 - b. NPS 2-1/2 and Larger: 5-inch- (minimum water seal).

B.4.5.3 Air-Gap Fittings

1. Standard: ASME A112.1.2, for fitting designed to ensure fixed, positive air gap between installed inlet and outlet piping.
2. Body: Bronze or cast iron.
3. Inlet: Opening in top of body.
4. Outlet: Larger than inlet.
5. Size: Same as connected waste piping and with inlet large enough for associated indirect waste piping.

B.4.5.4 Sleeve Flashing Device

1. Standard: ASME A112.1.2, for fitting designed to ensure fixed, positive air gap between installed inlet
Description: Manufactured, cast-iron fitting, with clamping device that forms sleeve for pipe floor penetrations of floor membrane. Include galvanized-steel pipe extension in top of fitting that will extend 2 inches above finished floor and galvanized-steel pipe extension in bottom of fitting that will extend through floor slab.
2. Size: As required for close fit to riser or stack piping.

B.4.5.5 Stack Flashing Fittings

1. Standard: ASME A112.1.2, for fitting designed to ensure fixed, positive air gap between installed inlet
Description: Counterflashing-type, cast-iron fitting, with bottom recess for terminating roof membrane, and with threaded or hub top for extending vent pipe.
2. Size: Same as connected stack vent or vent stack.

B.4.5.6 Vent Caps

1. Description: Cast-iron body with threaded or hub inlet and vandal-proof design. Include vented hood and setscrews to secure to vent pipe.
2. Size: Same as connected stack vent or vent stack.

B.4.5.7 Frost Resistant Vent Terminals

1. Description: Manufactured or shop-fabricated assembly constructed of copper, lead-coated copper, or galvanized steel.
2. Design: To provide 1-inch enclosed air space between outside of pipe and inside of flashing collar extension, with counterflashing.

B.4.5.8 Expansion Joints

1. Standard: ASME A112.6.4.
2. Body: Cast iron with bronze sleeve, packing, and gland.
3. End Connections: Matching connected piping.
4. Size: Same as connected soil, waste, or vent piping.

B.5 Storm Drainage Piping

B.5.1 Performance Requirements

1. Components and installation shall be capable of withstanding the following minimum working pressure
2. unless otherwise indicated:
 - a. Soil, Waste, and Vent Piping: 10-foot head of water.

B.5.2 Piping Materials - General

1. Piping materials shall bear label, stamp, or other markings of specified testing agency.
2. Comply with requirements in "Piping Schedule" Article for applications of pipe, tube, fitting materials, and joining methods for specific services, service locations, and pipe sizes.

B.5.2.2 Hub and Spigot, Cast-Iron Pipe and Fittings

1. Manufacturers: Subject to compliance with requirements, provide products by one of the following:
 - a. AB&I Foundry; a part of McWane family
 - b. Charlotte Pipe and Foundry
 - c. Tyler Pipe; a part of McWane family
2. Pipe and fittings in this article are available in NPS 2 to NPS 6.
3. Pipe and Fittings: ASTM A 74, Service and Extra Heavy class(es).
4. Gaskets: ASTM C 564, rubber.
5. Caulking Materials: ASTM B 29, pure lead and oakum or hemp fiber.

B.5.2.3 Hubless, Cast-Iron Soil Pipe and Fittings

1. Manufacturers: Subject to compliance with requirements, provide products by one of the following:
 - a. AB&I Foundry; a part of McWane family
 - b. Charlotte Pipe and Foundry
 - c. Tyler Pipe; a part of McWane family
2. Pipe and Fittings: ASTM A 888 or CIPSI 301

3. CISPI, Hubless-Piping Couplings: Subject to compliance with requirements, provide products by one of the following Manufacturers:
 - a. ANACO-Husky.
 - b. Charlotte Pipe and Foundry
 - c. Fernco Inc.
 - d. Mission Rubber Co, LLC
 - e. MIFAB, Inc.
 - f. Tyler Pipe.
4. Standards: ASTM C 1277 and CISPI 310.
5. Description: Stainless-steel corrugated shield with stainless-steel bands and tightening devices; and ASTM C 564, rubber sleeve with integral, center pipe stop.
6. Heavy-Duty, Hubless-Piping Couplings: Subject to compliance with requirements, provide products by one of the following manufacturers:
 - a. ANACO-Husky.
 - b. Charlotte Pipe and Foundry
 - c. Fernco Inc.
 - d. Mission Rubber Co, LLC
 - e. MIFAB, Inc.
 - f. Tyler Pipe.
7. Standards: ASTM C 1277 and ASTM C 1540
8. Description: Stainless-steel shield with stainless-steel bands and tightening devices; and ASTM C 564, rubber sleeve with integral, center pipe stop.
9. Heavy-Duty, Hubless-Piping Couplings: Subject to compliance with requirements, provide products by one of the following manufacturers:
 - a. Charlotte Pipe and Foundry
 - b. MG Piping Products Company
10. Standards: ASTM C 1277
11. Description: Two-piece ASTM A 48/A 48M, cast-iron housing; stainless-steel bolts and nuts; and ASTM C 564, rubber sleeve with integral, center pipe stop.

B.5.2.4 Galvanized Steel Pipe and Fittings

1. Galvanized-Steel Pipe: ASTM A 53/A 53M, Type E, Standard Weight class. Include square-cut-grooved or threaded ends matching joining method.

Galvanized-Cast-Iron Drainage Fittings: ASME B16.12, threaded.

Steel Pipe Pressure Fittings:

2. Galvanized-Steel Pipe Nipples: ASTM A 733, made of ASTM A 53/A 53M or ASTM A 106/A 106M, Schedule 40, seamless steel pipe. Include ends matching joining method.
3. Malleable-Iron Unions: ASME B16.39; Class 150; hexagonal-stock body with ball-and-socket, metal-to-metal, bronze seating surface; and female threaded ends.
4. Galvanized-Gray-Iron, Threaded Fittings: ASME B16.4, Class 125, standard pattern.

Cast-Iron Flanges: ASME B16.1, Class 125

5. Flange Gasket Materials: ASME B16.21, full-face, flat, nonmetallic, asbestos-free, 1/8-inch maximum thickness unless thickness or specific material is indicated.

6. Flange Bolts and Nuts: ASME B18.2.1, carbon steel unless otherwise indicated.

Grooved Joint, Galvanized-Steel-Pipe Appurtenances

7. Manufacturers: Subject to compliance with requirements, provide products by one of the following:
8. Anvil International
9. Grinnel G-Fire by Johnson Controls Company
10. Shurjoint-Apollo Piping Products, USA, Inc.
11. Smith-Cooper International.
12. Victaulic Company
 - a. Galvanized, Grooved-End Fittings for Galvanized-Steel Piping: ASTM A 536 ductile-iron castings, ASTM A 47/A 47M malleable-iron castings, ASTM A 234/A 234M forged steel fittings, or ASTM A 106/A 106M steel pipes with dimensions matching ASTM A 53/A 53M steel pipe, and complying with AWWA C606 for grooved ends.
 - b. Grooved Mechanical Couplings for Galvanized-Steel Piping: ASTM F 1476, Type I. Include ferrous housing sections with continuous curved keys; EPDM-rubber gasket suitable for hot and cold water; and bolts and nuts.

B.5.2.5 Specialty Pipe Fittings

1. Transition Couplings:
 - a. Fitting-Type Transition Couplings: Manufactured piping coupling or specified piping system fitting.
2. Unshielded, Nonpressure Transition Couplings:
 - a. Standard: ASTM C 1173.
 - b. Description: Elastomeric, sleeve-type, reducing or transition pattern. Include shear ring and corrosion-resistant-metal tension band and tightening mechanism on each end.
 - c. End Connections: Same size as and compatible with pipes to be joined.
 - d. Sleeve Materials:
 - i For Cast-Iron Soil Pipes: ASTM C 564, rubber.
 - ii For Dissimilar Pipes: ASTM D 5926, PVC or other material compatible with pipe materials being joined.
3. Shielded, Nonpressure Transition Couplings:
 - a. Standard: ASTM C 1460.
 - b. Description: Elastomeric or rubber sleeve with full-length, corrosion-resistant outer shield and corrosion-resistant-metal tension band and tightening mechanism on each end.
 - c. End Connections: Same size as and compatible with pipes to be joined.
4. Dielectric Fittings
 - a. Dielectric Unions:
 - i Standard: ASSE 1079.
 - ii Pressure Rating: 125 psig minimum at 180 deg F.
 - b. Dielectric Flanges:
 - i Standard: ASSE 1079.
 - ii Factory-fabricated, bolted, companion-flange assembly.
 - iii Pressure Rating: 125 psig minimum at 180 deg F.

B.6 Storm Drainage Specialties

1. Refer to the Drain Schedule on the Contract drawings for additional information.

B.6.2 Metal Roof Drain

1. Manufacturers: Subject to compliance with requirements, provide products by one of the following:
 - a. Josam Company; Josam Div.
 - b. Jay R. Smith Mfg. Co; a division of Morris Group International.
 - c. WATTS
 - d. Zurn Industries, LLC.
2. Cast-Iron, Large-Sump, General-Purpose Roof Drains:
 - a. Standard: ASME A112.6.4.
 - b. Body Material: Cast iron.
 - c. Dimension of Body: Nominal 14-to 16-inch diameter.
 - d. Combination Flashing Ring and Gravel Stop: Required.
 - e. Outlet: Bottom.
 - f. Outlet Type: No hub.
 - g. Underdeck Clamp: Required.
 - h. Dome Material: Cast iron.
 - i. Water Dam: Not required for overflow drain installation
3. Cast-Iron, Medium-Sump, General-Purpose Roof Drains:
 - a. Standard: ASME A112.6.4.
 - b. Body Material: Cast iron.
 - c. Dimension of Body: 8- to 12-inch diameter.
 - d. Combination Flashing Ring and Gravel Stop: Required.
 - e. Outlet: Bottom.
 - f. Outlet Type: No hub.
 - g. Underdeck Clamp: Required.
 - h. Dome Material: Cast iron.
 - i. Water Dam: Not required for overflow drain installation
4. Cast-Iron, Small-Sump, General-Purpose Roof Drains:
 - a. Standard: ASME A112.6.4.
 - b. Body Material: Cast iron.
 - c. Dimension of Body: Nominal 8-inch diameter.
 - d. Combination Flashing Ring and Gravel Stop: Required.
 - e. Outlet: Bottom.
 - f. Outlet Type: No hub.
 - g. Underdeck Clamp: Required.
 - h. Dome Material: Cast iron.
 - i. Vandal-Proof Dome: Not required.

B.6.3 Cleanouts

1. Manufacturers: Subject to compliance with requirements, provide products by one of the following:
 - a. Josam Company; Josam Div.
 - b. Jay R. Smith Mfg. Co; a division of Morris Group International.
 - c. MIFAB, Inc.
 - d. WATTS
 - e. Zurn Industries, LLC.
2. Cast-Iron Exposed Cleanouts:
 - a. Standard: ASME A112.36.2M.
 - b. Size: Same as connected branch.
 - c. Body Material: Hub-and-spigot, cast-iron soil pipe T-branches required to match connected piping.
 - d. Closure: Countersunk or raised-head, brass plug.
 - e. Closure Plug Size: Same as, or not more than, one size smaller than cleanout size.
3. Cast-Iron Exposed Floor Cleanouts:
 - a. Standard: ASME A112.36.2M.
 - b. Size: Same as connected branch.
 - c. Type: Cast-iron soil pipe with cast-iron ferrule Heavy-duty, adjustable housing.
 - d. Body or Ferrule: Cast iron.
 - e. Clamping Device: Required.
 - f. Outlet Connection: Hub with gasket.
 - g. Closure: Brass plug with straight threads and gasket.
 - h. Adjustable Housing Material: Cast iron with threads.
 - i. Frame and Cover Material and Finish: Nickel-bronze, copper alloy.
 - j. Frame and Cover Shape: Round.
 - k. Top Loading Classification: Heavy Duty.
 - l. Riser: ASTM A74, Extra-Heavy class, cast-iron drainage pipe fitting and riser to cleanout.
4. Cast-Iron Wall Cleanouts:
 - a. Standard: ASME A112.36.2M. Include wall access.
 - b. Size: Same as connected drainage piping.
 - c. Body: Hub-and-spigot, cast-iron soil pipe T-branch as required to match connected piping.
 - d. Closure Plug:
 - i Brass.
 - ii Countersunk or raised head.
 - iii Drilled and threaded for cover attachment screw.
 - iv Size: Same as, or not more than, one size smaller than cleanout size.
 - e. Wall Access: Round, flat, chrome-plated brass cover plate with screw.
 - f. Wall Access: Round, nickel-bronze wall-installation frame and cover.

5. Test Tees:
 - a. Standard: ASME A112.36.2M and ASTM A74, ASTM A888, or CISPI 301.
 - b. Size: Same as connected drainage piping.
 - c. Body Material: Hub-and-spigot, cast-iron soil-pipe T-branch or no-hub, cast-iron soil-pipe test tee as required to match connected piping.
 - d. Closure Plug: Countersunk or raised head, brass.
 - e. Closure Plug Size: Same as, or not more than, one size smaller than cleanout size.

B.7 Sump Pumps

1. Refer to the Plumbing Equipment Schedule on the Contract drawings for additional information.

B.7.2 Performance Requirements

1. Electrical Components, Devices, and Accessories: Listed and labeled as defined in NFPA 70, by a qualified testing agency, and marked for intended location and application.
 - a. UL Compliance: Comply with UL 778 for motor-operated water pumps.

B.7.3 Submersible Sump Pumps

1. Manufacturers: Subject to compliance with requirements, provide products by one of the following:
 - a. Bell & Gossett Domestic Pump; A Xylem brand.
 - b. Goulds Pumps; Water Technology.
 - c. Grundfos Pumps Corp.
 - d. Pentair Pump Group.
 - e. Weil Pump Company, Inc.
 - f. Liberty Pumps, Inc.
 - g. Zoeller Pump Co.
 - i Description: Fixed Position, Single Seal Factory-assembled and -tested sump-pump unit.
 - ii Pump Type: Submersible, end-suction, single-stage, close-coupled, overhung-impeller, centrifugal sump pump as defined in HI 1.1-1.2 and HI 1.3.
 - iii Pump Casing: Cast iron, with strainer inlet, legs that elevate pump to permit flow into impeller, and vertical discharge for piping connection.
 - iv Impeller: Statically and dynamically balanced, ASTM A48/A48M, Class No. 25 A cast iron, semi-open design for clear wastewater handling, and keyed and secured to shaft.
 - v Pump and Motor Shaft: Stainless steel or steel, with factory-sealed, grease-lubricated ball bearings.
 - vi Seal: Mechanical.
 - vii Motor: Hermetically sealed, capacitor-start type; with built-in overload protection; lifting eye or lug; and three-conductor, waterproof power cable of length required and with grounding plug and cable-sealing assembly for connection at pump.
 - 1) Motor Housing Fluid: Oil.
 - viii Controls:
 - 1) Enclosure: NEMA 250, Type 1.
 - 2) Switch Type: Pedestal-mounted float switch with float rods and rod buttons.
 - 3) Automatic Alternator: Start pumps on successive cycles and start multiple pumps if one cannot handle load.

- 4) Float Guides: Pipe or other restraint for floats and rods in basins of depth greater than 60 inches.
- 5) High-Water Alarm: Cover-mounted, compression-probe alarm, with electric bell; 120 V ac, with transformer and contacts for remote alarm bell.

ix Controls:

- 1) Enclosure: NEMA 250, Type 1 wall mounted.
- 2) Switch Type: Mechanical-float type, in NEMA 250, Type 6 enclosures with mounting rod and electric cables.
- 3) Automatic Alternator: Start pumps on successive cycles and start multiple pumps if one cannot handle load.
- 4) High-Water Alarm: Rod-mounted, NEMA 250, Type 6 enclosure with mechanical-float, switch matching control and electric bell; 120 V ac, with transformer and contacts for remote alarm bell.

x Control-Interface Features:

- 1) Remote Alarm Contacts: For remote alarm interface.
- 2) Building Automation System Interface: Auxiliary contacts in pump controls for interface to building automation system and capable of providing the following:
 - On-off status of pump.
 - Alarm status.

B.7.4 Sump Pump Basin Cover

1. Basin Covers: Fabricate metal cover with openings having gaskets, seals, and bushings; for access to pumps, pump shafts, control rods, discharge piping, vent connections, and power cables.
 - a. Reinforcement: Steel or cast iron, capable of supporting foot traffic for basins installed in foot-traffic areas.
 - b. Characteristics
 - i Cover Material: Cast iron or steel with bituminous coating.

B.7.5 Sump Pump Motors

1. Comply with NEMA designation, temperature rating, service factor, enclosure type, and efficiency requirements for motors specified in Section "Common Motor Requirements for Plumbing Equipment."
 - a. Motor Sizes: Minimum size as indicated. If not indicated, large enough so driven load will not require motor to operate in service factor range above 1.0.
 - b. Motors for submersible pumps shall be hermetically sealed.

B.8 Electric Domestic Water Heaters

1. Refer to the Plumbing Equipment Schedule on the Contract drawings for additional information.

B.8.2 Performance Requirements

1. Electrical Components, Devices, and Accessories: Listed and labeled as defined in NFPA 70, by an NRTL, and marked for intended location and use.
2. ASHRAE/IES Compliance: Applicable requirements in ASHRAE/IES 90.1
 - a. ASME Compliance: Where ASME-code construction is indicated, fabricate and label commercial, domestic-water heater storage tanks to comply with ASME Boiler and Pressure Vessel Code: Section VIII, Division 1.
 - b. NSF Compliance: Fabricate and label equipment components that will be in contact with potable water to comply with NSF 61 and NSF 372.

B.8.3 Electric, Storage, Domestic Water Heaters

1. Manufacturers: Subject to compliance with requirements, provide products by one of the following:
 - a. Hubbell Water Heaters
 - b. Bradford White Corporation.
 - c. Lochinvar Corporation.
 - d. Rheem Manufacturing Company.
 - e. Smith, A. O. Water Products Co.; a division of A. O. Smith Corporation.
 - i Source Limitations: Obtain domestic-water heaters from single source from single manufacturer.
 - ii Standard: UL 1453.
 - iii Storage-Tank Construction: Non-ASME-code, steel.
 - 1) Tappings: Factory fabricated of materials compatible with tank and piping connections. Attach tappings to tank before testing.
 - NPS 2 and Smaller: Threaded ends according to ASME B1.20.1.
 - NPS 2-1/2 and Larger: Flanged ends according to ASME B16.5 for steel and stainless steel flanges, and according to ASME B16.24 for copper and copper-alloy flanges.
 - 2) Pressure Rating: 150 psig.
 - 3) Interior Finish: Comply with NSF 61 and NSF 372 barrier materials for potable-water tank linings, including extending lining material into tappings.
 - iv Factory-Installed, Storage-Tank Appurtenances:
 - 1) Anode Rod: Replaceable magnesium.
 - 2) Drain Valve: Corrosion-resistant metal with hose-end connection.
 - 3) Insulation: Comply with ASHRAE/IES 90.1.
 - 4) Jacket: Steel with enameled finish or high-impact composite material.
 - 5) Heating Elements: Electric, screw-in or bolt-on immersion type arranged in multiples of three.
 - 6) Temperature Control: Adjustable thermostat.
 - 7) Safety Controls: High-temperature-limit and low-water cutoff devices or systems.
 - 8) Relief Valves: ASME rated and stamped for combination temperature-and-pressure relief valves. Include one or more relief valves with total relieving capacity at least as great as heat input, and include pressure setting less than working-pressure rating of domestic-water heater. Select one relief valve with sensing element that extends into storage tank.
 - v Special Requirements: NSF 5 construction.

B.8.4 Domestic Water Heater Accessories

1. Domestic Water Expansion Tank:
 - a. Manufacturers: Subject to compliance with requirements, provide products by one of the following:
 - i Smith, A. O. Water Products Co.; a division of A. O. Smith Corporation.
 - ii AMTROL Inc.
 - iii Flexcon Industries.

- iv Honeywell International Inc.
 - v State Industries.
 - 1) Source Limitations: Obtain domestic-water heaters from single source from single manufacturer. Source Limitations: Obtain domestic-water expansion tanks from single source from single manufacturer.
 - 2) Description: Steel pressure-rated tank constructed with welded joints and factory-installed, butyl-rubber diaphragm. Include air precharge to minimum system-operating pressure at tank.
 - 3) Construction:
 - Tappings: Factory-fabricated steel, welded to tank before testing and labeling. Include ASME B1.20.1 pipe thread.
 - Interior Finish: Comply with NSF 61 and NSF 372 barrier materials for potable-water tank linings, including extending finish into and through tank fittings and outlets.
 - Air-Charging Valve: Factory installed.
2. Capacity and Characteristics:
- a. Working-Pressure Rating: 100 psig.
 - b. Capacity Acceptable: 2 gal. minimum.
 - i Drain Pans: Corrosion-resistant metal with raised edge. Include dimensions not less than base of domestic-water heater, and include drain outlet not less than NPS ¾ with ASME B1.20.1 pipe threads.
 - ii Piping-Type Heat Traps: Field-fabricated piping arrangement according to ASHRAE/IES 90.1.
 - iii Heat-Trap Fittings: ASHRAE/IES 90.1.
 - c. Manifold Kits: Domestic-water-heater manufacturer's factory-fabricated inlet and outlet piping for field installation, for multiple domestic-water heater installation. Include ball-, butterfly-, or gate-type shutoff valves to isolate each domestic-water heater and calibrated memory-stop balancing valves to provide balanced flow through each domestic-water heater.
 - d. Pressure-Reducing Valves: ASSE 1003 for water. Set at 25-psig- maximum outlet pressure unless otherwise indicated.
 - e. Combination Temperature-and-Pressure Relief Valves: ASME rated and stamped. Include relieving capacity at least as great as heat input, and include pressure setting less than working-pressure rating of domestic-water heater. Select relief valves with sensing element that extends into storage tank.
 - f. Pressure Relief Valves: ASME rated and stamped. Include pressure setting less than working-pressure rating of domestic-water heater.
 - g. Vacuum Relief Valves: ANSI Z21.22/CSA 4.4.
 - h. Shock Absorbers: ASSE 1010 or PDI-WH 201, Size A water hammer arrester.
 - i. Domestic-Water Heater Stands: Manufacturer's factory-fabricated steel stand for floor mounting, capable of supporting domestic-water heater and water. Include dimension that will support bottom of domestic-water heater a minimum of 18 inches above the floor.
 - j. Domestic-Water Heater Mounting Brackets: Manufacturer's factory-fabricated steel bracket for wall mounting, capable of supporting domestic-water heater and water.

B.8.5 Source Quality Control

1. Factory Tests: Test and inspect domestic-water heaters specified to be ASME-code construction, according to ASME Boiler and Pressure Vessel Code.
2. Hydrostatically test domestic-water heaters to minimum of one and one-half times pressure rating before shipment.
3. Electric, domestic-water heaters will be considered defective if they do not pass tests and inspections.
4. Prepare test and inspection reports.

B.9 Natural Gas Systems

B.9.1 Materials and Products

General: Provide piping materials and factory fabricated piping products of sizes, types, pressure ratings, and capacities as indicated. Where not indicated, provide proper selection as determined by Installer to comply with installation requirements. Provide materials and products complying with NFPA 54 where applicable, base pressure rating on natural gas piping system maximum design pressures. Provide sizes and types matching piping and equipment connections; provide fittings of materials that match pipe materials used in natural gas systems.

B.9.2 Basic Pipes and Pipe Fittings

Building Distribution Piping: Pipe Size 2 inches and Smaller:

1. Black steel pipe; Schedule 40, malleable iron threaded fittings.
2. 304 Stainless Steel Pipe; Schedule 40S, stainless steel threaded fittings.
3. Pipe Size 2½ inches and Larger: Black steel pipe: Schedule 40; wrought steel butt-welding fittings.

Gas Piping (Underground) – Underground piping from utility main to the Gas Meter shall be by the local gas utility. Piping from the meter into the Structure shall be considered building distribution piping.

B.9.3 Special Valves

General: Special valves required for natural gas systems include the following types:

1. Gas Cocks:
 - a. Gas Cocks 2 inches and Smaller: 150 psi non-shock WOG, bronze straightway cock, flat or square head, threaded ends.
 - b. Gas Cocks 2½ inches and Larger: 125 psi non-shock WOG, iron body bronze mounted, straightway cock, square head, flanged ends.
 - c. Pressure Regulators: Step down pressure regulator, lock-up type staging type, reduction and capacity as required.

Manufacturer: Subject to compliance with requirements, provide gas cocks of one of the following:

2. NIBCO, Inc.
3. DeZurik Corporation
4. Jenkins Bros.
5. Lunkenheimer Company
6. Rockwell International, Flow Control Division
7. Stockham Valves and Fittings
8. Walworth Company

B.9.4 Dielectric Fittings

1. General Requirements: Assembly of copper alloy and ferrous materials with separating nonconductive insulating material. Include end connections compatible with pipes to be joined.

2. Dielectric Unions:
 - a. Standard: ASSE 1079.
 - b. Pressure Rating: 125 psig minimum at 180 deg F.
 - c. End Connections: Solder-joint copper alloy and threaded ferrous.
 - d. Manufacturer: Subject to compliance with requirements, provide gas cocks of one of the following:
 - i Capitol Manufacturing Company.
 - ii Central Plastics Company.
 - iii Hart Industries International, Inc.
 - iv Jomar International Ltd.
 - 1) Matco-Norca, Inc.
 - 2) McDonald, A. Y. Mfg. Co.
 - 3) Watts Regulator Co.; a division of Watts Water Technologies, Inc.
 - 4) Wilkins; a Zurn company.
3. Dielectric Flanges:
 - a. Standard: ASSE 1079.
 - i Factory-fabricated, bolted, companion-flange assembly.
 - ii Pressure Rating: 125 psig minimum at 180 deg F.
 - iii End Connections: Solder-joint copper alloy and threaded ferrous; threaded solder-joint copper alloy and threaded ferrous.
 - iv Manufacturer: Subject to compliance with requirements, provide gas cocks of one of the following:
 - b. Capitol Manufacturing Company.
 - c. Central Plastics Company.
 - d. Matco-Norca, Inc.
 - e. Watts Regulator Co.; a division of Watts Water Technologies, Inc.
 - f. Wilkins; a Zurn company

B.10 Hangers and Supports

B.10.1 Performance Requirements

1. Structural Performance: Hangers and supports for plumbing piping and equipment shall withstand the effects of gravity loads and stresses within limits and under conditions indicated according to ASCE/SEI 7.
 - a. Design supports for multiple pipes, including pipe stands, capable of supporting combined weight of supported systems, system contents, and test water.
 - b. Design equipment supports capable of supporting combined operating weight of supported equipment and connected systems and components.
 - c. Design seismic-restraint hangers and supports for piping and equipment and obtain approval from authorities having jurisdiction.

B.10.2 Metal Pipe Hangers and Supports

1. Carbon-Steel Pipe Hangers and Supports:
 - a. Description: MSS SP-58, Types 1 through 58, factory-fabricated components.
 - b. Galvanized Metallic Coatings: Pre-galvanized, hot-dip galvanized, or electro-galvanized.

- c. Nonmetallic Coatings: Plastic coated or epoxy powder coated.
 - d. Padded Hangers: Hanger with fiberglass or other pipe insulation pad or cushion to support bearing surface of piping.
 - e. Hanger Rods: Continuous-thread rod, nuts, and washer made of stainless steel.
2. Stainless-Steel Pipe Hangers and Supports:
 - a. Description: MSS SP-58, Types 1 through 58, factory-fabricated components.
 - b. Padded Hangers: Hanger with fiberglass or other pipe insulation pad or cushion to support bearing surface of piping.
 - c. Hanger Rods: Continuous-thread rod, nuts, and washer made of stainless steel.
 3. Copper Pipe and Tube Hangers:
 - a. Description: MSS SP-58, Types 1 through 58, copper-coated-steel, factory-fabricated components.
 - b. Hanger Rods: Continuous-thread rod, nuts, and washer made of copper-coated steel stainless steel.

B.10.3 Trapeze Pipe Hangers

- B.10.3.1** Description: MSS SP-58, Type 59, shop- or field-fabricated pipe-support assembly, made from structural-carbon-steel shapes, with MSS SP-58 carbon-steel hanger rods, nuts, saddles, and U-bolts.

B.10.4 Metal Framing Systems

1. MFMA Manufacturer Metal Framing Systems:
 - a. Manufacturers: Subject to compliance with requirements, provide products by one of the following:
 - i Cooper B-Line, Inc.
 - ii Flex-Strut Inc.
 - iii Thomas & Betts Corporation.
 - iv Unistrut Corporation; Tyco International, Ltd.
 - 1) Description: Shop- or field-fabricated pipe-support assembly, made of steel channels, accessories, fittings, and other components for supporting multiple parallel pipes.
 - 2) Standard: Comply with MFMA-4, factory-fabricated components for field assembly.
 - 3) Channels: Continuous slotted **stainless-steel, Type 316** channel with inturned lips.
 - 4) Channel Width: Selected for applicable load criteria.
 - 5) Channel Nuts: Formed or stamped nuts or other devices designed to fit into channel slot and, when tightened, prevent slipping along channel.
 - 6) Hanger Rods: Continuous-thread rod, nuts, and washer made of **stainless steel**.
 - 7) Metallic Coating: Plain

B.10.5 Thermal Hanger Shield Inserts

1. Manufacturers: Subject to compliance with requirements, provide products by one of the following:
 - a. Carpenter & Paterson, Inc.
 - b. National Pipe Hanger Corporation.

- c. Pipe Shields, Inc.; a subsidiary of Piping Technology & Products, Inc.
- d. Rilco Manufacturing Co., Inc.
 - i. Insulation-Insert Material for Cold Piping: ASTM C552, Type II cellular glass with 100-psig or ASTM C591, Type VI, Grade 1 polyisocyanurate with 125-psig minimum compressive strength and vapor barrier.
 - ii. Insulation-Insert Material for Hot Piping: ASTM C552, Type II cellular glass with 100-psig or ASTM C591, Type VI, Grade 1 polyisocyanurate with 125-psig minimum compressive strength.
 - iii. For Trapeze or Clamped Systems: Insert and shield shall cover entire circumference of pipe.
 - iv. For Clevis or Band Hangers: Insert and shield shall cover lower 180 degrees of pipe.
 - v. Insert Length: Extend 2 inches beyond sheet metal shield for piping operating below ambient air temperature.

B.10.6 Pipe Stands

1. General Requirements for Pipe Stands: Shop- or field-fabricated assemblies made of manufactured corrosion-resistant components to support roof-mounted piping.
 - a. Compact Pipe Stand:
 - i. Description: Single base unit with integral-rod roller, pipe clamps, or V-shaped cradle to support pipe, for roof installation without membrane penetration.
 - ii. Base: Single, vulcanized rubber, molded polypropylene, or polycarbonate.
 - iii. Hardware: Galvanized steel or polycarbonate.
 - iv. Accessories: Protection pads.
 - v. Vertical Members: Two stainless-steel, continuous-thread, 1/2-inch rods.
 - vi. Horizontal Member: Adjustable horizontal, stainless steel pipe support channels.
 - vii. Pipe Supports: Roller.
 - viii. Hardware: Stainless steel.
 - ix. Accessories: Protection pads.
 - x. Height: 12 inches above roof.

B.10.7 Fastener Systems

1. Powder-Actuated Fasteners: Threaded-steel stud, for use in hardened portland cement concrete, with pull-out, tension, and shear capacities appropriate for supported loads and building materials where used.
 - a. Manufacturers: Subject to compliance with requirements, provide products by one of the following:
 - i. Hilti, Inc.
 - ii. ITW Ramset/Red Hat
 - iii. MKT Fastening, LLC.
 - iv. Simpson Strong Tie Co.

2. Mechanical-Expansion Anchors: Insert-wedge-type anchors, for use in hardened portland cement concrete, with pull-out, tension, and shear capacities appropriate for supported loads and building materials where used.
 - a. Manufacturers: Subject to compliance with requirements, provide products by one of the following:
 - i B-Line; Eaton
 - ii Hilti, Inc.
 - iii ITW Ramset/Red Hat
 - iv MKT Fastening, LLC.
 - b. Indoor Applications: Zinc-coated or stainless steel.
 - c. Outdoor Applications: Stainless steel.

B.10.8 Pipe Positioning Systems

1. Description: IAPMO PS 42 positioning system composed of metal brackets, clips, and straps for positioning piping in pipe spaces; for plumbing fixtures in commercial applications.

B.10.9 Equipment Support

1. Description: Welded, shop- or field-fabricated equipment support made from structural-carbon-steel shapes.

B.10.10 Materials

1. Aluminum: ASTM B221.
 - a. Carbon Steel: ASTM A1011/A1011M.
 - b. Structural Steel: ASTM A36/A36M carbon-steel plates, shapes, and bars; black and galvanized.
 - c. Stainless Steel: ASTM A240/A240M.
 - d. Grout: ASTM C1107/C1107M, factory-mixed and -packaged, dry, hydraulic-cement, non-shrink and nonmetallic grout; suitable for interior and exterior applications.
 - i Properties: Non-staining, noncorrosive, and nongaseous.
 - ii Design Mix: 5000-psi, 28-day compressive strength.

B.11 Plumbing Valves

B.11.1 General requirements

1. Source Limitations for Valves: Obtain each type of valve from single source from single manufacturer.
 - a. ASME Compliance:
 - i ASME B1.20.1 for threads for threaded end valves.
 - ii ASME B16.10 and ASME B16.34 for ferrous valve dimensions and design criteria.
 - iii ASME B16.18 for solder-joint connections
 - iv ASME B31.9 for building services piping valves.
2. NSF Compliance: NSF 61 and NSF 372 for valve materials for potable-water service.
3. Bronze valves shall be made with dezincification-resistant materials. Bronze valves made with copper alloy (brass) containing more than 15 percent zinc are not permitted.
4. Valve Pressure-Temperature Ratings: Not less than indicated and as required for system pressures and temperatures.
 - a. Valve Sizes: Same as upstream piping unless otherwise indicated.

- b. Valves in Insulated Piping:
 - i Include 2-inch stem extensions.
 - ii Extended operating handles of nonthermal-conductive material and protective sleeves that allow operation of valves without breaking vapor seals or disturbing insulation.
 - iii Memory stops that are fully adjustable after insulation is applied.

B.11.2 Brass Ball Valves

1. Brass Ball Valves, Two-Piece with Full Port and Stainless-Steel Trim, Threaded or Soldered Ends:

- a. Acceptable Manufacturers:
 - i Crane Valves.
 - ii Jenkins Valves.
 - iii Milwaukee Valve Company.
 - iv Conbraco Industries, Inc.; Apollo Valves.
 - v Nibco
- b. Description:
 - i Standard: MSS SP-110 or MSS SP-145.
 - ii CWP Rating: 600 psig.
 - iii Body Design: Two piece.
 - iv Body Material: Forged brass.
 - v Ends: Threaded and soldered.
 - vi Seats: PTFE.
 - vii Stem: Stainless steel.
 - viii Ball: Stainless steel, vented.
 - ix Port: Full.

B.11.3 Bronze Ball Valves

1. Bronze Ball Valves, Two-Piece with Full Port and Stainless-Steel Trim:

- a. Acceptable Manufacturers:
 - i Crane Valves.
 - ii Milwaukee Valve Company.
 - iii Conbraco Industries, Inc.; Apollo Valves.
 - iv Nibco
 - v Hammond Valve
 - vi Watts Water Technologies
- b. Description:
 - i Standard: MSS SP-110 or MSS-145.
 - ii CWP Rating: 600 psig
 - iii Body Design: Two piece.
 - iv Body Material: Bronze.
 - v Ends: Threaded or soldered.
 - vi Seats: PTFE.

- vii Stem: Stainless steel.
- viii Ball: Stainless steel, vented.
- ix Port: Full.

B.11.4 Bronze Gate Valves

1. Bronze Gate Valves, NRS, Class 125:

- a. Acceptable Manufacturers:
 - i Apollo Flow Controls, Conbraco.
 - ii Crane
 - iii Hammond
 - iv Jenkins Valves
 - v Milwaukee
 - vi Nibco, Inc.
 - vii Stockham
- b. Description:
 - i Standard: MSS SP-80, Type 1.
 - ii CWP Rating: 200 psig.
 - iii Body Material: Bronze with integral seat and screw-in bonnet.
 - iv Ends: Threaded or solder joint.
 - v Stem: Bronze.
 - vi Disc: Solid wedge; bronze.
 - vii Packing: Asbestos free.
 - viii Handwheel: Malleable iron, bronze, or aluminum.

B.11.5 Iron Gate Valves

1. Iron Gate Valves, NRS, Class 150:

- a. Acceptable Manufacturers:
 - i Apollo Flow Controls, Conbraco.
 - ii Crane
 - iii Hammond
 - iv Jenkins Valves
 - v Milwaukee
 - vi Nibco, Inc.
 - vii Stockham
- b. Description:
 - i Standard: MSS SP-70, Type I.
 - ii CWP Rating: 200 psig.
 - iii Body Material: Gray iron with bolted bonnet.
 - iv Ends: Flanged.
 - v Trim: Bronze.

- vi Disc: Solid wedge.
- vii Packing and Gasket: Asbestos free.

B.11.6 Bronze Ceck Valves

1. Bronze Swing Check Valves with Bronze Disc, Class 125:
 - a. Acceptable Manufacturers:
 - i Apollo Flow Controls, Conbraco.
 - ii Crane
 - iii Hammond
 - iv Jenkins Valves
 - v Milwaukee
 - vi Nibco, Inc.
 - vii Stockham
 - b. Description:
 - i Standard: MSS SP-80, Type 3.
 - ii CWP Rating: 200 psig
 - iii Body Design: Horizontal flow.
 - iv Body Material: ASTM B62, bronze.
 - v Ends: Threaded or soldered. See valve schedule articles.
 - vi Disc: Bronze.
2. Bronze Swing Check Valves with Nonmetallic Disc, Class 150:
 - a. Acceptable Manufacturers:
 - i Crane
 - ii Hammond
 - iii Jenkins Valves
 - iv Milwaukee
 - v Nibco, Inc.
 - b. Description:
 - i Standard: MSS SP-80, Type 4.
 - ii CWP Rating: 300 psig.
 - iii Body Design: Horizontal flow.
 - iv Body Material: ASTM B62, bronze.
 - v Ends: Threaded or soldered. See valve schedule articles.
 - vi Disc: PTFE.

B.11.7 Iron Swing Check Valves

1. Iron Swing Check Valves with Metal Seats, Class 125:
 - a. Acceptable Manufacturers:
 - i Apollo Flow Controls, Conbraco.
 - ii Crane
 - iii Hammond

- iv Jenkins Valves
 - v Milwaukee
 - vi Nibco, Inc.
- b. Description:
- i Standard: MSS SP-71, Type I.
 - ii CWP Rating: 200 psig
 - iii Body Design: Clear or full waterway.
 - iv Body Material: ASTM A126, gray iron with bolted bonnet.
 - v Ends: Flanged or threaded. See valve schedule articles.
 - vi Trim: Bronze.
 - vii Gasket: Asbestos free.
2. Iron Swing Check Valves with Nonmetallic-to-Metal Seats, Class 125:
- a. Acceptable Manufacturers:
- i Crane
 - ii Stockham
- b. Description:
- i Standard: MSS SP-71, Type I.
 - ii CWP Rating: 200 psig
 - iii Body Design: Clear or full waterway.
 - iv Body Material: ASTM A126, gray iron with bolted bonnet.
 - v Ends: Flanged or threaded. See valve schedule articles.
 - vi Trim: Composition.
 - vii Seat Ring: Bronze.
 - viii Disc Holder: Bronze.

B.11.8 Iron Grooved-end Swing Check Valves

1. Iron, Grooved-End Swing Check Valves, 300 CWP:
- a. Acceptable Manufacturers:
- i Anvil International
 - ii Shurjoint – Apollo
 - iii Victaulic Co.
- b. Description:
- i CWP Rating: 300 psig.
 - ii Body Material: ASTM A536, ductile iron.
 - iii Seal: EPDM.
 - iv Disc: Spring operated, ductile iron or stainless steel.

B.12 Escutcheons For Plumbing Piping

B.12.1 Manufacturers

1. Manufacturers: Subject to compliance with requirements, provide products by one of the following:
 - a. BrassCraft Manufacturing
 - b. Dearborn Brass
 - c. Keeney Manufacturing Company
 - d. Mid-Atlantoc Fittings, Inc.
 - e. ProFlo; a Ferguson Enterprise

B.12.2 Escutcheons

1. One-Piece, Steel Type: With polished, chrome-plated finish and setscrew fastener.
 - a. One-Piece, Cast-Brass Type: With polished, chrome-plated finish and setscrew fastener.
2. One-Piece, Deep-Pattern Type: Deep-drawn, box-shaped steel with polished, chrome-plated finish and spring-clip fasteners.
3. One-Piece, Stamped-Steel Type: With polished, chrome-plated finish and spring-clip fasteners.
4. Split-Plate, Stamped-Steel Type: With polished, chrome-plated finish; concealed and exposed-rivet hinge; and spring-clip fasteners.

B.12.3 Floor Plates

1. Split Floor Plates: Cast brass with concealed hinge.

B.13 Identification for Plumbing Piping and Equipment

B.13.1 Equipment Labels

1. Metal Labels for Equipment:
 - a. Manufacturers: Subject to compliance with requirements, provide products by one of the following:
 - i Brady Corporation
 - ii Craftmark Pipe Markers
 - iii Seton Identification Products
 - b. Material and Thickness: aluminum, 0.032-inch or anodized aluminum, 0.032-inch minimum thickness, and having predrilled or stamped holes for attachment hardware.
 - i Letter Color: White.
 - ii Background Color: Black.
 - iii Minimum Label Size: Length and width vary for required label content, but not less than 2-1/2 by 3/4 inch.
 - iv Minimum Letter Size: 1/4 inch for name of units if viewing distance is less than 24 inches, 1/2 inch for viewing distances up to 72 inches, and proportionately larger lettering for greater viewing distances. Include secondary lettering two-thirds to three-quarters the size of principal lettering.
 - v Fasteners: Stainless-steel rivets or self-tapping screws.
 - vi Adhesive: Contact-type permanent adhesive, compatible with label and with substrate.

- c. Plastic Labels for Equipment:
 - i Manufacturers: Subject to compliance with requirements, provide products by one of the following:
 - 1) Brady Corporation
 - 2) Craftmark Pipe Markers
 - 3) Seton Identification Products
 - ii Material and Thickness: Multilayer, multicolor, plastic labels for mechanical engraving, 1/8 inch thick, and having predrilled holes for attachment hardware.
 - iii Letter Color: White.
 - iv Background Color: Black.
 - v Maximum Temperature: Able to withstand temperatures up to 160 deg F.
 - vi Minimum Label Size: Length and width vary for required label content, but not less than 2-1/2 by 3/4 inch.
 - vii Minimum Letter Size: 1/4 inch for name of units if viewing distance is less than 24 inches, 1/2 inch for viewing distances up to 72 inches, and proportionately larger lettering for greater viewing distances. Include secondary lettering two-thirds to three-quarters the size of principal lettering.
 - viii Fasteners: Stainless-steel rivets or self-tapping screws.
 - ix Adhesive: Contact-type permanent adhesive, compatible with label and with substrate.
- d. Label Content: Include equipment's Drawing designation or unique equipment number, Drawing numbers where equipment is indicated (plans, details, and schedules), and the Specification Section number and title where equipment is specified.
- e. Equipment Label Schedule: For each item of equipment to be labeled, on 8-1/2-by-11-inch bond paper. Tabulate equipment identification number and identify Drawing numbers where equipment is indicated (plans, details, and schedules) and the Specification Section number and title where equipment is specified. Equipment schedule shall be included in operation and maintenance data.

B.13.2 Warning Signs and Labels

- 1. Manufacturers: Subject to compliance with requirements, provide products by one of the following:
 - a. Brady Corporation
 - b. Craftmark Pipe Markers
 - c. Seton Identification Products
- 2. Material and Thickness: Multilayer, multicolor, plastic labels for mechanical engraving, 1/8 inch thick, and having predrilled holes for attachment hardware.
 - a. Letter Color: White.
 - b. Background Color: Red.
 - c. Maximum Temperature: Able to withstand temperatures up to 160 deg F.
 - d. Minimum Label Size: Length and width vary for required label content, but not less than 2-1/2 by 3/4 inch.
 - e. Minimum Letter Size: 1/4 inch for name of units if viewing distance is less than 24 inches, 1/2 inch for viewing distances up to 72 inches, and proportionately larger lettering for greater viewing distances. Include secondary lettering two-thirds to three-quarters the size of principal lettering.

- f. Fasteners: Stainless-steel rivets or self-tapping screws.
 - i. Adhesive: Contact-type permanent adhesive, compatible with label and with substrate.
- 3. Label Content: Include caution and warning information plus emergency notification instructions.

B.13.3 Pipe Labels

1. Manufacturers: Subject to compliance with requirements, provide products by one of the following:
 - a. Brady Corporation
 - b. Craftmark Pipe Markers
 - c. Seton Identification Products
2. General Requirements for Manufactured Pipe Labels: Preprinted, color-coded, with lettering indicating service, and showing flow direction.
3. Pretensioned Pipe Labels: Pre-coiled, semirigid plastic formed to cover full circumference of pipe and to attach to pipe without fasteners or adhesive.
4. Self-Adhesive Pipe Labels: Printed plastic with contact-type, permanent-adhesive backing.
5. Pipe Label Contents: Include identification of piping service using same designations or abbreviations as used on Drawings; also include pipe size and an arrow indicating flow direction.
 - a. Flow-Direction Arrows: Integral with piping-system service lettering to accommodate both directions or as separate unit on each pipe label to indicate flow direction.
 - b. Lettering Size: Size letters according to ASME A13.1 for piping.

B.13.4 Valve Tags

1. Manufacturers: Subject to compliance with requirements, provide products by one of the following:
 - a. Brady Corporation
 - b. Craftmark Pipe Markers
 - c. Seton Identification Products
 - i. Valve Tags: Stamped or engraved with 1/4-inch letters for piping system abbreviation and 1/2-inch numbers.
 - 1) Tag Material: Brass, 0.032-inch minimum thickness, and having predrilled or stamped holes for attachment hardware.
 - 2) Fasteners: Brass beaded chain or S-hook.
 - 3) Plastic tie-wraps are not acceptable as a means of securement.
 - d. Valve Schedules: For each piping system, on 8-1/2-by-11-inch bond paper. Tabulate valve number, piping system, system abbreviation (as shown on valve tag), location of valve (room or space), normal-operating position (open, closed, or modulating), and variations for identification. Mark valves for emergency shutoff and similar special uses.
 - i. Valve-tag schedule shall be included in operation and maintenance data.

B.13.5 Warning Tags

1. Manufacturers: Subject to compliance with requirements, provide products by one of the following:
 - a. Brady Corporation
 - b. Craftmark Pipe Markers
 - c. Seton Identification Products

2. Description: Preprinted or partially preprinted accident-prevention tags of plasticized card stock with matte finish suitable for writing.
 - a. Size: Approximately 4 by 7 inches.
 - b. Fasteners: Brass grommet and wire
 - c. Nomenclature: Large-size primary caption such as "DANGER," "CAUTION," or "DO NOT OPERATE."
 - d. Color: Safety yellow background with black lettering.

B.14 Plumbing Fixtures

B.14.1 Service Sinks

1. Service Sinks: Enameled, cast iron, trap standard mounted.
 - a. Fixture:
 - i Standard: ASME A112.19.1/CSA B45.2.
 - ii Type: Service sink with back.
 - iii Back: Two faucet holes.
 - iv Nominal Size: 22 by 18 inches
 - v Color: White.
 - vi Mounting: NPS 2 P-trap standard with grid strainer inlet, cleanout, and floor flange.
 - vii Rim Guard: On front and sides.
 - b. Faucet: Sink Faucets.
 - c. Support: Type II sink carrier.
 - d. Waste Fittings:
 - i Standard: ASME A112.18.2/CSA B125.2.
 - ii Trap(s):
 - 1) Size: NPS 2.
 - 2) Material: two-piece, cast-brass trap and swivel elbow with 0.032-inch- thick brass tube to wall; and chrome-plated brass or steel wall flange.

C Construction

C.1 Domestic Water Piping

1. Install piping indicated to be exposed and piping in equipment rooms and service areas at right angles or parallel to building walls. Diagonal runs are prohibited unless specifically indicated otherwise.
2. Install piping free of sags and bends.
3. Install piping to allow application of insulation.
4. Install fittings for changes in direction and branch connections.
5. Install piping to permit valve servicing.
6. Install thermometers on outlet piping from each water heater
7. Install escutcheons for piping penetrations of walls, ceilings, and floors
8. Select system components with pressure rating equal to or greater than system operating pressure.
9. Sleeves are required for core-drilled holes.

10. Install sleeves for pipes passing through concrete and masonry walls, gypsum-board partitions, and concrete floor and roof slabs.
11. Cut sleeves to length for mounting flush with both surfaces.
 - a. Exception: Extend sleeves installed in floors of mechanical equipment areas or other wet areas 2 inches above finished floor level. Extend cast-iron sleeve fittings below floor slab as required to secure clamping ring if ring is specified.
12. Install sleeves in new walls and slabs as new walls and slabs are constructed.
13. Install sleeves that are large enough to provide 1/4-inch annular clear space between sleeve and pipe or pipe insulation. Use the following sleeve materials:
14. Steel Pipe Sleeves: For pipes smaller than NPS 6.
 - a. Verify final equipment locations for roughing-in.

C.1.2 Piping Joint Construction

1. Join pipe and fittings according to the following requirements.
2. Ream ends of pipes and tubes and remove burrs. Bevel plain ends of steel pipe.
3. Remove scale, slag, dirt, and debris from inside and outside of pipe and fittings before assembly.
4. Soldered Joints: Apply ASTM B 813, water-flushable flux, unless otherwise indicated, to tube end. Construct joints according to ASTM B 828 or CDA's "Copper Tube Handbook," using lead-free solder alloy complying with ASTM B 32.
5. Brazed Joints: Construct joints according to AWS's "Brazing Handbook," "Pipe and Tube" Chapter, using copper-phosphorus brazing filler metal complying with AWS A5.8.

C.1.3 Equipment Installation – Common Requirements.

1. Install equipment to allow maximum possible headroom unless specific mounting heights are indicated.
2. Install equipment level and plumb, parallel and perpendicular to other building systems and components in exposed interior spaces, unless otherwise indicated.
3. Install equipment to facilitate service, maintenance, and repair or replacement of components. Connect equipment for ease of disconnecting, with minimum interference to other installations. Extend grease fittings to accessible locations.
4. Install equipment to allow right-of-way for piping installed at required slope.

C.1.4 Field Quality Control

1. Perform the following tests and inspections:
 - a. Piping Inspections:
 - i Do not enclose, cover, or put piping into operation until it has been inspected and approved
 - ii by authorities having jurisdiction.
 - iii During installation, notify authorities having jurisdiction at least one day before inspection
 - iv must be made. Perform tests specified below in presence of authorities having jurisdiction:
 - 1) Roughing-in Inspection: Arrange for inspection of piping before concealing or closing in after roughing in and before setting fixtures.
 - 2) Final Inspection: Arrange for authorities having jurisdiction to observe tests specified in "Piping Tests" Subparagraph below and to ensure compliance with requirements.
 - v Reinspection: If authorities having jurisdiction find that piping will not pass tests or

- vi inspections, make required corrections and arrange for reinspection.
 - vii Reports: Prepare inspection reports and have them signed by authorities having
 - viii jurisdiction.
2. Piping Tests:
- i Fill domestic water piping. Check components to determine that they are not air bound and that piping is full of water.
 - ii Test for leaks and defects in new piping and parts of existing piping that have been altered, extended, or repaired. If testing is performed in segments, submit a separate report for each test, complete with diagram of portion of piping tested.
 - iii Leave new, altered, extended, or replaced domestic water piping uncovered and unconcealed until it has been tested and approved. Expose work that was covered or concealed before it was tested.
 - iv Cap and subject piping to static water pressure of 50 psig above operating pressure, without exceeding pressure rating of piping system materials. Isolate test source and allow it to stand for four hours. Leaks and loss in test pressure constitute defects that must be repaired.
 - v Repair leaks and defects with new materials, and retest piping or portion thereof until satisfactory results are obtained.
 - vi Prepare reports for tests and for corrective action required.
 - 1) Domestic water piping will be considered defective if it does not pass tests and inspections.
 - 2) Prepare test and inspection reports.

C.1.5 Cleaning

1. Clean and disinfect potable domestic water piping as follows:
 - a. Purge new piping and parts of existing piping that have been altered, extended, or repaired before using.
 - b. Use purging and disinfecting procedures prescribed by authorities having jurisdiction; if methods are not prescribed, use procedures described in either AWWA C651 or AWWA C652 or follow procedures described below:
 - c. Flush piping system with clean, potable water until dirty water does not appear at outlets.
 - d. Fill and isolate system according to either of the following:
 - e. Fill system or part thereof with water/chlorine solution with at least 50 ppm of
 - f. chlorine. Isolate with valves and allow to stand for 24 hours.
 - g. Fill system or part thereof with water/chlorine solution with at least 200 ppm of
 - h. chlorine. Isolate and allow to stand for three hours.
 - i. Flush system with clean, potable water until no chlorine is in water coming from system after the standing time.
 - i Repeat procedures if biological examination shows contamination.
2. Submit water samples in sterile bottles to authorities having jurisdiction.

C.2 Domestic Water Piping Specialties

Domestic water piping specialties will be considered defective if they do not pass tests and inspections.

C.3 Sanitary Waste and Vent Piping

1. Piping Installation
 - a. Install piping in concealed locations unless otherwise indicated and except in equipment rooms and service areas.
 - b. Install piping indicated to be exposed and piping in equipment rooms and service areas at right angles or parallel to building walls. Diagonal runs are prohibited unless specifically indicated otherwise.
 - c. Install piping above accessible ceilings to allow sufficient space for ceiling panel removal.
 - d. Install piping at indicated slopes.
 - e. Install fittings for changes in direction and branch connections.
 - f. Make changes in direction for soil and waste drainage and vent piping using appropriate branches, bends, and long-sweep bends.
 - i. Sanitary tees and short-sweep 1/4 bends may be used on vertical stacks if change in direction of flow is from horizontal to vertical.
 - ii. Use long-turn, double Y-branch and 1/8-bend fittings if two fixtures are installed back-to-back or side by side with common drainpipe.
 - 1) Straight tees, elbows, and crosses may be used on vent lines.
 - iii. Do not change direction of flow more than 90 degrees.
 - iv. Use proper size of standard increasers and reducers if pipes of different sizes are connected.
 - 1) Reducing size of waste piping in direction of flow is prohibited.
 - g. Lay buried building waste piping beginning at low point of each system.
 - i. Install true to grades and alignment indicated, with unbroken continuity of invert. Place hub ends of piping upstream.
 - ii. Install required gaskets according to manufacturer's written instructions for use of lubricants, cements, and other installation requirements.
 - iii. Maintain swab in piping and pull past each joint as completed.
 - h. Install soil and waste and vent piping at the following minimum slopes unless otherwise indicated:
 - i. Building Sanitary Drain: Slope downward in direction of flow for piping as required by code and per authority having jurisdiction.
 - ii. Sanitary Waste: 2 percent downward in direction of flow for piping NPS 3 and smaller; 1 percent downward in direction of flow for piping NPS 4 and larger.
 - iii. Vent Piping: 1 percent down toward vertical fixture vent or toward vent stack.
 - i. Install cast-iron soil piping according to CISPI's "Cast Iron Soil Pipe and Fittings Handbook," Chapter IV, "Installation of Cast Iron Soil Pipe and Fittings."
 - j. Install force mains at elevations indicated.
2. Plumbing Specialties:
 - a. Install cleanouts at grade and extend to where building sanitary drains connect to building sanitary sewers in sanitary waste gravity-flow piping.
 - b. Install cleanout fitting with closure plug inside the building in sanitary drainage force-main piping.
 - i. Do not enclose, cover, or put piping into operation until it is inspected and approved by authorities having jurisdiction.

- ii Install sleeves for piping penetrations of walls, ceilings, and floors.
 - iii Install sleeve seals for piping penetrations of concrete walls and slabs.
 - iv Install escutcheons for piping penetrations of walls, ceilings, and floors.
3. Joint Construction
- a. Join hub-and-spigot, cast-iron soil piping with according to CISPI's "Cast Iron Soil Pipe and Fittings Handbook"
 - b. Join hubless, cast-iron soil piping according to CISPI 310 and CISPI's "Cast Iron Soil Pipe and Fittings Handbook" for hubless-piping coupling joints.
 - c. Threaded Joints: Thread pipe with tapered pipe threads according to ASME B1.20.1.
 - i Cut threads full and clean using sharp dies.
 - ii Ream threaded pipe ends to remove burrs and restore full ID. Join pipe fittings and valves as follows:
 - d. Apply appropriate tape or thread compound to external pipe threads unless dry seal threading is specified.
 - e. Damaged Threads: Do not use pipe or pipe fittings with threads that are corroded or damaged.
 - f. Do not use pipe sections that have cracked or open welds.
 - g. Grooved Joints: Cut groove ends of pipe according to AWWA C606. Lubricate and install gasket over ends of pipes or pipe and fitting. Install coupling housing sections, over gasket, with keys seated in piping grooves. Install and tighten housing bolts.
 - h. Flanged Joints: Align bolt holes. Select appropriate gasket material, size, type, and thickness. Install gasket concentrically positioned. Use suitable lubricants on bolt threads. Torque bolts in cross pattern.
4. Specialty Pipe and Fittings
- a. Transition Couplings:
 - i Install transition couplings at joints of piping with small differences in ODs.
 - ii In Waste Drainage Piping: Shielded, nonpressure transition couplings.
 - iii In Aboveground Force Main Piping: Fitting-type transition couplings.
 - iv In Underground Force Main Piping:
 - b. NPS 1-1/2 and Smaller: Fitting-type transition couplings.
 - c. NPS 2 and Larger: Pressure transition couplings.
5. Dielectric Fittings:
- a. Install dielectric fittings in piping at connections of dissimilar metal piping and tubing.
 - b. Dielectric Fittings for NPS 2 and Smaller: Use dielectric unions.
 - c. Dielectric Fittings for NPS 2-1/2 to NPS 4 Use dielectric flanges or flange kits.

C.4 Sanitary Waste Piping Specialties

1. Installation
- a. Install cleanouts in aboveground piping and building drain piping according to the following, unless otherwise indicated:
 - i Size same as drainage piping
 - ii Locate at each change in direction of piping greater than 45 degrees.

- iii Locate at minimum intervals of 50 feet for piping NPS 4 and smaller and 100 feet for larger piping.
- iv Locate at base of each vertical soil and waste stack.
- b. For floor cleanouts for piping below floors, install cleanout deck plates with top flush with finished floor.
- c. For cleanouts located in concealed piping, install cleanout wall access covers, of types indicated, with frame and cover flush with finished wall.
- d. Install roof flashing assemblies on sanitary stack vents and vent stacks that extend through roof. Comply with requirements in Section "Sheet Metal Flashing and Trim."
- e. Install flashing fittings on sanitary stack vents and vent stacks that extend through roof. Comply with requirements in Section "Sheet Metal Flashing and Trim."
- f. Assemble open drain fittings and install with top of hub 2 inches above floor.
- g. Install deep-seal traps on floor drains and other waste outlets, if indicated.
- h. Install air-gap fittings on indirect-waste piping discharge into sanitary drainage system.
- i. Install sleeve and sleeve seals with each riser and stack passing through floors with waterproof membrane.
- j. Install expansion joints on vertical stacks and conductors. Position expansion joints for easy access and maintenance.
- k. Install wood-blocking reinforcement for wall-mounting-type specialties.

2. Flashing Installation

- a. Fabricate flashing from single piece unless large pans, sumps, or other drainage shapes are required.
- b. Install sheet flashing on pipes, sleeves, and specialties passing through or embedded in floors and roofs with waterproof membrane.
- c. Pipe Flashing: Sleeve type, matching pipe size, with minimum length of 10 inches, and skirt or flange extending at least 8 inches around pipe.
- d. Sleeve Flashing: Flat sheet, with skirt or flange extending at least 8 inches around sleeve.
- e. Embedded Specialty Flashing: Flat sheet, with skirt or flange extending at least 8 inches around specialty.
- f. Set flashing on floors and roofs in solid coating of bituminous cement.
- g. Secure flashing into sleeve and specialty clamping ring or device.
- h. Install flashing for piping passing through roofs with counterflashing or commercially made flashing fittings.
- i. Extend flashing up vent pipe passing through roofs and turn down into pipe, or secure flashing into cast-iron sleeve having calking recess.

C.5 Storm Drainage Piping

1. Piping Installation

- a. Install piping in concealed locations unless otherwise indicated and except in equipment rooms and service areas.
- b. Install piping indicated to be exposed and piping in equipment rooms and service areas at right angles or parallel to building walls. Diagonal runs are prohibited unless specifically indicated otherwise.
- c. Install piping above accessible ceilings to allow sufficient space for ceiling panel removal.
- d. Install piping at indicated slopes.

- e. Install fittings for changes in direction and branch connections.
 - f. Make changes in direction for piping using appropriate branches, bends, and long-sweep bends.
 - i. Do not change direction of flow more than 90 degrees.
 - ii. Use proper size of standard increasers and reducers if pipes of different sizes are connected.
 - iii. Reducing size of waste piping in direction of flow is prohibited.
 - g. Lay buried building storm drainage piping beginning at low point of each system.
 - i. Install true to grades and alignment indicated, with unbroken continuity of invert. Place hub ends of piping upstream.
 - ii. Install required gaskets according to manufacturer's written instructions for use of lubricants, cements, and other installation requirements.
 - iii. Maintain swab in piping and pull past each joint as completed.
 - h. Install piping at the following minimum slopes unless otherwise indicated:
 - i. 2 percent downward in direction of flow for piping NPS 3 and smaller; 1 percent downward in direction of flow for piping NPS 4 and larger.
2. Install cast-iron soil piping according to CISPI's "Cast Iron Soil Pipe and Fittings Handbook," Chapter IV, "Installation of Cast Iron Soil Pipe and Fittings."
 3. Plumbing Specialties:
 - a. Install cleanouts at grade and extend to where building storm drains connect to building storm sewers in sanitary waste gravity-flow piping.
 4. Do not enclose, cover, or put piping into operation until it is inspected and approved by authorities having jurisdiction.
 5. Install sleeves for piping penetrations of walls, ceilings, and floors.
 6. Install sleeve seals for piping penetrations of concrete walls and slabs.
 - a. Install escutcheons for piping penetrations of walls, ceilings, and floors.
 7. Joint Construction
 - a. Join hub-and-spigot, cast-iron soil piping with according to CISPI's "Cast Iron Soil Pipe and Fittings Handbook"
 - b. Join hubless, cast-iron soil piping according to CISPI 310 and CISPI's "Cast Iron Soil Pipe and Fittings Handbook" for hubless-piping coupling joints.
 - c. Threaded Joints: Thread pipe with tapered pipe threads according to ASME B1.20.1.
 - i. Cut threads full and clean using sharp dies.
 - ii. Ream threaded pipe ends to remove burrs and restore full ID. Join pipe fittings and valves as follows:
 - iii. Apply appropriate tape or thread compound to external pipe threads unless dry seal threading is specified.
 - iv. Damaged Threads: Do not use pipe or pipe fittings with threads that are corroded or damaged.
 - v. Do not use pipe sections that have cracked or open welds.
 - d. Grooved Joints: Cut groove ends of pipe according to AWWA C606. Lubricate and install gasket over ends of pipes or pipe and fitting. Install coupling housing sections, over gasket, with keys seated in piping grooves. Install and tighten housing bolts.

- e. Flanged Joints: Align bolt holes. Select appropriate gasket material, size, type, and thickness. Install gasket concentrically positioned. Use suitable lubricants on bolt threads. Torque bolts in cross pattern.
8. Specialty Pipe and Fittings
- a. Transition Couplings:
 - i. Install transition couplings at joints of piping with small differences in ODs.
 - ii. In Waste Drainage Piping: Shielded, nonpressure transition couplings.
 - iii. In Aboveground Force Main Piping: Fitting-type transition couplings.
 - iv. In Underground Force Main Piping:
 - v. NPS 1-1/2 and Smaller: Fitting-type transition couplings.
 - 1) NPS 2 and Larger: Pressure transition couplings.
 - b. Dielectric Fittings:
 - i. Install dielectric fittings in piping at connections of dissimilar metal piping and tubing.
 - ii. Dielectric Fittings for NPS 2 and Smaller: Use dielectric unions.
 - iii. Dielectric Fittings for NPS 2-1/2 to NPS 4 Use dielectric flanges or flange kits.

C.6 Storm Drainage Specialties

C.6.1 Installation

1. Install roof drains at low points of roof areas according to roof membrane manufacturer's written installation instructions.
 - a. Install flashing collar or flange of roof drain to prevent leakage between drain and adjoining roofing. Maintain integrity of waterproof membranes where penetrated.
 - b. Install expansion joints, if indicated, in roof drain outlets.
 - c. Position roof drains for easy access and maintenance.
2. Install cleanouts in aboveground piping and building drain piping according to the following instructions unless otherwise indicated:
 - a. Use cleanouts the same size as drainage piping.
 - b. Locate cleanouts at each change in direction of piping greater than 45 degrees.
 - c. Locate cleanouts at minimum intervals of 50 feet
 - d. Locate cleanouts at base of each vertical storm piping conductor.
3. For floor cleanouts for piping below floors, install cleanout deck plates with top flush with finished floor.
4. For cleanouts located in concealed piping, install cleanout wall access covers, of types indicated, with frame and cover flush with finished wall.
5. Install test tees in vertical conductors and near floor.
6. Install wall cleanouts in vertical conductors. Install access door in wall if indicated.
7. Install through-penetration firestop assemblies for penetrations of fire- and smoke-rated assemblies.

C.6.2 Flashing Installation

1. Fabricate flashing from single piece of metal unless large pans, sumps, or other drainage shapes are required.
2. Install sheet flashing on pipes, sleeves, and specialties passing through or embedded in floors and roofs with waterproof membrane.

3. Set flashing on floors and roofs in solid coating of bituminous cement.
4. Secure flashing into sleeve and specialty clamping ring or device.

C.6.3 Protection

1. Protect drains during remainder of construction period to avoid clogging with dirt or debris and to prevent damage from traffic or construction work.
 - a. Place plugs in ends of uncompleted piping at end of each day or when work stops.

C.7 Sump Pumps

C.7.1 Installation

1. Pump Installation Standards: Comply with HI 1.4 for installation of sump pumps.

C.7.2 Field Quality Control

1. Manufacturer's Field Service: Engage a factory-authorized service representative to test, inspect, and adjust components, assemblies, and equipment installations, including connections.
2. Perform the following tests and inspections:
 - a. Perform each visual and mechanical inspection.
 - b. Leak Test: After installation, charge system and test for leaks. Repair leaks and retest until no leaks exist.
 - c. Operational Test: After electrical circuitry has been energized, start units to confirm proper motor rotation and unit operation.
 - d. Test and adjust controls and safeties. Replace damaged and malfunctioning controls and equipment.
3. Pumps and controls will be considered defective if they do not pass tests and inspections.
4. Prepare test and inspection reports.

C.7.3 Startup Service

1. Engage a factory-authorized service representative to perform startup service.
 - a. Complete installation and startup checks according to manufacturer's written instructions.

C.7.4 Adjusting

1. Adjust pumps to function smoothly and lubricate as recommended by manufacturer.
 - a. Adjust control set points.

C.7.5 Demonstration

1. Engage a factory-authorized service representative to train Owner's maintenance personnel to adjust, operate, and maintain controls and pumps.

C.8 Electric Domestic Water Heaters

C.8.1 Installation

1. Install electric, domestic-water heaters level and plumb, according to layout drawings, original design, and referenced standards. Maintain manufacturer's recommended clearances. Arrange units so controls and devices needing service are accessible.
 - a. Install shutoff valves on domestic-water-supply piping to domestic-water heaters and on domestic-hot-water outlet piping.
2. Install combination temperature-and-pressure relief valves in top portion of storage tanks. Use relief valves with sensing elements that extend into tanks. Extend domestic-water heater relief-valve outlet, with drain piping same as domestic-water piping in continuous downward pitch, and discharge by positive air gap onto closest floor drain or sink.

3. Install combination temperature-and-pressure relief valves in water piping for electric, domestic-water heaters without storage. Extend domestic-water heater relief-valve outlet, with drain piping same as domestic-water piping in continuous downward pitch, and discharge by positive air gap onto closest floor drain.
4. Install water-heater drain piping as indirect waste to spill by positive air gap into open drains or over floor drains. Install hose-end drain valves at low points in water piping for electric, domestic-water heaters that do not have tank drains.
5. Install thermometers on outlet piping of electric, domestic-water heaters.
6. Install thermometers on inlet and outlet piping of domestic-water heaters.
7. Assemble and install inlet and outlet piping manifold kits for multiple electric, domestic-water heaters. Fabricate, modify, or arrange manifolds for balanced water flow through each electric, domestic-water heater. Include shutoff valve and thermometer in each domestic-water heater inlet and outlet, and throttling valve in each electric, domestic-water heater outlet.
8. Install piping-type heat traps on inlet and outlet piping of electric, domestic-water heater storage tanks without integral or fitting-type heat traps.
9. Fill electric, domestic-water heaters with water.
10. Charge domestic-water expansion tanks with air to required system pressure.
11. Install dielectric fittings in all locations where piping of dissimilar metals is to be joined. The wetted surface of the dielectric fitting contacted by potable water shall contain less than 0.25 percent of lead by weight.

C.8.2 Piping Connections

1. Where installing piping adjacent to electric, domestic-water heaters, allow space for service and maintenance of water heaters. Arrange piping for easy removal of domestic-water heaters.

C.8.3 Field Quality Control

1. Testing Agency: Owner will engage a qualified testing agency to perform tests and inspections.
2. Testing Agency: Engage a qualified testing agency to perform tests and inspections.
3. Manufacturer's Field Service: Engage a factory-authorized service representative to test and inspect components, assemblies, and equipment installations, including connections.
4. Perform tests and inspections.
5. Tests and Inspections:
 - a. Leak Test: After installation, charge system and test for leaks. Repair leaks and retest until no leaks exist.
 - b. Operational Test: After electrical circuitry has been energized, start units to confirm proper operation.
 - c. Test and adjust controls and safeties. Replace damaged and malfunctioning controls and equipment.
6. Electric, domestic-water heaters will be considered defective if they do not pass tests and inspections.
7. Prepare test and inspection reports.

C.8.4 Demonstration

1. Train Owner's maintenance personnel to adjust, operate, and maintain electric, domestic-water heaters. Training shall be a minimum of two hour(s).

C.9 Natural Gas Systems

C.9.1 Preparation

1. Close equipment shutoff valves before turning off natural gas to premises or piping section.
2. Inspect natural-gas piping according to the International Fuel Gas Code to determine that natural-gas utilization devices are turned off in piping section affected.
3. Comply with the International Fuel Gas Code requirements for prevention of accidental ignition.

C.9.2 Indoor Piping Installation

1. Comply with NFPA 54 for installation and purging of natural-gas piping.
2. Drawing plans, schematics, and diagrams indicate general location and arrangement of piping systems. Indicated locations and arrangements are used to size pipe and calculate friction loss, expansion, and other design considerations. Install piping as indicated unless deviations to layout are approved on Coordination Drawings.
3. Arrange for pipe spaces, chases, slots, sleeves, and openings in building structure during progress of construction, to allow for mechanical installations.
4. Install piping in concealed locations unless otherwise indicated and except in equipment rooms and service areas.
5. Install piping indicated to be exposed and piping in equipment rooms and service areas at right angles or parallel to building walls. Diagonal runs are prohibited unless specifically indicated otherwise.
6. Install piping above accessible ceilings to allow sufficient space for ceiling panel removal.
7. Locate valves for easy access.
8. Install natural-gas piping at uniform grade of 2 percent down toward drip and sediment traps.
9. Install piping free of sags and bends.
10. Install fittings for changes in direction and branch connections.
11. Verify final equipment locations for roughing-in.
12. Comply with requirements in Sections specifying gas-fired equipment for roughing-in requirements.
13. Use eccentric reducer fittings to make reductions in pipe sizes. Install fittings with level side down.
14. Connect branch piping from top or side of horizontal piping.
15. Install unions in pipes NPS 2 and smaller, adjacent to each valve, at final connection to each piece of equipment. Unions are not required at flanged connections.
16. Do not use natural-gas piping as grounding electrode.
17. Install strainer on inlet of each line-pressure regulator and automatic or electrically operated valve.
18. Install pressure gage upstream and downstream from each line regulator.
19. Install sleeves for piping penetrations of walls, ceilings, and floors.
20. Install sleeve seals for piping penetrations of concrete walls and slabs.
21. Install escutcheons for piping penetrations of walls, ceilings, and floors

C.9.3 Valve Installation

1. Install regulators and overpressure protection devices with maintenance access space adequate for servicing and testing.

C.9.4 Piping Joint Construction

1. Ream ends of pipes and tubes and remove burrs.
2. Remove scale, slag, dirt, and debris from inside and outside of pipe and fittings before assembly.
3. Threaded Joints:
 - a. Thread pipe with tapered pipe threads complying with ASME B1.20.1.
 - b. Cut threads full and clean using sharp dies.
 - c. Ream threaded pipe ends to remove burrs and restore full inside diameter of pipe.
 - d. Apply appropriate tape or thread compound to external pipe threads unless dryseal threading is specified.
 - e. Damaged Threads: Do not use pipe or pipe fittings with threads that are corroded or damaged. Do not use pipe sections that have cracked or open welds.
4. Welded Joints:
 - a. Construct joints according to AWS D10.12/D10.12M, using qualified processes and welding operators.
 - b. Bevel plain ends of steel pipe.
 - c. Patch factory-applied protective coating as recommended by manufacturer at field welds and where damage to coating occurs during construction.
5. Brazed Joints: Construct joints according to AWS's "Brazing Handbook," "Pipe and Tube" Chapter.
6. Flanged Joints: Install gasket material, size, type, and thickness appropriate for natural-gas service. Install gasket concentrically positioned.
7. Flared Joints: Cut tubing with roll cutting tool. Flare tube end with tool to result in flare dimensions complying with SAE J513. Tighten finger tight, then use wrench. Do not overtighten.

C.9.5 Hanger and Support Installation

1. Install hangers for steel piping, with maximum horizontal spacing and minimum rod diameters, to comply with MSS-58, locally enforced codes, and authorities having jurisdiction requirements, whichever are most stringent.
2. Support horizontal piping within 12 inches of each fitting.
3. Support vertical runs of steel piping to comply with MSS-58, locally enforced codes, and authorities having jurisdiction requirements, whichever are most stringent.

C.9.6 Connections

1. Connect to utility's gas main according to utility's procedures and requirements.
2. Install natural-gas piping electrically continuous and bonded to gas appliance equipment grounding conductor of the circuit powering the appliance according to NFPA 70.
3. Connect piping to appliances using manual gas shutoff valves and unions. Install valve within 72 inches of each gas-fired equipment. Install union between valve and appliances or equipment.
4. Sediment Traps: Install tee fitting with capped nipple in bottom to form drip, as close as practical to inlet of each appliance.

C.9.7 Labeling and Identifying

1. Install detectable warning tape directly above gas piping, 12 inches below finished grade, except 6 inches below subgrade under pavements and slabs.

C.9.8 Field Quality Control

1. Perform tests and inspections.
2. Tests and Inspections:
 - a. Test, inspect, and purge natural gas according to the International Fuel Gas Code and authorities having jurisdiction.
 - i Natural-gas piping will be considered defective if it does not pass tests and inspections
3. Prepare test and inspection reports.

C.9.9 Demonstration

1. Engage a factory-authorized service representative to train Owner's maintenance personnel to adjust, operate, and maintain earthquake valves.

C.9.10 Piping Schedule

1. Aboveground natural-gas piping shall be one of the following:
 - a. Steel pipe with malleable-iron fittings and threaded joints.
 - b. Steel pipe with wrought-steel fittings and welded joints.

C.9.11 Manual Shutoff Valve Schedule

1. Distribution piping valves for pipe sizes NPS 2 and smaller shall be one of the following:
 - a. One-piece, bronze ball valve with bronze trim.
 - b. Two-piece, full -port, bronze ball valves with bronze trim.
 - c. Bronze plug valve

C.10 Hangers and Supports

C.10.1 Application

1. Strength of Support Assemblies: Where not indicated, select sizes of components, so strength will be adequate to carry present and future static loads within specified loading limits. Minimum static design load used for strength determination shall be weight of supported components plus 200 lb.

C.10.2 Hanger Support and Installation

1. Metal Pipe-Hanger Installation: Comply with MSS SP-58. Install hangers, supports, clamps, and attachments as required to properly support piping from building structure.
2. Metal Trapeze Pipe-Hanger Installation: Comply with MSS SP-58. Arrange for grouping of parallel runs of horizontal piping, and support together on field-fabricated trapeze pipe hangers.
 - a. Pipes of Various Sizes: Support together and space trapezes for smallest pipe size, or install intermediate supports for smaller-diameter pipes as specified for individual pipe hangers.
 - b. Field fabricate from ASTM A36/A36M carbon-steel shapes selected for loads being supported. Weld steel according to AWS D1.1/D1.1M.
3. Metal Framing System Installation: Arrange for grouping of parallel runs of piping, and support together on field-assembled metal framing systems.
4. Thermal Hanger-Shield Installation: Install in pipe hanger or shield for insulated piping.
5. Fastener System Installation:
 - a. Install powder-actuated fasteners for use in lightweight concrete or concrete slabs less than 4 inches thick in concrete, after concrete is placed and completely cured. Use operators that are licensed by powder-actuated tool manufacturer. Install fasteners according to powder-actuated tool manufacturer's operating manual.
 - b. Install mechanical-expansion anchors in concrete, after concrete is placed and completely cured. Install fasteners according to manufacturer's written instructions.

6. Pipe Stand Installation:
 - a. Pipe Stand Types, except Curb-Mounted Type: Assemble components and mount on smooth roof surface. Do not penetrate roof membrane.
 - b. Curb-Mounted-Type Pipe Stands: Assemble components or fabricate pipe stand and mount on permanent, stationary roof curb. See Section "Roof Accessories" for curbs.
7. Pipe-Positioning-System Installation: Install support devices to make rigid supply and waste piping connections to each plumbing fixture.
8. Install hangers and supports complete with necessary attachments, inserts, bolts, rods, nuts, washers, and other accessories.
9. Equipment Support Installation: Fabricate from welded-structural-steel shapes.
10. Install hangers and supports to allow controlled thermal and seismic movement of piping systems, to permit freedom of movement between pipe anchors, and to facilitate action of expansion joints, expansion loops, expansion bends, and similar units.
11. Install lateral bracing with pipe hangers and supports to prevent swaying.
12. Install building attachments within concrete slabs or attach to structural steel. Install additional attachments at concentrated loads, including valves, flanges, and strainers, **NPS 2-1/2** and larger and at changes in direction of piping. Install concrete inserts before concrete is placed; fasten inserts to forms and install reinforcing bars through openings at top of inserts.
13. Load Distribution: Install hangers and supports, so that piping live and dead loads and stresses from movement will not be transmitted to connected equipment.
14. Pipe Slopes: Install hangers and supports to provide indicated pipe slopes and to not exceed maximum pipe deflections allowed by ASME B31.9 for building services piping.
15. Insulated Piping:
 - a. Attach clamps and spacers to piping.
 - i. Piping Operating Above Ambient Air Temperature: Clamp may project through insulation.
 - ii. Piping Operating Below Ambient Air Temperature: Use thermal hanger-shield insert with clamp sized to match OD of insert.
 - iii. Do not exceed pipe stress limits allowed by ASME B31.9 for building services piping.
 - b. Install MSS SP-58, Type 39 protection saddles if insulation without vapor barrier is indicated. Fill interior voids with insulation that matches adjoining insulation.
 - i. Option: Thermal hanger-shield inserts may be used. Include steel weight-distribution plate for pipe NPS 4 and larger if pipe is installed on rollers.
 - c. Install MSS SP-58, Type 40 protective shields on cold piping with vapor barrier. Shields shall span an arc of 180 degrees.
 - i. Option: Thermal hanger-shield inserts may be used. Include steel weight-distribution plate for pipe NPS 4 and larger if pipe is installed on rollers.
 - d. Shield Dimensions for Pipe: Not less than the following:
 - i. NPS 1/4 to NPS 3-1/2: 12 inches long and 0.048 inch thick.
 - ii. NPS 4: 12 inches long and 0.06 inch thick.
 - iii. NPS 5 and NPS 6: 18 inches long and 0.06 inch thick.
 - iv. NPS 8 to NPS 14: 24 inches long and 0.075 inch thick.
 - v. NPS 16 to NPS 24: 24 inches long and 0.105 inch thick.
 - e. Thermal Hanger Shields: Install with insulation of same thickness as piping insulation

C.10.3 Equipment Support

1. Fabricate structural-steel stands to suspend equipment from structure overhead or to support equipment above floor.
2. Grouting: Place grout under supports for equipment and make bearing surface smooth.
3. Provide lateral bracing, to prevent swaying, for equipment supports.

C.10.4 Metal Fabrication

1. Cut, drill, and fit miscellaneous metal fabrications for trapeze pipe hangers and equipment supports.
2. Fit exposed connections together to form hairline joints. Field weld connections that cannot be shop welded because of shipping size limitations.
3. Field Welding: Comply with AWS D1.1/D1.1M procedures for shielded, metal arc welding; appearance and quality of welds; and methods used in correcting welding work; and with the following:
 - a. Use materials and methods that minimize distortion and develop strength and corrosion resistance of base metals.
 - b. Obtain fusion without undercut or overlap.
 - c. Remove welding flux immediately.
 - d. Finish welds at exposed connections, so no roughness shows after finishing and so contours of welded surfaces match adjacent contours.

C.10.5 Adjusting

1. Hanger Adjustments: Adjust hangers to distribute loads equally on attachments and to achieve indicated slope of pipe.
 - a. Trim excess length of continuous-thread hanger and support rods to 1-1/2 inches.

C.10.6 Painting

1. Touchup: Clean field welds and abraded, shop-painted areas. Paint exposed areas immediately after erecting hangers and supports. Use same materials as those used for shop painting. Comply with SSPC-PA 1 requirements for touching up field-painted surfaces.
 - a. Apply paint by brush or spray to provide a minimum dry film thickness of 2.0 mils.
2. Touchup: Cleaning and touchup painting of field welds, bolted connections, and abraded, shop-painted areas on miscellaneous metal are specified
3. Galvanized Surfaces: Clean welds, bolted connections, and abraded areas, and apply galvanizing-repair paint to comply with ASTM A780/A780M.

C.10.7 Hangers and Support Schedule

1. Specific hanger and support requirements are in Sections specifying piping systems and equipment.
2. Comply with MSS SP-58 for pipe-hanger selections and applications that are not specified in piping system Sections.
3. Use hangers and supports with galvanized metallic coatings for piping and equipment that will not have field-applied finishes.
4. Use nonmetallic coatings on attachments for electrolytic protection where attachments are in direct contact with copper tubing.
5. Use carbon-steel pipe hangers and supports, metal trapeze pipe hangers and metal framing systems and attachments for general service applications.
6. Use stainless-steel pipe hangers and stainless-steel or corrosion-resistant attachments for hostile environment applications.

7. Use copper-plated pipe hangers and copper attachments for copper piping and tubing.
8. Use padded hangers for piping that is subject to scratching.
9. Use thermal hanger-shield inserts for insulated piping and tubing.
10. Horizontal-Piping Hangers and Supports: Unless otherwise indicated and except as specified in piping system Sections, install the following types:
 - a. Adjustable, Steel Clevis Hangers (MSS Type 1): For suspension of non-insulated or insulated, stationary pipes NPS 1/2 to NPS 30.
 - b. Carbon- or Alloy-Steel, Double-Bolt Pipe Clamps (MSS Type 3): For suspension of pipes NPS 3/4 to NPS 6, requiring clamp flexibility and up to 4 inches of insulation.
 - c. Steel Pipe Clamps (MSS Type 4): For suspension of cold and hot pipes NPS 1/2 to NPS 6 if little or no insulation is required.
 - d. Pipe Hangers (MSS Type 5): For suspension of pipes NPS 1/2 to NPS 4, to allow off-center closure for hanger installation before pipe erection.
 - e. Adjustable, Swivel Split- or Solid-Ring Hangers (MSS Type 6): For suspension of non-insulated, stationary pipes NPS 3/4 to NPS 8.
 - f. Adjustable, Steel Band Hangers (MSS Type 7): For suspension of non-insulated, stationary pipes NPS 1/2 to NPS 8).
 - g. Adjustable Band Hangers (MSS Type 9): For suspension of non-insulated, stationary pipes NPS 1/2 to NPS 8.
 - h. Adjustable, Swivel-Ring Band Hangers (MSS Type 10): For suspension of non-insulated, stationary pipes NPS 1/2 to NPS 8.
 - i. Split Pipe Ring with or without Turnbuckle Hangers (MSS Type 11): For suspension of non-insulated, stationary pipes NPS 3/8 to NPS 8.
 - j. Extension Hinged or Two-Bolt Split Pipe Clamps (MSS Type 12): For suspension of non-insulated, stationary pipes NPS 3/8 to NPS 3).
 - k. U-Bolts (MSS Type 24): For support of heavy pipes NPS 1/2 to NPS 30.
 - l. Clips (MSS Type 26): For support of insulated pipes not subject to expansion or contraction.
 - m. Pipe Saddle Supports (MSS Type 36): For support of pipes NPS 4 to NPS 36, with steel-pipe base stanchion support and cast-iron floor flange or carbon-steel plate.
 - n. Pipe Stanchion Saddles (MSS Type 37): For support of pipes NPS 4 to NPS 36, with steel-pipe base stanchion support and cast-iron floor flange or carbon-steel plate, and with U-bolt to retain pipe.
 - o. Adjustable Pipe Saddle Supports (MSS Type 38): For stanchion-type support for pipes NPS 2-1/2 to NPS 36 if vertical adjustment is required, with steel-pipe base stanchion support and cast-iron floor flange.
 - p. Single-Pipe Rolls (MSS Type 41): For suspension of pipes NPS 1 to NPS 30, from two rods if longitudinal movement caused by expansion and contraction occurs.
 - q. Adjustable Roller Hangers (MSS Type 43): For suspension of pipes NPS 2-1/2 to NPS 24, from single rod if horizontal movement caused by expansion and contraction occurs.
 - r. Complete Pipe Rolls (MSS Type 44): For support of pipes NPS 2 to NPS 8 if longitudinal movement caused by expansion and contraction occurs but vertical adjustment is unnecessary.
 - s. Pipe Roll and Plate Units (MSS Type 45): For support of pipes NPS 2 to NPS 24 if small horizontal movement caused by expansion and contraction occurs and vertical adjustment is unnecessary.

- t. Adjustable Pipe Roll and Base Units (MSS Type 46): For support of pipes NPS 2 to NPS 8 if vertical and lateral adjustment during installation, in addition to expansion and contraction, is required.
11. Vertical-Piping Clamps: Unless otherwise indicated and except as specified in piping system Sections, install the following types:
- a. Extension Pipe or Riser Clamps (MSS Type 8): For support of pipe risers NPS 3/4 to NPS 8
 - b. Carbon- or Alloy-Steel Riser Clamps (MSS Type 42): For support of pipe risers NPS 3/4 to NPS 8 if longer ends are required for riser clamps.
12. Hanger-Rod Attachments: Unless otherwise indicated and except as specified in piping system Sections, install the following types:
- a. Steel Turnbuckles (MSS Type 13): For adjustment of up to 6 inches for heavy loads.
 - b. Steel Clevises (MSS Type 14): For 120 to 450 deg F piping installations.
 - c. Malleable-Iron Sockets (MSS Type 16): For attaching hanger rods to various types of building attachments.
 - d. Steel Weldless Eye Nuts (MSS Type 17): For 120 to 450 deg F piping installations.
13. Building Attachments: Unless otherwise indicated and except as specified in piping system Sections, install the following types:
- a. Steel or Malleable-Concrete Inserts (MSS Type 18): For upper attachment to suspend pipe hangers from concrete ceiling.
 - b. Top-Beam C-Clamps (MSS Type 19): For use under roof installations with bar-joint construction, to attach to top flange of structural shape.
 - c. Side-Beam or Channel Clamps (MSS Type 20): For attaching to bottom flange of beams, channels, or angles.
 - d. Center-Beam Clamps (MSS Type 21): For attaching to center of bottom flange of beams.
 - e. Welded Beam Attachments (MSS Type 22): For attaching to bottom of beams if loads are considerable and rod sizes are large.
 - f. C-Clamps (MSS Type 23): For structural shapes.
 - g. Top-Beam Clamps (MSS Type 25): For top of beams if hanger rod is required tangent to flange edge.
 - h. Side-Beam Clamps (MSS Type 27): For bottom of steel I-beams.
 - i. Steel-Beam Clamps with Eye Nuts (MSS Type 28): For attaching to bottom of steel I-beams for heavy loads.
 - j. Linked-Steel Clamps with Eye Nuts (MSS Type 29): For attaching to bottom of steel I-beams for heavy loads, with link extensions.
 - k. Malleable-Beam Clamps with Extension Pieces (MSS Type 30): For attaching to structural steel.
 - l. Welded-Steel Brackets: For support of pipes from below or for suspending from above by using clip and rod. Use one of the following for indicated loads:
 - i Light (MSS Type 31): 750 lb.
 - ii Medium (MSS Type 32): 1500 lb.
 - iii Heavy (MSS Type 33): 3000 lb.
 - m. Side-Beam Brackets (MSS Type 34): For sides of steel or wooden beams.
 - n. Plate Lugs (MSS Type 57): For attaching to steel beams if flexibility at beam is required.
 - o. Horizontal Travelers (MSS Type 58): For supporting piping systems subject to linear horizontal movement where headroom is limited.

14. Saddles and Shields: Unless otherwise indicated and except as specified in piping system Sections, install the following types:
 - a. Steel-Pipe-Covering Protection Saddles (MSS Type 39): To fill interior voids with insulation that matches adjoining insulation.
 - b. Protection Shields (MSS Type 40): Of length recommended in writing by manufacturer to prevent crushing insulation.
 - c. Thermal Hanger-Shield Inserts: For supporting insulated pipe.
15. Spring Hangers and Supports: Unless otherwise indicated and except as specified in piping system Sections, install the following types:
 - a. Restraint-Control Devices (MSS Type 47): Where indicated to control piping movement.
 - b. Spring Cushions (MSS Type 48): For light loads if vertical movement does not exceed 1-1/4 inches
 - c. Spring-Cushion Roll Hangers (MSS Type 49): For equipping Type 41 roll hanger with springs.
 - d. Spring Sway Braces (MSS Type 50): To retard sway, shock, vibration, or thermal expansion in piping systems.
 - e. Variable-Spring Hangers (MSS Type 51): Preset to indicated load, and limit variability factor to 25 percent to allow expansion and contraction of piping system from hanger.
 - f. Variable-Spring Base Supports (MSS Type 52): Preset to indicated load, and limit variability factor to 25 percent to allow expansion and contraction of piping system from base support.
 - g. Variable-Spring Trapeze Hangers (MSS Type 53): Preset to indicated load, and limit variability factor to 25 percent to allow expansion and contraction of piping system from trapeze support.
 - h. Constant Supports: For critical piping stress and if necessary to avoid transfer of stress from one support to another support, critical terminal, or connected equipment. Include auxiliary stops for erection, hydrostatic test, and load-adjustment capability. These supports include the following types:
 - i Horizontal (MSS Type 54): Mounted horizontally.
 - ii Vertical (MSS Type 55): Mounted vertically.
 - iii Trapeze (MSS Type 56): Two vertical-type supports and one trapeze member.
 - i. Comply with MSS SP-58 for trapeze pipe-hanger selections and applications that are not specified in piping system Sections.
 - j. Comply with MFMA-103 for metal framing system selections and applications that are not specified in piping system Sections.
16. Use pipe-positioning systems in pipe spaces behind plumbing fixtures to support supply and waste piping for plumbing fixtures.

C.11 Natural Gas System Installation

C.11.1 Summary

1. Extent of work is limited to piping and accessories as required to extend natural gas line from meter to gas fired equipment as indicated on drawings and schedules as required by this section.
2. Contractor to verify gas pressure available with local natural gas utility and to provide piping system including gas pressure step down regulators as may be needed.

C.11.2 Installation of Natural Gas Piping

1. Use sealants on metal gas piping threads that are chemically resistant to natural gas. Use sealants sparingly and apply to only male threads of metal joints.
2. Remove cutting and threading burrs before assembling piping.

3. Do not install defective piping or fittings. Do not use pipe with threads that are chipped, stripped or damage.
4. Plug each gas outlet, including valves, with threaded plug or cap immediately after installation and retain until continuing piping, or equipment connections are completed.
5. Install drip legs in gas piping where indicated, and where required by code or regulation.
6. Install "tee" fittings with bottom outlet plugged or capped, at bottom of pipe risers.
7. Install piping with 1/64 inch per foot downward slope in direction of flow.
8. Install piping parallel to other piping, but maintain minimum of 12-inch clearance between gas piping and steam or hydronic piping above 200 deg F.
9. Install gas pressure regulator at equipment. Size for pressure leaving meter, required pressure at equipment and required flow. Vent per code to atmosphere. NOTE: Coordinate gas pressures provided and placement of step-down regulators where they may be required.
10. All pipe supports to be spaced a maximum of 5 feet.

C.11.3 Natural Gas Service

General: Coordinate with local gas utility company the connection of new loads to the existing natural gas service.

1. Coordinate available gas pressure and gas load the new service.
2. Coordinate with the utility the location of the new gas service.
3. Consult with utility as to extent of its work, costs, and fees associated with any service
4. size increases or modifications. Pay such costs and fees.
5. Verify pressure leaving the meter. Gas piping distribution system was sized based on the indicated pressure leaving the meter or at the building structure as shown on the plans. If needed modify the gas pipe size based on actual pressures being provided.

Provide step down gas regulators as required at each structure and as may be needed at each natural gas burning device/equipment.

C.11.4 Installation of Natural Gas Piping Specialties

Do not conceal any gas piping or specialties.

C.11.5 Installation of Valves

Gas Cocks: Provide at connection to gas train for each gas fired equipment item and on risers and branches where indicated.

Locate gas cocks where easily accessible, and where they will be protected from possible injury.

C.11.6 Equipment Connections

General: Connect gas piping to each gas fired equipment item with drip leg and shutoff gas cock.

Comply with equipment manufacturer's instructions.

Install any required step-down pressure regulators that may be required based on gas pressures supplied from gas meter to gas pressure requirements of equipment. Pipe any regulator vents to outside of building away from any O.A. intakes.

C.11.7 Field Quality Control

Piping Tests: Inspect, test, and purge natural gas systems according to NFPA 54.

C.11.8 Adjusting, Cleaning and Painting

Cleaning and Inspecting: Clean and inspect natural gas systems. Paint gas piping per this SPV, paragraph C.2.2.

C.12 Plumbing Valves

C.12.1 Valve Installation

1. Install valves with unions or flanges at each piece of equipment arranged to allow service, maintenance, and equipment removal without system shutdown.
2. Locate valves for easy access and provide separate support where necessary.
3. Install valves in horizontal piping with stem at or above center of pipe.
4. Install valves in position to allow full stem movement.
5. Check Valves: Install check valves for proper direction of flow.
 - a. Swing Check Valves: In horizontal position with hinge pin level.
6. Install valve tags.

C.12.2 General Requirements For Valve Applications

1. If valve applications are not indicated, use the following:
 - a. Pump-Discharge Check Valves:
 - b. NPS 2 and Smaller: Bronze swing check valves with bronze disc.
 - c. NPS 2-1/2 and Larger for Sanitary Waste: Iron swing check valves with lever and weight or spring.
2. If valves with specified CWP ratings are unavailable, the same types of valves with higher CWP ratings may be substituted.
3. End Connections:
 - a. For Copper Tubing, NPS 2 and Smaller: Threaded or soldered.
 - b. For Copper Tubing, NPS 2-1/2 to NPS 4 : Flanged or threaded.
 - c. For Steel Piping, NPS 2 and Smaller: Threaded.
 - d. For Steel Piping, NPS 2-1/2 to NPS 4: Flanged or threaded

C.12.3 Domestic Hot and Cold Water Valve Schedule

1. Brass ball valves, two-piece with full port and stainless steel trim. Provide with threaded or solder-joint ends.
2. Bronze ball valves, two-piece with full port and stainless steel trim. Provide with threaded or solder-joint ends.
3. Bronze ball valves, two-piece with regular port and stainless-steel trim.
4. Bronze gate valves, NRS, Class 125 with soldered or threaded ends.
5. Bronze gate valves, press ends.

C.13 Escutcheons For Plumbing Piping

C.13.1 Installation

1. Install escutcheons for piping penetrations of walls, ceilings, and finished floors.
2. Install escutcheons with ID to closely fit around pipe, tube, and insulation of insulated piping and with OD that completely covers opening.
 - a. Escutcheons for New Piping:
 - i Piping with Fitting or Sleeve Protruding from Wall: One-piece, deep pattern.
 - ii Chrome-Plated Piping: One-piece steel with polished, chrome-plated finish.
 - iii Insulated Piping: One-piece steel with polished, chrome-plated finish.

- iv Bare Piping at Wall and Floor Penetrations in Finished Spaces: One-piece steel with polished, chrome-plated finish.
 - v Bare Piping at Wall and Floor Penetrations in Finished Spaces: One-piece cast brass with polished, chrome-plated finish.
 - vi Bare Piping at Wall and Floor Penetrations in Finished Spaces: One-piece stamped steel with polished, chrome-plated finish.
 - vii Bare Piping at Ceiling Penetrations in Finished Spaces: One-piece steel with polished, chrome-plated finish.
 - viii Bare Piping at Ceiling Penetrations in Finished Spaces: One-piece cast brass with polished, chrome-plated finish.
 - ix Bare Piping at Ceiling Penetrations in Finished Spaces: One-piece stamped steel with polished, chrome-plated finish.
3. Install floor plates for piping penetrations of equipment-room floors.
 4. Install floor plates with ID to closely fit around pipe, tube, and insulation of piping and with OD that completely covers opening.
 - a. New Piping: One-piece, floor plate.

C.13.2 Field Quality Control

1. The use of chrome plated plastic escutcheons is not acceptable.
2. Using new materials, replace broken and damaged escutcheons and floor plates.

C.14 Identification for Plumbing Piping and Equipment

C.14.1 Preparation

1. Clean piping and equipment surfaces of substances that could impair bond of identification devices, including dirt, oil, grease, release agents, and incompatible primers, paints, and encapsulants.

C.14.2 General Installation Requirements

1. Coordinate installation of identifying devices with completion of covering and painting of surfaces where devices are to be applied.
2. Coordinate installation of identifying devices with locations of access panels and doors.
3. Install identifying devices before installing acoustical ceilings and similar concealment.

C.14.3 Equipment Label Installation

1. Pipe Label Locations: Locate pipe labels where piping is exposed or above accessible ceilings in finished spaces; machine rooms; accessible maintenance spaces such as shafts, tunnels, and plenums; and exterior exposed locations as follows:
 - a. Near each valve and control device.
 - b. Near each branch connection, excluding short takeoffs for fixtures and terminal units. Where flow pattern is not obvious, mark each pipe at branch.
 - c. Near penetrations through walls, floors, ceilings, and inaccessible enclosures.
 - d. At access doors, manholes, and similar access points that permit view of concealed piping.
 - e. Near major equipment items and other points of origination and termination.
 - f. Spaced at maximum intervals of 50 feet along each run. Reduce intervals to 25 feet in areas of congested piping and equipment.
 - g. On piping above removable acoustical ceilings. Omit intermediately spaced labels.
2. Directional Flow Arrows: Arrows shall be used to indicate direction of flow in pipes, including pipes where flow is allowed in both directions.

3. Pipe Label Color Schedule:
 - a. Domestic Water Piping
 - i Background: Safety green.
 - ii Letter Colors: White.
 - b. Sanitary Waste and Storm Drainage Piping:
 - i Background Color: Safety black
 - ii Letter Color: White
 - c. Natural Gas Piping
 - i Background: Safety yellow.
 - ii Letter Colors: Black.
 - d. All other piping not defined herein according to ANSI standards.

C.14.4 Valve Tag Installation

1. Install tags on valves and control devices in piping systems, except check valves, valves within factory-fabricated equipment units, shutoff valves, faucets, convenience and lawn-watering hose connections, and similar roughing-in connections of end-use fixtures and units. List tagged valves in a valve schedule.
 - a. Valve-Tag Application Schedule: Tag valves according to size, shape, and color scheme and with captions similar to those indicated in the following subparagraphs:
 - b. Valve-Tag Size and Shape:
 - i Cold Water: 1-1/2 inches, round.
 - ii Hot Water: 1-1/2 inches, round.
 - c. Valve-Tag Colors:
 - i Cold Water: Natural
 - 1) Hot Water: Natural
 - d. Letter Colors:
 - i Cold Water: White
 - 1) Hot Water: White

C.15 Plumbing Fixtures

1. Connect sinks with water supplies, stops, and with traps, soil, waste, and vent piping. Use size fittings required to match fixtures.

D Measurement

The department will measure Plumbing Work by a single unit for each project, acceptably completed.

E Payment

The department will pay for measured quantities at the contract unit price under the following bid item:

ITEM NUMBER	DESCRIPTION	UNIT
SPV.0060.22	Plumbing Work	EACH

Payment is full compensation for performing all the plumbing work.

43. Stairs, Item SPV.0060.23.

A Description

A.1 SUMMARY

- a. Section Includes:
 - i Preassembled steel pan stairs with concrete fill treads, epoxy sealant finish and abrasive nosing.
 - ii Steel tube railings and guards attached to metal stairs.
 - iii Stainless steel tube handrails attached to railings and walls adjacent to metal stairs.
 - iv Railing gates at the level of exit discharge.
 - v Steel grating stairs (bridge roof bulkhead area)

A.2 COORDINATION

- a. Coordinate selection of shop primers with topcoats to be applied over them. Comply with paint and coating manufacturers' written instructions to ensure that shop primers and topcoats are compatible with one another.
- b. Coordinate installation of anchorages for metal stairs, railings, and guards.
 - i Furnish setting drawings, templates, and directions for installing anchorages, including sleeves, concrete inserts, anchor bolts, blocking for attachment of wall-mounted handrails, and items with integral anchors, that are to be embedded in concrete or masonry.
 - ii Deliver such items to Project site in time for installation.
- c. Coordinate locations of hanger rods and struts with other work so they do not encroach on required stair width and are within fire-resistance-rated stair enclosure.
- d. Schedule installation of railings and guards so wall attachments are made only to completed walls.
 - i Do not support railings and guards temporarily by any means that do not satisfy structural performance requirements.

A.3 ACTION SUBMITTALS

- a. Product Data: For metal pan stairs and the following:
 - i Prefilled metal-pan-stair treads.
 - ii Grate steel stairs
 - iii Abrasive nosings.
 - iv Shop primer products.
 - v Nonslip-aggregate concrete finish.
 - vi Abrasive-coating finish to formed-metal stairs.
 - vii Handrail wall brackets.
 - viii Grout.
- b. Shop Drawings:
 - i Include plans, elevations, sections, details, and attachments to other work.
 - ii Indicate sizes of metal sections, thickness of metals, profiles, holes, and field joints.
 - iii Include plan at each level.

- iv Indicate locations of anchors, weld plates, and blocking for attachment of wall-mounted handrails.
- v Indicate profile and dimensions of precast treads.
- c. Samples for Verification: For each type and finish of nosing precast tread
- d. Delegated Design Submittal: For stairs, railings and guards, including analysis data signed and sealed by the qualified professional engineer responsible for their preparation.

A.4 INFORMATIONAL SUBMITTALS

- a. Qualification Data: For professional engineer's experience with providing delegated design engineering services of the kind indicated, including documentation that engineer is licensed in the State in which Project is located.
- b. Welding certificates.
- c. Paint Compatibility Certificates: From manufacturers of topcoats applied over shop primers, certifying that shop primers are compatible with topcoats.

A.5 QUALITY ASSURANCE

- a. Installer Qualifications: Fabricator of products.
- b. Welding Qualifications: Qualify procedures and personnel according to the following:
 - i AWS D1.1/D1.1M, "Structural Welding Code - Steel."
 - ii AWS D1.3/D1.3M, "Structural Welding Code - Sheet Steel."

A.6 DELIVERY, STORAGE, AND HANDLING

- a. Store materials to permit easy access for inspection and identification.
 - i Keep steel members off ground and spaced by using pallets, dunnage, or other supports and spacers.
 - ii Protect steel members and packaged materials from corrosion and deterioration.
 - iii Do not store materials on structure in a manner that might cause distortion, damage, or overload to members or supporting structures.
 - 1) Repair or replace damaged materials or structures as directed.

B Materials

B.1 PERFORMANCE REQUIREMENTS

- a. Delegated Design: Engage a qualified professional engineer, as defined in Section "Quality Requirements," to design stairs, railings and guards, precast treads, including attachment to building construction.
- b. Manufacturers: American Stair or Approved equal
- c. Structural Performance of Stairs: Metal stairs withstand the effects of gravity loads and the following loads and stresses within limits and under conditions indicated:
 - i Uniform Load: 150 lbf/sq. ft. (4.79 kN/sq. m).
 - ii Concentrated Load: 300 lbf (1.33 kN) applied on an area of 4 sq. in. (2580 sq. mm).
 - iii Uniform and concentrated loads need not be assumed to act concurrently.
 - iv Stair Framing: Capable of withstanding stresses resulting from railing and guard loads in addition to loads specified above.
 - v Limit deflection of treads, platforms, and framing members to L/360 or 1/4 inch (6.4 mm), whichever is less.

- d. Structural Performance of Railings and Guards: Railings and guards, including attachment to building construction, withstand the effects of gravity loads and the following loads and stresses within limits and under conditions indicated:
 - i Handrails and Top Rails of Guards:
 - 1) Uniform load of 75 lbf/ft. (0.73 kN/m) applied in any direction.
 - 2) Concentrated load of 250 lbf (0.89 kN) applied in any direction.
 - 3) Uniform and concentrated loads need not be assumed to act concurrently.
 - ii Infill of Guards:
 - 1) Concentrated load of 75 lbf (0.22 kN) applied horizontally on an area of 1 sq. foot. (0.093 sq. m).
 - 2) Infill load and other loads need not be assumed to act concurrently.
- e. Seismic Performance of Stairs: Metal stairs withstand the effects of earthquake motions determined according to ASCE/SEI 7
 - i Component Importance Factor:

B.2 METALS

- a. Metal Surfaces: Provide materials with smooth, flat surfaces unless otherwise indicated. For components exposed to view in the completed Work, provide materials without seam marks, roller marks, rolled trade names, or blemishes.
- b. Steel Plates, Shapes, and Bars: ASTM A36/A36M.
- c. Steel Tubing for Railings and Guards: ASTM A500/A500M (cold formed) or ASTM A513/A513M.
- d. Steel Pipe for Railings and Guards: ASTM A53/A53M, Type F or Type S, Grade A, Standard Weight (Schedule 40), unless another grade and weight are required by structural loads.
- e. Uncoated, Cold-Rolled Steel Sheet: ASTM A1008/A1008M, either commercial steel, Type B, structural steel, Grade 25 (Grade 170), unless another grade is required by design loads; exposed.
- f. Uncoated, Hot-Rolled Steel Sheet: ASTM A1011/A1011M, either commercial steel, Type B, or structural steel, Grade 30 (Grade 205), unless another grade is required by design loads.
- g. Galvanized Steel Sheet: ASTM A653/A653M, G90 (Z275) coating, either commercial steel, Type B, structural steel, Grade 33 (Grade 230), unless another grade is required by design loads.
- h. Expanded-Metal, Carbon Steel: ASTM F1267, Type I (expanded) Type II (expanded and flattened), Class 1 (uncoated).
 - i Style Designation: 3/4 number 13 1-1/2 number 10 .

B.3 ABRASIVE NOSINGS

- a. Cast-Metal Units: Cast aluminum with an integral abrasive, as-cast finish consisting of aluminum oxide, silicon carbide, or a combination of both. Fabricate units in lengths necessary to accurately fit openings or conditions.
 - i Configuration: Cross-hatched units, 3 inches (75 mm) 4 inches (100 mm) wide without lip.
- b. Extruded Units: Aluminum units with abrasive filler consisting of aluminum oxide, silicon carbide, or a combination of both, in an epoxy-resin binder. Fabricate units in lengths necessary to accurately fit openings or conditions.
 - i Provide ribbed units, with abrasive filler strips projecting 1/16 inch (1.5 mm) above aluminum extrusion.
 - ii Provide solid-abrasive units without ribs.

- iii Nosings, Square-Back Units: 1-7/8 inches (48 mm) 3 inches (75 mm) 4 inches (100 mm) wide, without lip.
- iv Nosings, Two-Piece Units: 3 inches (75 mm) wide, with subchannel for casting into concrete.
- c. Provide anchors for embedding units in concrete, either integral or applied to units, as standard with manufacturer.
- d. Apply bituminous paint to concealed surfaces of cast-metal units set into concrete.
- e. Apply clear lacquer to concealed surfaces of extruded units set into concrete.

B.4 FASTENERS

- a. General: Provide zinc-plated fasteners with coating complying with ASTM B633 or ASTM F1941/F1941M, Class Fe/Zn 12 for exterior use, and Class Fe/Zn 5 Type 304 stainless steel fasteners for exterior use and zinc-plated fasteners with coating complying with ASTM B633 or ASTM F1941/F1941M, Class Fe/Zn 5 where built into exterior walls.
 - i Select fasteners for type, grade, and class required.
- b. Fasteners for Anchoring Railings and Guards to Other Construction: Select fasteners of type, grade, and class required to produce connections suitable for anchoring railings and guards to other types of construction indicated and capable of withstanding design loads.
- c. Bolts and Nuts: Regular hexagon-head bolts, ASTM A307, Grade A; with hex nuts, ASTM A563 (ASTM A563M); and, where indicated, flat washers.
- d. Anchor Bolts: ASTM F1554, Grade 36, of dimensions indicated; with nuts, ASTM A563 (ASTM A563M); and, where indicated, flat washers.
- e. Post-Installed Anchors: Torque-controlled expansion anchors or chemical anchors capable of sustaining, without failure, a load equal to six times the load imposed when installed in unit masonry and four times the load imposed when installed in concrete, as determined by testing according to ASTM E488/E488M, conducted by a qualified independent testing agency.
 - i Material for Interior Locations: Carbon-steel components zinc plated to comply with ASTM B633 or ASTM F1941/F1941M, Class Fe/Zn 5, unless otherwise indicated.
 - ii Material for Exterior Locations and Where Stainless Steel Is Indicated: Alloy Group 1 (A1) Group 2 (A4) stainless steel bolts, ASTM F593, and nuts, ASTM F594 (ASTM F836M).

B.5 MISCELLANEOUS MATERIALS

- a. Handrail Wall Brackets: Cast stainless steel, center of rail 2-1/2 inches (63.5 mm) 3-1/8 inches (79.4 mm) from face of wall.
- b. Welding Electrodes: Comply with AWS requirements.
- c. Universal Shop Primer: Fast-curing, lead- and chromate-free, universal modified-alkyd primer complying with MPI#79 and compatible with topcoat.
 - i Use primer containing pigments that make it easily distinguishable from zinc-rich primer.
- d. Shop Primer for Galvanized Steel: Primer formulated for exterior use over zinc-coated metal and compatible with finish system indicated.
- e. Nonmetallic, Shrinkage-Resistant Grout: ASTM C1107/C1107M, factory-packaged, nonmetallic aggregate grout; recommended by manufacturer for interior exterior use; noncorrosive and nonstaining; mixed with water to consistency suitable for application and a 30-minute working time.

B.6 PREFILLED CONCRETE TREADS

- a. Concrete Materials and Properties: Comply with requirements in Section "Cast-in-Place Concrete" for normal-weight, air-entrained, ready-mix concrete with minimum 28-day compressive strength of 3000 psi (20 MPa) and maximum aggregate size of ½ inch (13 mm) unless otherwise indicated.
- b. Nonslip-Aggregate Concrete Finish: Factory-packaged abrasive aggregate made from fused, aluminum-oxide grits or crushed emery; rustproof and nonglazing; unaffected by freezing, moisture, or cleaning materials.
- c. Plain Steel Welded-Wire Reinforcement: ASTM A1064/A10645M, steel, 6 by 6 inches (152 by 152 mm), W1.4 by W1.4, unless otherwise indicated on Drawings.
- d. Reinforcement Supports: Bolsters, chairs, spacers, and other devices for spacing, supporting, and fastening welded-wire reinforcement in place.
- e. Manufacture bar supports from steel wire, plastic, or precast concrete according to CRSI's "Manual of Standard Practice," of greater compressive strength than concrete.

B.7 FABRICATION OF STEEL-FRAMED STAIRS

- a. NAAMM Stair Standard: Comply with NAAMM AMP 510, "Metal Stairs Manual," for Commercial Class, unless more stringent requirements are indicated.
- b. Stair Framing:
 - i Stringers: Fabricate of steel plates or steel channels or steel rectangular tubes as indicated on Drawings.
 - 1) Stringer Size: As required to comply with "Performance Requirements" Article As indicated on Drawings.
 - 2) Provide closures for exposed ends of channel and rectangular tube stringers.
 - 3) Finish: Shop primed Painted Galvanized.
 - ii Platforms: Construct of steel plate or steel channel or steel rectangular tube headers and miscellaneous framing members as required to comply with "Performance Requirements" Article indicated on Drawings.
 - 1) Provide closures for exposed ends of channel and rectangular tube framing.
 - 2) Finish: Shop primed Painted Galvanized.
 - iii Weld or bolt stringers to headers; weld or bolt framing members to stringers and headers. If using bolts, fabricate and join so bolts are not exposed on finished surfaces.
 - iv Where stairs are enclosed by gypsum board shaft-wall assemblies, provide hanger rods or struts to support landings from floor construction above or below.
 - 3) Locate hanger rods and struts where they do not encroach on required stair width and are within the fire-resistance-rated stair enclosure.
 - v Where masonry walls support metal stairs, provide temporary supporting struts designed for erecting steel stair components before installing masonry.
- c. Metal Pan Stairs: Form risers, subtread pans, and subplatforms to configurations shown from steel sheet of thickness needed to comply with performance requirements, but not less than 0.067 inch (1.7 mm).
 - i Steel Sheet, Uncoated: Cold Hot-rolled steel sheet unless otherwise indicated.
 - ii Directly weld metal pans to stringers; locate welds on top of subtreads where they will be concealed by concrete fill. Do not weld risers to stringers.
 - iii Attach risers and subtreads to stringers with brackets made of steel angles or bars. Weld brackets to stringers and attach metal pans to brackets by welding, riveting, or bolting.

- iv Shape metal pans to include nosing integral with riser.
- v Attach abrasive nosings to risers.
- vi At contractor's option, provide stair assemblies with metal pan subtreads filled with reinforced concrete during fabrication.
- vii Provide epoxy-resin-filled treads, reinforced with glass fibers, with non-slip-concrete aggregate finish to tread surface.
- viii Provide subplatforms of configuration indicated or, if not indicated, the same as subtreads. Weld subplatforms to platform framing.
 - 1) Smooth Soffit Construction: Construct subplatforms with flat metal under surfaces to produce smooth soffits.
- d. Abrasive-Coating-Finished, Formed-Metal Stairs: Form risers, treads, and platforms to configurations shown from steel sheet of thickness needed to comply with performance requirements, but not less than 0.097 inch (2.5 mm).
 - i Steel Sheet: Uncoated, hot-rolled steel sheet unless otherwise indicated.
 - ii Directly weld risers and treads to stringers; locate welds on underside of stairs.
 - iii Provide platforms of configuration indicated or, if not indicated, the same as treads. Weld platforms to platform framing.
 - iv Finish tread and platform surfaces with manufacturer's standard epoxy-bonded abrasive finish.

B.8 FABRICATION OF STAIR RAILINGS AND GUARDS

- a. Fabricate railings and guards to comply with requirements indicated for design, dimensions, details, finish, and member sizes, including wall thickness of member, post spacings, wall bracket spacing, and anchorage, but not less than that needed to withstand indicated loads.
 - i Rails and Posts: 1-5/8-inch- (41-mm-) diameter 1-1/2-inch- (38-mm-) square top and bottom rails and 1-1/2-inch- (38-mm-) square posts.
 - ii Picket Infill: 1/2-inch- (13-mm-) 3/4-inch- (19-mm-) round square pickets spaced to prohibit the passage of a 4-inch (100-mm) diameter sphere.
 - iii Expanded-Metal Infill: Expanded-metal panels edged with U-shaped channels made from steel sheet and not less than 0.043 inch (1.1 mm) thick. Orient expanded metal with long dimension of diamonds parallel to top rail perpendicular to top rail vertical.
 - iv Perforated-Metal Infill: Perforated-metal panels edged with U-shaped channels made from metal sheet, of same metal as perforated metal, and not less than 0.043 inch (1.1 mm) thick. Orient perforated metal with pattern parallel to top rail perpendicular to top rail horizontal vertical as indicated on Drawings.
 - v Gates: Form gates from steel tube of same size and shape as top rails, with infill to match guards. Provide with cam-type, self-closing spring hinges for fastening to wall and overlapping stop with rubber bumper to prevent gate from opening in direction opposite egress.
- b. Welded Connections: Fabricate railings and guards with welded connections.
 - i Fabricate connections that are exposed to weather in a manner that excludes water.
 - 1) Provide weep holes where water may accumulate internally.
 - ii Cope components at connections to provide close fit, or use fittings designed for this purpose.
 - iii Weld all around at connections, including at fittings.
 - iv Use materials and methods that minimize distortion and develop strength and corrosion resistance of base metals.

- v Obtain fusion without undercut or overlap.
 - vi Remove flux immediately.
 - vii Finish welds to comply with NOMMA's "Voluntary Joint Finish Standards" for Finish #2 - Completely sanded joint, some undercutting and pinholes are okay
- c. Form changes in direction of railings and guards as follows:
 - i By bending or by inserting prefabricated elbow fittings.
 - d. For changes in direction made by bending, use jigs to produce uniform curvature for each repetitive configuration required. Maintain cross section of member throughout entire bend without buckling, twisting, cracking, or otherwise deforming exposed surfaces of components.
 - e. Close exposed ends of railing and guard members with prefabricated end fittings.
 - f. Provide wall returns at ends of wall-mounted handrails unless otherwise indicated.
 - i Close ends of returns unless clearance between end of rail and wall is 1/4 inch (6 mm) or less.
 - g. Connect posts to stair framing by direct welding unless otherwise indicated.
 - h. Brackets, Flanges, Fittings, and Anchors: Provide wall brackets, end closures, flanges, miscellaneous fittings, and anchors for interconnecting components and for attaching to other work.
 - i Furnish inserts and other anchorage devices for connecting to concrete or masonry work.
 - ii For nongalvanized railings and guards, provide nongalvanized ferrous-metal fittings, brackets, fasteners, and sleeves, except galvanize anchors embedded in exterior masonry and concrete construction.
 - iii Provide type of bracket with flange tapped for concealed anchorage to threaded hanger bolt with predrilled hole for exposed bolt anchorage and that provides 1-1/2-inch (38-mm) clearance from inside face of handrail to finished wall surface.
 - i. Fillers: Provide fillers made from steel plate, or other suitably crush-resistant material, where needed to transfer wall bracket loads through wall finishes to structural supports.
 - i Size fillers to suit wall finish thicknesses and to produce adequate bearing area to prevent bracket rotation and overstressing of substrate.

2. FINISHES

- a. Finish metal stairs after assembly.
- b. Preparation for Shop Priming: Prepare uncoated, ferrous-metal surfaces to comply with SSPC-SP 3, "Power Tool Cleaning."
- c. Apply shop primer to uncoated surfaces of metal stair components, except those with galvanized finishes and those to be embedded in concrete or masonry unless otherwise indicated. Comply with SSPC-PA 1, "Paint Application Specification No. 1: Shop, Field, and Maintenance Painting of Steel," for shop painting.

C Construction

C.1 EXAMINATION

- a. Verify elevations of floors, bearing surfaces and locations of bearing plates, and other embedments for compliance with requirements.
 - i For wall-mounted railings, verify locations of concealed reinforcement within gypsum board and plaster assemblies.
- b. Proceed with installation only after unsatisfactory conditions have been corrected.

C.2 INSTALLATION OF METAL PAN STAIRS

- a. Fastening to In-Place Construction: Provide anchorage devices and fasteners where necessary for securing metal stairs to in-place construction.
 - i Include threaded fasteners for concrete and masonry inserts, through-bolts, lag bolts, and other connectors.
- b. Cutting, Fitting, and Placement: Perform cutting, drilling, and fitting required for installing metal stairs. Set units accurately in location, alignment, and elevation, measured from established lines and levels and free of rack.
- c. Install metal stairs by welding stair framing to steel structure or to weld plates cast into concrete unless otherwise indicated.
 - i Grouted Baseplates: Clean concrete- and masonry-bearing surfaces of bond-reducing materials, and roughen surfaces prior to setting plates.
 - 1) Clean bottom surface of plates.
 - 2) Set plates for structural members on wedges, shims, or setting nuts.
 - 3) Tighten anchor bolts after supported members have been positioned and plumbed.
 - 4) Do not remove wedges or shims but, if protruding, cut off flush with edge of plate before packing with grout.
 - 5) Promptly pack grout solidly between bearing surfaces and plates so no voids remain.
 - Neatly finish exposed surfaces; protect grout and allow to cure.
 - Comply with manufacturer's written installation instructions for shrinkage-resistant grouts.
- d. Provide temporary bracing or anchors in formwork for items that are to be built into concrete, masonry, or similar construction.
- e. Fit exposed connections accurately together to form hairline joints.
 - i Weld connections that are not to be left as exposed joints but cannot be shop welded because of shipping size limitations.
 - ii Do not weld, cut, or abrade surfaces of exterior units that have been hot-dip galvanized after fabrication and are for bolted or screwed field connections.
 - iii Comply with requirements for welding in "Fabrication, General" Article.
- f. Place and finish concrete fill for treads and platforms to comply with Section "Cast-in-Place Concrete."
 - i Install abrasive nosings with anchors fully embedded in concrete.
 - ii Center nosings on tread width.
- g. Install precast concrete treads with adhesive supplied by manufacturer.
- h. Install precast treads according to manufacturer's written instructions.

C.3 INSTALLATION OF RAILINGS AND GUARDS

- a. Adjust railing and guard systems before anchoring to ensure matching alignment at abutting joints with tight, hairline joints.
 - i Space posts at spacing indicated or, if not indicated, as required by design loads.
 - ii Plumb posts in each direction, within a tolerance of 1/16 inch in 3 feet (2 mm in 1 m).
 - iii Align rails and guards so variations from level for horizontal members and variations from parallel with rake of stairs for sloping members do not exceed 1/4 inch in 12 feet (6 mm in 3.5 m).

- iv Secure posts, rail ends, and guard ends to building construction as follows:
 - 1) Anchor posts to steel by welding or bolting to steel supporting members.
 - 2) Anchor handrail and guard ends to concrete and masonry with steel round flanges welded to rail and guard ends and anchored with post-installed anchors and bolts.
- b. Install railing gates level, plumb, and secure for full opening without interference.
 - i Attach hardware using tamper-resistant or concealed means.
 - ii Adjust hardware for smooth operation.
- c. Attach handrails to wall with wall brackets.
 - i Locate brackets as indicated or, if not indicated, at spacing required to support structural loads.
 - ii Secure wall brackets to building construction as required to comply with performance requirements. follows:
 - 1) For concrete and solid masonry anchorage, use drilled-in expansion shields and hanger or lag bolts.
 - 2) For hollow masonry anchorage, use toggle bolts.
 - 3) For wood stud partitions, use hanger or lag bolts set into studs or wood backing between studs. Coordinate with carpentry work to locate backing members.
 - 4) For steel-framed partitions, use hanger or lag bolts set into fire-retardant-treated wood backing between studs. Coordinate with stud installation to locate backing members.
 - 5) For steel-framed partitions, use self-tapping screws fastened to steel framing or to concealed steel reinforcements.
 - 6) For steel-framed partitions, use toggle bolts installed through flanges of steel framing or through concealed steel reinforcements.

2. REPAIR

- a. Touchup Painting:
 - i Immediately after erection, clean field welds, bolted connections, and abraded areas of shop paint, and paint exposed areas with same material as used for shop painting to comply with SSPC-PA 1 for touching up shop-painted surfaces.
 - 1) Apply by brush or spray to provide a minimum 2.0-mil (0.05-mm) dry film thickness.
 - ii Cleaning and touchup painting of field welds, bolted connections, and abraded areas of shop paint are specified in "Interior Painting."
- b. Repair of Galvanized Surfaces: Clean field welds, bolted connections, and abraded areas and repair galvanizing to comply with ASTM A780/A780M.

D Measurement

The department will measure Stairs as a single unit for each, acceptably completed.

E Payment

The department will pay for measured quantities at the contract unit price under the following bid item:

ITEM NUMBER	DESCRIPTION	UNIT
SPV.0060.23	Stairs	EACH

Payment is full compensation for furnishing and installation of all stairs in the project.

44. Rough Carpentry, Item SPV.0060.24.

A Description

A.1 SUMMARY

- a. Section Includes:
 - i Wood products.
 - ii Wood-preserved-treated lumber.
 - iii Fire-retardant-treated lumber.
 - iv Miscellaneous lumber.
 - v Plywood backing panels.
 - vi Sheathing

A.2 Description - Wood Products

1. DEFINITIONS

- a. Boards or Strips: Lumber of less than 2 inches nominal (38 mm actual) size in least dimension.
- b. Lumber grading agencies, and abbreviations used to reference them, include the following:
 - i NeLMA: Northeastern Lumber Manufacturers' Association.
 - ii NLGA: National Lumber Grades Authority.
 - iii SPIB: The Southern Pine Inspection Bureau.
 - iv WCLIB: West Coast Lumber Inspection Bureau.
 - v WWPA: Western Wood Products Association.

2. ACTION SUBMITTALS

- a. Product Data: For each type of process and factory-fabricated product. Indicate component materials and dimensions and include construction and application details.
 - i Include data for wood-preserved treatment from chemical treatment manufacturer and certification by treating plant that treated materials comply with requirements. Indicate type of preservative used and net amount of preservative retained.
 - ii Include data for fire-retardant treatment from chemical treatment manufacturer and certification by treating plant that treated materials comply with requirements. Include physical properties of treated materials based on testing by a qualified independent testing agency.
 - iii For fire-retardant treatments, include physical properties of treated lumber both before and after exposure to elevated temperatures, based on testing by a qualified independent testing agency according to ASTM D5664.
 - iv For products receiving a waterborne treatment, include statement that moisture content of treated materials was reduced to levels specified before shipment to Project site.

3. INFORMATIONAL SUBMITTALS

- a. Material Certificates:
 - i For dimension lumber specified to comply with minimum allowable unit stresses. Indicate species and grade selected for each use and design values approved by the ALSC Board of Review.
 - ii For preservative-treated wood products. Indicate type of preservative used and net amount of preservative retained.

4. DELIVERY, STORAGE, AND HANDLING

- a. Stack wood products flat with spacers beneath and between each bundle to provide air circulation. Protect wood products from weather by covering with waterproof sheeting, securely anchored. Provide for air circulation around stacks and under coverings.

A.3 Description - Sheathing

1. SUMMARY

- a. Section Includes:
 - i Wall sheathing.
 - ii Roof sheathing.
 - iii Parapet sheathing.
 - iv Sheathing joint-and-penetration treatment materials.

2. ACTION SUBMITTALS

- a. Product Data: For each type of process and factory-fabricated product. Indicate component materials and dimensions and include construction and application details.
 - i Include data for wood-preserved treatment from chemical treatment manufacturer and certification by treating plant that treated plywood complies with requirements. Indicate type of preservative used and net amount of preservative retained.
 - ii Include data for fire-retardant treatment from chemical treatment manufacturer and certification by treating plant that treated plywood complies with requirements. Include physical properties of treated materials.
 - iii For fire-retardant treatments, include physical properties of treated plywood both before and after exposure to elevated temperatures, based on testing by a qualified independent testing agency according to ASTM D5516.
 - iv For products receiving waterborne treatment, include statement that moisture content of treated materials was reduced to levels specified before shipment to Project site.
 - v For air-barrier and water-resistant glass-mat gypsum sheathing, include manufacturer's technical data and tested physical and performance properties of products.
- b. Sustainable Design Submittals:
- c. Shop Drawings: For air-barrier and water-resistant glass-mat gypsum sheathing assemblies.
 - i Show locations and extent of sheathing, accessories, and assemblies specific to Project conditions.
 - ii Include details for sheathing joints and cracks, counterflashing strips, penetrations, inside and outside corners, terminations, and tie-ins with adjoining construction.
 - iii Include details of interfaces with other materials that form part of air barrier.

3. INFORMATIONAL SUBMITTALS

- a. Qualification Data: For Installer. including list of ABAA-certified installers and supervisors employed by Installer, who work on Project and testing and inspecting agency.
- b. Product Certificates: From air-barrier and water-resistant glass-mat gypsum sheathing manufacturer, certifying compatibility of sheathing accessory materials with Project materials that connect to or that come in contact with the sheathing.
- c. Product Test Reports: For each air-barrier and water-resistant glass-mat gypsum sheathing assembly, indicating compliance with specified requirements, for tests performed by a qualified testing agency.

d. Evaluation Reports: For the following, from ICC-ES:

- i Wood-preservative-treated plywood.
- ii Fire-retardant-treated plywood.
- iii Foam-plastic sheathing.

e. Field quality-control reports.

4. QUALITY ASSURANCE

a. Installer Qualifications: An entity that employs installers and supervisors who are trained and approved by manufacturer of air-barrier and water-resistant glass-mat gypsum sheathing.

- i Installer is to be licensed by ABAA according to ABAA's Quality Assurance Program and is to employ ABAA-certified installers and supervisors on Project.

b. Testing Agency Qualifications:

- i For testing agency providing classification marking for fire-retardant-treated material, an inspection agency acceptable to authorities having jurisdiction that periodically performs inspections to verify that the material bearing the classification marking is representative of the material tested.
- ii For testing and inspecting agency providing tests and inspections related to air-barrier and water-resistant glass-mat gypsum sheathing: an independent agency, qualified according to ASTM E329 for testing indicated, and certified by Air Barrier Association of America, Inc.

5. PRECONSTRUCTION TESTING

a. Preconstruction Testing Service: Engage a qualified testing agency to perform preconstruction testing on field mockups.

b. Mockup Testing: Air-barrier and water-resistant glass-mat gypsum sheathing assemblies are to comply with performance requirements indicated, as evidenced by reports based on mockup testing by a qualified testing agency.

- i Air-Leakage-Location Testing: Mockups will be tested for evidence of air leakage according to ASTM E1186, chamber pressurization or depressurization with smoke tracers ASTM E1186, chamber depressurization with detection liquids.
- ii Air-Leakage-Volume Testing: Mockups will be tested for air-leakage rate according to ASTM E783 or ASTM E2357.
- iii Notify Architect seven days in advance of the dates and times when mockups will be tested.

6. DELIVERY, STORAGE, AND HANDLING

a. Stack panels flat with spacers beneath and between each bundle to provide air circulation. Protect sheathing from weather by covering with waterproof sheeting, securely anchored. Provide for air circulation around stacks and under coverings.

B Materials

B.1 Materials - Wood Products

1. WOOD PRODUCTS

a. Lumber: Comply with DOC PS 20 and applicable rules of grading agencies indicated. If no grading agency is indicated, comply with the applicable rules of any rules-writing agency certified by the ALSC Board of Review. Grade lumber by an agency certified by the ALSC Board of Review to inspect and grade lumber under the rules indicated.

- i Factory mark each piece of lumber with grade stamp of grading agency.
 - ii For exposed lumber indicated to receive a stained or natural finish, mark grade stamp on end or back of each piece or omit grade stamp and provide certificates of grade compliance issued by grading agency.
 - iii Where nominal sizes are indicated, provide actual sizes required by DOC PS 20 for moisture content specified. Where actual sizes are indicated, they are minimum dressed sizes for dry wood products.
 - iv Dress lumber, S4S, unless otherwise indicated.
- b. Maximum Moisture Content:
- i Boards: 19 percent.

2. WOOD-PRESERVATIVE-TREATED LUMBER

- a. Preservative Treatment by Pressure Process: AWPA U1, Use categories as follows:
- i UC3A (Commodity Specification A): Coated sawn products in exterior construction not in contact with ground but exposed to all weather cycles including intermittent wetting. Include all rough carpentry. the following items:
 - 1) Wood cants, nailers, curbs, equipment support bases, blocking, stripping, and similar members in connection with roofing, flashing, vapor barriers, and waterproofing.
 - 2) Wood framing members that are less than 18 inches (460 mm) above the ground in crawlspaces or unexcavated areas.
 - 3) Wood siding and trim.
 - ii UC3A (All Other Commodity Specifications): Coated products excluding sawn products in exterior construction not in contact with ground, exposed to all weather cycles but protected from liquid water. Include all rough carpentry. the following items:
 - 1) Wood cants, nailers, curbs, equipment support bases, blocking, stripping, and similar members in connection with roofing, flashing, vapor barriers, and waterproofing.
 - 2) Wood framing members that are less than 18 inches (460 mm) above the ground in crawlspaces or unexcavated areas.
 - 3) Wood floor plates that are installed over concrete slabs-on-grade.
 - 4) Wood siding and trim.
 - 5) Wood sheathing..
 - iii UC4A (Commodity Specification A): Non-critical sawn products in contact with ground and exposed to all weather cycles including continuous or prolonged wetting, and sawn products not in contact with ground but with ground contact-type hazards or that are critical or hard to replace. Include all rough carpentry. the following items:
 - 1) Wood framing members that are less than 6 inches (152 mm) above the ground.
 - 2) Joists and beams when they are difficult to maintain, repair, or replace and are critical to the performance and safety of the entire system/construction..
 - iv UC4A (All Other Commodity Specifications): Non-critical products excluding sawn products in contact with ground and exposed to all weather cycles, normal exposure conditions. Include all rough carpentry.
 - v For exposed items indicated to receive a stained or natural finish, chemical formulations are not to require incising, contain colorants, bleed through, or otherwise adversely affect finishes.
 - vi After treatment, redry boards dimension lumber to 19 percent maximum moisture content.

- b. Kiln-dry lumber after treatment to a maximum moisture content of 19 percent. Do not use material that is warped or that does not comply with requirements for untreated material.
- c. Mark lumber with treatment quality mark of an inspection agency approved by the ALSC Board of Review.
- d. Application: Treat all rough carpentry unless otherwise indicated.
 - i. Wood cants, nailers, curbs, equipment support bases, blocking, stripping, and similar members in connection with roofing, flashing, vapor barriers, and waterproofing.
 - ii. Wood sills, sleepers, blocking, furring, stripping, and similar concealed members in contact with masonry or concrete.
 - iii. Wood framing and furring attached directly to the interior of below-grade exterior masonry or concrete walls.
 - iv. Wood framing members that are less than 18 inches (460 mm) above the ground in crawlspaces or unexcavated areas.
 - v. Wood floor plates that are installed over concrete slabs-on-grade.

3. FIRE-RETARDANT-TREATED LUMBER

- a. General: Where fire-retardant-treated materials are indicated, materials are to comply with requirements in this article, that are acceptable to authorities having jurisdiction, and with fire-test-response characteristics specified as determined by testing identical products per test method indicated by a qualified testing agency.
- b. Fire-Retardant-Treated Lumber and Plywood by Pressure Process: Products with a flame-spread index of 25 or less when tested according to ASTM E84, and with no evidence of significant progressive combustion when the test is extended an additional 20 minutes, and with the flame front not extending more than 10.5 feet (3.2 m) beyond the centerline of the burners at any time during the test.
 - i. Treatment is not to promote corrosion of metal fasteners.
 - ii. Exterior Type: Treated materials are to comply with requirements specified above for fire-retardant-treated lumber and plywood by pressure process after being subjected to accelerated weathering according to ASTM D2898. Use for exterior locations and where indicated.
 - iii. Interior Type A: Treated materials are to have a moisture content of 28 percent or less when tested according to ASTM D3201/D3201M at 92 percent relative humidity. Use where exterior type is not indicated.
 - iv. Design Value Adjustment Factors: Treated lumber is to be tested according to ASTM D5664 and design value adjustment factors are to be calculated according to ASTM D6841. For enclosed roof framing, framing in attic spaces, and where high temperature fire-retardant treatment is indicated, provide material with adjustment factors of not less than 0.85 modulus of elasticity and 0.75 for extreme fiber in bending for Project's climatological zone.
- c. Kiln-dry lumber after treatment to maximum moisture content of 19 percent. Kiln-dry plywood after treatment to maximum moisture content of 15 percent.
- d. Identify fire-retardant-treated wood with appropriate classification marking of qualified testing agency and other information required by authorities having jurisdiction.
 - i. For exposed lumber indicated to receive a stained or natural finish, mark end or back of each piece or omit marking and provide certificates of treatment compliance issued by testing agency.
- e. Application: Treat all rough carpentry unless otherwise indicated. items indicated on Drawings, and the following:
 - i. Concealed blocking.
 - ii. Framing for non-load-bearing partitions.

- iii Framing for non-load-bearing exterior walls.
- iv Wood cants, nailers, curbs, equipment support bases, blocking, and similar members in connection with roofing.
- v Plywood backing panels.

4. MISCELLANEOUS LUMBER

- a. Provide miscellaneous lumber indicated and lumber for support or attachment of other construction, including the following:
 - i Blocking.
 - ii Nailers.
 - iii Rooftop equipment bases and support curbs.
 - iv Cants.
 - v Furring.
 - vi Grounds.
- b. Dimension Lumber Items: Construction or No. 2 Standard, Stud, or No. 3 grade lumber of any species. any of the following species: the following species:
 - i Hem-fir (north); NLGA.
 - ii Mixed southern pine or southern pine; SPIB.
 - iii Spruce-pine-fir; NLGA.
 - iv Hem-fir; WCLIB or WWPA.
 - v Spruce-pine-fir (south); NeLMA, WCLIB, or WWPA.
 - vi Western woods; WCLIB or WWPA.
 - vii Northern species; NLGA.
 - viii Eastern softwoods; NeLMA.
- c. Concealed Boards: 15 19 percent maximum moisture content and any of the following species and grades:
 - i Mixed southern pine or southern pine; No. 2 3 grade; SPIB.
 - ii Hem-fir or hem-fir (north); Construction or No. 2 Common Standard or No. 3 Common grade; NLGA, WCLIB, or WWPA.
 - iii Spruce-pine-fir (south) or spruce-pine-fir; Construction or No. 2 Common Standard or No. 3 Common grade; NeLMA, NLGA, WCLIB, or WWPA.
 - iv Eastern softwoods; No. 2 3 Common grade; NeLMA.
 - v Northern species; No. 2 3 Common grade; NLGA.
 - vi Western woods; Construction or No. 2 Common Standard or No. 3 Common grade; WCLIB or WWPA.
- d. Roofing Nailers: Structural- or No. 2-grade lumber or better; kiln-dried Douglas fir, southern pine, or wood having similar decay-resistant properties.
- e. For blocking not used for attachment of other construction, Utility, Stud, or No. 3 grade lumber of any species may be used provided that it is cut and selected to eliminate defects that will interfere with its attachment and purpose.
- f. For furring strips for installing plywood or hardboard paneling, select boards with no knots capable of producing bent-over nails and damage to paneling.

5. PLYWOOD BACKING PANELS

- a. Equipment Backing Panels: Plywood, DOC PS 1, Exterior, A-C Exterior, C-C Plugged Exposure 1, C-D Plugged, fire-retardant treated, in thickness indicated or, if not indicated, not less than 1/2-inch (13-mm) 3/4-inch (19-mm) nominal thickness.

6. FASTENERS

- a. General: Fasteners are to be of size and type indicated and comply with requirements specified in this article for material and manufacture. Provide nails or screws, in sufficient length, to penetrate not less than 1-1/2 inches (38 mm) into wood substrate.
 - i Where rough carpentry is exposed to weather, in ground contact, pressure-preservative treated, or in area of high relative humidity, provide fasteners with hot-dip zinc coating complying with ASTM A153/A153M or ASTM F2329 of Type 304 stainless steel.
 - ii For redwood, use brass/bronze stainless steel hot-dip galvanized-steel fasteners.
- b. Nails, Brads, and Staples: ASTM F1667.
- c. Power-Driven Fasteners: Fastener systems with an evaluation report acceptable to authorities having jurisdiction, based on ICC-ES AC70.
- d. Post-Installed Anchors: Fastener systems with an evaluation report acceptable to authorities having jurisdiction, based on ICC-ES AC01 ICC-ES AC58 ICC-ES AC193 or ICC-ES AC308 as appropriate for the substrate.

7. METAL FRAMING ANCHORS

- a. Post Bases: Adjustable-socket type for bolting in place with standoff plate to raise post 1 inch (25 mm) above base and with 2-inch- (50-mm-) minimum side cover, socket 0.062 inch (1.6 mm) thick, and standoff and adjustment plates 0.108 inch (2.8 mm) thick.
- b. Joist Ties: Flat straps, with holes for fasteners, for tying joists together over supports.
 - i Width: 3/4 inch (19 mm) 1-1/4 inches (32 mm).
 - ii Thickness: 0.050 inch (1.3 mm) 0.062 inch (1.6 mm).
 - iii Length: 16 inches (400 mm) 24 inches (600 mm) As indicated.
- c. Rafter Tie-Downs: Bent strap tie for fastening rafters or roof trusses to wall studs below, 1-1/2 inches (38 mm) wide by 0.050 inch (1.3 mm) thick. Tie fastens to side of rafter or truss, face of top plates, and side of stud below.
- d. Rafter Tie-Downs (Hurricane or Seismic Ties): Bent strap tie for fastening rafters or roof trusses to wall studs below, 2-1/4 inches (57 mm) wide by 0.062 inch (1.6 mm) thick. Tie fits over top of rafter or truss and fastens to both sides of rafter or truss, face of top plates, and side of stud below.
- e. Floor-to-Floor Ties: Flat straps, with holes for fasteners, for tying upper floor wall studs to band joists and lower floor studs, 1-1/4 inches (32 mm) wide by 0.050 inch (1.3 mm) thick by 36 inches (914 mm) long.
- f. Hold-Downs: Brackets for bolting to wall studs and securing to foundation walls with anchor bolts or to other hold-downs with threaded rods and designed with first of two bolts placed seven bolt diameters from reinforced base.
 - i Bolt Diameter: 5/8 inch (15.8 mm) 3/4 inch (19 mm).
 - ii Width: 2-1/2 inches (64 mm) 3-3/16 inches (81 mm).
 - iii Body Thickness: 0.108 inch (2.8 mm) 0.138 inch (3.5 mm).
 - iv Base Reinforcement Thickness: 0.108 inch (2.8 mm) 0.239 inch (6.1 mm).

- g. Wall Bracing:
 - i T-shaped bracing made for letting into studs in saw kerf, 1-1/8 inches (29 mm) wide by 9/16 inch (14 mm) deep by 0.034 inch (0.85 mm) thick with hemmed edges.
 - ii Angle bracing made for letting into studs in saw kerf, 15/16 by 15/16 by 0.040 inch (24 by 24 by 1 mm) thick with hemmed edges.
- h. Materials: Unless otherwise indicated, fabricate from the following materials:
 - i Galvanized-Steel Sheet: Hot-dip, zinc-coated steel sheet complying with ASTM A653/A653M, G60 (Z180) coating designation.
 - 1) Use for interior locations unless otherwise indicated.
 - ii Heavy-Galvanized-Steel Sheet: Hot-dip, zinc-coated steel sheet complying with ASTM A653/A653M; structural steel (SS), high-strength low-alloy steel Type A (HSLAS Type A), or high-strength low-alloy steel Type B (HSLAS Type B); G185 (Z550) coating designation; and not less than 0.036 inch (0.9 mm) thick.
 - 2) Use for wood-preservative-treated lumber and where indicated.
 - iii Stainless steel bars and shapes complying with ASTM A276/A276M, Type 304 Type 316.
 - 3) Use for exterior locations and where indicated.

8. MISCELLANEOUS MATERIALS

- a. Sill-Sealer Gaskets:
 - i Glass-fiber-resilient insulation, fabricated in strip form, for use as a sill sealer; 1-inch (25-mm) nominal thickness, compressible to 1/32 inch (0.8 mm); selected from manufacturer's standard widths to suit width of sill members indicated.
 - ii Closed-cell neoprene foam, 1/4 inch (6.4 mm) thick, selected from manufacturer's standard widths to suit width of sill members indicated.
 - iii Self-adhering sheet consisting of 64 mils (1.6 mm) of rubberized asphalt laminated on one side to a 4-mil- (0.10-mm-) thick, polyethylene-film reinforcement, and with release liner on adhesive side ; formulated for application with primer or surface conditioner that complies with VOC limits of authorities having jurisdiction.
- b. Flexible Flashing: Composite, self-adhesive, flashing product consisting of a pliable, butyl rubber or rubberized-asphalt compound, bonded to a high-density polyethylene film, aluminum foil, or spunbonded polyolefin to produce an overall thickness of not less than 0.025 inch (0.6 mm).
- c. Adhesives for Gluing Furring and Sleepers to Concrete or Masonry: Formulation complying with ASTM D3498 that is approved for use indicated by adhesive manufacturer.
- d. Water-Repellent Preservative: NWWDA-tested and -accepted formulation containing 3-iodo-2-propynyl butyl carbamate, combined with an insecticide containing chloropyrifos as its active ingredient.

B.2 Materials - Sheathing

1. PERFORMANCE REQUIREMENTS

- a. Fire-Resistance Ratings: As tested according to ASTM E119; testing by a qualified testing agency. Identify products with appropriate markings of applicable testing agency.
 - i Fire-Resistance Ratings: Indicated by design designations from UL's "Fire Resistance Directory" or from the listings of another qualified testing agency.
- b. Air-Barrier and Water-Resistant Glass-Mat Gypsum Sheathing Performance: Air-barrier and water-resistant glass-mat gypsum sheathing assembly, and seals with adjacent construction, are to be capable of performing as a continuous air barrier and as a liquid-water drainage plane flashed to discharge to the exterior incidental condensation or water penetration. Air-barrier assemblies are to be capable of accommodating substrate movement and of sealing

substrate expansion and control joints, construction material changes, penetrations, tie-ins to installed waterproofing, tie-ins to other installed air barriers, and transitions at perimeter conditions without deterioration and air leakage exceeding specified limits.

2. WOOD PANEL PRODUCTS

- a. Emissions: Products are to meet the testing and product requirements of the California Department of Public Health's "Standard Method for the Testing and Evaluation of Volatile Organic Chemical Emissions from Indoor Sources Using Environmental Chambers."
- b. Thickness: As needed to comply with requirements specified, but not less than thickness indicated.
- c. Factory mark panels to indicate compliance with applicable standard.

3. PRESERVATIVE-TREATED PLYWOOD

- a. Preservative Treatment by Pressure Process: AWPA U1; Use Category UC2 for interior construction not in contact with ground, Use Category UC3b for exterior construction not in contact with ground, and Use Category UC4a for items in contact with ground.
 - i Preservative Chemicals: Acceptable to authorities having jurisdiction and containing no arsenic or chromium.
- b. Mark plywood with appropriate classification marking of an inspection agency acceptable to authorities having jurisdiction.
- c. Application: Treat all plywood unless otherwise indicated. Treat items indicated on Drawings and plywood in contact with masonry or concrete or used with roofing, flashing, vapor barriers, and waterproofing.

4. FIRE-RETARDANT-TREATED PLYWOOD

- a. General: Where fire-retardant-treated materials are indicated, use materials complying with requirements in this article that are acceptable to authorities having jurisdiction and with fire-test-response characteristics specified as determined by testing identical products per test method indicated by a qualified testing agency.
- b. Fire-Retardant-Treated Plywood by Pressure Process: Products with a flame-spread index of 25 or less when tested according to ASTM E84, and with no evidence of significant progressive combustion when the test is extended an additional 20 minutes, and with the flame front not extending more than 10.5 feet (3.2 m) beyond the centerline of the burners at any time during the test.
 - i Use treatment that does not promote corrosion of metal fasteners.
 - ii Exterior Type: Treated materials are to comply with requirements specified above for fire-retardant-treated plywood by pressure process after being subjected to accelerated weathering according to ASTM D2898. Use for exterior locations and where indicated.
 - iii Interior Type A: Treated materials are to have a moisture content of 28 percent or less when tested according to ASTM D3201/D3201M at 92 percent relative humidity. Use where exterior type is not indicated.
 - iv Design Value Adjustment Factors: Treated lumber plywood is to be tested according to ASTM D5516 and design value adjustment factors are to be calculated according to ASTM D6305. Span ratings after treatment are to be not less than span ratings specified. For roof sheathing and where high-temperature fire-retardant treatment is indicated, span ratings for temperatures up to 170 deg F (76 deg C) are to be not less than span ratings specified.
- c. Kiln-dry material after treatment to a maximum moisture content of 15 percent. Do not use material that is warped or does not comply with requirements for untreated material.
- d. Identify fire-retardant-treated plywood with appropriate classification marking of qualified testing agency.

- e. Application: Treat all plywood unless otherwise indicated. Treat plywood indicated on Drawings, and the following:
 - i Roof and wall sheathing within 48 inches (1220 mm) of fire party walls.
 - ii Roof sheathing.

5. WALL SHEATHING

- a. Plywood Sheathing: DOC PS 1 Either DOC PS 1 or DOC PS 2, Exterior, Structural I Exterior Exposure 1, Structural I Exposure 1 sheathing.
 - i Span Rating: Not less than 20/0
 - ii Nominal Thickness: Not less than 11/32 inch (8.7 mm) 3/8 inch (9.5 mm) 1/2 inch (13 mm).
- b. Oriented-Strand-Board Sheathing: DOC PS 2, Exposure 1 sheathing.
 - i Span Rating: Not less than 20/0
 - ii Nominal Thickness: Not less than 5/16 inch (7.9 mm) 3/8 inch (9.5 mm) 1/2 inch (13 mm).
- c. Paper-Surfaced Gypsum Sheathing: ASTM C1396/C1396M, gypsum sheathing; with water-resistant-treated core and with water-repellent paper bonded to core's face, back, and long edges.
 - i Type and Thickness: Regular, 1/2 inch (13 mm) Type X, 5/8 inch (15.9 mm) thick.
 - ii Edge and End Configuration: V-shaped, tongue-and-groove long edges; square ends Square.
 - iii Size: 24 by 96 inches (610 by 2438 mm) for horizontal 48 by 96 inches (1219 by 2438 mm) for vertical 48 by 108 inches (1219 by 2743 mm) for vertical 600 by 2400 mm for horizontal 1200 by 2400 mm for vertical 1200 by 2750 mm for vertical installation.
- d. Glass-Mat Gypsum Sheathing, Walls: ASTM C1177/C1177M.
 - i Type and Thickness: Regular, 1/2 inch (13 mm) Type X, 5/8 inch (15.9 mm) thick.
 - ii Size: 48 by 96 inches (1219 by 2438 mm) 48 by 108 inches (1219 by 2743 mm) 48 by 120 inches (1219 by 3048 mm) 1200 by 2400 mm 1200 by 2750 mm 1200 by 3050 mm for vertical installation.
- e. Air-Barrier and Water-Resistant Glass-Mat Gypsum Sheathing: ASTM C1177/C1177M, Type X, coated fiberglass mat gypsum sheathing with integral weather-resistant barrier and air barrier complying with ASTM E2178.
 - i Thickness: 5/8 inch (15.9 mm) thick.
 - ii Size: 48 by 96 inches (1219 by 2438 mm) 48 by 108 inches (1219 by 2743 mm) 48 by 120 inches (1219 by 3048 mm) 1200 by 2400 mm 1200 by 2750 mm 1200 by 3050 mm for vertical installation.
 - iii Edges: Square.
 - iv Flashing and Transitions Strips: As acceptable to sheathing manufacturer.
 - v Air Permeance: Maximum 0.004 cfm/sq. ft. of surface area at 1.57-lbf/sq. ft. (0.02 L/s x sq. m of surface area at 75-Pa) pressure difference when tested according to ASTM E2178.
 - vi Vapor Permeance: Minimum 20 perms (580 ng/Pa x s x sq. m) when tested according to ASTM E96/E96M, Desiccant Method, Procedure A.
 - vii Sheathing Assembly Air Leakage: Maximum 0.04 cfm/sq. ft. of surface area at 1.57 lbf/sq. ft. (0.2 L/s x sq. m of surface area at 75 Pa) when tested according to ASTM E2357.

- viii Fire Propagation Characteristics: Complies with NFPA 285 testing as part of an approved assembly.
 - ix Provide primers, transition strips, termination strips, joint reinforcing fabric and strips, joint sealants, counterflashing strips, flashing sheets and metal termination bars, termination mastic, substrate patching materials, adhesives, tapes, foam sealants, lap sealants, and other accessory materials that are recommended in writing by sheathing manufacturer to produce a complete air-barrier assembly and that are compatible with primary air-barrier material and adjacent construction to which they may seal.
- f. Cellulose Fiber-Reinforced Gypsum Sheathing: ASTM C1278/C1278M, gypsum sheathing.
- i Product: Subject to compliance with requirements, provide "Fiberock Sheathing with Aqua-Tough" by United States Gypsum Co.
 - ii Type and Thickness: Regular, 1/2 inch (13 mm) Type X, 5/8 inch (15.9 mm) thick.
 - iii Size: 48 by 96 inches (1219 by 2438 mm) 48 by 108 inches (1219 by 2743 mm) 48 by 120 inches (1219 by 3048 mm) 1200 by 2400 mm 1200 by 2750 mm 1200 by 3050 mm.
- g. Cementitious Backer Units, Walls: ASTM C1325, Type A.
- i Thickness: 1/2 inch (12.7 mm) 5/8 inch (15.9 mm) As indicated.
- h. Fiberboard Sheathing: ASTM C208, Type IV, Grade 1 (Regular) Grade 2 (Structural) cellulosic fiberboard sheathing with square edges, 1/2 inch (13 mm) 25/32 inch (20 mm) thick.
- i. Extruded-Polystyrene-Foam Sheathing: ASTM C578, Type IV, in manufacturer's standard lengths and widths with tongue-and-groove or shiplap long edges as standard with manufacturer.
- i Thickness: 3/4 inch (19 mm) 1 inch (25 mm) As indicated.
 - ii Flame Propagation Test: Materials and construction are to be tested according to NFPA 285.
- j. Foil-Faced, Polyisocyanurate-Foam Sheathing: ASTM C1289, Type I or Type II, Class 2, rigid, cellular, polyisocyanurate thermal insulation. Foam-plastic core and facings are to have a flame-spread index of 25 or less when tested individually.
- i Thickness: 7/16 inch (11.1 mm) 1/2 inch (13 mm) 5/8 inch (15.9 mm) 3/4 inch (19 mm) 1 inch (25 mm) As indicated.
 - ii Flame Propagation Test: Materials and construction are to be tested according to NFPA 285.
6. ROOF SHEATHING
- a. Plywood Sheathing: DOC PS 1 Either DOC PS 1 or DOC PS 2, Exterior, Structural I Exterior Exposure 1, Structural I Exposure 1 sheathing.
- i Span Rating: Not less than 16/0 20/0 24/0 32/16 40/20 48/24.
 - ii Nominal Thickness: Not less than 15/32 inch (11.9 mm) 1/2 inch (13 mm).
- b. Oriented-Strand-Board Sheathing: DOC PS 2, Exposure 1 sheathing.
- i Span Rating: Not less than 24/0
 - ii Nominal Thickness: Not less than 7/16 inch (11.1 mm) 15/32 inch (11.9 mm) 1/2 inch (13 mm) 5/8 inch (16 mm) 3/4 inch (19 mm).
7. PARAPET SHEATHING
- a. Plywood Sheathing: Exterior Exposure 1 sheathing.
- i Span Rating: Not less than 24/0 32/16
 - ii Nominal Thickness: Not less than 15/32 inch (11.9 mm) 1/2 inch (13 mm).

- b. Oriented-Strand-Board Sheathing: DOC PS 2, Exposure 1, Structural I Exposure 1 sheathing.
 - i Span Rating: Not less than 24/0
 - ii Nominal Thickness: Not less than 7/16 inch (11.1 mm) 15/32 inch (11.9 mm) 1/2 inch (13 mm) 5/8 inch (16 mm) 3/4 inch (19 mm).
- c. Glass-Mat Gypsum Sheathing, Parapets: ASTM C1177/C1177M.
 - i Type and Thickness: Regular, 1/2 inch (13 mm) Type X, 5/8 inch (15.9 mm) thick.
 - ii Size: 48 by 96 inches (1219 by 2438 mm) 48 by 108 inches (1219 by 2743 mm) 48 by 120 inches (1219 by 3048 mm) 1200 by 2400 mm 1200 by 2750 mm 1200 by 3050 mm for vertical installation.
- d. Cementitious Backer Units, Parapets: ASTM C1325, Type A.
 - i Thickness: 1/2 inch (12.7 mm) 5/8 inch (15.9 mm) As indicated.

8. FASTENERS

- a. General: Provide fasteners of size and type indicated that comply with requirements specified in this article for material and manufacture.
 - i For roof parapet and wall sheathing, provide fasteners with hot-dip zinc coating complying with ASTM A153/A153M of Type 304 stainless steel.
 - ii For roof parapet and wall sheathing, provide fasteners with organic-polymer or other corrosion-protective coating having a salt-spray resistance of more than 800 hours according to ASTM B117.
- b. Nails, Brads, and Staples: ASTM F1667.
- c. Power-Driven Fasteners: Fastener systems with an evaluation report acceptable to authorities having jurisdiction, based on ICC-ES AC70.
- d. Screws for Fastening Sheathing to Wood Framing: ASTM C1002.
- e. Screws for Fastening Wood Structural Panels to Cold-Formed Metal Framing: ASTM C954, except with wafer heads and reamer wings, length as recommended by screw manufacturer for material being fastened.
- f. Screws for Fastening Gypsum Sheathing to Cold-Formed Metal Framing: Steel drill screws, in length recommended by sheathing manufacturer for thickness of sheathing to be attached.
 - i For steel framing less than 0.0329 inch (0.835 mm) thick, use screws that comply with
 - ii For steel framing from 0.033 to 0.112 inch (0.84 to 2.84 mm) thick, use screws that comply with ASTM C954.
- g. Screws for Fastening Composite Nail Base Insulated Roof Sheathing to Metal Roof Deck: Steel drill screws, in type and length recommended by sheathing manufacturer for thickness of sheathing to be attached, with organic-polymer or other corrosion-protective coating having a salt-spray resistance of more than 800 hours according to ASTM B117. Provide washers or plates if recommended by sheathing manufacturer.

9. SHEATHING JOINT-AND-PENETRATION TREATMENT MATERIALS

- a. Sealant for Paper-Surfaced and Glass-Mat Gypsum Sheathing: Elastomeric, medium-modulus, neutral-curing silicone joint sealant compatible with joint substrates formed by gypsum sheathing and other materials, recommended by sheathing manufacturer for application indicated and complying with requirements for elastomeric sealants specified in Section "Joint Sealants."
- b. Sealant for Glass-Mat Gypsum Sheathing: Silicone emulsion sealant complying with ASTM C834, compatible with sheathing tape and sheathing and recommended by tape and sheathing manufacturers for use with glass-fiber sheathing tape and for covering exposed fasteners.

- i Sheathing Tape: Self-adhering glass-fiber tape, minimum 2 inches (50 mm) wide, 10 by 10 or 10 by 20 threads/inch (390 by 390 or 390 by 780 threads/m), of type recommended by sheathing and tape manufacturers for use with silicone emulsion sealant in sealing joints in glass-mat gypsum sheathing and with a history of successful in-service use.
- c. Sheathing Tape for Foam-Plastic Sheathing: Pressure-sensitive plastic tape recommended by sheathing manufacturer for sealing joints and penetrations in sheathing.

10. MISCELLANEOUS MATERIALS

- a. Adhesives for Field Gluing Panels to Wood Framing: Formulation complying with APA AFG-01 ASTM D3498 that is approved for use with type of construction panel indicated by manufacturers of both adhesives and panels.

C Construction

C.1 Wood Products Construction

1. INSTALLATION

- a. Framing Standard: Comply with AF&PA's WCD 1, "Details for Conventional Wood Frame Construction," unless otherwise indicated.
- b. Set work to required levels and lines, with members plumb, true to line, cut, and fitted. Fit rough carpentry accurately to other construction. Locate furring, nailers, blocking, grounds, and similar supports to comply with requirements for attaching other construction.
- c. Install plywood backing panels by fastening to studs; coordinate locations with utilities requiring backing panels. Install fire-retardant-treated plywood backing panels with classification marking of testing agency exposed to view.
- d. Install metal framing anchors to comply with manufacturer's written instructions. Install fasteners through each fastener hole.
- e. Install sill sealer gasket to form continuous seal between sill plates and foundation walls.
- f. Install sill sealer gasket/termite barrier according to manufacturer's written instructions at the underside of wall bottom track or rim track and at the top of foundation wall or slab at stud or joist locations.
- g. Do not splice structural members between supports unless otherwise indicated.
- h. Provide blocking and framing as indicated and as required to support facing materials, fixtures, specialty items, and trim.
 - i Provide metal clips for fastening gypsum board or lath at corners and intersections where framing or blocking does not provide a surface for fastening edges of panels. Space clips not more than 16 inches (406 mm) o.c.
- i. Provide fire blocking in furred spaces, stud spaces, and other concealed cavities as indicated and as follows:
 - i Fire block furred spaces of walls, at each floor level, at ceiling, and at not more than 96 inches (2438 mm) o.c. with solid wood blocking or noncombustible materials accurately fitted to close furred spaces.
 - ii Fire block concealed spaces of wood-framed walls and partitions at each floor level, at ceiling line of top story, and at not more than 96 inches (2438 mm) o.c. Where fire blocking is not inherent in framing system used, provide closely fitted solid wood blocks of same width as framing members and 2-inch nominal (38-mm actual) thickness.
 - iii Fire block concealed spaces between floor sleepers with same material as sleepers to limit concealed spaces to not more than 100 sq. feet (9.3 sq. m) and to solidly fill space below partitions.
 - iv Fire block concealed spaces behind combustible cornices and exterior trim at not more than 20 feet (6 m) o.c.

- j. Sort and select lumber so that natural characteristics do not interfere with installation or with fastening other materials to lumber. Do not use materials with defects that interfere with function of member or pieces that are too small to use with minimum number of joints or optimum joint arrangement.
 - k. Comply with AWWPA M4 for applying field treatment to cut surfaces of preservative-treated lumber.
 - i. Use inorganic boron for items that are continuously protected from liquid water.
 - ii. Use copper naphthenate for items not continuously protected from liquid water.
 - l. Where wood-preservative-treated lumber is installed adjacent to metal decking, install continuous flexible flashing separator between wood and metal decking.
 - m. Securely attach rough carpentry work to substrate by anchoring and fastening as indicated, complying with the following:
 - i. Table 2304.10.1, "Fastening Schedule," in ICC's International Building Code (IBC).
 - ii. Table R602.3(1), "Fastener Schedule for Structural Members," and Table R602.3(2), "Alternate Attachments," in ICC's International Residential Code for One- and Two-Family Dwellings.
 - iii. ICC-ES evaluation report for fastener.
 - n. Securely attach roofing nailers to substrates by anchoring and fastening to withstand bending, shear, or other stresses imparted by Project wind loads and fastener-resistance loads as designed according to ASCE/SEI 7.
 - o. Use steel common nails unless otherwise indicated. Select fasteners of size that will not fully penetrate members where opposite side will be exposed to view or will receive finish materials. Make tight connections between members. Install fasteners without splitting wood. Drive nails snug but do not countersink nail heads unless otherwise indicated.
2. INSTALLATION OF WOOD BLOCKING AND NAILERS
- a. Install where indicated and where required for screeding or attaching other work. Form to shapes indicated and cut as required for true line and level of attached work. Coordinate locations with other work involved.
 - b. Attach wood blocking to substrates to support applied loading. Recess bolts and nuts flush with surfaces unless otherwise indicated.
 - c. Attach wood roofing nailers securely to substrate to resist the designed outward and upward wind loads indicated on Drawings and according to ANSI/SPRI ED-1, Tables A6 and A7.
 - d. Provide permanent grounds of dressed, pressure-preservative-treated, key-beveled lumber not less than 1-1/2 inches (38 mm) wide and of thickness required to bring face of ground to exact thickness of finish material. Remove temporary grounds when no longer required.
3. INSTALLATION OF WOOD FURRING
- a. Install level and plumb with closure strips at edges and openings. Shim with wood as required for tolerance of finish work.
 - b. Furring to Receive Plywood or Hardboard Paneling: Install 1-by-3-inch nominal- (19-by-63-mm actual-) size furring horizontally and vertically at 24 inches (610 mm) 600 mm o.c.
 - c. Furring to Receive Gypsum Board or Plaster Lath: Install 1-by-2-inch nominal- (19-by-38-mm actual-) size furring vertically at 16 inches (406 mm) 400 mm o.c.

C.2 Sheathing Construction

1. INSTALLATION, GENERAL
- a. Do not use materials with defects that impair quality of sheathing or pieces that are too small to use with minimum number of joints or optimum joint arrangement. Arrange joints so that pieces do not span between fewer than three support members.

- b. Cut panels at penetrations, edges, and other obstructions of work; fit tightly against abutting construction unless otherwise indicated.
- c. Securely attach to substrate by fastening as indicated, complying with the following:
 - i Table 2304.10.1, "Fastening Schedule," in the ICC's International Building Code.
- d. Use common wire nails unless otherwise indicated. Select fasteners of size that will not fully penetrate members where opposite side will be exposed to view or will receive finish materials. Make tight connections. Install fasteners without splitting wood.
- e. Coordinate wall parapet and roof sheathing installation with flashing and joint-sealant installation so these materials are installed in sequence and manner that prevent exterior moisture from passing through completed assembly.
- f. Do not bridge building expansion joints; cut and space edges of panels to match spacing of structural support elements.
- g. Coordinate sheathing installation with installation of materials installed over sheathing so sheathing is not exposed to precipitation or left exposed at end of the workday when rain is forecast.

2. INSTALLATION OF WOOD PANELS

- a. General: Comply with applicable recommendations in APA Form No. E30, "Engineered Wood Construction Guide," for types of structural-use panels and applications indicated.
- b. Fastening Methods: Fasten panels as indicated below:
 - i Wall and Roof Sheathing:
 - 1) Nail Nail or staple to wood framing. Apply a continuous bead of glue to framing members at edges of wall sheathing panels.
 - 2) Screw to cold-formed metal framing.
 - 3) Space panels 1/8 inch (3 mm) apart at edges and ends.
 - ii Underlayment:
 - 1) Nail Nail or staple to subflooring.
 - 2) Space panels 1/32 inch (0.8 mm) apart at edges and ends.
 - 3) Fill and sand edge joints of underlayment receiving resilient flooring immediately before installing flooring.

3. INSTALLATION OF GYPSUM SHEATHING

- a. Comply with GA-253 and with manufacturer's written instructions.
 - i Fasten gypsum sheathing to wood framing with screws.
 - ii Fasten gypsum sheathing to cold-formed metal framing with screws.
 - iii Install panels with a 3/8-inch (9.5-mm) gap where non-load-bearing construction abuts structural elements.
 - iv Install panels with a 1/4-inch (6.4-mm) gap where they abut masonry or similar materials that might retain moisture, to prevent wicking.
- b. Apply fasteners so heads bear tightly against face of sheathing, but do not cut into facing.
- c. Horizontal Installation: Install sheathing with V-grooved edge down and tongue edge up. Interlock tongue with groove to bring long edges in contact with edges of adjacent panels without forcing. Abut ends over centers of studs, and stagger end joints of adjacent panels not less than one stud spacing. Attach at perimeter and within field of panel to each stud.
 - i Space fasteners approximately 8 inches (200 mm) o.c. and set back a minimum of 3/8 inch (9.5 mm) from edges and ends of panels.

- ii For sheathing under stucco cladding, panels may be initially tacked in place with screws if overlying self-furring metal lath is screw-attached through sheathing to studs immediately after sheathing is installed.
- d. Vertical Installation: Install vertical edges centered over studs. Abut ends and edges with those of adjacent panels. Attach at perimeter and within field of panel to each stud.
 - i Space fasteners approximately 8 inches (200 mm) o.c. and set back a minimum of 3/8 inch (9.5 mm) from edges and ends of panels.
- e. Seal sheathing joints according to sheathing manufacturer's written instructions.
 - i Apply elastomeric sealant to joints and fasteners and trowel flat. Apply sufficient amount of sealant to completely cover joints and fasteners after troweling. Seal other penetrations and openings.
 - ii Apply glass-fiber sheathing tape to glass-mat gypsum sheathing joints and apply and trowel sealant to embed entire face of tape in sealant. Apply sealant to exposed fasteners with a trowel so fasteners are completely covered. Seal other penetrations and openings.
- f. Air-Barrier and Water-Resistant Glass-Mat Gypsum Sheathing:
 - i Install accessory materials according to sheathing manufacturer's written instructions and details to form a seal with adjacent construction, to seal fasteners, and ensure continuity of air and water barrier.
 - 1) Coordinate the installation of sheathing with installation of roofing membrane and base flashing to ensure continuity of air barrier with roofing membrane.
 - 2) Install transition strip on roofing membrane or base flashing, so that a minimum of 3 inches (75 mm) of coverage is achieved over each substrate.
 - ii Connect and seal sheathing material continuously to air barriers specified under other Sections as well as to roofing-membrane air barrier, concrete below-grade structures, floor-to-floor construction, exterior glazing and window systems, glazed curtain-wall systems, storefront systems, exterior louvers, exterior door framing, and other construction used in exterior wall openings, using accessory materials.
 - iii Apply joint sealants forming part of air-barrier assembly within manufacturer's recommended application temperature ranges. Consult manufacturer when sealant cannot be applied within these temperature ranges.
 - iv Wall Openings: Prime concealed, perimeter frame surfaces of windows, curtain walls, storefronts, and doors. Apply transition strip preformed silicone extrusion, so that a minimum of 3 inches (75 mm) of coverage is achieved over each substrate. Maintain 3 inches (75 mm) of full contact over firm bearing to perimeter frames, with not less than 1 inch (25 mm) of full contact.
 - 1) Transition Strip: Roll firmly to enhance adhesion.
 - 2) Preformed Silicone Extrusion: Set in full bed of silicone sealant applied to walls, frame, and air-barrier material.
 - v Fill gaps in perimeter frame surfaces of windows, curtain walls, storefronts, doors, and miscellaneous penetrations of sheathing material with foam sealant.
 - vi Seal strips and transition strips around masonry reinforcing or ties and penetrations with termination mastic.
 - vii Seal top of through-wall flashings to sheathing with an additional 6-inch- (150-mm-) wide, transition strip.
 - viii Seal exposed edges of strips at seams, cuts, penetrations, and terminations not concealed by metal counterflashings or ending in reglets with termination mastic.
 - ix Repair punctures, voids, and deficient lapped seams in strips and transition strips extending 6 inches (150 mm) beyond repaired areas in strip direction.

4. INSTALLATION OF CEMENTITIOUS BACKER UNITS
 - a. Install panels and treat joints according to ANSI A108.11 and manufacturer's written instructions for type of application indicated.
5. INSTALLATION OF FIBERBOARD SHEATHING
 - a. Comply with ASTM C846 and with manufacturer's written instructions.
 - b. Fasten fiberboard sheathing panels to intermediate supports and then at edges and ends. Use galvanized roofing nails or galvanized staples; comply with manufacturer's recommended spacing and referenced fastening schedule. Drive fasteners flush with surface of sheathing and locate perimeter fasteners at least 3/8 inch (9.5 mm) from edges and ends.
 - c. Install sheathing vertically with long edges parallel to, and centered over, studs. Install solid wood blocking where end joints do not occur over framing. Allow 1/8-inch (3-mm) open space between edges and ends of adjacent units. Stagger horizontal joints if any.
 - d. Cover sheathing as soon as practical after installation to prevent deterioration from wetting.
6. INSTALLATION OF FOAM-PLASTIC SHEATHING
 - a. Comply with manufacturer's written instructions.
 - b. Foam-Plastic Wall Sheathing: Install vapor-relief strips or equivalent for permitting escape of moisture vapor that otherwise would be trapped in stud cavity behind sheathing.
 - c. Apply sheathing tape to joints between foam-plastic sheathing panels and at items penetrating sheathing. Apply at upstanding flashing to overlap both flashing and sheathing.
7. INSTALLATION OF PARTICLEBOARD UNDERLAYMENT
 - a. Comply with CPA's recommendations for type of subfloor indicated. Fill and sand gouges, gaps, and chipped edges. Sand uneven joints flush.
 - i Fastening Method: Glue and nail underlayment to subflooring.
8. INSTALLATION OF HARDBOARD UNDERLAYMENT
 - a. Comply with CPA's recommendations and hardboard manufacturer's written instructions for preparing and applying hardboard underlayment.
 - i Fastening Method: Nail Nail or staple underlayment to subflooring.
9. FIELD QUALITY CONTROL
 - a. ABAA Quality Assurance Program: Perform examinations, preparation, installation, testing, and inspections under ABAA's Quality Assurance Program.
 - b. Testing and Inspecting Agency: Owner will engage Engage a qualified testing agency to perform tests and inspections.
 - c. Inspections: Air-barrier and water-resistant glass-mat gypsum sheathing, accessories, and installation are subject to inspection for compliance with requirements. Inspections may include the following:
 - i Continuity of air-barrier system has been achieved throughout the building envelope with no gaps or holes.
 - ii Laps in strips and transition strips have complied with minimum requirements and have been shingled in the correct direction (or mastic has been applied on exposed edges), with no fishmouths.
 - iii Termination mastic has been applied on cut edges.
 - iv Strips and transition strips have been firmly adhered to substrate.
 - v Compatible materials have been used.
 - vi Transitions at changes in direction and structural support at gaps have been provided.

- vii Connections between assemblies (sheathing and sealants) have complied with requirements for cleanliness, surface preparation and priming, structural support, integrity, and continuity of seal.
- viii All penetrations have been sealed.
- d. Tests: As determined by testing agency from among the following tests:
 - i Air-Leakage-Location Testing: Air-barrier sheathing assemblies will be tested for evidence of air leakage according to ASTM E1186, chamber pressurization or depressurization with smoke tracers ASTM E1186, chamber depressurization using detection liquids.
 - ii Air-Leakage-Volume Testing: Air-barrier assemblies will be tested for air-leakage rate according to ASTM E783 or ASTM E2357.
- e. Air barriers will be considered defective if they do not pass tests and inspections.
- f. Repair damage to air barriers caused by testing; follow manufacturer's written instructions.
- g. Prepare test and inspection reports.

D Measurement

The department will measure Rough Carpentry as a single unit for each project, acceptably completed.

E Payment

The department will pay for measured quantities at the contract unit price under the following bid item:

ITEM NUMBER	DESCRIPTION	UNIT
SPV.0060.24	Rough Carpentry	EACH

Payment is full compensation for completion of all rough carpentry. Furnish necessary materials, labor and all incidentals necessary to complete the work.

45. Metal Fabrications, Item SPV.0060.25.

A Description

A.1 SUMMARY

- a. Section Includes:
 - i Miscellaneous framing and supports including steel stair connection to structural steel.
 - ii Shelf angles.
 - iii Connection angles for curtain wall
 - iv Metal ship ladders and pipe crossovers (cleaning platform).
 - v Alternating tread devices.
 - vi Roof rail for glass curtain wall cleaning
 - vii Elevator pit sump covers.
 - viii Miscellaneous steel trim.
 - ix Metal bollards.
 - x Pipe and downspout guards.
 - xi Abrasive metal nosings, treads, and thresholds.
 - xii Loose bearing and leveling plates.
 - xiii Snow guards if not specified elsewhere

- b. Products furnished, but not installed, under this Section include the following:
 - i Loose steel lintels for masonry.
 - ii Steel weld plates and angles for casting into concrete for applications where they are not specified in other Sections.
 - iii Anchor bolts, steel pipe sleeves, slotted-channel inserts, and wedge-type inserts indicated to be cast into concrete or built into unit masonry.
- c. Related Requirements:
 - i "Unit Masonry" for installing loose lintels, anchor bolts, and other items built into unit masonry.
 - ii "Structural Steel Framing" for steel framing, supports, elevator machine beams, hoist beams, divider beams, door frames, and other steel items attached to the structural-steel framing.
 - iii "Roof Accessories"

A.2 COORDINATION

- a. Coordinate selection of shop primers with topcoats to be applied over them. Comply with paint and coating manufacturers' written instructions to ensure that shop primers and topcoats are compatible with one another.
- b. Coordinate installation of metal fabrications that are anchored to or that receive other work. Furnish setting drawings, templates, and directions for installing anchorages, including sleeves, concrete inserts, anchor bolts, and items with integral anchors, that are to be embedded in concrete or masonry. Deliver such items to Project site in time for installation.

A.3 ACTION SUBMITTALS

- a. Product Data: For the following:
 - i Nonslip aggregates and nonslip-aggregate surface finishes.
 - ii Fasteners.
 - iii Shop primers.
 - iv Shrinkage-resisting grout.
 - v Manufactured metal ladders.
 - vi Alternating tread devices.
 - vii Metal bollards.
 - viii Abrasive metal nosings, treads, and thresholds.
 - ix Snow guards if not specified elsewhere
- b. Shop Drawings: Show fabrication and installation details. Include plans, elevations, sections, and details of metal fabrications and their connections. Show anchorage and accessory items. Provide Shop Drawings for the following:
 - i Miscellaneous framing and supports for applications where framing and supports are not specified in other Sections.
 - ii Elevator machine beams, hoist beams, and divider beams.
 - iii Steel shapes for supporting elevator door sills.
 - iv Steel girders for supporting wood frame construction.
 - v Steel pipe columns for supporting wood frame construction.
 - vi Shelf angles.
 - vii Metal ladders.

- viii Alternating tread devices.
 - ix Metal floor plate and supports.
 - x Elevator pit sump covers.
 - xi Structural-steel door frames.
 - xii Miscellaneous steel trim including steel angle corner guards steel edgings and loading-dock edge angles.
 - xiii Metal bollards.
 - xiv Loose steel lintels.
 - xv Vehicular barrier cable systems.
- c. Samples for Verification: For each type and finish of extruded nosing and tread.
 - d. Delegated Design Submittals: For ladders alternating tread devices and, including analysis data signed and sealed by the qualified professional engineer responsible for their preparation.
 - e. Sustainable Design Submittals:

A.4 INFORMATIONAL SUBMITTALS

- a. Certificates:
 - i Mill Certificates: Signed by stainless steel manufacturers, certifying that products furnished comply with requirements.
 - ii Welding certificates.
 - iii Paint Compatibility Certificates: From manufacturers of topcoats applied over shop primers, certifying that shop primers are compatible with topcoats.
- b. Research Reports: For post-installed anchors.
- c. Delegated design engineer qualifications.

A.5 QUALITY ASSURANCE

- a. Welding Qualifications: Qualify procedures and personnel according to the following welding codes:
 - i AWS D1.1/D1.1M, "Structural Welding Code - Steel."
 - ii AWS D1.2/D1.2M, "Structural Welding Code - Aluminum."
 - iii AWS D1.6/D1.6M, "Structural Welding Code - Stainless Steel."

A.6 FIELD CONDITIONS

- a. Field Measurements: Verify actual locations of walls, floor slabs, decks, and other construction contiguous with metal fabrications by field measurements before fabrication.

B Materials

B.1 PERFORMANCE REQUIREMENTS

- a. Delegated Design: Engage a qualified professional engineer, as defined in Section "Quality Requirements," to design ladders alternating tread devices and vehicular barrier cable systems.
- b. Structural Performance of Aluminum Ladders: Ladders, including landings, are to withstand the effects of loads and stresses within limits and under conditions specified in ANSI/ASC A14.3.
- c. Structural Performance of Alternating Tread Devices: Alternating tread devices are to withstand the effects of gravity loads and the following loads and stresses within limits and under conditions indicated:

- i Uniform Load: 100 lbf/sq. ft. (4.79 kN/sq. m).
 - ii Concentrated Load: 300 lbf (1.33 kN) applied on an area of 4 sq. in. (2580 sq. mm).
 - iii Uniform and concentrated loads need not be assumed to act concurrently.
 - iv Alternating Tread Device Framing: Capable of withstanding stresses resulting from railing loads in addition to loads specified above.
 - v Comply with applicable railing loadings in Section "Pipe and Tube Railings."
- d. Thermal Movements: Allow for thermal movements from ambient and surface temperature changes.
- i Temperature Change: 120 deg F (67 deg C), ambient; 180 deg F (100 deg C), material surfaces.

B.2 METALS

- a. Metal Surfaces, General: Provide materials with smooth, flat surfaces unless otherwise indicated. For metal fabrications exposed to view in the completed Work, provide materials without seam marks, roller marks, rolled trade names, or blemishes.
- b. Steel Plates, Shapes, and Bars: ASTM A36/A36M.
- c. Stainless Steel Sheet, Strip, and Plate: ASTM A240/A240M or ASTM A666, Type 304 Type 316L.
- d. Stainless Steel Bars and Shapes: ASTM A276/A276M, Type 304 Type 316L.
- e. Rolled-Steel Floor Plate: ASTM A786/A786M, rolled from plate complying with ASTM A36/A36M or ASTM A283/A283M, Grade C or D.
- f. Rolled-Stainless Steel Floor Plate: ASTM A793.
- g. Abrasive-Surface Floor Plate: Steel plate with abrasive granules rolled into surface or with abrasive material metallurgically bonded to steel.
 - i Source Limitations: Obtain floor plate from single source from single manufacturer.
- h. Steel Tubing: ASTM A500/A500M, cold-formed steel tubing.
- i. Steel Pipe: ASTM A53/A53M, Standard Weight (Schedule 40) unless otherwise indicated.
- j. Zinc-Coated Steel Wire Rope: ASTM A741.
 - i Wire Rope Fittings: Hot-dip galvanized-steel connectors with capability to sustain, without failure, a load equal to minimum breaking strength of wire rope with which they are used.
- k. Stainless Steel Wire Rope: Wire rope manufactured from stainless steel wire complying with ASTM A492, Type 316.
 - i Wire Rope Fittings: Stainless steel connectors, Type 316, with capability to sustain, without failure, a load equal to minimum breaking strength of wire rope with which they are used.
- l. Steel Prestressing Strand: ASTM A416/A416M, Grade 270 (Grade 1860), low-relaxation, seven-wire, with 0.9-lb/sq. ft. (4.39-kg/sq. m) zinc coating.
 - i Steel Prestressing Strand Fittings: Hot-dip galvanized-steel anchors and connectors with capability to sustain, without failure, a load equal to minimum breaking strength of steel prestressing strand with which they are used.
- m. Slotted Channel Framing: Cold-formed metal box channels (struts) complying with MFMA-4.
 - i Size of Channels: 1-5/8 by 1-5/8 inches (41 by 41 mm) As indicated.
 - ii Galvanized Steel: ASTM A653/A653M, commercial steel, Type B structural steel, Grade 33 (Grade 230), with G90 (Z275) coating; 0.108-inch (2.8-mm) 0.079-inch (2-mm) 0.064-inch (1.6-mm) nominal thickness.

- iii Cold-Rolled Steel: ASTM A1008/A1008M, commercial steel, Type B structural steel, Grade 33 (Grade 230); 0.0966-inch (2.5-mm) 0.0677-inch (1.7-mm) 0.0528-inch (1.35-mm) minimum thickness; unfinished coated with rust-inhibitive, baked-on, acrylic enamel hot-dip galvanized after fabrication.
- n. Aluminum Plate and Sheet: ASTM B209 (ASTM B209M), Alloy 6061-T6.
- o. Aluminum Extrusions: ASTM B221 (ASTM B221M), Alloy 6063-T6.
- p. Aluminum-Alloy Rolled Tread Plate: ASTM B632/B632M, Alloy 6061-T6.
- q. Aluminum Castings: ASTM B26/B26M, Alloy 443.0-F.

B.3 FASTENERS

- a. General: Unless otherwise indicated, provide Type 304 Type 316 stainless steel fasteners for exterior use and zinc-plated fasteners with coating complying with ASTM B633 or ASTM F1941/F1941M, Class Fe/Zn 5, at exterior walls. Select fasteners for type, grade, and class required.
 - i Provide stainless steel fasteners for fastening aluminum stainless steel
- b. Steel Bolts and Nuts: Regular hexagon-head bolts, ASTM A307, Grade A (ISO 898-1, Property Class 4.6); with hex nuts, ASTM A563 (ASTM A563M); and, where indicated, flat washers.
- c. High-Strength Bolts, Nuts, and Washers: ASTM F3125/F3125M, Grade A325 (Grade A325M), Type 3, heavy-hex steel structural bolts; ASTM A563, Grade DH3, (ASTM A563M, Class 10S3) heavy-hex carbon-steel nuts; and where indicated, flat washers.
- d. Stainless Steel Bolts and Nuts: Regular hexagon-head annealed stainless steel bolts, ASTM F593 (ISO 3506-1); with hex nuts, ASTM F594 (ASTM F836M); and, where indicated, flat washers; Alloy Group 1 (A1) Group 2 (A4).
- e. Anchor Bolts: ASTM F1554, Grade 36, of dimensions indicated; with nuts, ASTM A563 (ASTM A563M); and, where indicated, flat washers.
 - i Hot-dip galvanize or provide mechanically deposited, zinc coating where item being fastened is indicated to be galvanized.
- f. Anchors, General: Capable of sustaining, without failure, a load equal to six times the load imposed when installed in unit masonry and four times the load imposed when installed in concrete, as determined by testing according to ASTM E488/E488M, conducted by a qualified independent testing agency.
- g. Cast-in-Place Anchors in Concrete: Either threaded or wedge type unless otherwise indicated; galvanized ferrous castings, either ASTM A47/A47M malleable iron or ASTM A27/A27M cast steel. Provide bolts, washers, and shims as needed, all hot-dip galvanized per ASTM F2329/F2329M.
- h. Post-Installed Anchors: Torque-controlled expansion anchors or chemical anchors.
 - i Material for Interior Locations: Carbon-steel components zinc plated to comply with ASTM B633 or ASTM F1941/F1941M, Class Fe/Zn 5, unless otherwise indicated.
 - ii Material for Exterior Locations and Where Stainless Steel Is Indicated: Alloy Group 1 (A1) Group 2 (A4) stainless steel bolts, ASTM F593 (ISO 3506-1), and nuts, ASTM F594 (ASTM F836M).
- i. Slotted-Channel Inserts: Cold-formed, hot-dip galvanized-steel box channels (struts) complying with MFMA-4, 1-5/8 by 7/8 inches (41 by 22 mm) by length indicated with anchor straps or studs not less than 3 inches (75 mm) long at not more than 8 inches (200 mm) o.c. Provide with temporary filler and tee-head bolts, complete with washers and nuts, all zinc-plated to comply with ASTM B633, Class Fe/Zn 5, as needed for fastening to inserts.

B.4 MISCELLANEOUS MATERIALS

- a. Shop Primers: Provide primers that comply with Section "Exterior Painting." Section "Interior Painting."
- b. Universal Shop Primer: Fast-curing, lead- and chromate-free, universal modified-alkyd primer complying with MPI#79 and compatible with topcoat.
 - i Use primer containing pigments that make it easily distinguishable from zinc-rich primer.
- c. Water-Based Primer: Emulsion type, anticorrosive primer for mildly corrosive environments that is resistant to flash rusting when applied to cleaned steel, complying with MPI#107 and compatible with topcoat.
- d. Epoxy Zinc-Rich Primer: Complying with MPI#20 and compatible with topcoat.
- e. Shop Primer for Galvanized Steel: Primer formulated for exterior use over zinc-coated metal and compatible with finish paint systems indicated.
- f. Galvanizing Repair Paint: High-zinc-dust-content paint complying with SSPC-Paint 20 and compatible with paints specified to be used over it.
- g. Bituminous Paint: Cold-applied asphalt emulsion complying with ASTM D1187/D1187M.
- h. Shrinkage-Resistant Grout: Factory-packaged, non-metallic, non-staining, non-corrosive, nongaseous grout complying with ASTM C1107/C1107M. Provide grout specifically recommended by manufacturer for interior and exterior applications.
- i. Concrete: Comply with requirements in Section "Cast-in-Place Concrete" for normal-weight, air-entrained concrete with a minimum 28-day compressive strength of min 4000 psi.
- j. Shop Assembly: Preassemble items in the shop to greatest extent possible. Disassemble units only as necessary for shipping and handling limitations. Use connections that maintain structural value of joined pieces. Clearly mark units for reassembly and coordinated installation.
- k. Cut, drill, and punch metals cleanly and accurately. Remove burrs and ease edges to a radius of approximately 1/32 inch (1 mm) unless otherwise indicated. Remove sharp or rough areas on exposed surfaces.
- l. Form bent-metal corners to smallest radius possible without causing grain separation or otherwise impairing work.
- m. Form exposed work with accurate angles and surfaces and straight edges.
- n. Weld corners and seams continuously to comply with the following:
 - i Use materials and methods that minimize distortion and develop strength and corrosion resistance of base metals.
 - ii Obtain fusion without undercut or overlap.
 - iii Remove welding flux immediately.
 - iv At exposed connections, finish exposed welds and surfaces smooth and blended so no roughness shows after finishing and contour of welded surface matches that of adjacent surface.
- o. Form exposed connections with hairline joints, flush and smooth, using concealed fasteners or welds where possible. Where exposed fasteners are required, use Phillips flat-head (countersunk) fasteners unless otherwise indicated. Locate joints where least conspicuous.
- p. Fabricate seams and other connections that are exposed to weather in a manner to exclude water. Provide weep holes where water may accumulate.
- q. Cut, reinforce, drill, and tap metal fabrications as indicated to receive finish hardware, screws, and similar items.

- r. Provide for anchorage of type indicated; coordinate with supporting structure. Space anchoring devices to secure metal fabrications rigidly in place and to support indicated loads.
- s. Where units are indicated to be cast into concrete or built into masonry, equip with integrally welded steel strap anchors, 1/8 by 1-1/2 inches (3.2 by 38 mm), with a minimum 6-inch (150-mm) embedment and 2-inch (50-mm) hook, not less than 8 inches (200 mm) from ends and corners of units and 24 inches (600 mm) o.c., unless otherwise indicated.

B.5 MISCELLANEOUS FRAMING AND SUPPORTS

- a. General: Provide steel framing and supports not specified in other Sections as needed to complete the Work.
- b. Fabricate units from steel shapes, plates, and bars of welded construction unless otherwise indicated. Fabricate to sizes, shapes, and profiles indicated and as necessary to receive adjacent construction.
 - i Fabricate units from slotted channel framing where indicated.
 - ii Furnish inserts for units installed after concrete is placed.
- c. Galvanize miscellaneous framing and supports where indicated.

B.6 SHELF ANGLES

- a. Fabricate shelf angles from steel angles of sizes indicated and for attachment to concrete framing. Provide horizontally slotted holes to receive 3/4-inch (19-mm) bolts, spaced not more than 6 inches (150 mm) from ends and 24 inches (600 mm) o.c., unless otherwise indicated.
 - i Provide mitered and welded units at corners.
 - ii Provide open joints in shelf angles at expansion and control joints. Make open joint approximately 2 inches (50 mm) larger than expansion or control joint.
- b. For cavity walls, provide vertical channel brackets to support angles from backup masonry and concrete.
- c. Galvanize and prime shelf angles located in exterior walls.
- d. Furnish wedge-type concrete inserts, complete with fasteners, to attach shelf angles to cast-in-place concrete.

B.7 METAL LADDERS

- a. General:
 - i Comply with ANSI A14.3, except for elevator pit ladders.
 - ii For elevator pit ladders, comply with ASME A17.1/CSA B44.
- b. Steel Ladders:
 - i 18 inches (457 mm) apart unless otherwise indicated.
 - ii Siderails: Continuous, 3/8-by-2-1/2-inch (9.5-by-64-mm) 1/2-by-2-1/2-inch (12.7-by-64-mm) steel flat bars, with eased edges.
 - iii Rungs: 3/4-inch- (19-mm-) diameter 3/4-inch- (19-mm-) square 1-inch- (25-mm-) diameter 1-inch- (25-mm-) square, steel bars.
 - iv Fit rungs in centerline of siderails; plug-weld and grind smooth on outer rail faces.
 - v Provide nonslip surfaces on top of each rung, either by coating rung with aluminum-oxide granules set in epoxy-resin adhesive or by using a type of manufactured rung filled with aluminum-oxide grout.
 - vi Provide nonslip surfaces on top of each rung by coating with abrasive material metallically bonded to rung.

- vii Source Limitations: Obtain nonslip surfaces from single source from single manufacturer.
 - viii Provide platforms as indicated fabricated from welded or pressure-locked steel bar grating, supported by steel angles. Limit openings in gratings to no more than ½ inch (12 mm) ¾ inch (19 mm) in least dimension.
 - ix Support each ladder at top and bottom and not more than 60 inches (1500 mm) o.c. with welded or bolted steel brackets.
 - x Galvanize and prime exterior ladders, including brackets.
 - xi Prime exterior ladders, including brackets and fasteners, with zinc-rich primer.
- c. Aluminum Ladders:
- i Source Limitations: Obtain aluminum ladders from single source from single manufacturer.
 - ii Space siderails 16 inches (406 mm) 18 inches (457 mm) apart unless otherwise indicated.
 - iii Siderails: Continuous extruded-aluminum channels or tubes, not less than 2-1/2 inches (64 mm) deep, ¾ inch (19 mm) wide, and 1/8 inch (3.2 mm) thick.
 - iv Rungs: Extruded-aluminum tubes, not less than ¾ inch (19 mm) deep and not less than 1/8 inch (3.2 mm) thick, with ribbed tread surfaces.
 - v Fit rungs in centerline of siderails; fasten by welding or with stainless steel fasteners or brackets and aluminum rivets.
 - vi Provide platforms as indicated fabricated from pressure-locked aluminum bar grating or extruded-aluminum plank grating, supported by extruded-aluminum framing. Limit openings in gratings to no more than 1/2 inch (12 mm) ¾ inch (19 mm) in least dimension.
 - vii Support each ladder at top and bottom and not more than 60 inches (1500 mm) o.c. with welded or bolted aluminum brackets.
 - viii Provide minimum 72-inch- (1830-mm-) high, hinged security door with padlock hasp at foot of ladder to prevent unauthorized ladder use.

B.8 ALTERNATING TREAD DEVICES

- a. Alternating Tread Devices: Fabricate alternating tread devices of open-type construction with channel or plate stringers and pipe and tube railings unless otherwise indicated. Provide brackets and fittings for installation.
 - i Tread depth is not to be less than 5 inches (127 mm) exclusive of nosing or less than 8-1/2 inches (216 mm), including the nosing, tread width is not to be less than 7 inches (178 mm), and riser height is not to be more than 9-1/2 inches (241 mm).
 - ii Tread depth is not to be less than 8-1/2 inches (216 mm) exclusive of nosing or less than 10-1/2 inches (267 mm), including the nosing, tread width is not to be less than 7 inches (178 mm), and riser height is not to be more than 8 inches (203 mm).
 - iii Fabricate from steel stainless steel aluminum and assemble by welding or with stainless steel fasteners.
 - iv Comply with applicable railing requirements in Section "Pipe and Tube Railings."
- b. Galvanize and prime exterior steel alternating tread devices, including treads, railings, brackets, and fasteners.
- c. Prime exterior steel alternating tread devices, including treads, railings, brackets, and fasteners, with zinc-rich primer.

B.9 METAL SHIPS' LADDERS AND PIPE CROSSOVERS

- a. Provide metal ships' ladders and pipe crossovers where indicated. Fabricate of open-type construction with channel or plate stringers and pipe and tube railings unless otherwise indicated. Provide brackets and fittings for installation.
 - i Treads are not to be less than 5 inches (127 mm) exclusive of nosing or less than 8-1/2 inches (216 mm) including the nosing, and riser height is not to be more than 9-1/2 inches (241 mm).
 - ii Fabricate ships' ladders and pipe crossovers, including railings from steel stainless steel aluminum.
 - iii Fabricate treads and platforms from welded or pressure-locked steel bar pressure-locked stainless steel bar pressure-locked aluminum bar extruded-aluminum plank grating. Limit openings in gratings to no more than 1/2 inch (12 mm) 3/4 inch (19 mm) in least dimension.
 - iv Fabricate treads and platforms from rolled-steel floor rolled-stainless steel floor rolled-aluminum-alloy tread abrasive-surface floor plate.
 - v Comply with applicable railing requirements in Section "Pipe and Tube Railings."
- b. Galvanize and prime exterior steel ships' ladders and pipe crossovers, including treads, railings, brackets, and fasteners.
- c. Prime exterior steel ships' ladders and pipe crossovers, including treads, railings, brackets, and fasteners, with zinc-rich primer.

B.10 METAL FLOOR PLATE

- a. Fabricate from rolled-aluminum-alloy tread abrasive-surface floor plate of thickness indicated below:
 - i Thickness: 1/8 inch (3.2 mm) 3/16 inch (4.8 mm) 1/4 inch (6.4 mm) 5/16 inch (8 mm) 3/8 inch (9.5 mm) As indicated.
- b. Provide grating sections where indicated, fabricated from welded or pressure-locked steel bar pressure-locked stainless steel bar pressure-locked aluminum bar extruded-aluminum plank grating. Limit openings in gratings to no more than 1/2 inch (12 mm) 3/4 inch (19 mm) 1 inch (25 mm) in least dimension.
- c. Provide steel stainless steel aluminum angle supports as indicated.
- d. Include steel stainless steel aluminum angle stiffeners, and fixed and removable sections as indicated.
- e. Provide flush steel stainless steel aluminum bar drop handles for lifting removable sections, one at each end of each section.

B.11 ELEVATOR PIT SUMP COVERS

- a. Fabricate from 1/8-inch (3.2-mm) 3/16-inch (4.8-mm) rolled-steel abrasive-surface floor plate with four 1-inch- (25-mm-) diameter holes for water drainage and for lifting.
- b. Fabricate from welded or pressure-locked steel bar grating. Limit openings in gratings to no more than 1/2 inch (12 mm) 3/4 inch (19 mm) 1 inch (25 mm) in least dimension.
- c. Provide steel angle supports unless otherwise indicated.

B.12 MISCELLANEOUS STEEL TRIM

- a. Unless otherwise indicated, fabricate units from steel shapes, plates, and bars of profiles shown with continuously welded joints and smooth exposed edges. Miter corners and use concealed field splices where possible.

- b. Provide cutouts, fittings, and anchorages as needed to coordinate assembly and installation with other work.
 - i. Provide with integrally welded steel strap anchors for embedding in concrete or masonry construction.
- c. Galvanize and prime exterior miscellaneous steel trim.
- d. Prime exterior miscellaneous steel trim with zinc-rich primer.

B.13 METAL BOLLARDS

- a. Fabricate metal bollards from Schedule 80 steel pipe Schedule 40 steel pipe Schedule 80 stainless steel, No. 4/180-grit finish 1/4-inch (6.4-mm) wall-thickness rectangular steel tubing steel shapes, as indicated.
 - i. Cap bollards with 1/4-inch- (6.4-mm-) thick, steel stainless steel, ASTM A480/A480M, No. 4 finish plate with flat sloped domed top.
 - ii. Where bollards are indicated to receive controls for door operators, provide cutouts for controls and holes for wire.
 - iii. Where bollards are indicated to receive light fixtures, provide cutouts for fixtures and holes for wire.
- b. Fabricate bollards with 3/8-inch- (9.5-mm-) thick, steel stainless steel, ASTM A480/A480M, No. 4 finish baseplates for bolting to concrete slab. Drill baseplates at all four corners for 3/4-inch (19-mm) anchor bolts.
 - i. Where bollards are to be anchored to sloping concrete slabs, angle baseplates for plumb alignment of bollards.
- c. Fabricate sleeves for bollard anchorage from steel or stainless steel pipe or tubing with 1/4-inch- (6.4-mm-) thick, steel or stainless steel plate welded to bottom of sleeve. Make sleeves not less than 8 inches (200 mm) deep and 3/4 inch (19 mm) larger than OD of bollard.
- d. Fabricate internal sleeves for removable bollards from Schedule 80 steel stainless steel pipe or 1/4-inch (6.4-mm) wall-thickness steel stainless steel tubing with an OD approximately 1/16 inch (1.5 mm) less than ID of bollards. Match drill sleeve and bollard for 3/4-inch (19-mm) steel stainless steel machine bolt.
- e. Prime steel bollards with zinc-rich primer.

B.14 ABRASIVE METAL NOSINGS; TREADS; AND THRESHOLDS

- a. Cast-Metal Units: Cast iron aluminum bronze (leaded red or semired brass) nickel silver (leaded nickel bronze), with an integral-abrasive, as-cast finish consisting of aluminum oxide, silicon carbide, or a combination of both. Fabricate units in lengths necessary to accurately fit openings or conditions.
 - i. Source Limitations: Obtain units from single source from single manufacturer.
 - ii. Cross-hatched nosings, 4 inches (100 mm) wide, with 1/4-inch- (6-mm-) thick 1-inch (25-mm) lip, for casting into concrete.
 - iii. Cross-hatched nosings, 1-1/2 inches (38-mm) wide, 3/8-inch- (9.5-mm-) thick 1-1/2 inch (38-mm) lip, for casting into concrete.
- b. Extruded Units: Aluminum with abrasive filler consisting of aluminum oxide, silicon carbide, or a combination of both, in an epoxy-resin binder. Fabricate units in lengths necessary to accurately fit openings or conditions.
 - i. Source Limitations: Obtain units from single source from single manufacturer.
- c. Provide ribbed units, with abrasive filler strips projecting 1/16 inch (1.5 mm) above aluminum extrusion.
- d. Provide solid-abrasive-type units without ribs.

- e. Nosings:
 - i Square-back units, 1-7/8 inches (48 mm) 3 inches (75 mm) 4 inches (100 mm) wide, for casting into concrete steps.
 - ii Beveled-back units, 3 inches (75 mm) 4 inches (100 mm) wide with 1-3/8-inch (35-mm) lip, for surface mounting on existing stairs.
 - iii Two-piece units, 3 inches (75 mm) wide, with subchannel for casting into concrete steps.
- f. Provide anchors for embedding units in concrete, either integral or applied to units, as standard with manufacturer.
- g. Drill for mechanical anchors and countersink. Locate holes not more than 4 inches (100 mm) from ends and not more than 12 inches (300 mm) o.c., evenly spaced between ends, unless otherwise indicated. Provide closer spacing if recommended by manufacturer.
 - i Provide two rows of holes for units more than 5 inches (125 mm) wide, with two holes aligned at ends and intermediate holes staggered.
- h. Apply bituminous paint to concealed surfaces of cast-metal units.
- i. Apply clear lacquer to concealed surfaces of extruded units.

B.15 METAL DOWNSPOUT BOOTS

- a. Source Limitations: Obtain downspout boots from single source from single manufacturer.
- b. Provide downspout boots made from cast iron aluminum in heights indicated with inlets of size and shape to suit downspouts. Provide units with flanges and holes for countersunk anchor bolts.
 - i Outlet: Vertical, to discharge into pipe Horizontal, to discharge into pipe At 35 degrees from horizontal, to discharge onto splash block or pavement.
- c. Prime cast-iron downspout boots with zinc-rich primer.

B.16 LOOSE BEARING AND LEVELING PLATES

- a. Provide loose bearing and leveling plates for steel items bearing on masonry or concrete construction. Drill plates to receive anchor bolts and for grouting.
- b. Galvanize bearing and leveling plates.
- c. Prime plates with zinc-rich primer.

B.17 LOOSE STEEL LINTELS

- a. Fabricate loose steel lintels from steel angles and shapes of size indicated for openings and recesses in masonry walls and partitions at locations indicated. Fabricate in single lengths for each opening unless otherwise indicated. Weld adjoining members together to form a single unit where indicated.
- b. Size loose lintels to provide bearing length at each side of openings equal to one-twelfth of clear span, but not less than 8 inches (200 mm) unless otherwise indicated.
- c. Galvanize and prime loose steel lintels located in exterior walls.
- d. Prime loose steel lintels located in exterior walls with zinc-rich primer.

B.18 STEEL WELD PLATES AND ANGLES

- a. Provide steel weld plates and angles not specified in other Sections, for items supported from concrete construction as needed to complete the Work. Provide each unit with no fewer than two integrally welded steel strap anchors for embedding in concrete.

B.19 GENERAL FINISH REQUIREMENTS

- a. Finish metal fabrications after assembly.
- b. Finish exposed surfaces to remove tool and die marks and stretch lines, and to blend into surrounding surface.

B.20 STEEL AND IRON FINISHES

- a. Galvanizing: Hot-dip galvanize items as indicated to comply with ASTM A153/A153M for steel and iron hardware and with ASTM A123/A123M for other steel and iron products.
 - i Do not quench or apply post galvanizing treatments that might interfere with paint adhesion.
- b. Preparation for Shop Priming Galvanized Items: After galvanizing, thoroughly clean galvanized surfaces of grease, dirt, oil, flux, and other foreign matter, and treat with metallic phosphate process.
- c. Shop prime iron and steel items not indicated to be galvanized unless they are to be embedded in concrete, sprayed-on fireproofing, or masonry, or unless otherwise indicated.
 - i Shop prime with universal shop primer primers specified in Section "Exterior Painting" primers specified in Section "Interior Painting" unless zinc-rich primer.
- d. Preparation for Shop Priming: Prepare surfaces to comply with SSPC-SP 6/NACE No. 3, "Commercial Blast Cleaning." SSPC-SP 3, "Power Tool Cleaning." requirements indicated below:
 - i Exterior Items: SSPC-SP 6/NACE No. 3, "Commercial Blast Cleaning."
 - ii Items Indicated to Receive Zinc-Rich Primer: SSPC-SP 6/NACE No. 3, "Commercial Blast Cleaning."
 - iii Other Steel Items: SSPC-SP 3, "Power Tool Cleaning."
 - iv Galvanized-Steel Items: SSPC-SP 16, "Brush-off Blast Cleaning of Coated and Uncoated Galvanized Steel, Stainless Steels, and Non-Ferrous Metals."
- e. Shop Priming: Apply shop primer to comply with SSPC-PA 1, "Paint Application Specification No. 1: Shop, Field, and Maintenance Painting of Steel," for shop painting.
 - i Stripe paint corners, crevices, bolts, welds, and sharp edges.

B.21 ALUMINUM FINISHES

- a. Confirm final finish with Architect. For Clear Anodic Finish: AAMA 611, Class I, AA-M12C22A41.

C Construction

C.1 INSTALLATION, GENERAL

- a. Cutting, Fitting, and Placement: Perform cutting, drilling, and fitting required for installing metal fabrications. Set metal fabrications accurately in location, alignment, and elevation; with edges and surfaces level, plumb, true, and free of rack; and measured from established lines and levels.
- b. Fit exposed connections accurately together to form hairline joints. Weld connections that are not to be left as exposed joints but cannot be shop welded because of shipping size limitations. Do not weld, cut, or abrade surfaces of exterior units that have been hot-dip galvanized after fabrication and are for bolted or screwed field connections.
- c. Field Welding: Comply with the following requirements:
 - i Use materials and methods that minimize distortion and develop strength and corrosion resistance of base metals.
 - ii Obtain fusion without undercut or overlap.

- iii Remove welding flux immediately.
- iv At exposed connections, finish exposed welds and surfaces smooth and blended so no roughness shows after finishing and contour of welded surface matches that of adjacent surface.
- d. Fastening to In-Place Construction: Provide anchorage devices and fasteners where metal fabrications are required to be fastened to in-place construction. Provide threaded fasteners for use with concrete and masonry inserts, toggle bolts, through bolts, lag screws, wood screws, and other connectors.
- e. Provide temporary bracing or anchors in formwork for items that are to be built into concrete, masonry, or similar construction.
- f. Corrosion Protection: Coat concealed surfaces of aluminum that come into contact with grout, concrete, masonry, wood, or dissimilar metals with the following:
 - i Cast Aluminum: Heavy coat of bituminous paint.
 - ii Extruded Aluminum: Two coats of clear lacquer.

C.2 INSTALLATION OF MISCELLANEOUS FRAMING AND SUPPORTS

- a. General: Install framing and supports to comply with requirements of items being supported, including manufacturers' written instructions and requirements indicated on Shop Drawings.
- b. Anchor shelf angles securely to existing construction with expansion anchors anchor bolts through bolts.
- c. Support steel girders on solid grouted masonry, concrete, or steel pipe columns. Secure girders with anchor bolts embedded in grouted masonry or concrete or with bolts through top plates of pipe columns.
 - i Where grout space under bearing plates is indicated for girders supported on concrete or masonry, install as specified in "Installing Bearing and Leveling Plates" Article.
- d. Install pipe columns on concrete footings with grouted baseplates. Position and grout column baseplates as specified in "Installation of Bearing and Leveling Plates" Article.
 - i Grout baseplates of columns supporting steel girders after girders are installed and leveled.

C.3 INSTALLATION OF SHELF ANGLES

- a. Install shelf angles as required to keep masonry level, at correct elevation, and flush with vertical plane.

C.4 INSTALLATION OF METAL LADDERS

- a. Secure ladders to adjacent construction with the clip angles attached to the stringer.
- b. Install brackets as required for securing of ladders welded or bolted to structural steel or built into masonry or concrete.

C.5 INSTALLATION OF ALTERNATING TREAD DEVICES

- a. Secure top and bottom of alternating tread devices to construction to comply with manufacturer's written instructions.

C.6 INSTALLATION OF METAL SHIPS' LADDERS AND PIPE CROSSOVERS

- a. Secure top and bottom of ships' ladders to construction to comply with manufacturer's written instructions.
- b. Secure pipe crossovers to construction to comply with manufacturer's written instructions.

C.7 INSTALLATION OF METAL FLOOR PLATE

- a. Install metal floor plates flush with finished surface. Adjust as required to avoid lippage that could present a tripping hazard.

C.8 INSTALLATION OF ELEVATOR PIT SUMP COVERS

- a. Install tops of elevator sump pit cover plates and frames flush with finished surface. Adjust as required to avoid lippage that could present a tripping hazard.

C.9 INSTALLATION OF STRUCTURAL-STEEL DOOR FRAMES

- a. Fasten structural steel door frames to the floor slab by means of angle clips and expansion bolts. Anchor door jambs to adjacent construction according to shop drawing details.

C.10 INSTALLATION OF MISCELLANEOUS STEEL TRIM

- a. Anchor to concrete construction to comply with manufacturer's written instructions.

C.11 INSTALLATION OF METAL BOLLARDS

- a. Fill metal-capped bollards solidly with concrete and allow concrete to cure seven days before installing.
 - i Do not fill removable bollards with concrete.
- b. Anchor bollards to existing construction with expansion anchors anchor bolts through bolts. Provide four 3/4-inch (19-mm) bolts at each bollard unless otherwise indicated.
 - i Embed anchor bolts at least 4 inches (100 mm) in concrete.
- c. Anchor bollards in concrete with pipe sleeves preset and anchored into concrete in formed or core-drilled holes not less than 42 inches (1050 mm) deep and 3/4 inch (19 mm) larger than OD of bollard. Fill annular space around bollard solidly with shrinkage-resistant grout; mixed and placed to comply with grout manufacturer's written instructions. Slope grout up approximately 1/8 inch (3 mm) toward bollard.
- d. Anchor bollards in place with concrete footings. Center and align bollards in holes 3 inches (75 mm) above bottom of excavation. Place concrete and vibrate or tamp for consolidation. Support and brace bollards in position until concrete has cured.
- e. Anchor internal sleeves for removable bollards in concrete by inserting in pipe sleeves preset into concrete formed or core-drilled holes not less than 42 inches (1050 mm) deep and 3/4 inch (19 mm) larger than OD of sleeve. Fill annular space around internal sleeves solidly with shrinkage-resistant grout; mixed and placed to comply with grout manufacturer's written instructions. Slope grout up approximately 1/8 inch (3 mm) toward internal sleeve.
- f. Anchor internal sleeves for removable bollards in place with concrete footings. Center and align sleeves in holes 3 inches (75 mm) above bottom of excavation. Place concrete and vibrate or tamp for consolidation. Support and brace sleeves in position until concrete has cured.
- g. Place removable bollards over internal sleeves and secure with 3/4-inch (19-mm) machine bolts and nuts. After tightening nuts, drill holes in bolts for inserting padlocks. Owner furnishes padlocks.
- h. Fill bollards solidly with concrete, mounding top surface to shed water.
 - i Do not fill removable bollards with concrete.

C.12 INSTALLATION OF ABRASIVE METAL NOSINGS, TREADS, AND THRESHOLDS

- a. Center nosings on tread widths unless otherwise indicated.
- b. For nosings embedded in concrete steps or curbs, align nosings flush with riser faces and level with tread surfaces.
- c. Seal thresholds exposed to exterior with elastomeric sealant complying with Section "Joint Sealants" to provide a watertight installation.

C.13 INSTALLATION OF METAL DOWNSPOUT BOOTS

- a. Anchor metal downspout boots to concrete or masonry construction to comply with manufacturer's written instructions.
- b. Secure downspouts terminations to downspouts and substrate per manufacturer's instructions.

C.14 INSTALLATION OF LOOSE BEARING AND LEVELING PLATES

- a. Clean concrete and masonry bearing surfaces of bond-reducing materials and roughen to improve bond to surfaces. Clean bottom surface of plates.
- b. Set bearing and leveling plates on wedges, shims, or leveling nuts. After bearing members have been positioned and plumbed, tighten anchor bolts. Do not remove wedges or shims but, if protruding, cut off flush with edge of bearing plate before packing with shrinkage-resistant grout. Pack grout solidly between bearing surfaces and plates to ensure that no voids remain.

C.15 REPAIRS

- a. Touchup Painting:
 - i Immediately after erection, clean field welds, bolted connections, and abraded areas. Paint uncoated and abraded areas with same material as used for shop painting to comply with SSPC-PA 1 for touching up shop-painted surfaces.
 - 1) Apply by brush or spray to provide a minimum 2.0-mil (0.05-mm) dry film thickness.
 - ii Cleaning and touchup painting of field welds, bolted connections, and abraded areas of shop paint are specified in "Exterior Painting." "Interior Painting."
- b. Galvanized Surfaces: Clean field welds, bolted connections, and abraded areas and repair galvanizing to comply with ASTM A780/A780M.

D Measurement

The department will measure Metal Fabrications as a single unit for each project, acceptably completed.

E Payment

The department will pay for measured quantities at the contract unit price under the following bid item:

ITEM NUMBER	DESCRIPTION	UNIT
SPV.0060.25	Metal Fabrications	EACH

Payment is full compensation for furnishing and installation of all metal fabrications in the project.

46. Gypsum Board Partitions and Assemblies, Item SPV.0060.26.

A Description

- 1. Interior gypsum board.
- 2. Gypsum board shaft wall assemblies
- 3. Non-structural metal framing
- 4. Thermal insulation

A.2 Gypsum Board Partitions

- 1. Section Includes:
 - a. Interior gypsum board.

2. Related Requirements:
 - a. "Sheathing" for gypsum sheathing for exterior walls.
 - b. "Gypsum Board Shaft Wall Assemblies" for metal shaft-wall framing, gypsum shaft liners, and other components of shaft-wall assemblies.
 - c. "Non-Structural Metal Framing" for non-structural steel framing and suspension systems that support gypsum board panels.
 - d. "Ceramic Tiling" for cementitious backer units installed as substrates for ceramic tile.
3. Action Submittals
 - a. Product Data: For the following:
 - i Gypsum wallboard.
 - ii Gypsum board, Type X.
 - iii Gypsum ceiling board.
 - iv Mold-resistant gypsum board.
 - v Glass-mat interior gypsum board.
 - vi Cementitious backer units.
 - vii Interior trim.
 - viii Exterior trim.
 - ix Aluminum trim.
 - x Joint treatment materials.
 - xi Laminating adhesive.
 - xii Sound-attenuation blankets.
 - xiii Acoustical sealant.
 - xiv Textured finishes.
 - b. Shop Drawings: Show locations and installation of control and expansion joints, including plans, elevations, sections, details of components, and attachments to other work.
 - c. Samples: For the following products:
 - i Trim Accessories: Full-size Sample in 12-inch- (300-mm-) long length for each trim accessory indicated.
 - ii Textured Finishes: Manufacturer's standard size for each textured finish indicated and on same backing indicated for Work.
 - d. Samples for Initial Selection: For each type of trim accessory and textured finish indicated.
 - e. Samples for Verification: For the following products:
 - i Trim Accessories: Full-size Sample in 12-inch- (300-mm-) long length for each trim accessory indicated.
 - ii Textured Finishes: Manufacturer's standard size for each textured finish indicated and on same backing indicated for Work.
4. Delivery, Storage And Handling
 - a. Store materials inside under cover and keep them dry and protected against weather, condensation, direct sunlight, construction traffic, and other potential causes of damage. Stack panels flat and supported on risers on a flat platform to prevent sagging.

5. Field Conditions

- a. Environmental Limitations: Comply with ASTM C840 requirements or gypsum board manufacturer's written instructions, whichever are more stringent.
- b. Do not install paper-faced gypsum panels until installation areas are enclosed and conditioned.
- c. Do not install panels that are wet, moisture damaged, and mold damaged.
 - i. Indications that panels are wet or moisture damaged include, but are not limited to, discoloration, sagging, or irregular shape.
 - ii. Indications that panels are mold damaged include, but are not limited to, fuzzy or splotchy surface contamination and discoloration.

B Materials

B.1 SOURCE LIMITATIONS

- a. Obtain each type of gypsum panel and joint finishing material from single source with resources to provide products of consistent quality in appearance and physical properties.

B.2 PERFORMANCE REQUIREMENTS

- a. Fire-Resistance-Rated Assemblies: For fire-resistance-rated assemblies, provide materials and construction identical to those tested in assembly indicated according to ASTM E119 by an independent testing agency.

B.3 GYPSUM BOARD, GENERAL

- a. Size: Provide maximum lengths and widths available that will minimize joints in each area and that correspond with support system indicated.

B.4 INTERIOR GYPSUM BOARD

- a. Gypsum Wallboard: ASTM C1396/C1396M.
 - i. Manufacturers: National Gypsum, Georgia Pacific, USG, or approved equal
 - ii. Thickness: 5/8" inch (12.7 mm).
 - iii. Long Edges: Tapered Tapered and featured (rounded or beveled) for prefilling.
- b. Gypsum Board, Type X: ASTM C1396/C1396M.
 - i. Manufacturers: National Gypsum, Georgia Pacific, USG, or approved equal
 - ii. Thickness: 5/8 inch (15.9 mm).
 - iii. Long Edges: Tapered Tapered and featured (rounded or beveled) for prefilling.
- c. Gypsum Ceiling Board: ASTM C1396/C1396M.
 - i. Manufacturers: National Gypsum, Georgia Pacific, USG, or approved equal
- d. Thickness: 1/2 inch (12.7 mm).
- e. Long Edges: Tapered.
- f. Mold-Resistant Gypsum Board: ASTM C1396/C1396M. With moisture- and mold-resistant core and paper surfaces.
 - i. Core: As indicated on Drawings 1/2 inch (12.7 mm), regular type 5/8 inch (15.9 mm), Type X.
 - ii. Long Edges: Tapered.
 - iii. Mold Resistance: ASTM D3273, score of 10 as rated according to ASTM D3274.

- g. Glass-Mat Interior Gypsum Board: ASTM C1658/C1658M. With fiberglass mat laminated to both sides. Specifically designed for interior use.
 - i Core: As indicated on Drawings 1/2 inch (12.7 mm), regular type 1/2 inch (12.7 mm), Type C 5/8 inch (15.9 mm), Type X 5/8 inch (15.9 mm), abuse resistant.
 - ii Long Edges: Tapered.
 - iii Mold Resistance: ASTM D3273, score of 10 as rated according to ASTM D3274.

B.5 TILE BACKING PANELS

- a. Glass-Mat, Water-Resistant Backing Board: ASTM C1178/C1178M, with manufacturer's standard edges.
 - i Manufacturers: National Gypsum, Georgia Pacific, USG, or approved equal
 - ii Core: As indicated on Drawings 1/2 inch (12.7 mm), regular type 5/8 inch (15.9 mm), Type X.
 - iii Mold Resistance: ASTM D3273, score of 10 as rated according to ASTM D3274.
- b. Cementitious Backer Units: ANSI A118.9 and ASTM C1288 or ASTM C1325, with manufacturer's standard edges.
 - i Manufacturers: National Gypsum, Georgia Pacific, USG, or approved equal
 - ii Thickness: 1/4 inch (6.4 mm) 1/2 inch (12.7 mm) 5/8 inch (15.9 mm) As indicated on Drawings.
 - iii Mold Resistance: ASTM D3273, score of 10 as rated according to ASTM D3274.
 - iv Manufacturers: National Gypsum, Georgia Pacific, USG, or approved equal
 - v Core: As indicated on Drawings 5/8 inch (15.9 mm), Type X Type C as required by fire-resistance-rated assembly indicated on Drawings.

B.6 TRIM ACCESSORIES

- a. Interior Trim: ASTM C1047.
 - i Material: Galvanized or aluminum-coated steel sheet, rolled zinc, plastic, or paper-faced galvanized-steel sheet Galvanized or aluminum-coated steel sheet or rolled zinc Plastic Paper-faced galvanized-steel sheet.
 - ii Shapes:
 - 1) Cornerbead.
 - 2) Bullnose bead.
 - 3) LC-Bead: J-shaped; exposed long flange receives joint compound.
 - 4) L-Bead: L-shaped; exposed long flange receives joint compound.
 - 5) U-Bead: J-shaped; exposed short flange does not receive joint compound.
 - 6) Expansion (control) joint.
 - 7) Base-of-Wall PVC Moisture Barrier Trim: Extruded PVC, 1/2 inch (12.7 mm) 1-3/4 inch (44 mm) 3-1/2 inch (89 mm) high.
- b. Aluminum Trim: Extruded accessories of profiles and dimensions indicated.
 - i Aluminum: Alloy and temper with not less than the strength and durability properties of ASTM B221 (ASTM B221M), Alloy 6063-T5.
 - ii Finish: Corrosion-resistant primer compatible with joint compound and finish materials specified .

B.7 JOINT TREATMENT MATERIALS

- a. General: Comply with ASTM C475/C475M.
- b. Joint Tape:
 - i Interior Gypsum Board: Paper.
 - ii Exterior Gypsum Soffit Board: Paper.
 - iii Glass-Mat Gypsum Sheathing Board: 10-by-10 glass mesh.
 - iv Tile Backing Panels: As recommended by panel manufacturer.
- c. Joint Compound for Interior Gypsum Board: For each coat, use formulation that is compatible with other compounds applied on previous or for successive coats.
 - i Prefilling: At open joints, rounded or beveled panel edges, and damaged surface areas, use setting-type taping compound.
 - ii Embedding and First Coat: For embedding tape and first coat on joints, fasteners, and trim flanges, use setting-type taping drying-type, all-purpose compound.
 - 1) Use setting-type compound for installing paper-faced metal trim accessories.
 - iii Fill Coat: For second coat, use setting-type, sandable topping drying-type, all-purpose compound.
 - iv Finish Coat: For third coat, use setting-type, sandable topping drying-type, all-purpose compound.
 - v Skim Coat: For final coat of Level 5 finish, use setting-type, sandable topping compound drying-type, all-purpose compound high-build interior coating product designed for application by airless sprayer and to be used instead of skim coat to produce Level 5 finish.
- d. Joint Compound for Tile Backing Panels:
 - i Glass-Mat, Water-Resistant Backing Panel: As recommended by backing panel manufacturer.
 - ii Cementitious Backer Units: As recommended by backer unit manufacturer.

B.8 AUXILIARY MATERIALS

- a. Provide auxiliary materials that comply with referenced installation standards and manufacturer's written instructions.
- b. Laminating Adhesive: Adhesive or joint compound recommended for directly adhering gypsum panels to continuous substrate.
- c. Steel Drill Screws: ASTM C1002 unless otherwise indicated.
 - i Use screws complying with ASTM C954 for fastening panels to steel members from 0.033 to 0.112 inch (0.84 to 2.84 mm) thick.
 - ii For fastening cementitious backer units, use screws of type and size recommended by panel manufacturer.
- d. Thermal Insulation: As specified in Section "Thermal Insulation."
- e. Vapor Retarder: As specified in Section "Vapor Retarders."

B.9 TEXTURE FINISHES

- a. Primer: As recommended by textured finish manufacturer.
- b. Polystyrene Aggregate Ceiling Finish: Water-based, job-mixed, polystyrene aggregate finish with flame-spread and smoke-developed indexes of not more than 25 when tested according to ASTM E84.
 - i Texture: Fine

- c. Aggregate Finish: Water-based, job-mixed, aggregated, drying-type texture finish for spray application.
 - i Texture: Light spatter
- d. Non-Aggregate Finish: Premixed, vinyl texture finish for spray application.
 - i Texture: Orange peel

C Construction

C.1 EXAMINATION

- a. Examine areas and substrates including welded hollow-metal frames and support framing, with Installer present, for compliance with requirements and other conditions affecting performance of the Work.
- b. Examine panels before installation. Reject panels that are wet, moisture damaged, and mold damaged.
- c. Proceed with installation only after unsatisfactory conditions have been corrected.

C.2 INSTALLATION AND FINISHING OF PANELS, GENERAL

- a. Comply with ASTM C840.
- b. Install ceiling panels across framing to minimize the number of abutting end joints and to avoid abutting end joints in central area of each ceiling. Stagger abutting end joints of adjacent panels not less than one framing member.
- c. Install panels with face side out. Butt panels together for a light contact at edges and ends with not more than 1/16 inch (1.5 mm) of open space between panels. Do not force into place.
- d. Locate edge and end joints over supports, except in ceiling applications where intermediate supports or gypsum board back-blocking is provided behind end joints. Do not place tapered edges against cut edges or ends. Stagger vertical joints on opposite sides of partitions. Do not make joints other than control joints at corners of framed openings.
- e. Form control and expansion joints with space between edges of adjoining gypsum panels.
- f. Cover both faces of support framing with gypsum panels in concealed spaces (above ceilings, etc.), except in chases braced internally.
 - i Unless concealed application is indicated or required for sound, fire, air, or smoke ratings, coverage may be accomplished with scraps of not less than 8 sq. feet. (0.7 sq. m) in area.
 - ii Fit gypsum panels around ducts, pipes, and conduits.
 - iii Where partitions intersect structural members projecting below underside of floor/roof slabs and decks, cut gypsum panels to fit profile formed by structural members; allow 1/4- to 3/8-inch- (6.4- to 9.5-mm-) wide joints to install sealant.
- g. Isolate perimeter of gypsum board applied to non-load-bearing partitions at structural abutments. Provide 1/4- to 1/2-inch- (6.4- to 12.7-mm-) wide spaces at these locations and trim edges with edge trim where edges of panels are exposed. Seal joints between edges and abutting structural surfaces with acoustical sealant.
- h. Attachment to Steel Framing: Attach panels so leading edge or end of each panel is attached to open (unsupported) edges of stud flanges first.
- i. Install sound attenuation blankets before installing gypsum panels unless blankets are readily installed after panels have been installed on one side.

C.3 INSTALLATION OF INTERIOR GYPSUM BOARD

- a. Install interior gypsum board in the following locations:
 - i Wallboard Type: As indicated on Drawings.
 - ii Type X: As indicated on Drawings.
 - iii Ceiling Type: As indicated on Drawings Ceiling surfaces.
 - iv Mold-Resistant Type: As indicated on Drawings.
 - v Glass-Mat Interior Type: As indicated on Drawings.
- b. Single-Layer Application:
 - i On ceilings, apply gypsum panels before wall/partition board application to greatest extent possible and at right angles to framing unless otherwise indicated.
 - ii On partitions/walls, apply gypsum panels vertically (parallel to framing) horizontally (perpendicular to framing) unless otherwise indicated or required by fire-resistance-rated assembly, and minimize end joints.
 - 1) Stagger abutting end joints not less than one framing member in alternate courses of panels.
 - 2) At stairwells and other high walls, install panels horizontally unless otherwise indicated or required by fire-resistance-rated assembly.
 - iii On Z-shaped furring members, apply gypsum panels vertically (parallel to framing) with no end joints. Locate edge joints over furring members.
 - iv Fastening Methods: Apply gypsum panels to supports with steel drill screws.
- c. Multilayer Application:
 - i On ceilings, apply gypsum board indicated for base layers before applying base layers on walls/partitions; apply face layers in same sequence. Apply base layers at right angles to framing members and offset face-layer joints one framing member, 16 inches (400 mm) minimum, from parallel base-layer joints, unless otherwise indicated or required by fire-resistance-rated assembly.
 - ii On partitions/walls, apply gypsum board indicated for base layers and face layers vertically (parallel to framing) with joints of base layers located over stud or furring member and face-layer joints offset at least one stud or furring member with base-layer joints unless otherwise indicated or required by fire-resistance-rated assembly. Stagger joints on opposite sides of partitions.
 - iii On Z-shaped furring members, apply base layer vertically (parallel to framing) and face layer either vertically (parallel to framing) or horizontally (perpendicular to framing) with vertical joints offset at least one furring member. Locate edge joints of base layer over furring members.
 - iv Fastening Methods: Fasten base layers and face layers separately to supports with screws with screws; fasten face layers with adhesive and supplementary fasteners.
- d. Laminating to Substrate: Where gypsum panels are indicated as directly adhered to a substrate (other than studs, joists, furring members, or base layer of gypsum board), comply with gypsum board manufacturer's written instructions and temporarily brace or fasten gypsum panels until fastening adhesive has set.

C.4 INSTALLATION OF TILE BACKING PANELS

- a. Glass-Mat, Water-Resistant Backing Panels: Comply with manufacturer's written installation instructions and install at showers, tubs, and where indicated on Drawings locations indicated to receive tile. Install with 1/4-inch (6.4-mm) gap where panels abut other construction or penetrations.
- b. Cementitious Backer Units: ANSI A108.11, at showers, tubs, and where indicated on Drawings

- c. Water-Resistant Backing Board: Install where indicated with 1/4-inch (6.4-mm) gap where panels abut other construction or penetrations.
- d. Where tile backing panels abut other types of panels in same plane, shim surfaces to produce a uniform plane across panel surfaces.

C.5 INSTALLATION OF TRIM ACCESSORIES

- a. General: For trim with back flanges intended for fasteners, attach to framing with same fasteners used for panels. Otherwise, attach trim according to manufacturer's written instructions.
- b. Control Joints: Install control joints at locations indicated on Drawings according to ASTM C840 and in specific locations approved by Architect for visual effect.
- c. Interior Trim: Install in the following locations:
 - i Cornerbead: Use at outside corners unless otherwise indicated.
 - ii Bullnose Bead: Use at outside corners where indicated on Drawings.
 - iii LC-Bead: Use at exposed panel edges.
 - iv L-Bead: Use where indicated on Drawings.
 - v U-Bead: Use at exposed panel edges where indicated on Drawings.
 - vi Curved-Edge Cornerbead: Use at curved openings.
- d. Aluminum Trim: Install in locations indicated on Drawings.

C.6 FINISHING OF GYPSUM BOARD

- a. General: Treat gypsum board joints, interior angles, edge trim, control joints, penetrations, fastener heads, surface defects, and elsewhere as required to prepare gypsum board surfaces for decoration. Promptly remove residual joint compound from adjacent surfaces.
- b. Prefill open joints, rounded or beveled edges, and damaged surface areas.
- c. Apply joint tape over gypsum board joints, except for trim products specifically indicated as not intended to receive tape.
- d. Gypsum Board Finish Levels: Finish panels to levels indicated below and according to ASTM C840:
 - i Level 1: Ceiling plenum areas, concealed areas, and where indicated.
 - ii Level 2: Panels that are substrate for tile Panels that are substrate for acoustical tile Where indicated on Drawings.
 - iii Level 4: At panel surfaces that will be exposed to view unless otherwise indicated.
 - 1) Primer and its application to surfaces are specified in Section "Interior Painting."
 - iv Level 5: Where indicated on Drawings .
 - 1) Primer and its application to surfaces are specified in Section "Interior Painting."
- e. Glass-Mat Gypsum Sheathing Board: Finish according to manufacturer's written instructions for use as exposed soffit board.
- f. Glass-Mat Faced Panels: Finish according to manufacturer's written instructions.
- g. Cementitious Backer Units: Finish according to manufacturer's written instructions.

C.7 APPLICATION OF TEXTURE FINISHES

- a. Surface Preparation and Primer: Prepare and apply primer to gypsum panels and other surfaces receiving texture finishes. Apply primer to surfaces that are clean, dry, and smooth.
- b. Texture Finish Application: Mix and apply finish using powered spray equipment, to produce a uniform texture matching approved mockup and free of starved spots or other evidence of thin application or of application patterns.

- c. Prevent texture finishes from coming into contact with surfaces not indicated to receive texture finish by covering them with masking agents, polyethylene film, or other means. If, despite these precautions, texture finishes contact these surfaces, immediately remove droppings and overspray to prevent damage according to texture-finish manufacturer's written instructions.

C.8 PROTECTION

- a. Protect adjacent surfaces from drywall compound and promptly remove from floors and other non-drywall surfaces. Repair surfaces stained, marred, or otherwise damaged during drywall application.
- b. Protect installed products from damage from weather, condensation, direct sunlight, construction, and other causes during remainder of the construction period.
- c. Remove and replace panels that are wet, moisture damaged, and mold damaged.
 - i. Indications that panels are wet or moisture damaged include, but are not limited to, discoloration, sagging, or irregular shape.
 - ii. Indications that panels are mold damaged include, but are not limited to, fuzzy or splotchy surface contamination and discoloration.

C.9 GYPSUM BOARD SHAFT WALL ASSEMBLIES

C.9.1 DESCRIPTION OF GYPSUM BOARD SHAFT WALL ASSEMBLIES

1. RELATED DOCUMENTS

- a. Drawings and general provisions of the Contract, including General and Supplementary Conditions, apply to this Section.

2. SUMMARY

- a. Section Includes:
 - i. Gypsum board shaft wall assemblies.

3. ACTION SUBMITTALS

- a. Product Data: For each component of gypsum board shaft wall assembly.
- b. Sustainable Design Submittals:

4. DELIVERY, STORAGE, AND HANDLING

- a. Store materials inside under cover and keep them dry and protected against weather, condensation, direct sunlight, construction traffic, and other potential causes of damage. Stack panels flat and support them on risers on a flat platform to prevent sagging.

5. FIELD CONDITIONS

- a. Environmental Limitations: Comply with gypsum-shaftliner-board manufacturer's written instructions.
- b. Do not install finish panels until installation areas are enclosed and conditioned.
- c. Do not install panels that are wet, moisture damaged, or mold damaged.
 - i. Indications that panels are wet or moisture damaged include, but are not limited to, discoloration, sagging, and irregular shape.
 - ii. Indications that panels are mold damaged include, but are not limited to, fuzzy or splotchy surface contamination and discoloration.

C.10 MATERIALS - GYPSUM BOARD SHAFT ASSEMBLIES

1. PERFORMANCE REQUIREMENTS

- a. Fire-Resistance-Rated Assemblies: For fire-resistance-rated assemblies, provide materials and construction identical to those tested in assembly indicated according to ASTM E119 by an independent testing agency.

2. GYPSUM BOARD SHAFT WALL ASSEMBLIES

- a. Fire-Resistance Rating: As indicated on Drawings
- b. Gypsum Shaftliner Board:
 - i. Type X: ASTM C1396/C1396M; manufacturer's proprietary fire-resistive liner panels with paper faces, 1 inch (25.4 mm) thick, with double beveled long edges.
 - 1) USG or approved equal.
 - ii. Moisture- and Mold-Resistant Type X: ASTM C1396/C1396M; manufacturer's proprietary fire-resistive liner panels with ASTM D3273 mold-resistance score of 10 as rated according to ASTM D3274, 1 inch (25.4 mm) thick, and with double beveled long edges.
- c. Non-Load-Bearing Steel Framing, General: Complying with ASTM C645 requirements for metal unless otherwise indicated and complying with requirements for fire-resistance-rated assembly indicated.
 - i. Protective Coating: Coating with equivalent corrosion resistance of ASTM A653/A653M, G40 (Z120) ASTM A653/A653M, G40 (Z120), hot-dip galvanized ASTM A653/A653M, G60 (Z180), hot-dip galvanized unless otherwise indicated.
- d. Studs: Manufacturer's standard profile for repetitive, corner, and end members as follows:
 - i. Depth: As indicated 4 inches (102 mm) 6 inches (152 mm).
 - ii. Minimum Base-Metal Thickness: As indicated 0.018 inch (0.45 mm) 0.030 inch (0.75 mm) 0.033 inch (0.84 mm)
- e. Runner Tracks: Manufacturer's standard J-profile track with manufacturer's standard long-leg length, but at least 2 inches (51 mm) long and matching studs in depth.
 - i. Minimum Base-Metal Thickness: As indicated Matching steel studs 0.018 inch (0.45 mm) 0.021 inch (0.53 mm) 0.030 inch (0.75 mm) 0.033 inch (0.84 mm).
- f. Elevator-Hoistway-Entrance Struts: Manufacturer's standard J-profile jamb strut with long-leg length of 3 inches (76 mm), matching studs in depth, and not less than 0.033 inch (0.84 mm) thick.
- g. Finish Panels: Gypsum board as specified in "Gypsum Board." Cementitious backer units as specified in "Gypsum Board." Cementitious backer units as specified in "Ceramic Tiling." >.
- h. Sound Attenuation Blankets: As specified in "Gypsum Board." "Gypsum Veneer Plastering."

3. AUXILIARY MATERIALS

- a. Provide auxiliary materials that comply with shaft wall manufacturer's written instructions.
- b. Trim Accessories: Cornerbead, edge trim, and control joints of material and shapes as specified in Section "Gypsum Board" that comply with gypsum board shaft wall assembly manufacturer's written instructions for application indicated.
- c. Steel Drill Screws: ASTM C1002 unless otherwise indicated.
- d. Track Fasteners: Power-driven fasteners of size and material required to withstand loading conditions imposed on shaft wall assemblies without exceeding allowable design stress of track, fasteners, or structural substrates in which anchors are embedded.
 - i. Expansion Anchors: Fabricated from corrosion-resistant materials, with allowable load or strength design capacities calculated according to ICC-ES AC193 and ACI 318 greater than or equal to the design load, as determined by testing per ASTM E488/E488M conducted by a qualified testing agency.
- e. Reinforcing: Galvanized-steel reinforcing strips with 0.033-inch (0.84-mm) minimum thickness of base metal (uncoated).

- f. Gypsum Board Cants:
 - i. Gypsum Board Panels: As specified in Section "Gypsum Board," Type X, 1/2- or 5/8-inch (13- or 16-mm) panels.
 - ii. Adhesive: Laminating adhesive as specified in Section "Gypsum Board."
 - iii. Non-Load-Bearing Steel Framing: As specified in Section "Non-Structural Metal Framing."

C.11 CONSTRUCTION - GYPSUM BOARD SHAFT ASSEMBLIES

1. EXAMINATION

- a. Examine substrates and conditions, with Installer present, for compliance with requirements for installation tolerances and other conditions affecting performance of the Work.
- b. Examine panels before installation. Reject panels that are wet, moisture damaged, or mold damaged.
- c. Proceed with installation only after unsatisfactory conditions have been corrected.

2. PREPARATION

- a. Sprayed Fire-Resistive Materials: Coordinate with gypsum board shaft wall assemblies so both elements of Work remain complete and undamaged. Patch or replace sprayed fire-resistive materials removed or damaged during installation of shaft wall assemblies to comply with requirements specified in Section "Applied Fire Protection."
- b. After sprayed fire-resistive materials are applied, remove only to extent necessary for installation of gypsum board shaft wall assemblies and without reducing the fire-resistive material thickness below that which is required to obtain fire-resistance rating indicated. Protect remaining fire-resistive materials from damage.

3. INSTALLATION

- a. General: Install gypsum board shaft wall assemblies to comply with requirements of fire-resistance-rated assemblies indicated and manufacturer's written installation instructions.
- b. Do not bridge building expansion joints with shaft wall assemblies; frame both sides of expansion joints with furring and other support.
- c. Install supplementary framing in gypsum board shaft wall assemblies around openings and as required for blocking, bracing, and support of gravity and pullout loads of fixtures, equipment, services, heavy trim, furnishings, wall-mounted door stops, and similar items that cannot be supported directly by shaft wall assembly framing.
 - i. Elevator Hoistway: At elevator hoistway-entrance door frames, provide jamb struts on each side of door frame.
 - ii. Reinforcing: Provide where items attach directly to shaft wall assembly as indicated on Drawings; accurately position and secure behind at least one layer of face panel.
- d. Penetrations: At penetrations in shaft wall, maintain fire-resistance rating of shaft wall assembly by installing supplementary steel framing around perimeter of penetration and fire protection behind boxes containing wiring devices, elevator call buttons and floor indicators, and similar items.
- e. Isolate perimeter of gypsum panels from building structure to prevent cracking of panels while maintaining continuity of fire-rated construction.
- f. Firestop Tracks: Where indicated, install to maintain continuity of fire-resistance-rated assembly indicated.
- g. Control Joints: Install control joints at locations indicated on Drawings according to ASTM C840 and in specific locations approved by Architect while maintaining fire-resistance rating of gypsum board shaft wall assemblies.

- h. Sound-Rated Shaft Wall Assemblies: Seal gypsum board shaft walls with acoustical sealant at perimeter of each assembly where it abuts other work and at joints and penetrations within each assembly.
- i. Gypsum Board Cants: At projections into shaft exceeding 4 inches (102 mm) where indicated, install gypsum board cants covering tops of projections.
 - i Slope cant panels at least 75 degrees from horizontal. Set base edge of panels in adhesive and secure top edges to shaft walls at 24 inches (610 mm) o.c. with screws fastened to shaft wall framing.
 - ii Where non-load-bearing steel framing is required to support gypsum board cants, install framing at 24 inches (610 mm) o.c. and extend studs from the projection to shaft wall framing.
- j. Installation Tolerance: Install each framing member so fastening surfaces vary not more than 1/8 inch (3 mm) from the plane formed by faces of adjacent framing.

4. PROTECTION

- a. Protect installed products from damage from weather, condensation, direct sunlight, construction, and other causes during remainder of the construction period.
- b. Remove and replace panels that are wet, moisture damaged, or mold damaged.
 - i Indications that panels are wet or moisture damaged include, but are not limited to, discoloration, sagging, and irregular shape.

Indications that panels are mold damaged include, but are not limited to, fuzzy or splotchy surface contamination and discoloration.

C.11.2 DESCRIPTION – NON STRUCTURAL METAL FRAMING

1. SUMMARY

- a. Section Includes:
 - i Non-load-bearing steel framing systems for interior partitions.
 - ii Suspension systems for interior ceilings and soffits.
 - iii Grid suspension systems for gypsum board ceilings.
- b. Related Requirements:
 - i Section "Cold-Formed Metal Framing" for exterior and interior load-bearing and exterior non-load-bearing wall studs; floor joists; and roof rafters and ceiling joists.

2. ACTION SUBMITTALS

- a. Product Data: For each type of product.
- b. Sustainable Design Submittals:

3. INFORMATIONAL SUBMITTALS

- a. Product Certificates: For each type of code-compliance certification for studs and tracks.
- b. Evaluation Reports: For embossed, high-strength steel studs and tracks firestop tracks post-installed anchors and power-actuated fasteners, from ICC-ES or other qualified testing agency acceptable to authorities having jurisdiction.

4. QUALITY ASSURANCE

- a. Code-Compliance Certification of Studs and Tracks: Provide documentation that framing members are certified according to the product-certification program of the Certified Steel Stud Association the Steel Framing Industry Association the Steel Stud Manufacturers Association or the Supreme Steel Framing System Association.

5. DELIVERY, STORAGE, AND HANDLING

- a. Notify manufacturer of damaged materials received prior to installation.
- b. Deliver materials in manufacturer's original, unopened, undamaged containers with identification labels intact.
- c. Protect cold-formed metal framing from corrosion, deformation, and other damage during delivery, storage, and handling as required by AISI S202, "Code of Standard Practice for Cold-Formed Steel Structural Framing."

C.12 MATERIALS - NON STRUCTURAL METAL FRAMING

1. PERFORMANCE REQUIREMENTS

- a. Fire-Test-Response Characteristics: For fire-resistance-rated assemblies that incorporate non-load-bearing steel framing, provide materials and construction identical to those tested in assembly indicated, according to ASTM E119 by an independent testing agency.
- b. Horizontal Deflection: For composite non-composite wall assemblies, limited to 1/240 1/360 of the wall height based on horizontal loading of 5 lbf/sq. ft. (239 Pa) 10 lbf/sq. ft. (480 Pa).
- c. Design framing systems according to AISI S220, "North American Specification for the Design of Cold-Formed Steel Framing - Nonstructural Members," unless otherwise indicated.
- d. Design Loads: As indicated on architectural Drawings or 5 lbf/sq. ft. (239 Pa) minimum as required by the IBC.
- e. Design framing systems to accommodate deflection of primary building structure and construction tolerances and to withstand design loads.

2. FRAMING SYSTEMS

- a. Framing Members, General: Comply with AISI S220 for conditions indicated.
 - i Steel Sheet Components: Comply with AISI S220 requirements for metal unless otherwise indicated
 - ii Protective Coating: Comply with AISI S220; ASTM A653/A653M, G40 (Z120); or coating with equivalent corrosion resistance. Galvannealed products are unacceptable.
 - 1) Coating demonstrates equivalent corrosion resistance with an evaluation report acceptable to authorities having jurisdiction.
- b. Studs and Track: AISI S220.
 - i Manufacturer: Grainger or approved equal
 - ii Minimum Base-Steel Thickness: As indicated on Drawings and As required by performance requirements for horizontal deflection 0.0147 inch (0.373 mm) 0.0179 inch (0.455 mm) 0.0190 inch (0.483 mm) 0.0269 inch (0.683 mm) 0.0296 inch (0.752 mm) 0.0329 inch (0.836 mm).
 - iii Depth: As indicated on Drawings 3-5/8 inches (92 mm) 6 inches (152 mm) 4 inches (102 mm) 2-1/2 inches (64 mm) 1-5/8 inches (41 mm).
- c. Embossed, High Strength Steel Studs and Tracks: Roll-formed and embossed with surface deformations to stiffen the framing members so that they are structurally comparable to conventional ASTM C645 steel studs and tracks.
 - i Manufacturer: Grainger or approved equal
 - 1) Minimum Base-Steel Thickness: As required by horizontal deflection performance requirements 0.0147 inch (0.373 mm) 0.0190 inch (0.483 mm).
 - 2) Depth: As indicated on Drawings 3-5/8 inches (92 mm) 6 inches (152 mm) 4 inches (102 mm) 2-1/2 inches (64 mm) 1-5/8 inches (41 mm).

- d. Slip-Type Head Joints: Where indicated, provide one of the following:
 - i Clip System: Clips designed for use in head-of-wall deflection conditions that provide a positive attachment of studs to tracks while allowing 1-1/2-inch (38-mm) 2-inch (51-mm) 2-1/2-inch (64-mm) 3-inch (76-mm) minimum vertical movement.
 - ii Manufacturer: Grainger or approved equal.
 - iii Single Long-Leg Track System: ASTM C645 top track with 2-inch- (51-mm-) deep flanges in thickness not less than indicated for studs, installed with studs friction fit into top track and with continuous bridging located within 12 inches (305 mm) of the top of studs to provide lateral bracing.
 - iv Double-Track System: ASTM C645 top outer tracks, inside track with 2-inch- (51-mm-) deep flanges in thickness not less than indicated for studs and fastened to studs, and outer track sized to friction-fit over inner track.
 - v Deflection Track: Steel sheet top track manufactured to prevent cracking of finishes applied to interior partition framing resulting from deflection of structure above; in thickness not less than indicated for studs and in width to accommodate depth of studs.
 - vi Manufacturer: Grainger or approved equal
- e. Firestop Tracks: Top track manufactured to allow partition heads to expand and contract with movement of structure while maintaining continuity of fire-resistance-rated assembly indicated; in thickness not less than indicated for studs and in width to accommodate depth of studs.
 - i Manufacturer: Grainger or approved equal
- f. Flat Strap and Backing Plate: Steel sheet for blocking and bracing in length and width indicated.
 - i Manufacturer: Grainger or approved equal
 - ii Minimum Base-Steel Thickness: As indicated on Drawings 0.0179 inch (0.455 mm) 0.0269 inch (0.683 mm) 0.0296 inch (0.752 mm) 0.0329 inch (0.836 mm).
- g. Cold-Rolled Channel Bridging: Steel, 0.0538-inch (1.367-mm) minimum base-steel thickness, with minimum 1/2-inch- (13-mm-) wide flanges.
 - i Manufacturer: Grainger or approved equal
 - ii Depth: As indicated on Drawings 1-1/2 inches (38 mm) .
 - iii Clip Angle: Not less than 1-1/2 by 1-1/2 inches (38 by 38 mm), 0.068-inch- (1.72-mm-) thick, galvanized steel.
- h. Hat-Shaped, Rigid Furring Channels: ASTM C645.
 - i Manufacturer: Grainger or approved equal
 - ii Minimum Base-Steel Thickness: As indicated on Drawings 0.0179 inch (0.455 mm) 0.0296 inch (0.752 mm) 0.0329 inch (0.836 mm).
 - iii Depth: As indicated on Drawings 7/8 inch (22.2 mm) 1-1/2 inches (38 mm).
- i. Resilient Furring Channels: 1/2-inch- (13-mm-) deep, steel sheet members designed to reduce sound transmission.
 - i Manufacturer: Grainger or approved equal
 - ii Configuration: Asymmetrical or hat shaped.
- j. Cold-Rolled Furring Channels: 0.053-inch (1.34-mm) uncoated-steel thickness, with minimum 1/2-inch- (13-mm-) wide flanges.
 - i Depth: As indicated on Drawings 3/4 inch (19 mm) .
 - ii Furring Brackets: Adjustable, corrugated-edge-type steel sheet with minimum uncoated-steel thickness of 0.0329 inch (0.8 mm).

- iii Tie Wire: ASTM A641/A641M, Class 1 zinc coating, soft temper, 0.062-inch- (1.59-mm-) diameter wire, or double strand of 0.048-inch- (1.21-mm-) diameter wire.
 - k. Z-Shaped Furring: With slotted or nonslotted web, face flange of 1-1/4 inches (32 mm), wall attachment flange of 7/8 inch (22 mm), minimum uncoated-steel thickness of 0.0179 inch (0.455 mm), and depth required to fit insulation thickness indicated.
- 3. SUSPENSION SYSTEMS
 - a. Tie Wire: ASTM A641/A641M, Class 1 zinc coating, soft temper, 0.062-inch- (1.59-mm-) diameter wire, or double strand of 0.048-inch- (1.21-mm-) diameter wire.
 - b. Hanger Attachments to Concrete:
 - i Post-Installed Anchors: Fastener systems with an evaluation report acceptable to authorities having jurisdiction, based on ICC-ES AC01 AC193 AC58 or AC308 as appropriate for the substrate.
 - 1) Uses: Securing hangers to structure.
 - 2) Type: Torque-controlled, expansion anchor torque-controlled, adhesive anchor or adhesive anchor.
 - 3) Material for Interior Locations: Carbon-steel components zinc-plated to comply with ASTM B633 or ASTM F1941 (ASTM F1941M), Class Fe/Zn 5, unless otherwise indicated.
 - 4) Material for Exterior or Interior Locations and Where Stainless Steel Is Indicated: Alloy Group 1 (A1) Group 2 (A4) stainless steel bolts, ASTM F593 (ASTM F738M), and nuts, ASTM F594 (ASTM F836M).
 - ii Power-Actuated Anchors: Fastener systems with an evaluation report acceptable to authorities having jurisdiction, based on ICC-ES AC70.
 - c. Wire Hangers: ASTM A641/A641M, Class 1 zinc coating, soft temper, 0.16 inch (4.12 mm) in diameter.
 - d. Flat Hangers: Steel sheet, in size indicated on Drawings 1 by 3/16 inch (25 by 5 mm) by length indicated.
 - e. Carrying Channels (Main Runners): Cold-rolled, commercial-steel sheet with a base-steel thickness of 0.0538 inch (1.367 mm) and minimum 1/2-inch- (13-mm-) wide flanges.
 - i Depth: As indicated on Drawings 2-1/2 inches (64 mm) 2 inches (51 mm) 1-1/2 inches (38 mm).
 - f. Furring Channels (Furring Members):
 - i Cold-Rolled Channels: 0.0538-inch (1.367-mm) uncoated-steel thickness, with minimum 1/2-inch- (13-mm-) wide flanges, 3/4 inch (19 mm) deep.
 - ii Steel Studs and Tracks: ASTM C645.
 - 1) Minimum Base-Steel Thickness: As indicated on Drawings 0.0179 inch (0.455 mm) 0.0269 inch (0.683 mm) 0.0296 inch (0.752 mm) 0.0329 inch (0.836 mm).
 - 2) Depth: As indicated on Drawings 1-5/8 inches (41 mm) 2-1/2 inches (64 mm) 3-5/8 inches (92 mm).
 - iii Embossed, High-Strength Steel Studs and Tracks: ASTM C645.
 - 1) Minimum Base-Steel Thickness: As indicated on Drawings 0.0147 inch (0.373 mm) 0.0190 inch (0.483 mm).
 - 2) Depth: As indicated on Drawings 1-5/8 inches (41 mm) 2-1/2 inches (64 mm) 3-5/8 inches (92 mm).

- iv Hat-Shaped, Rigid Furring Channels: ASTM C645, 7/8 inch (22 mm) deep.
 - 1) Minimum Base-Steel Thickness: As indicated on Drawings 0.0179 inch (0.455 mm) 0.0296 inch (0.752 mm) 0.0329 inch (0.836 mm).
 - v Resilient Furring Channels: 1/2-inch- (13-mm-) deep members designed to reduce sound transmission.
 - 1) Configuration: Asymmetrical or hat shaped.
 - g. Grid Suspension System for Gypsum Board Ceilings: ASTM C645, direct-hung system composed of main beams and cross-furring members that interlock.
 - i Armstrong, USG or approved equal.
4. AUXILIARY MATERIALS
- a. General: Provide auxiliary materials that comply with referenced installation standards.
 - i Fasteners for Steel Framing: Of type, material, size, corrosion resistance, holding power, and other properties required to fasten steel members to substrates.
 - b. Isolation Strip at Exterior Walls: Provide one of the following:
 - i Asphalt-Saturated Organic Felt: ASTM D226/D226M, Type I (No. 15 asphalt felt), nonperforated.
 - ii Foam Gasket: Adhesive-backed, closed-cell vinyl foam strips that allow fastener penetration without foam displacement, 1/8 inch (3.2 mm) thick, in width to suit steel stud size.

C.13 CONSTRUCTION - NON STRUCTURAL METAL FRAMING

1. EXAMINATION
- a. Examine areas and substrates, with Installer present, and including welded hollow-metal frames, cast-in anchors, and structural framing, for compliance with requirements and other conditions affecting performance of the Work.
 - b. Proceed with installation only after unsatisfactory conditions have been corrected.
2. PREPARATION
- a. Suspended Assemblies: Coordinate installation of suspension systems with installation of overhead structure to ensure that inserts and other provisions for anchorages to building structure have been installed to receive hangers at spacing required to support the Work and that hangers will develop their full strength.
 - i Furnish concrete inserts and other devices indicated to other trades for installation in advance of time needed for coordination and construction.
 - b. Coordination with Sprayed Fire-Resistive Materials:
 - i Before sprayed fire-resistive materials are applied, attach offset anchor plates or ceiling tracks to surfaces indicated to receive sprayed fire-resistive materials. Where offset anchor plates are required, provide continuous plates fastened to building structure not more than 24 inches (610 mm) o.c.
 - ii After sprayed fire-resistive materials are applied, remove them only to extent necessary for installation of non-load-bearing steel framing. Do not reduce thickness of fire-resistive materials below that are required for fire-resistance ratings indicated. Protect adjacent fire-resistive materials from damage.
3. INSTALLATION, GENERAL
- a. Installation Standard: ASTM C754.
 - i Gypsum Board Assemblies: Also comply with requirements in ASTM C840 that apply to framing installation.

- b. Install framing and accessories plumb, square, and true to line, with connections securely fastened.
- c. Install supplementary framing, and blocking to support fixtures, equipment services, heavy trim, grab bars, toilet accessories, furnishings, or similar construction.
- d. Install bracing at terminations in assemblies.
- e. Do not bridge building control and expansion joints with non-load-bearing steel framing members. Frame both sides of joints independently.

4. INSTALLING FRAMED ASSEMBLIES

- a. Install framing system components according to spacings indicated, but not greater than spacings required by referenced installation standards for assembly types.
 - i Single-Layer Application: As required by horizontal deflection performance requirements 16 inches (406 mm) o.c. 24 inches (610 mm) o.c. unless otherwise indicated.
 - ii Multilayer Application: As required by horizontal deflection performance requirements 16 inches (406 mm) o.c. 24 inches (610 mm) o.c. unless otherwise indicated.
 - iii Tile Backing Panels: As required by horizontal deflection performance requirements 16 inches (406 mm) o.c. unless otherwise indicated.
- b. Where studs are installed directly against exterior masonry walls or dissimilar metals at exterior walls, install isolation strip between studs and exterior wall.
- c. Install studs so flanges within framing system point in same direction.
- d. Install tracks at floors and overhead supports. Extend framing full height to structural supports or substrates above suspended ceilings except where partitions are indicated to terminate at suspended ceilings. Continue framing around ducts that penetrate partitions above ceiling.
 - i Slip-Type Head Joints: Where framing extends to overhead structural supports, install to produce joints at tops of framing systems that prevent axial loading of finished assemblies.
 - ii Door Openings: Screw vertical studs at jambs to jamb anchor clips on door frames; install track section (for cripple studs) at head and secure to jamb studs.
 - 1) Install two studs at each jamb unless otherwise indicated.
 - 2) Install cripple studs at head adjacent to each jamb stud, with a minimum 1/2-inch (13-mm) clearance from jamb stud to allow for installation of control joint in finished assembly.
 - 3) Extend jamb studs through suspended ceilings and attach to underside of overhead structure.
 - iii Other Framed Openings: Frame openings other than door openings the same as required for door openings unless otherwise indicated. Install framing below sills of openings to match framing required above door heads.
 - iv Fire-Resistance-Rated Partitions: Install framing to comply with fire-resistance-rated assembly indicated and support closures and to make partitions continuous from floor to underside of solid structure.
 - 1) Firestop Track: Where indicated, install to maintain continuity of fire-resistance-rated assembly indicated.
 - v Sound-Rated Partitions: Install framing to comply with sound-rated assembly indicated.

- vi Curved Partitions:
 - 1) Bend track to uniform curve and locate straight lengths so they are tangent to arcs.
 - 2) Begin and end each arc with a stud, and space intermediate studs equally along arcs. On straight lengths of no fewer than two studs at ends of arcs, place studs 6 inches (150 mm) o.c.
- e. Direct Furring:
 - i Screw to wood framing.
 - ii Attach to concrete or masonry with stub nails, screws designed for masonry attachment, or powder-driven fasteners spaced 24 inches (610 mm) o.c.
- f. Z-Shaped Furring Members:
 - i Erect insulation, specified in Section "Thermal Insulation," vertically and hold in place with Z-shaped furring members spaced 24 inches (610 mm) o.c.
 - ii Except at exterior corners, securely attach narrow flanges of furring members to wall with concrete stub nails, screws designed for masonry attachment, or powder-driven fasteners spaced 24 inches (610 mm) o.c.
 - iii At exterior corners, attach wide flange of furring members to wall with short flange extending beyond corner; on adjacent wall surface, screw-attach short flange of furring channel to web of attached channel. At interior corners, space second member no more than 12 inches (305 mm) from corner and cut insulation to fit.
- g. Installation Tolerance: Install each framing member so fastening surfaces vary not more than 1/8 inch (3 mm) from the plane formed by faces of adjacent framing.

5. INSTALLING CEILING SUSPENSION SYSTEMS

- a. Install suspension system components according to spacings indicated, but not greater than spacings required by referenced installation standards for assembly types.
 - i Hangers: 48 inches (1219 mm) o.c.
 - ii Carrying Channels (Main Runners): 48 inches (1219 mm) o.c.
 - iii Furring Channels (Furring Members): 24 inches (610 mm) o.c.
- b. Isolate suspension systems from building structure where they abut or are penetrated by building structure to prevent transfer of loading imposed by structural movement.
- c. Suspend hangers from building structure as follows:
 - i Install hangers plumb and free from contact with insulation or other objects within ceiling plenum that are not part of supporting structural or suspension system.
 - 1) Splay hangers only where required to miss obstructions and offset resulting horizontal forces by bracing, countersplaying, or other equally effective means.
 - ii Where width of ducts and other construction within ceiling plenum produces hanger spacings that interfere with locations of hangers required to support standard suspension system members, install supplemental suspension members and hangers in the form of trapezes or equivalent devices.
 - 1) Size supplemental suspension members and hangers to support ceiling loads within performance limits established by referenced installation standards
 - iii Wire Hangers: Secure by looping and wire tying, either directly to structures or to inserts, eye screws, or other devices and fasteners that are secure and appropriate for substrate, and in a manner that will not cause hangers to deteriorate or otherwise fail.

- iv Flat Hangers: Secure to structure, including intermediate framing members, by attaching to inserts, eye screws, or other devices and fasteners that are secure and appropriate for structure and hanger, and in a manner that will not cause hangers to deteriorate or otherwise fail.
 - v Do not attach hangers to steel roof deck.
 - vi Do not attach hangers to permanent metal forms. Furnish cast-in-place hanger inserts that extend through forms.
 - vii Do not attach hangers to rolled-in hanger tabs of composite steel floor deck.
 - viii Do not connect or suspend steel framing from ducts, pipes, or conduit.
- d. Fire-Resistance-Rated Assemblies: Wire tie furring channels to supports.
 - e. Seismic Bracing: Sway-brace suspension systems with hangers used for support Grid suspension systems are suitable for use with gypsum board. They might be acceptable for gypsum veneer plaster; consult gypsum veneer plaster and grid suspension system manufacturers.
 - f. Grid Suspension Systems: Attach perimeter wall track or angle where grid suspension systems meet vertical surfaces. Mechanically join main beam and cross-furring members to each other and butt-cut to fit into wall track.
 - g. Installation Tolerances: Install suspension systems that are level to within 1/8 inch in 12 feet (3 mm in 3.6 m) measured lengthwise on each member that will receive finishes and transversely between parallel members that will receive finishes.

C.14 SPV. 0105.10 THERMAL INSULATION

C.14.1 DESCRIPTION THERMAL INSULATION

1. RELATED DOCUMENTS

- a. Drawings and general provisions of the Contract, including General and Supplementary Conditions, apply to this Section.

2. SUMMARY

a. Section Includes:

- i Extruded polystyrene foam-plastic board insulation.
- ii Molded (expanded) polystyrene foam-plastic board insulation.
- iii Polyisocyanurate foam-plastic board insulation.
- iv Glass-fiber blanket insulation.
- v Mineral-wool blanket insulation.
- vi Mineral-wool board insulation.

3. ACTION SUBMITTALS

a. Product Data: For the following:

- i Extruded polystyrene foam-plastic board insulation.
- ii Molded (expanded) polystyrene foam-plastic board insulation.
- iii Polyisocyanurate foam-plastic board insulation.
- iv Glass-fiber blanket insulation.
- v Glass-fiber board insulation.
- vi Mineral-wool blanket insulation.
- vii Mineral-wool board insulation.

4. INFORMATIONAL SUBMITTALS

- a. Installer's Certification: Listing type, manufacturer, and R-value of insulation installed in each element of the building thermal envelope.
 - i For blown-in or sprayed fiberglass and cellulosic-fiber loose-fill insulation, indicate initial installed thickness, settled thickness, settled R-value, installed density, coverage area, and number of bags installed.
 - ii Sign, date, and post the certification in a conspicuous location on Project site.
- b. Product Test Reports: For each product, for tests performed by a qualified testing agency.
- c. Research Reports: For foam-plastic insulation, from ICC-ES.

5. DELIVERY, STORAGE, AND HANDLING

- a. Protect insulation materials from physical damage and from deterioration due to moisture, soiling, and other sources. Store inside and in a dry location. Comply with manufacturer's written instructions for handling, storing, and protecting during installation.
- b. Protect foam-plastic board insulation as follows:
 - i Do not expose to sunlight except to necessary extent for period of installation and concealment.
 - ii Protect against ignition at all times. Do not deliver foam-plastic board materials to Project site until just before installation time.
 - iii Quickly complete installation and concealment of foam-plastic board insulation in each area of construction.

C.15 MATERIALS - THERMAL INSULATION

1. EXTRUDED POLYSTYRENE FOAM-PLASTIC BOARD INSULATION

- a. Extruded Polystyrene Board Insulation, Type X : ASTM C578, Type X, 15-psi (104-kPa) minimum compressive strength; unfaced.
 - i Owens Corning, Lewco, Anderson insulation or approved equal
 - ii Flame-Spread Index: Not more than 25 when tested according to ASTM E84.
 - iii Smoke-Developed Index: Not more than 450 when tested according to ASTM E84.
 - iv Fire Propagation Characteristics: Passes NFPA 285 testing as part of an approved assembly.
 - v Labeling: Provide identification of mark indicating R-value of each piece of insulation 12 inches (305 mm) and wider in width.
- b. Extruded Polystyrene Board Insulation, Type IV : ASTM C578, Type IV, 25-psi (173-kPa) minimum compressive strength; unfaced.
 - i Flame-Spread Index: Not more than 25 when tested according to ASTM E84.
 - ii Smoke-Developed Index: Not more than 450 when tested according to ASTM E84.
 - iii Fire Propagation Characteristics: Passes NFPA 285 testing as part of an approved assembly.
 - iv Labeling: Provide identification of mark indicating R-value of each piece of insulation 12 inches (305 mm) and wider in width.
- c. Extruded Polystyrene Board Insulation, Type IV, Drainage Panels: ASTM C578, Type IV, 25-psi (173-kPa) minimum compressive strength; unfaced; fabricated with shiplap or channel edges and with one side having grooved drainage channels.
 - i Flame-Spread Index: Not more than 25 when tested according to ASTM E84.
 - ii Smoke-Developed Index: Not more than 450 when tested according to ASTM E84.

- iii Labeling: Provide identification of mark indicating R-value of each piece of insulation 12 inches (305 mm) and wider in width.
 - d. Extruded Polystyrene Board Insulation, Type VI : ASTM C578, Type VI, 40-psi (276-kPa) minimum compressive strength.
 - i Flame-Spread Index: Not more than 25 when tested according to ASTM E84.
 - ii Smoke-Developed Index: Not more than 450 when tested according to ASTM E84.
 - iii Labeling: Provide identification of mark indicating R-value of each piece of insulation 12 inches (305 mm) and wider in width.
 - e. Extruded Polystyrene Board Insulation, Type VI, Drainage Panels : ASTM C578, Type VI, 40-psi (276-kPa) minimum compressive strength; unfaced; fabricated with shiplap or channel edges and with one side having grooved drainage channels.
 - i Flame-Spread Index: Not more than 25 when tested according to ASTM E84.
 - ii Smoke-Developed Index: Not more than 450 when tested according to ASTM E84.
 - iii Labeling: Provide identification of mark indicating R-value of each piece of insulation 12 inches (305 mm) and wider in width.
 - f. Extruded Polystyrene Board Insulation, Type VII : ASTM C578, Type VII, 60-psi (414-kPa) minimum compressive strength.
 - i Flame-Spread Index: Not more than 25 when tested according to ASTM E84.
 - ii Smoke-Developed Index: Not more than 450 when tested according to ASTM E84.
 - iii Labeling: Provide identification of mark indicating R-value of each piece of insulation 12 inches (305 mm) and wider in width.
 - g. Extruded Polystyrene Board Insulation, Type VII, Drainage Panels: ASTM C578, Type VII, 60-psi (414-kPa) minimum compressive strength; fabricated with shiplap or channel edges and with one side having grooved drainage channels.
 - i Flame-Spread Index: Not more than 25 when tested according to ASTM E84.
 - ii Smoke-Developed Index: Not more than 450 when tested according to ASTM E84.
 - iii Labeling: Provide identification of mark indicating R-value of each piece of insulation 12 inches (305 mm) and wider in width.
 - h. Extruded Polystyrene Board Insulation, Type V : ASTM C578, Type V, 100-psi (690-kPa) minimum compressive strength.
 - i Flame-Spread Index: Not more than 25 when tested according to ASTM E84.
 - ii Smoke-Developed Index: Not more than 450 when tested according to ASTM E84.
 - iii Labeling: Provide identification of mark indicating R-value of each piece of insulation 12 inches (305 mm) and wider in width.
2. MOLDED (EXPANDED) POLYSTYRENE FOAM-PLASTIC BOARD INSULATION
- a. Molded (Expanded) Polystyrene Board Insulation, Type I : ASTM C578, Type I, 10-psi (69-kPa) minimum compressive strength.
 - i Labeling: Provide identification of mark indicating R-value of each piece of insulation 12 inches (305 mm) and wider in width.
 - b. Molded (Expanded) Polystyrene Board Insulation, Type VIII : ASTM C578, Type VIII, 13-psi (90-kPa) minimum compressive strength.
 - i Labeling: Provide identification of mark indicating R-value of each piece of insulation 12 inches (305 mm) and wider in width.

- c. Molded (Expanded) Polystyrene Board Insulation, Type II : ASTM C578, Type II, 15-psi (104-kPa) minimum compressive strength.
 - i Labeling: Provide identification of mark indicating R-value of each piece of insulation 12 inches (305 mm) and wider in width.
- d. Molded (Expanded) Polystyrene Board Insulation, Type IX : ASTM C578, Type IX, 25-psi (173-kPa) minimum compressive strength.
 - i Labeling: Provide identification of mark indicating R-value of each piece of insulation 12 inches (305 mm) and wider in width.
- e. Molded (Expanded) Polystyrene Board Insulation, Type XIV : ASTM C578, Type XIV, 40-psi (276-kPa) minimum compressive strength.
 - i Labeling: Provide identification of mark indicating R-value of each piece of insulation 12 inches (305 mm) and wider in width.
- f. Molded (Expanded) Polystyrene Board Insulation, Type XV : ASTM C578, Type XV, 60-psi (414-kPa) minimum compressive strength.
 - i Labeling: Provide identification of mark indicating R-value of each piece of insulation 12 inches (305 mm) and wider in width.

3. GRAPHITE-POLYSTYRENE FOAM-PLASTIC BOARD

- a. Graphite-Polystyrene Foam-Plastic Board, Type I: ASTM C578, Type I, 10-psi (69-kPa) minimum compressive strength; maximum flame-spread and smoke-developed indexes of 25 and 450, respectively, per ASTM E84; 4-perm (230-ng/Pa x s x sq. m) maximum vapor permeance at 1-inch (25.4-mm) thickness per ASTM E96; R4.7 minimum stable R-value at 1-inch (25.4-mm) thickness per ASTM C518.
 - i Labeling: Provide identification of mark indicating R-value of each piece of insulation 12 inches (305 mm) and wider in width.
- b. Graphite-Polystyrene Foam-Plastic Board, Type I, Faced: ASTM C578, Type I, 10-psi (69-kPa) minimum compressive strength; maximum flame-spread and smoke-developed indexes of 25 and 450, respectively, per ASTM E84; 4-perm (230-ng/Pa x s x sq. m) maximum vapor permeance at 1-inch (25.4-mm) thickness per ASTM E96; R4.7 minimum stable R-value at 1-inch (25.4-mm) thickness per ASTM C518.
 - i Graphite-Polystyrene Labeling: Provide identification of mark indicating R-value of each piece of insulation 12 inches (305 mm) and wider in width.
- c. Foam-Plastic Board, Type VIII: ASTM C578, Type VIII, 13-psi (90-kPa) minimum compressive strength; maximum flame-spread and smoke-developed indexes of 25 and 450, respectively, per ASTM E84; 3.1-perm (178-ng/Pa x s x sq. m) maximum vapor permeance at 1-inch (25.4-mm) thickness per ASTM E96; R4.7 minimum stable R-value at 1-inch (25.4-mm) thickness per ASTM C518.
 - i Labeling: Provide identification of mark indicating R-value of each piece of insulation 12 inches (305 mm) and wider in width.
- d. Graphite-Polystyrene Foam-Plastic Board, Type VIII, Faced: ASTM C578, Type VIII, 13-psi (90-kPa) minimum compressive strength; maximum flame-spread and smoke-developed indexes of 25 and 450, respectively, per ASTM E84; 3.1-perm (178-ng/Pa x s x sq. m) maximum vapor permeance at 1-inch (25.4-mm) thickness per ASTM E96; R4.7 minimum stable R-value at 1-inch (25.4-mm) thickness per ASTM C518.
 - i Labeling: Provide identification of mark indicating R-value of each piece of insulation 12 inches (305 mm) and wider in width.

- e. Graphite-Polystyrene Foam-Plastic Board, Type II : ASTM C578, Type II, 15-psi (104-kPa) minimum compressive strength; maximum flame-spread and smoke-developed indexes of 25 and 450, respectively, per ASTM E84; 3.1-perm (178-ng/Pa x s x sq. m) maximum vapor permeance at 1-inch (25.4-mm) thickness per ASTM E96; R4.7 minimum stable R-value at 1-inch (25.4-mm) thickness per ASTM C518.
 - i Labeling: Provide identification of mark indicating R-value of each piece of insulation 12 inches (305 mm) and wider in width.
- f. Graphite-Polystyrene Foam-Plastic Board, Type IX : ASTM C578, Type IX, 25-psi (173-kPa) minimum compressive strength; maximum flame-spread and smoke-developed indexes of 25 and 450, respectively, per ASTM E84; 2.5-perm (144-ng/Pa x s x sq. m) maximum vapor permeance at 1-inch (25.4-mm) thickness per ASTM E96; R4.7 minimum stable R-value at 1-inch (25.4-mm) thickness per ASTM C518.
 - i Labeling: Provide identification of mark indicating R-value of each piece of insulation 12 inches (305 mm) and wider in width.
- g. Graphite-Polystyrene Foam-Plastic Board, Type IX, Faced: ASTM C578, Type IX, 25-psi (173-kPa) minimum compressive strength; maximum flame-spread and smoke-developed indexes of 25 and 450, respectively, per ASTM E84; 2.5-perm (144-ng/Pa x s x sq. m) maximum vapor permeance at 1-inch (25.4-mm) thickness per ASTM E96; R4.7 minimum stable R-value at 1-inch (25.4-mm) thickness per ASTM C518.
 - i Labeling: Provide identification of mark indicating R-value of each piece of insulation 12 inches (305 mm) and wider in width.
- h. Graphite-Polystyrene Foam-Plastic Board, Type XIV: ASTM C578, Type XIV, 40-psi (276-kPa) minimum compressive strength; maximum flame-spread and smoke-developed indexes of 25 and 450, respectively, per ASTM E84; 2.5-perm (144-ng/Pa x s x sq. m) maximum vapor permeance at 1-inch (25.4-mm) thickness per ASTM E96; R4.7 minimum stable R-value at 1-inch (25.4-mm) thickness per ASTM C518.
 - i Labeling: Provide identification of mark indicating R-value of each piece of insulation 12 inches (305 mm) and wider in width.
- i. Graphite-Polystyrene Foam-Plastic Board, Type XV: ASTM C578, Type XV, 60-psi (414-kPa) minimum compressive strength; maximum flame-spread and smoke-developed indexes of 25 and 450, respectively, per ASTM E84; 2.5-perm (144-ng/Pa x s x sq. m) maximum vapor permeance at 1-inch (25.4-mm) thickness per ASTM E96; R4.7 minimum stable R-value at 1-inch (25.4-mm) thickness per ASTM C518.
 - i Labeling: Provide identification of mark indicating R-value of each piece of insulation 12 inches (305 mm) and wider in width.
- j. Graphite-Polystyrene Foam-Plastic Board, Type X, Faced : ASTM C578, Type X, 15-psi (104-kPa) minimum compressive strength; maximum flame-spread and smoke-developed indexes of 25 and 450, respectively, per ASTM E84; 1.1-perm (63-ng/Pa x s x sq. m) maximum vapor permeance at 1-inch (25.4-mm) thickness per ASTM E96; R4.7 minimum stable R-value at 1-inch (25.4-mm) thickness per ASTM C518.
 - i Labeling: Provide identification of mark indicating R-value of each piece of insulation 12 inches (305 mm) and wider in width.
- k. Graphite-Polystyrene Foam-Plastic Board, Type IV, Faced: ASTM C578, Type IV, 25-psi (173-kPa) minimum compressive strength; maximum flame-spread and smoke-developed indexes of 25 and 450, respectively, per ASTM E84; 1.1-perm (63-ng/Pa x s x sq. m) maximum vapor permeance at 1-inch (25.4-mm) thickness per ASTM E96; R4.7 minimum stable R-value at 1-inch (25.4-mm) thickness per ASTM C518.
 - i Labeling: Provide identification of mark indicating R-value of each piece of insulation 12 inches (305 mm) and wider in width.

4. POLYISOCYANURATE FOAM-PLASTIC BOARD INSULATION

- a. Polyisocyanurate Board Insulation, Foil Faced: ASTM C1289, foil faced, Type I, Class 1 or 2.
 - i Fire Characteristics: Passes NFPA 285 testing as part of an approved assembly.
 - ii Labelin Propagation g: Provide identification of mark indicating R-value of each piece of insulation 12 inches (305 mm) and wider in width.
- b. Polyisocyanurate Board Insulation, Glass-Fiber-Mat Faced: ASTM C1289, glass-fiber-mat faced, Type II, Class 2.
 - i Fire Propagation Characteristics: Passes NFPA 285 testing as part of an approved assembly.
 - ii Labeling: Provide identification of mark indicating R-value of each piece of insulation 12 inches (305 mm) and wider in width.

5. GLASS-FIBER BLANKET INSULATION

- a. Glass-Fiber Blanket Insulation, Unfaced: ASTM C665, Type I; passing ASTM E136 for combustion characteristics.
 - i Flame-Spread Index: Not more than 25 when tested according to ASTM E84.
 - ii Smoke-Developed Index: Not more than 50 when tested according to ASTM E84.
 - iii Labeling: Provide identification of mark indicating R-value of each piece of insulation 12 inches (305 mm) and wider in width.
- b. Glass-Fiber Blanket Insulation, Polypropylene-Scrim-Kraft Faced: ASTM C665, Type II (nonreflective faced), Class A (faced surface with a flame-spread index of 25 or less); Category 1 (membrane is a vapor barrier)
 - i Labeling: Provide identification of mark indicating R-value of each piece of insulation 12 inches (305 mm) and wider in width.
- c. Glass-Fiber Blanket Insulation, Kraft Faced: ASTM C665, Type II (nonreflective faced), Class C (faced surface not rated for flame propagation); Category 1 (membrane is a vapor barrier).
 - i Labeling: Provide identification of mark indicating R-value of each piece of insulation 12 inches (305 mm) and wider in width.
- d. Glass-Fiber Blanket Insulation, Reinforced-Foil Faced: ASTM C665, Type III (reflective faced), Class A (faced surface with a flame-spread index of 25 or less); Category 1 (membrane is a vapor barrier), faced with foil scrim, foil-scrim kraft, or foil-scrim polyethylene.
 - i Labeling: Provide identification of mark indicating R-value of each piece of insulation 12 inches (305 mm) and wider in width.
- e. Glass-Fiber Blanket Insulation, Foil Faced: ASTM C665, Type III (reflective faced), Class B (faced surface with a flame-propagation resistance of 0.12 W/sq. cm); Category 1 (membrane is a vapor barrier), faced with foil scrim, foil-scrim kraft, or foil-scrim polyethylene.
 - i Labeling: Provide identification of mark indicating R-value of each piece of insulation 12 inches (305 mm) and wider in width.

6. GLASS-FIBER BOARD INSULATION

- a. Glass-Fiber Board Insulation, Unfaced : ASTM C612, Type IA; unfaced, passing ASTM E136 for combustion characteristics.
 - i Flame-Spread Index: Not more than 25 when tested according to ASTM E84.
 - ii Smoke-Developed Index: Not more than 50 when tested according to ASTM E84.
 - iii Nominal Density: 2.25 lb/cu. feet (36 kg/cu. m) 3 lb/cu. ft. (48 kg/cu. m) 4.25 lb/cu. feet (68 kg/cu. m) 6 lb/cu. ft. (96 kg/cu. m).

- iv Thermal Resistivity: 4.3 deg F x h x sq. ft./Btu x in. at 75 deg F (29.8 K x m/W at 24 deg C).
 - v Labeling: Provide identification of mark indicating R-value of each piece of insulation 12 inches (305 mm) and wider in width.
- b. Glass-Fiber Board Insulation, Faced : ASTM C612, Type IA; faced on one side with foil-scrim-kraft or foil-scrim-polyethylene vapor retarder.
- i Flame-Spread Index: Not more than 25 when tested according to ASTM E84.
 - ii Smoke-Developed Index: Not more than 50 when tested according to ASTM E84.
 - iii Nominal Density: 2.25 lb/cu. ft. (36 kg/cu. m) 3 lb/cu. ft. (48 kg/cu. m) 4.25 lb/cu. feet. (68 kg/cu. m) 6 lb/cu. ft. (96 kg/cu. m).
 - iv Thermal Resistivity: 4.3 deg F x h x sq. ft./Btu x in. at 75 deg F (29.8 K x m/W at 24 deg C).
 - v Labeling: Provide identification of mark indicating R-value of each piece of insulation 12 inches (305 mm) and wider in width.

7. MINERAL-WOOL BLANKET INSULATION

- a. Mineral-Wool Blanket Insulation, Unfaced: ASTM C665, Type I (blankets without membrane facing); consisting of fibers; passing ASTM E136 for combustion characteristics.
- i Flame-Spread Index: Not more than 25 when tested according to ASTM E84.
 - ii Smoke-Developed Index: Not more than 50 when tested according to ASTM E84.
 - iii Labeling: Provide identification of mark indicating R-value of each piece of insulation 12 inches (305 mm) and wider in width.
- b. Mineral-Wool Blanket Insulation, Reinforced-Foil Faced: ASTM C665, Type III (reflective faced); Category 1 (membrane is a vapor barrier), faced with foil scrim, foil-scrim kraft, or foil-scrim polyethylene.
- i Flame-Spread Index: Not more than 25 when tested according to ASTM E84.
 - ii Smoke-Developed Index: Not more than 50 when tested according to ASTM E84.
 - iii Labeling: Provide identification of mark indicating R-value of each piece of insulation 12 inches (305 mm) and wider in width.

8. MINERAL-WOOL BOARD INSULATION

- a. Mineral-Wool Board Insulation, Types IA and IB, Unfaced: ASTM C612, Types IA and IB; passing ASTM E136 for combustion characteristics.
- i Nominal Density: 4 lb/cu. ft. (64 kg/cu. m).
 - ii Flame-Spread Index: Not more than 15 when tested according to ASTM E84.
 - iii Smoke-Developed Index: Not more than zero when tested according to ASTM E84.
 - iv Labeling: Provide identification of mark indicating R-value of each piece of insulation 12 inches (305 mm) and wider in width.
- b. Mineral-Wool Board Insulation, Types IA and IB, Faced: ASTM C612, Types IA and IB; faced on one side with foil-scrim or foil-scrim-polyethylene vapor retarder.
- i Nominal Density: 4 lb/cu. ft. (64 kg/cu. m).
 - ii Flame-Spread Index: Not more than 15 when tested according to ASTM E84.
 - iii Smoke-Developed Index: Not more than zero when tested according to ASTM E84.
 - iv Labeling: Provide identification of mark indicating R-value of each piece of insulation 12 inches (305 mm) and wider in width.

- c. Mineral-Wool Board Insulation, Type II, Unfaced: ASTM C612, Type II; passing ASTM E136 for combustion characteristics.
 - i Nominal Density: 6 lb/cu. ft. (96 kg/cu. m).
 - ii Flame-Spread Index: Not more than 15 when tested according to ASTM E84.
 - iii Smoke-Developed Index: Not more than zero when tested according to ASTM E84.
 - iv Labeling: Provide identification of mark indicating R-value of each piece of insulation 12 inches (305 mm) and wider in width.
- d. Mineral-Wool Board Insulation, Type II, Faced: ASTM C612, Type II; faced on one side with foil-scrim or foil-scrim-polyethylene vapor retarder.
 - i Nominal Density: 6 lb/cu. ft. (96 kg/cu. m).
 - ii Flame-Spread Index: Not more than 15 when tested according to ASTM E84.
 - iii Smoke-Developed Index: Not more than zero when tested according to ASTM E84.
 - iv Labeling: Provide identification of mark indicating R-value of each piece of insulation 12 inches (305 mm) and wider in width.
- e. Mineral-Wool Board Insulation, Type III, Unfaced: ASTM C612, Type III; passing ASTM E136 for combustion characteristics.
 - i Nominal Density: 8 lb/cu. ft. (128 kg/cu. m).
 - ii Flame-Spread Index: Not more than 15 when tested according to ASTM E84.
 - iii Smoke-Developed Index: Not more than zero when tested according to ASTM E84.
 - iv Labeling: Provide identification of mark indicating R-value of each piece of insulation 12 inches (305 mm) and wider in width.
- f. Mineral-Wool Board Insulation, Type III, Faced : ASTM C612, Type III; faced on one side with foil-scrim or foil-scrim-polyethylene vapor retarder.
 - i Nominal Density: 8 lb/cu. ft. (128 kg/cu. m).
 - ii Flame-Spread Index: Not more than 15 when tested according to ASTM E84.
 - iii Smoke-Developed Index: Not more than zero when tested according to ASTM E84.
 - iv Labeling: Provide identification of mark indicating R-value of each piece of insulation 12 inches (305 mm) and wider in width.

9. SPRAY-APPLIED CELLULOSIC INSULATION

- a. Self-Supported, Spray-Applied Cellulosic Insulation : ASTM C1149, Type I (materials applied with liquid adhesive; suitable for either exposed or enclosed applications), Type II (materials containing a dry adhesive activated by water during installation; intended only for enclosed or covered applications), Type III (materials containing an adhesive mixed with water during application; intended for application on attic floors), chemically treated for flame-resistance, processing, and handling characteristics.

10. CELLULAR GLASS INSULATION

- a. Cellular Glass Insulation : ASTM C552, Type I (flat block) Type IV (board) faced on both sides with manufacturer's special kraft-paper sheets laminated to glass block with asphalt.
 - i Labeling: Provide identification of mark indicating R-value of each piece of insulation 12 inches (305 mm) and wider in width.

11. REFLECTIVE INSULATION

- a. Reflective Insulation: ASTM C1224, with one or more low-emittance surfaces with emittance value of 0.1 or less as measured per ASTM C1371.
 - i Construction: Surfaces separated with internal expanders Surfaces separated by single-layer polyethylene bubble film Surfaces separated by double-layer polyethylene bubble film.
 - ii Surface-Burning Characteristics: Maximum flame spread and smoke developed indexes of 25 and 50 25 and 450 , respectively when tested according to ASTM E84.
 - iii Water-Vapor Transmission: 1 perm, maximum 5 perms or greater.
- b. Sheet Radiant Barrier: ASTM C1313/C1313M with at least one surface with emittance value of 0.1 or less as measured per ASTM C1371.
 - i Construction: Foil on one side of substrate Foil on both sides of substrate Vacuum metallizing on substrate.
 - ii Surface-Burning Characteristics: Maximum flame spread and smoke developed indexes of 5 and 10 , respectively when tested according to ASTM E84.
 - iii Tear Resistance:.
 - iv Water-Vapor Transmission: 1 perm, maximum 5 perms or greater.
 - v Sheet Width: .
- c. Interior Radiation Control Coating System: Silver-colored, low-emissivity, solvent water-based coating; with a surface emittance value of 0.25 or less as measured per ASTM C1371.

12. INSULATION FASTENERS

- a. Adhesively Attached, Spindle-Type Anchors: Plate welded to projecting spindle; capable of holding insulation of specified thickness securely in position with self-locking washer in place.
 - i Plate: Perforated, galvanized carbon-steel sheet, 0.030 inch (0.762 mm) thick by 2 inches (50 mm) square.
 - ii Spindle: Copper-coated, low-carbon steel; fully annealed; 0.105 inch (2.67 mm) in diameter; length to suit depth of insulation.
- b. Adhesively Attached, Angle-Shaped, Spindle-Type Anchors: Angle welded to projecting spindle; capable of holding insulation of specified thickness securely in position with self-locking washer in place.
 - i Angle: Formed from 0.030-inch- (0.762-mm-) thick, perforated, galvanized carbon-steel sheet with each leg 2 inches (50 mm) square.
 - ii Spindle: Copper-coated, low-carbon steel; fully annealed; 0.105 inch (2.67 mm) in diameter; length to suit depth of insulation.
- c. Insulation-Retaining Washers: Self-locking washers formed from 0.016-inch- (0.41-mm-) thick galvanized-steel sheet, with beveled edge for increased stiffness, sized as required to hold insulation securely in place, but not less than 1-1/2 inches (38 mm) square or in diameter.
 - i Protect ends with capped self-locking washers incorporating a spring steel insert to ensure permanent retention of cap in the following locations:
 - 1) Crawl spaces.
 - 2) Ceiling plenums.
 - 3) Attic spaces.
 - 4) Insulation Standoff: Spacer fabricated from galvanized mild-steel sheet for fitting over spindle of insulation anchor to maintain air space of 1 inch (25 mm) 2 inches (50 mm) 3 inches (76 mm) between face of insulation and substrate to which anchor is attached.

- d. Adhesive: Product with demonstrated capability to bond insulation anchors securely to substrates without damaging insulation, fasteners, or substrates.

13. ACCESSORIES

- a. Insulation for Miscellaneous Voids:
 - i. Glass-Fiber Insulation: ASTM C764, Type II, loose fill; with maximum flame-spread and smoke-developed indexes of 5, per ASTM E84.
 - ii. Spray Polyurethane Foam Insulation: ASTM C1029, Type II, closed cell, with maximum flame-spread and smoke-developed indexes of 75 and 450, respectively, per ASTM E84.
 - iii. Polyurethane Pour-In-Place Insulation: Closed cell, with maximum flame-spread and smoke-developed indexes of 75 and 450, respectively, per ASTM E84, specifically formulated for pour-in-place applications.
- b. Adhesive for Bonding Insulation: Product compatible with insulation and air and water barrier materials, and with demonstrated capability to bond insulation securely to substrates without damaging insulation and substrates.
- c. Asphalt Coating for Cellular-Glass Block Insulation: Cutback asphalt or asphalt emulsion of type recommended by manufacturer of cellular-glass block insulation.
- d. Eave Ventilation Troughs: Preformed, rigid fiberboard or plastic sheets designed and sized to fit between roof framing members and to provide ventilation between insulated attic spaces and vented eaves.

C.16 CONSTRUCTION THERMAL INSULATION

1. PREPARATION

- a. Clean substrates of substances that are harmful to insulation, including removing projections capable of puncturing insulation or vapor retarders, or that interfere with insulation attachment.

2. INSTALLATION, GENERAL

- a. Comply with insulation manufacturer's written instructions applicable to products and applications.
- b. Install insulation that is undamaged, dry, and unsoiled and that has not been left exposed to ice, rain, or snow at any time.
- c. Install insulation with manufacturer's R-value label exposed after insulation is installed.
- d. Extend insulation to envelop entire area to be insulated. Fit tightly around obstructions and fill voids with insulation. Remove projections that interfere with placement.
- e. Provide sizes to fit applications and selected from manufacturer's standard thicknesses, widths, and lengths. Apply single layer of insulation units unless multiple layers are otherwise shown or required to make up total thickness or to achieve R-value.

3. INSTALLATION OF SLAB INSULATION

- a. On vertical slab edge and foundation surfaces, set insulation units using manufacturer's recommended adhesive according to manufacturer's written instructions.
 - i. If not otherwise indicated, extend insulation a minimum of 24 inches (610 mm) 36 inches (915 mm) below exterior grade line.
- b. On horizontal surfaces, loosely lay insulation units according to manufacturer's written instructions. Stagger end joints and tightly abut insulation units.
 - i. If not otherwise indicated, extend insulation a minimum of 24 inches (610 mm) 36 inches (915 mm) in from exterior walls.

4. INSTALLATION OF FOUNDATION WALL INSULATION

- a. Butt panels together for tight fit.
- b. Anchor Installation: Install board insulation on concrete substrates by adhesively attached, spindle-type insulation anchors as follows:
 - i. Fasten insulation anchors to concrete substrates with insulation anchor adhesive according to anchor manufacturer's written instructions.
 - ii. Space anchors according to insulation manufacturer's written instructions for insulation type, thickness, and application.
 - iii. Apply insulation standoffs to each spindle to create cavity width indicated on Drawings between concrete substrate and insulation.
 - iv. After adhesive has dried, install board insulation by pressing insulation into position over spindles and securing it tightly in place with insulation-retaining washers, taking care not to compress insulation.
 - v. Where insulation will not be covered by other building materials, apply capped washers to tips of spindles.
- c. Adhesive Installation: Install with adhesive or press into tacky waterproofing or dampproofing according to manufacturer's written instructions.

5. INSTALLATION OF CAVITY-WALL INSULATION

- a. Foam-Plastic Board Insulation: Install pads of adhesive spaced approximately 24 inches (610 mm) o.c. both ways on inside face and as recommended by manufacturer.
 - i. Fit courses of insulation between wall ties and other obstructions, with edges butted tightly in both directions, and with faces flush.
 - ii. Press units firmly against inside substrates.
 - iii. Supplement adhesive attachment of insulation by securing boards with two-piece wall ties designed for this purpose and specified in Section "Unit Masonry."
- b. Cellular-Glass Board Insulation: Install with closely fitting joints using adhesive pad serrated trowel attachment method according to manufacturer's written instructions.
- c. Mineral-Wool Board Insulation: Install insulation fasteners 4 inches (100 mm) from each corner of board insulation, at center of board, and as recommended by manufacturer.
 - i. Fit courses of insulation between masonry wall ties and other obstructions, with edges butted tightly in both directions, and with faces flush.
 - ii. Press units firmly against inside substrates.

6. INSTALLATION OF INSULATION IN FRAMED CONSTRUCTION

- a. Blanket Insulation: Install in cavities formed by framing members according to the following requirements:
 - i. Use insulation widths and lengths that fill the cavities formed by framing members. If more than one length is required to fill the cavities, provide lengths that will produce a snug fit between ends.
 - ii. Place insulation in cavities formed by framing members to produce a friction fit between edges of insulation and adjoining framing members.
 - iii. Maintain 3-inch (76-mm) clearance of insulation around recessed lighting fixtures not rated for or protected from contact with insulation.
 - iv. Attics: Install eave ventilation troughs between roof framing members in insulated attic spaces at vented eaves.

- v For metal-framed wall cavities where cavity heights exceed 96 inches (2438 mm), support unfaced blankets mechanically and support faced blankets by taping flanges of insulation to flanges of metal studs.
- vi For wood-framed construction, install blankets according to ASTM C1320 and as follows:
 - 1) With faced blankets having stapling flanges, lap blanket flange over flange of adjacent blanket to maintain continuity of vapor retarder once finish material is installed over it.
- vii Vapor-Retarder-Faced Blankets: Tape joints and ruptures in vapor-retarder facings and seal each continuous area of insulation to ensure airtight installation.
 - 1) Exterior Walls: Set units with facing placed toward exterior of construction interior of construction as indicated on Drawings.
 - 2) Interior Walls: Set units with facing placed as indicated on Drawings toward areas of high humidity.
- b. Miscellaneous Voids: Install insulation in miscellaneous voids and cavity spaces where required to prevent gaps in insulation using the following materials:
 - i Glass-Fiber Insulation: Compact to approximately 40 percent of normal maximum volume equaling a density of approximately 2.5 lb/cu. feet. (40 kg/cu. m).
 - ii Spray Polyurethane Insulation: Apply according to manufacturer's written instructions.
- c. Loose-Fill Insulation: Apply according to ASTM C1015 and manufacturer's written instructions.
 - i Level horizontal applications to uniform thickness as indicated, lightly settle to uniform density, but do not compact excessively.
 - ii For cellulosic-fiber loose-fill insulation, comply with CIMA's Bulletin #2, "Standard Practice for Installing Cellulose Insulation."
- d. Spray-Applied Cellulosic Insulation: Apply spray-applied insulation according to manufacturer's written instructions.
 - i Do not apply insulation until installation of pipes, ducts, conduits, wiring, and electrical outlets in walls is completed and windows, electrical boxes, and other items not indicated to receive insulation are masked.
 - ii After insulation is applied, make flush with face of studs by using method recommended by insulation manufacturer.

7. INSTALLATION OF CURTAIN-WALL INSULATION

- a. Install board insulation in curtain-wall construction according to curtain-wall manufacturer's written instructions.
 - i Hold insulation in place by securing metal clips and straps or integral pockets within window frames, spaced at intervals recommended in writing by insulation manufacturer to hold insulation securely in place without touching spandrel glass.
 - ii Maintain cavity width of dimension indicated on Drawings between insulation and glass.
 - iii install insulation to fit snugly without bowing.

8. INSTALLATION OF REFLECTIVE INSULATION

- a. Install sheet reflective insulation according to ASTM C727.
- b. Install sheet radiant barriers according to ASTM C1744.
- c. Install interior radiation control coating system according to ASTM C1321.

9. PROTECTION

- a. Protect installed insulation from damage due to harmful weather exposures, physical abuse, and other causes.
- b. Provide temporary coverings or enclosures where insulation is subject to abuse and cannot be concealed and protected by permanent construction immediately after installation.

D Measurement

The department will measure all Gypsum Board Partitions and Assemblies as a single unit for each project, acceptably completed.

E Payment

The department will pay for measured quantities at the contract unit price under the following bid item:

ITEM NUMBER	DESCRIPTION	UNIT
SPV.0060.26	Gypsum Board Partitions and Assemblies	EACH

Payment is full compensation for furnishing and installation of all gypsum board partitions in the project.

47. Ceilings, Item SPV.0060.27.

A Description

A.1 SUMMARY

- a. Section includes Acoustical Metal panels ceilings and associated suspension systems
- b. Gypsum board ceilings
- c. Products furnished, but not installed under this Section, include anchors, clips, and other ceiling attachment devices to be cast in concrete.

A.2 PREINSTALLATION MEETINGS

- a. Preinstallation Conference: Conduct conference at Project site.

A.3 ACTION SUBMITTALS

- a. Product Data: For each type of product.
- b. Samples: For each exposed product and for each color and texture specified, 6 inches (150 mm) in size.
- c. Samples for Initial Selection: For components with factory-applied finishes.
- d. Samples for Verification: For each component indicated and for each exposed finish required, prepared on Samples of sizes indicated below:
 - i Acoustical Panels: Set of full-size 6-inch- (150-mm-) square samples of each type, color, pattern, and texture.
 - ii Exposed Suspension-System Members, Moldings, and Trim: Set of 6-inch- (150-mm-) long Samples of each type, finish, and color.
 - iii Clips: Full-size hold-down impact and seismic clips.
- e. Delegated-Design Submittal: For seismic restraints for ceiling systems.
 - i Include design calculations for seismic restraints including analysis data signed and sealed by the qualified professional engineer responsible for their preparation.

A.4 INFORMATIONAL SUBMITTALS

- a. Coordination Drawings: Reflected ceiling plans, drawn to scale, on which the following items are shown and coordinated with each other, using input from installers of the items involved:
 - i Ceiling suspension-system members.
 - ii Structural members to which suspension systems will be attached.
 - iii Method of attaching hangers to building structure.
 - 1) Furnish layouts for cast-in-place anchors, clips, and other ceiling attachment devices whose installation is specified in other Sections.
 - iv Carrying channels or other supplemental support for hanger-wire attachment where conditions do not permit installation of hanger wires at required spacing.
 - v Size and location of initial access modules for acoustical panels.
 - vi Items penetrating finished ceiling and ceiling-mounted items including the following:
 - 1) Lighting fixtures.
 - 2) Diffusers.
 - 3) Grilles.
 - 4) Speakers.
 - 5) Sprinklers.
 - 6) Access panels.
 - 7) Perimeter moldings.
 - vii Show operation of hinged and sliding components covered by or adjacent to acoustical panels.
 - viii Minimum Drawing Scale: 1/4 inch = 1 foot (1:48)
- b. Qualification Data: For testing agency.
- c. Product Test Reports: For each acoustical panel ceiling, for tests performed by manufacturer and witnessed by a qualified testing agency a qualified testing agency.
- d. Evaluation Reports: For each acoustical panel ceiling suspension system and anchor and fastener type, from ICC-ES.
- e. Field quality-control reports.

A.5 CLOSEOUT SUBMITTALS

- a. Maintenance Data: For finishes to include in maintenance manuals.

A.6 MAINTENANCE MATERIAL SUBMITTALS

- a. Furnish extra materials, from the same product run, that match products installed and that are packaged with protective covering for storage and identified with labels describing contents.
 - i Acoustical Ceiling Units: Full-size panels equal to 2 percent of quantity installed.
 - ii Suspension-System Components: Quantity of each exposed component equal to 2 percent of quantity installed.
 - iii Hold-Down Clips: Equal to 2 percent of quantity installed.
 - iv Impact Clips: Equal to 2 percent of quantity installed.

A.7 QUALITY ASSURANCE

- a. Mockups: Build mockups to verify selections made under Sample submittals, to demonstrate aesthetic effects, and to set quality standards for materials and execution.
 - i Build mockup of typical ceiling area as shown on Drawings.

- ii Approval of mockups does not constitute approval of deviations from the Contract Documents contained in mockups unless Architect specifically approves such deviations in writing.
- iii Subject to compliance with requirements, approved mockups may become part of the completed Work if undisturbed at time of Substantial Completion.

A.8 DELIVERY, STORAGE, AND HANDLING

- a. Deliver acoustical panels, suspension-system components, and accessories to Project site and store them in a fully enclosed, conditioned space where they will be protected against damage from moisture, humidity, temperature extremes, direct sunlight, surface contamination, and other causes.
- b. Before installing acoustical panels, permit them to reach room temperature and a stabilized moisture content.

A.9 FIELD CONDITIONS

- a. Environmental Limitations: Do not install acoustical panel ceilings until spaces are enclosed and weathertight, wet-work in spaces is complete and dry, work above ceilings is complete, and ambient temperature and humidity conditions are maintained at the levels indicated for Project when occupied for its intended use.
 - i Pressurized Plenums: Operate ventilation system for not less than 48 hours before beginning acoustical panel ceiling installation.

B Materials

B.1 MANUFACTURERS

- a. Source Limitations: Obtain each type of acoustical ceiling panel and its supporting suspension system from single source from single manufacturer.

B.2 PERFORMANCE REQUIREMENTS

- a. Delegated Design: Engage a qualified professional engineer, as defined in Section "Quality Requirements," to design seismic restraints for ceiling systems.
- b. Seismic Performance: Suspended ceilings shall withstand the effects of earthquake motions determined according to ASCE/SEI 7.
- c. Surface-Burning Characteristics: Comply with ASTM E84; testing by a qualified testing agency. Identify products with appropriate markings of applicable testing agency.
 - i Flame-Spread Index: Class A B C according to ASTM E1264.
 - ii Smoke-Developed Index: 50 450 or less.
 - iii Indicate design designations from UL or from the listings of another qualified testing agency.

B.3 ACOUSTICAL PANELS

- a. Armstrong Metal Works for Designflex Tegular or approved equal
- b. Acoustical Panel Standard: Provide manufacturer's standard panels according to ASTM E1264 and designated by type, form, pattern, acoustical rating, and light reflectance unless otherwise indicated.

B.3.1.2 Sheet Metal Characteristics: For metal components exposed to view in the completed Work, provide materials with smooth, flat surfaces without blemishes. Do not use materials with exposed pitting, seam marks, roller marks, roughness, stains, or discolorations.

- a. Aluminum Sheet: Rolled aluminum sheet, complying with ASTM B209 (ASTM B209M); alloy and temper recommended by aluminum producer and finisher for type of use and finish indicated.

- b. Steel Sheet: Commercial-quality, cold-rolled, carbon-steel sheet; stretcher leveled; with protective coating complying with ASTM C635/C635M.
- c. Painted Finishes: Electrolytic zinc-coated steel complying with ASTM A879/A879M, 13Z (40G) coating, surface treatment as recommended by finish manufacturer for type of use and finish indicated.
- d. Chemical/Mechanical Finishes: Uncoated steel sheet complying with ASTM A1008/A1008M with luster or bright finish as required by finisher for applying electroplating or other metallic-finishing processes.
- e. Light Reflectance (LR): Not less than LR indicated in a schedule 0.75
- f. Ceiling Attenuation Class (CAC): Not less than CAC indicated in a schedule 30.
- g. Noise Reduction Coefficient (NRC): Not less than NRC 0.55
- h. Articulation Class (AC): Not less than AC indicated in a schedule 190.
- i. Edge/Joint Detail: Square Reveal sized to fit flange of exposed suspension-system members
Flush reveal sized to fit flange of exposed suspension-system members Beveled, kerfed, and rabbeted long edges and square, butt-on short edges As indicated by manufacturer's designation.
- j. Thickness: 5/8 inch (15 mm) 3/4 inch (19 mm) 7/8 inch (22 mm) As indicated on Drawings As indicated in a schedule.
- k. Thickness: 1/8 inch (3 mm) 7/16 inch (12 mm) 9/16 inch (15 mm) 5/8 inch (15 mm) 3/4 inch (19 mm) 7/8 inch (22 mm) 1 inch (25 mm) 1-1/2 inches (38 mm) 2 inches (51 mm) 3 inches (76 mm) As indicated on Drawings As indicated in a schedule.
- l. Modular Size: 24 by 24 inches (610 by 610 mm) 24 by 48 inches (610 by 1220 mm)

B.4 METAL SUSPENSION SYSTEM

- a. Manufacturers: Armstrong Metal Works for designflex Tegular or approved equal..
- b. Narrow-Face, Uncapped, Double-Web, Steel Suspension System: Main and cross runners roll formed from cold-rolled steel sheet; prepainted, electrolytically zinc coated, or hot-dip galvanized, G30 (Z90) coating designation; to produce structural members with 5/16-inch- (15-mm-) wide faces.
 - i Structural Classification: Intermediate Heavy-duty system.
 - ii Face Design: With 1/8-inch- (3-mm-) wide, slotted, box-shaped flange With 1/4-inch- (6-mm-) wide, slotted, box-shaped flange Flanges formed in stepped design with a center protrusion projecting 19/64 inch (7.54 mm) below flange surfaces supporting panel faces and forming 3/16-inch- (4.76-mm-) wide reveals between edges of protrusion and those of panels.
 - iii Face Finish: Painted white in color as selected from manufacturer's full range to match color indicated by manufacturer's designation to match color of acoustical unit.
 - iv Reveal Finish: Painted to match flange color white black in color other than flange color as selected from manufacturer's full range of contrasting reveal colors.

B.5 ACCESSORIES

- a. Attachment Devices: Size for five times the design load indicated in ASTM C635/C635M, Table 1, "Direct Hung," unless otherwise indicated. Comply with seismic design requirements.
- b. Wire Hangers, Braces, and Ties: Provide wires as follows:
 - i Zinc-Coated, Carbon-Steel Wire: ASTM A641/A641M, Class 1 zinc coating, soft temper.
 - ii Size: Wire diameter sufficient for its stress at three times hanger design load (ASTM C635/C635M, Table 1, "Direct Hung") will be less than yield stress of wire, but not less than 0.106-inch- (2.69-mm-) 0.135-inch- (3.5-mm-) diameter wire.

- c. Hanger Rods: Mild steel, zinc coated or protected with rust-inhibitive paint.
- d. Flat Hangers: Mild steel, zinc coated or protected with rust-inhibitive paint.
- e. Angle Hangers: Angles with legs not less than 7/8 inch (22 mm) wide; formed with 0.04-inch- (1-mm-) thick, galvanized-steel sheet complying with ASTM A653/A653M, G90 (Z275) coating designation; with bolted connections and 5/16-inch- (8-mm-) diameter bolts.
- f. Hold-Down Clips: Manufacturer's standard hold-down.
- g. Impact Clips: Manufacturer's standard impact-clip system designed to absorb impact forces against acoustical panels.
- h. Seismic Clips: Manufacturer's standard seismic clips designed to secure acoustical panels in place during a seismic event.
- i. Seismic Stabilizer Bars: Manufacturer's standard perimeter stabilizers designed to accommodate seismic forces.
- j. Seismic Struts: Manufacturer's standard compression struts designed to accommodate seismic forces.
- k. Clean-Room Gasket System: Where indicated, provide manufacturer's standard system, including manufacturer's standard closed-cell PVC neoprene antimicrobial gasket and related adhesives, tapes, seals, and retention clips, designed to seal out foreign material from and maintain positive pressure in clean room.

B.6 METAL EDGE MOLDINGS AND TRIM

- a. Manufacturer: Armstrong, Metal Works for designflex Tegular or approved equal
- b. Roll-Formed, Sheet-Metal Edge Moldings and Trim: Type and profile indicated or, if not indicated, manufacturer's standard moldings for edges and penetrations that comply with seismic design requirements; formed from sheet metal of same material, finish, and color as that used for exposed flanges of suspension-system runners.
 - i. Edge moldings shall fit acoustical panel edge details and suspension systems indicated and match width and configuration of exposed runners unless otherwise indicated.
 - ii. For lay-in panels with reveal edge details, provide stepped edge molding that forms reveal of same depth and width as that formed between edge of panel and flange at exposed suspension member.
 - iii. For circular penetrations of ceiling, provide edge moldings fabricated to diameter required to fit penetration exactly.
- c. Extruded-Aluminum Edge Moldings and Trim: Where indicated, provide manufacturer's extruded-aluminum edge moldings and trim of profile indicated or referenced by manufacturer's designations, including splice plates, corner pieces, and attachment and other clips, complying with seismic design requirements.
 - i. Clear Anodic Finish: AAMA 611, AA-M12C22A31, Class II, 0.010 mm or thicker.
 - ii. Baked-Enamel or Powder-Coat Finish: Minimum dry film thickness of 1.5 mils (0.04 mm). Comply with ASTM C635/C635M and coating manufacturer's written instructions for cleaning, conversion coating, and applying and baking finish.

B.7 ACOUSTICAL SEALANT

C Construction

- a. Examine substrates, areas, and conditions, including structural framing to which acoustical panel ceilings attach or abut, with Installer present, for compliance with requirements specified in this and other Sections that affect ceiling installation and anchorage and with requirements for installation tolerances and other conditions affecting performance of acoustical panel ceilings.

- b. Examine acoustical panels before installation. Reject acoustical panels that are wet, moisture damaged, or mold damaged.
- c. Proceed with installation only after unsatisfactory conditions have been corrected.

C.2 PREPARATION

- a. Measure each ceiling area and establish layout of acoustical panels to balance border widths at opposite edges of each ceiling. Avoid using less-than-half-width panels at borders unless otherwise indicated and comply with layout shown on reflected ceiling plans.
- b. Layout openings for penetrations centered on the penetrating items.
- c. Install acoustical panel ceilings according to ASTM C636/C636M, seismic design requirements, and manufacturer's written instructions.
 - i. **Fire-Rated Assembly:** Install fire-rated ceiling systems according to tested fire-rated design.
- d. Suspend ceiling hangers from building's structural members and as follows:
 - i. Install hangers plumb and free from contact with insulation or other objects within ceiling plenum that are not part of supporting structure or of ceiling suspension system.
 - ii. Splay hangers only where required and, if permitted with fire-resistance-rated ceilings, to miss obstructions; offset resulting horizontal forces by bracing, countersplaying, or other equally effective means.
 - iii. Where width of ducts and other construction within ceiling plenum produces hanger spacings that interfere with location of hangers at spacings required to support standard suspension-system members, install supplemental suspension members and hangers in form of trapezes or equivalent devices.
 - iv. Secure wire hangers to ceiling-suspension members and to supports above with a minimum of three tight turns. Connect hangers directly to structure or to inserts, eye screws, or other devices that are secure and appropriate for substrate and that will not deteriorate or otherwise fail due to age, corrosion, or elevated temperatures.
 - v. Secure flat, angle, channel, and rod hangers to structure, including intermediate framing members, by attaching to inserts, eye screws, or other devices that are secure and appropriate for both the structure to which hangers are attached and the type of hanger involved. Install hangers in a manner that will not cause them to deteriorate or fail due to age, corrosion, or elevated temperatures.
 - vi. Do not support ceilings directly from permanent metal forms or floor deck. Fasten hangers to cast-in-place hanger inserts, postinstalled mechanical or adhesive anchors, or power-actuated fasteners that extend through forms into concrete.
 - vii. When steel framing does not permit installation of hanger wires at spacing required, install carrying channels or other supplemental support for attachment of hanger wires.
 - viii. Do not attach hangers to steel deck tabs.
 - ix. Do not attach hangers to steel roof deck. Attach hangers to structural members.
 - x. Space hangers not more than 48 inches (1200 mm) o.c. along each member supported directly from hangers unless otherwise indicated; provide hangers not more than 8 inches (200 mm) from ends of each member.
 - xi. Size supplemental suspension members and hangers to support ceiling loads within performance limits established by referenced standards.
- e. Install edge moldings and trim of type indicated at perimeter of acoustical ceiling area and where necessary to conceal edges of acoustical panels.
 - i. Apply acoustical sealant in a continuous ribbon concealed on back of vertical legs of moldings before they are installed.

- ii Screw attach moldings to substrate at intervals not more than 16 inches (400 mm) o.c. and not more than 3 inches (75 mm) from ends. Miter corners accurately and connect securely.
- iii Do not use exposed fasteners, including pop rivets, on moldings and trim.
- f. Install suspension-system runners so they are square and securely interlocked with one another. Remove and replace dented, bent, or kinked members.
- g. Install acoustical panels with undamaged edges and fit accurately into suspension-system runners and edge moldings. Scribe and cut panels at borders and penetrations to provide precise fit.
 - i Arrange directionally patterned acoustical panels as follows:
 - 1) As indicated on reflected ceiling plans.
 - 2) Install panels with pattern running in one direction parallel to long short axis of space.
 - 3) Install panels in a basket-weave pattern.
 - ii For square-edged panels, install panels with edges fully hidden from view by flanges of suspension-system runners and moldings.
 - iii For reveal-edged panels on suspension-system runners, install panels with bottom of reveal in firm contact with top surface of runner flanges.
 - iv For reveal-edged panels on suspension-system members with box-shaped flanges, install panels with reveal surfaces in firm contact with suspension-system surfaces and panel faces flush with bottom face of runners.
 - v Paint cut edges of panel remaining exposed after installation; match color of exposed panel surfaces using coating recommended in writing for this purpose by acoustical panel manufacturer.
 - vi Install hold-down impact and seismic clips in areas indicated; space according to panel manufacturer's written instructions unless otherwise indicated.
 - 1) Hold-Down Clips: Space 24 inches (610 mm) o.c. on all cross runners.
 - vii Install clean-room gasket system in areas indicated, sealing each panel and fixture as recommended by panel manufacturer's written instructions.
 - viii Protect lighting fixtures and air ducts according to requirements indicated for fire-resistance-rated assembly.

C.3 ERECTION TOLERANCES

- a. Suspended Ceilings: Install main and cross runners level to a tolerance of 1/8 inch in 12 feet (3 mm in 3.6 m), non-cumulative.
- b. Moldings and Trim: Install moldings and trim to substrate and level with ceiling suspension system to a tolerance of 1/8 inch in 12 feet (3 mm in 3.6 m), non-cumulative.

C.4 FIELD QUALITY CONTROL

- a. Special Inspections: Engage a qualified special inspector to perform the following special inspections:
 - i Periodic inspection during the installation of suspended ceiling grids according to ASCE/SEI 7.
- b. Testing Agency: Engage a qualified testing agency to perform tests and inspections.
- c. Perform the following tests and inspections of completed installations of acoustical panel ceiling hangers and anchors and fasteners in successive stages and when installation of ceiling suspension systems on each floor has reached 20 percent completion, but no panels have been installed. Do not proceed with installations of acoustical panel ceiling hangers for

the next area until test results for previously completed installations of acoustical panel ceiling hangers show compliance with requirements.

- i Within each test area, testing agency will select one of every 10 power-actuated fasteners and postinstalled anchors used to attach hangers to concrete and will test them for 200 lbf (890 N) of tension; it will also select one of every two postinstalled anchors used to attach bracing wires to concrete and will test them for 440 lbf (1957 N) of tension.
 - ii When testing discovers fasteners and anchors that do not comply with requirements, testing agency will test those anchors not previously tested until 20 pass consecutively and then will resume initial testing frequency.
- d. Acoustical panel ceiling hangers, anchors, and fasteners will be considered defective if they do not pass tests and inspections.
 - e. Prepare test and inspection reports.

C.5 CLEANING

- a. Clean exposed surfaces of acoustical panel ceilings, including trim, edge moldings, and suspension-system members. Comply with manufacturer's written instructions for cleaning and touchup of minor finish damage.
- b. Remove and replace ceiling components that cannot be successfully cleaned and repaired to permanently eliminate evidence of damage.

D Measurement

The department will measure Ceilings as a single unit for each project, acceptably completed.

E Payment

The department will pay for measured quantities at the contract unit price under the following bid item:

ITEM NUMBER	DESCRIPTION	UNIT
SPV.0060.27	Ceilings	EACH

Payment is full compensation for furnishing and installation of all ceilings in the project.

48. Interior and Exterior Signage, Item SPV.0060.28.

A Description

A.1 Related Documents

- 1. Drawings, specifications and general provisions of the contract.

A.2 Section Includes

- 1. Room and door signs.
- 2. Interior directional and informational signs.
- 3. Amtrak Station Identification Signage
- 4. Building identification signs.
- 5. Traffic signs.

A.3 References

- 1. Amtrak Graphic Signage Standards Manual, rev. August 25, 2015.

A.4 Submittals

1. Signage Schedule: Provide information sufficient to completely define each sign for fabrication, including room number, room name, other text to be applied, sign and letter sizes, fonts, and colors.
 - a. When content of signs is indicated to be determined later, request such information from Amtrak through engineer at least 2 months prior to start of fabrication; upon request, submit preliminary schedule.
 - b. Submit for approval by Amtrak through engineer prior to fabrication.
2. Manufacturer's Installation Instructions: Include installation templates and attachment devices.

A.5 Quality Assurance

1. Manufacturer Qualifications: Company specializing in manufacturing the products specified in this section with minimum three years of documented experience.

A.6 Delivery, Storage, and Handling

1. Package signs as required to prevent damage before installation.
2. Store tape adhesive at normal room temperature.

A.7 Field Conditions

1. Do not install tape adhesive when ambient temperature is lower than recommended by manufacturer.
2. Maintain this minimum temperature during and after installation of signs.

B Materials

B.1 Manufacturers

1. Any manufacturer in compliance with the Amtrak signage standards given in the Drawings is acceptable.

B.2 Signage Applications

1. Accessibility Compliance: Signs are required to comply with ADA Standards and ICC A117.1 and applicable building codes, unless otherwise indicated; in the event of conflicting requirements, comply with the most comprehensive and specific requirements.
2. Room and Door Signs: Provide a sign for every doorway, whether it has a door or not, not including corridors, lobbies, and similar open areas.
3. Provide and install signs as shown and scheduled in the Drawing set.
4. Sign Type: Flat signs with engraved panel media as specified.
5. Provide "tactile" signage, with letters raised minimum 1/32 inch and Grade II braille.
6. Building Identification Signs:
 - a. Mount in locations as shown on drawings.

B.3 Tactile Signage Media

1. Photopolymer Panels: Exterior grade, with painted field, letters and braille, and silkscreened symbol.
 - a. Total Thickness: 1/4 inch.

C Construction

C.1 Examination

1. Verify that substrate surfaces are ready to receive work.

C.2 Installation

1. Install according to manufacturer's instructions.
2. Install neatly, with horizontal edges level.
3. Locate signs where indicated. If no location is indicated obtain Amtrak's instructions.
4. Protect from damage until Substantial Completion; repair or replace damage items.

D Measurement

The department will measure Interior and Exterior Signage as a single unit for each project, acceptably completed.

E Payment

The department will pay for measured quantities at the contract unit price under the following bid item:

ITEM NUMBER	DESCRIPTION	UNIT
SPV.0060.28	Interior and Exterior Signage	EACH

Payment is full compensation for furnishing and installation of signage in the project.

49. Other Architectural Work, Item SPV.0060.29.

A Description

This special provision describes providing all other architectural work for the project not specifically covered in other sections of the specification.

A.1 Section Includes:

1. Cold-applied, emulsified-asphalt dampproofing.
2. Self-adhering, vapor-retarding, nonbituminous sheet air barriers.
3. Self-adhering, vapor-permeable, nonbituminous sheet air barriers.
4. Penetrations in fire-resistance-rated walls.
5. Penetrations in horizontal assemblies.
6. Joints in or between fire-resistance-rated constructions.
7. Joints at exterior curtain-wall/floor intersections.
8. Silicone joint sealants.
9. Nonstaining silicone joint sealants.
10. Urethane joint sealants.
11. Silane-modified polymer joint sealants.
12. Latex joint sealants.

A.2 Bituminous Dampproofing

A.2.1 SUMMARY

1. Section Includes:
 - a. Cold-applied, emulsified-asphalt dampproofing.

2. Related Requirements:
 - a. "Cast-in-Place Concrete" for bituminous vapor retarders under slabs-on-grade.
 - b. "Unit Masonry" for mortar parge coat on masonry surfaces.
 - c. "Cold Fluid-Applied Waterproofing" for waterproofing.

A.2.2 ACTION SUBMITTALS

1. Product Data: For each type of product.

A.2.3 FIELD CONDITIONS

1. Weather Limitations: Proceed with application only when existing and forecasted weather conditions permit dampproofing to be performed according to manufacturers' written instructions.
2. Ventilation: Provide adequate ventilation during application of dampproofing in enclosed spaces. Maintain ventilation until dampproofing has cured.

A.3 Non-bituminous Self-Adhering Sheet Air Barriers

A.3.1 RELATED DOCUMENTS

1. Drawings and general provisions of the Contract, including General and Supplementary Conditions, apply to this Section.

A.3.2 SUMMARY

1. Section Includes:
 - a. Self-adhering, vapor-retarding, nonbituminous sheet air barriers.
 - b. Self-adhering, vapor-permeable, nonbituminous sheet air barriers.
2. Related Requirements:
 - a. "Sheathing" for wall sheathings and wall sheathing joint-and-penetration treatments.

A.3.3 DEFINITIONS

1. Air-Barrier Material: A primary element that provides a continuous barrier to the movement of air.
2. Air-Barrier Accessory: A transitional component of the air barrier that provides continuity.
3. Air-Barrier Assembly: The collection of air-barrier materials and accessories applied to an opaque wall, including joints and junctions to abutting construction, to control air movement through the wall.

A.3.4 PREINSTALLATION MEETINGS

1. Preinstallation Conference: Conduct conference at Project site.
 - a. Review air-barrier requirements and installation, special details, mockups, air-leakage and bond testing, air-barrier protection, and work scheduling that covers air barriers.

A.3.5 ACTION SUBMITTALS

1. Product Data: For each type of product.
 - a. Include manufacturer's written instructions for evaluating, preparing, and treating each substrate; technical data; and tested physical and performance properties of products.
2. Sustainable Design Submittals:
3. Shop Drawings: For air-barrier assemblies.
 - a. Show locations and extent of air-barrier materials, accessories, and assemblies specific to Project conditions.
 - b. Include details for substrate joints and cracks, counterflashing strips, penetrations, inside and outside corners, terminations, and tie-ins with adjoining construction.
 - c. Include details of interfaces with other materials that form part of air barrier.

A.3.6 INFORMATIONAL SUBMITTALS

1. Qualification Data: For Installer. Include list of ABAA-certified installers and supervisors employed by Installer, who work on Project.
2. Product Certificates: From air-barrier manufacturer, certifying compatibility of air barriers and accessory materials with Project materials that connect to or that come in contact with air barrier.
3. Product Test Reports: For each air-barrier assembly, for tests performed by a qualified testing agency.
4. Field quality-control reports.

A.3.7 QUALITY ASSURANCE

1. Installer Qualifications: An entity that employs installers and supervisors who are trained and approved by manufacturer.
 - a. Installer shall be licensed by ABAA according to ABAA's Quality Assurance Program and shall employ ABAA-certified installers and supervisors on Project.
2. Mockups: Build mockups to set quality standards for materials and execution and for preconstruction testing.
 - a. Build integrated mockups of exterior wall assembly as indicated on Drawings, 150 sq. feet. (14 sq. m) incorporating backup wall construction, external cladding, window, storefront, door frame and sill, insulation, ties and other penetrations, and flashing to demonstrate surface preparation, crack and joint treatment, application of air barriers, and sealing of gaps, terminations, and penetrations of air-barrier assembly.
 - i. Coordinate construction of mockups to permit inspection and testing of air barrier before external insulation and cladding are installed.
 - ii. Include junction with roofing membrane, building corner condition, and foundation wall intersection.
 - iii. If Architect determines mockups do not comply with requirements, reconstruct mockups and apply air barrier until mockups are approved.
 - b. Approval of mockups does not constitute approval of deviations from the Contract Documents contained in mockups unless Architect specifically approves such deviations in writing.
 - c. Subject to compliance with requirements, approved mockups may become part of the completed Work if undisturbed at time of Substantial Completion.

A.3.8 PRECONSTRUCTION TESTING

1. Preconstruction Testing Service: Owner will engage Engage a qualified testing agency to perform preconstruction testing on field mockups.
2. Mockup Testing: Air-barrier assemblies shall comply with performance requirements indicated, as evidenced by reports based on mockup testing by a qualified testing agency.
 - a. Air-Leakage-Location Testing: Mockups will be tested for evidence of air leakage according to ASTM E1186, chamber pressurization or depressurization with smoke tracers
ASTM E1186, chamber depressurization with detection liquids.
 - b. Air-Leakage-Volume Testing: Mockups will be tested for air-leakage rate according to ASTM E783 or ASTM E2357.
 - c. Adhesion Testing: Mockups will be tested for required air-barrier adhesion to substrate according to ASTM D4541.
 - d. Notify Architect seven days in advance of the dates and times when mockups will be tested.

A.3.9 DELIVERY, STORAGE, AND HANDLING

1. Remove and replace liquid materials that cannot be applied within their stated shelf life.
2. Protect stored materials from direct sunlight.

A.3.10 FIELD CONDITIONS

1. Environmental Limitations: Apply air barrier within the range of ambient and substrate temperatures recommended in writing by air-barrier manufacturer.
 - a. Protect substrates from environmental conditions that affect air-barrier performance.
 - b. Do not apply air barrier to a damp or wet substrate or during snow, rain, fog, or mist.

A.4 Penetration Firestopping

A.4.1 SUMMARY

1. Section Includes:
 - a. Penetrations in fire-resistance-rated walls.
 - b. Penetrations in horizontal assemblies.
 - c. Penetrations in smoke barriers.
2. Related Requirements:
 - a. "Joint Firestopping" for joints in or between fire-resistance-rated construction, at exterior curtain-wall/floor intersections, and in smoke barriers.

A.4.2 ACTION SUBMITTALS

1. Product Data: For each type of product.
2. Product Schedule: For each penetration firestopping system. Include location, illustration of firestopping system, and design designation of qualified testing and inspecting agency.
 - a. Engineering Judgments: Where project conditions require modification to a qualified testing and inspecting agency's illustration for a particular penetration firestopping system, submit illustration, with modifications marked, approved by penetration firestopping system manufacturer's fire-protection engineer as an engineering judgment or equivalent fire-resistance-rated assembly developed according to current International Firestop Council (IFC) guidelines. Obtain approval of authorities having jurisdiction prior to submittal.

A.4.3 INFORMATIONAL SUBMITTALS

1. Qualification Data: For Installer.
2. Listed System Designs: For each penetration firestopping system, for tests performed by a qualified testing agency.

A.4.4 CLOSEOUT SUBMITTALS

1. Installer Certificates: From Installer indicating that penetration firestopping systems have been installed in compliance with requirements and manufacturer's written instructions.

A.4.5 QUALITY ASSURANCE

1. Installer Qualifications: A firm that has been approved by FM Approvals according to FM Approvals 4991, "Approval Standard for Firestop Contractors," or been evaluated by UL and found to comply with its "Qualified Firestop Contractor Program Requirements."

A.4.6 PROJECT CONDITIONS

1. Environmental Limitations: Do not install penetration firestopping system when ambient or substrate temperatures are outside limits permitted by penetration firestopping system manufacturers or when substrates are wet because of rain, frost, condensation, or other causes.
2. Install and cure penetration firestopping materials per manufacturer's written instructions using natural means of ventilations or, where this is inadequate, forced-air circulation.

A.4.7 COORDINATION

1. Coordinate construction of openings and penetrating items to ensure that penetration firestopping systems can be installed according to specified firestopping system design.

2. Coordinate sizing of sleeves, openings, core-drilled holes, or cut openings to accommodate penetration firestopping systems.

A.5 Joint Firestopping

A.5.1 SUMMARY

1. Section Includes:
 - a. Joints in or between fire-resistance-rated constructions.
 - b. Joints at exterior curtain-wall/floor intersections.
 - c. Joints in smoke barriers.
2. Related Requirements:
 - a. "Penetration Firestopping" for penetrations in fire-resistance-rated walls, horizontal assemblies, and smoke barriers and for wall identification.

A.5.2 PREINSTALLATION MEETINGS

1. Preinstallation Conference: Conduct conference at project site.

A.5.3 ACTION SUBMITTALS

1. Product Data: For each type of product.
2. Sustainable Design Submittals:
3. Product Schedule: For each joint firestopping system. Include location, illustration of firestopping system, and design designation of qualified testing agency.
 - a. Engineering Judgments: Where project conditions require modification to a qualified testing agency's illustration for a particular joint firestopping system condition, submit illustration, with modifications marked, approved by joint firestopping system manufacturer's fire-protection engineer as an engineering judgment or equivalent fire-resistance-rated assembly developed according to current International Firestop Council (IFC) guidelines.

A.5.4 INFORMATIONAL SUBMITTALS

1. Qualification Data: For Installer.
2. Listed System Designs: For each joint firestopping system, for tests performed by a qualified testing agency.

A.5.5 CLOSEOUT SUBMITTALS

1. Installer Certificates: From Installer indicating that joint firestopping systems have been installed in compliance with requirements and manufacturer's written instructions.

A.5.5.2 QUALITY ASSURANCE

1. Installer Qualifications: A firm that has been approved by FM Approvals according to FM Approvals 4991, "Approval of Firestop Contractors," or been evaluated by UL and found to comply with UL's "Qualified Firestop Contractor Program Requirements."

A.5.6 PROJECT CONDITIONS

1. Environmental Limitations: Do not install joint firestopping systems when ambient or substrate temperatures are outside limits permitted by joint firestopping system manufacturers or when substrates are wet due to rain, frost, condensation, or other causes.
2. Install and cure joint firestopping systems per manufacturer's written instructions using natural means of ventilation or, where this is inadequate, forced-air circulation.

A.5.7 COORDINATION

1. Coordinate construction of joints to ensure that joint firestopping systems can be installed according to specified firestopping system design.
2. Coordinate sizing of joints to accommodate joint firestopping systems.

A.6 Joint Sealants

A.6.1 SUMMARY

1. Section Includes:
 - a. Silicone joint sealants.
 - b. Nonstaining silicone joint sealants.
 - c. Urethane joint sealants.
 - d. Silane-modified polymer joint sealants.
 - e. Latex joint sealants.
2. Related Requirements:
 - a. Section "Preformed Joint Seals" for preformed compressible foam and precured joint seals.
 - b. Section "Concrete Paving Joint Sealants" for sealing joints in paved roads, parking lots, walkways, and curbing.

A.6.2 PREINSTALLATION MEETINGS

1. Preinstallation Conference: Conduct conference at Project site.

A.6.3 ACTION SUBMITTALS

1. Product Data:
 - a. Joint sealants.
 - b. Joint-sealant backing materials.
2. Samples for Initial Selection: Manufacturer's standard color charts consisting of strips of cured sealants showing the full range of colors available for each product exposed to view.
3. Samples for Verification: For each type and color of joint sealant required, provide Samples with joint sealants in 1/2-inch- (13-mm-) wide joints formed between two 6-inch- (150-mm-) long strips of material matching the appearance of exposed surfaces adjacent to joint sealants.
4. Joint-Sealant Schedule: Include the following information:
 - a. Joint-sealant application, joint location, and designation.
 - b. Joint-sealant manufacturer and product name.
 - c. Joint-sealant formulation.
 - d. Joint-sealant color.

A.6.4 INFORMATIONAL SUBMITTALS

1. Preconstruction Laboratory Test Schedule: Include the following information for each joint sealant and substrate material to be tested:
 - a. Joint-sealant location and designation.
 - b. Manufacturer and product name.
 - c. Type of substrate material.
 - d. Proposed test.
 - e. Number of samples required.
2. Preconstruction Laboratory Test Reports: For each joint sealant and substrate material to be tested from sealant manufacturer, indicating the following:
 - a. Materials forming joint substrates and joint-sealant backings have been tested for compatibility and adhesion with joint sealants.
 - b. Interpretation of test results and written recommendations for primers and substrate preparation are needed for adhesion.

3. Preconstruction Field-Adhesion-Test Reports: Indicate which sealants and joint preparation methods resulted in optimum adhesion to joint substrates based on testing specified in "Preconstruction Testing" Article.
4. Field Quality-Control Reports: For field-adhesion-test reports, for each sealant application tested.
5. Sample warranties.

A.6.5 CLOSEOUT SUBMITTALS

1. Manufacturers' special warranties.
2. Installer's special warranties.

A.6.6 QUALITY ASSURANCE

1. Installer Qualifications: Authorized representative who is trained and approved by manufacturer.
2. Testing Agency Qualifications: Qualified according to ASTM C1021 to conduct the testing indicated.

A.6.7 MOCKUPS

1. Install sealant in mockups of assemblies specified in other Sections that are indicated to receive joint sealants specified in this Section. Use materials and installation methods specified in this Section.

A.6.8 PRECONSTRUCTION TESTING

1. Preconstruction Laboratory Testing: Submit to joint-sealant manufacturers, for testing indicated below, samples of materials that will contact or affect joint sealants.
 - a. Adhesion Testing: Use ASTM C794 to determine whether priming and other specific joint preparation techniques are required to obtain rapid, optimum adhesion of joint sealants to joint substrates.
 - b. Compatibility Testing: Use ASTM C1087 to determine sealant compatibility when in contact with glazing and gasket materials.
 - c. Stain Testing: Use ASTM C1248 to determine stain potential of sealant when in contact with stone masonry substrates.
 - d. Submit manufacturer's recommended number of pieces of each type of material, including joint substrates, joint-sealant backings, and miscellaneous materials.
 - e. Schedule sufficient time for testing and analyzing results to prevent delaying the Work.
 - f. For materials failing tests, obtain joint-sealant manufacturer's written instructions for corrective measures, including use of specially formulated primers.
 - g. Testing will not be required if joint-sealant manufacturers submit data that are based on previous testing, not older than 24 months, of sealant products for adhesion to, staining of, and compatibility with joint substrates and other materials matching those submitted.
2. Preconstruction Field-Adhesion Testing: Before installing sealants, field test their adhesion to Project joint substrates as follows:
 - a. Locate test joints where indicated on Project or, if not indicated, as directed by Architect.
 - b. Conduct field tests for each kind of sealant and joint substrate.
 - c. Notify Architect seven days in advance of dates and times when test joints will be erected.
 - d. Arrange for tests to take place with joint-sealant manufacturer's technical representative present.
 - e. Test Method: Test joint sealants according to Method A, Tail Procedure, in ASTM C1521.
 - i For joints with dissimilar substrates, verify adhesion to each substrate separately; extend cut along one side, verifying adhesion to opposite side. Repeat procedure for opposite side.

- f. Report whether sealant failed to adhere to joint substrates or tore cohesively. Include data on pull distance used to test each kind of product and joint substrate. For sealants that fail adhesively, retest until satisfactory adhesion is obtained.
- g. Evaluation of Preconstruction Field-Adhesion-Test Results: Sealants not evidencing adhesive failure from testing, in absence of other indications of noncompliance with requirements, will be considered satisfactory. Do not use sealants that fail to adhere to joint substrates during testing.

A.6.9 FIELD CONDITIONS

- a. Do not proceed with installation of joint sealants under the following conditions:
 - i. When ambient and substrate temperature conditions are outside limits permitted by joint-sealant manufacturer or are below 40 deg F (5 deg C).
 - ii. When joint substrates are wet.
 - iii. Where joint widths are less than those allowed by joint-sealant manufacturer for applications indicated.
 - iv. Where contaminants capable of interfering with adhesion have not yet been removed from joint substrates.

A.6.10 WARRANTY

- 1. Special Installer's Warranty: Installer agrees to repair or replace joint sealants that do not comply with performance and other requirements specified in this Section within specified warranty period.
 - a. Warranty Period: One year from date of Substantial Completion.
- 2. Special Manufacturer's Warranty: Manufacturer agrees to furnish joint sealants to repair or replace those joint sealants that do not comply with performance and other requirements specified in this Section within specified warranty period.
 - a. Warranty Period: Five years from date of Substantial Completion.
- 3. Special warranties specified in this article exclude deterioration or failure of joint sealants from the following:
 - a. Movement of the structure caused by stresses on the sealant exceeding sealant manufacturer's written specifications for sealant elongation and compression.
 - b. Disintegration of joint substrates from causes exceeding design specifications.
 - c. Mechanical damage caused by individuals, tools, or other outside agents.
 - d. Changes in sealant appearance caused by accumulation of dirt or other atmospheric contaminants.

B Materials

B.1 Bituminous Dampproofing

B.1.1 SOURCE LIMITATIONS

- 1. Source Limitations: Obtain primary dampproofing materials and primers from single source from single manufacturer. Provide protection course drainage panels and auxiliary materials recommended in writing by manufacturer of primary materials.

B.1.2 PERFORMANCE REQUIREMENTS

- 1. VOC Content: Products are to comply with VOC content limits of authorities having jurisdiction unless otherwise indicated.

B.1.3 COLD-APPLIED, EMULSIFIED-ASPHALT DAMPPROOFING

1. Trowel Coats: ASTM D1227, Type II, Class 1.
2. Fibered Brush and Spray Coats: ASTM D1227, Type II, Class 1.
3. Brush and Spray Coats: ASTM D1227, Type III, Class 1.

B.1.4 AUXILIARY MATERIALS

1. Furnish auxiliary materials recommended in writing by dampproofing manufacturer for intended use and compatible with bituminous dampproofing.
2. Cut-Back-Asphalt Primer: ASTM D41/D41M.
3. Emulsified-Asphalt Primer: ASTM D1227, Type III, Class 1, except diluted with water as recommended in writing by manufacturer.
4. Asphalt-Coated Glass Fabric: ASTM D1668/D1668M, Type I.
5. Patching Compound: Epoxy or latex-modified repair mortar Asbestos-free fibered mastic of type recommended in writing by dampproofing manufacturer.
6. ASTM D6506, semirigid sheets of fiberglass or mineral-reinforced-asphaltic core, pressure laminated between two asphalt-saturated fibrous liners.
 - a. Thickness: Nominal 1/8 inch (3 mm) 1/4 inch (6 mm).
 - b. Adhesive: Rubber-based solvent type recommended in writing by waterproofing manufacturer for protection course type.
7. Fan folded, with a core of extruded-polystyrene board insulation faced on one side or both sides with plastic film, nominal thickness 1/4 inch (6 mm), with a compressive strength of not less than 8 psi (55 kPa) per ASTM D1621, and maximum water absorption by volume of 0.6 percent per ASTM C272/C272M.
8. Extruded-polystyrene board insulation, unfaced, ASTM C578, Type X, 1/2 inch (13 mm) thick.
9. Smooth-surfaced roll roofing complying with ASTM D6380/D6380M, Class S, Type III.

B.1.5 MOLDED-SHEET DRAINAGE PANELS

1. Nonwoven-Geotextile-Faced, Molded-Sheet Drainage Panel: Composite subsurface drainage panel acceptable to dampproofing manufacturer and consisting of a studded, nonbiodegradable, molded-plastic-sheet drainage core; with a nonwoven, needle-punched geotextile facing with an apparent opening size not exceeding No. 70 (0.21-mm) sieve laminated to one side of the core, with or without a polymeric film bonded to the other side; and with a vertical flow rate through the core of 9 to 21 gpm per ft. (112 to 261 L/min. per m).

B.1.6 INSULATION DRAINAGE PANELS

1. Insulation Drainage Panels:
 - a. Comply with Section "Thermal Insulation" for insulation drainage panels.
 - b. Unfaced or geotextile-faced, extruded-polystyrene board insulation according to ASTM C578, Type IV, 25-psi (173-kPa), or Type VI, 40-psi (276-kPa), minimum compressive strength; fabricated with shiplap or channel edges and with one side having grooved drainage channels.

B.2 Non-bituminous Self-Adhering Sheet Air Barriers

B.2.1 MATERIALS

1. Source Limitations: Obtain primary air-barrier materials and air-barrier accessories from single source from single manufacturer.

B.2.2 PERFORMANCE REQUIREMENTS

1. Air-Barrier Performance: Air-barrier assembly and seals with adjacent construction shall be capable of performing as a continuous air barrier and as a liquid-water drainage plane flashed to discharge to the exterior incidental condensation or water penetration. Air-barrier assemblies shall be capable of accommodating substrate movement and of sealing substrate expansion and control joints, construction material changes, penetrations, tie-ins to installed waterproofing, and transitions at perimeter conditions without deterioration and air leakage exceeding specified limits.
2. Air-Barrier Assembly Air Leakage: Maximum 0.04 cfm/sq. ft. of surface area at 1.57 lbf/sq. ft. (0.2 L/s x sq. m of surface area at 75 Pa), when tested according to ASTM E2357.

B.2.3 NONBITUMINOUS SHEET AIR BARRIER

1. Vapor-Retarding Nonbituminous Sheet: Minimum 10-mil- (0.25-mm-) thick, self-adhering sheet consisting of 5 mils (0.13 mm) of air-barrier film and a 5-mil- (0.13-mm-) thick, acrylic adhesive with release liner on adhesive side and formulated for application with primer that complies with VOC limits.
 - a. Physical and Performance Properties:
 - i Air Permeance: Maximum 0.004 cfm/sq. ft. of surface area at 1.57-lbf/sq. ft. (0.02 L/s x sq. m of surface area at 75-Pa) pressure difference; ASTM E2178.
 - ii Puncture Resistance: Minimum 40 lbf (180 N) ; ASTM E154/E154M.
 - iii Vapor Permeance: Maximum 1.0 perm (57.5 ng/Pa x s x sq. m) ; ASTM E96/E96M, Desiccant Method.
 - iv Adhesion to Substrate: Minimum 16 lbf/sq. in. (110 kPa) when tested according to ASTM D4541 as modified by ABAA.
 - v Fire Propagation Characteristics: Passes NFPA 285 testing as part of an approved assembly.
 - vi UV Resistance: Can be exposed to sunlight for 150 days according to manufacturer's written instructions.
2. Vapor-Permeable Nonbituminous Sheet: Minimum 20-mil- (0.5-mm-) thick, self-adhering sheet consisting of a breathable carrier film or fabric and an adhesive with release liner on adhesive side and formulated for application with primer that complies with VOC limits.
 - a. Manufacturers: Cosella-Dorcken Products, Inc or approved equal
 - b. Physical and Performance Properties:
 - i Air Permeance: Maximum 0.004 cfm/sq. ft. of surface area at 1.57-lbf/sq. ft. (0.02 L/s x sq. m of surface area at 75-Pa) pressure difference; ASTM E2178.
 - ii Puncture Resistance: Minimum 40 lbf (180 N); ASTM E154/E154M.
 - iii Vapor Permeance: Minimum 15 perms (860 ng/Pa x s x sq. m) ; ASTM E96/E96M, Desiccant Method, Procedure A.
 - iv Adhesion to Substrate: Minimum 16 lbf/sq. in. (110 kPa) when tested according to ASTM D4541 as modified by ABAA.
 - v Fire Propagation Characteristics: Passes NFPA 285 testing as part of an approved assembly.
 - vi UV Resistance: Can be exposed to sunlight for 150 days according to manufacturer's written instructions.

B.2.4 ACCESSORY MATERIALS

1. Requirement: Provide primers, transition strips, termination strips, joint sealants, counterflashing strips, flashing sheets and metal termination bars, termination mastic, substrate patching materials, adhesives, tapes, foam sealants, lap sealants, and other accessory materials that are recommended in writing by air-barrier manufacturer to produce a complete air-barrier assembly

and that are compatible with primary air-barrier material and adjacent construction to which they may seal.

2. Primer: Liquid waterborne solvent-borne primer recommended for substrate by air-barrier material manufacturer.
3. Stainless-Steel Sheet: ASTM A240/A240M, Type 304, 0.0187 inch (0.5 mm) 0.0250 inch (0.64 mm) thick, and Series 300 stainless-steel fasteners.
4. Preformed Silicone Extrusion: Manufacturer's standard system consisting of cured low-modulus silicone extrusion, sized to fit opening widths, with a single-component, neutral-curing, Class 100/50 (low-modulus) silicone sealant for bonding extrusions to substrates.

B.3 Penetration Firestopping

B.3.1 SOURCE LIMITATIONS

1. Obtain joint firestop systems for each type of joint opening indicated from single manufacturer
2. Manufacturer: Hilti or approved equal.

B.3.2 PERFORMANCE REQUIREMENTS

1. Fire-Test-Response Characteristics:
 - a. Perform penetration firestopping system tests by a qualified testing agency acceptable to authorities having jurisdiction.
 - b. Test per testing standards referenced in "Penetration Firestopping Systems" Article. Provide rated systems complying with the following requirements:
 - i Penetration firestop systems installed with products bearing the classification marking of a qualified product certification agency according to listed system designs published by a qualified testing agency.
 - 1) UL in its online directory "Product iQ."
 - 2) Intertek Group in its "Directory of Building Products."
 - 3) FM Approvals in its "Approval Guide."

B.3.3 PENETRATION FIRESTOPPING SYSTEMS

1. Penetration Firestopping Systems: Systems that resist spread of fire, passage of smoke and other gases, and maintain original fire-resistance rating of construction penetrated. Penetration firestopping systems are to be compatible with one another, with the substrates forming openings, and with penetrating items if any.
2. Penetrations in Fire-Resistance-Rated Walls: Penetration firestopping systems with ratings determined per ASTM E814 or UL 1479.
 - a. F-Rating: Not less than the fire-resistance rating of the wall penetrated.
 - b. Membrane Penetrations: Install recessed fixtures such that the required fire resistance will not be reduced.
3. Penetrations in Horizontal Assemblies: Penetration firestopping systems with ratings determined per ASTM E814 or UL 1479.
 - a. F-Rating: At least one hour, but not less than the fire-resistance rating of the floor penetrated.
 - b. T-Rating: At least one hour, but not less than the fire-resistance rating of the floor. The following floor penetrations do not require a T-rating:
 - i Those within the cavity of a wall.
 - ii Floor, tub, or shower drains within a concealed space.
 - iii 4-inch (200-mm) or smaller metal conduit penetrating directly into metal-enclosed electrical switchgear.

- c. W-Rating: Provide penetration firestopping systems with a Class 1 W-rating according to UL 1479.
- 4. Penetrations in Smoke Barriers: Penetration firestopping systems with ratings determined per UL 1479.
 - a. L-Rating: Not exceeding 5.0 cfm/sq. ft. (0.025 cu. m/s per sq. m) of penetration opening and no more than 50-cfm (0.024-cu. m/s) cumulative total for any 100 sq. ft. (9.3 sq. m) at both ambient and elevated temperatures.
- 5. Exposed Penetration Firestopping Systems: Flame-spread and smoke-developed indexes of less than 25 and 450, respectively, per ASTM E84.
- 6. Accessories: Provide components for each penetration firestopping system that are needed to install fill materials and to maintain ratings required. Use only those components specified by penetration firestopping system manufacturer and approved by qualified testing and inspecting agency for conditions indicated.
 - a. Permanent forming/damming/backing materials.
 - b. Substrate primers.
 - c. Collars.
 - d. Steel sleeves.

B.3.4 FILL MATERIALS

1. Cast-in-Place Firestop Devices: Factory-assembled devices for use in cast-in-place concrete floors and consisting of an outer sleeve lined with an intumescent strip, a flange attached to one end of the sleeve for fastening to concrete formwork, and a neoprene gasket.
2. Latex Sealants: Single-component latex formulations that do not re-emulsify after cure during exposure to moisture.
3. Firestop Devices: Factory-assembled collars formed from galvanized steel and lined with intumescent material sized to fit specific diameter of penetrant.
4. Intumescent Composite Sheets: Rigid panels consisting of aluminum-foil-faced intumescent elastomeric sheet bonded to galvanized-steel sheet.
5. Intumescent Putties: Nonhardening, water-resistant, intumescent putties containing no solvents or inorganic fibers.
6. Intumescent Wrap Strips: Single-component intumescent elastomeric strips for use around combustible penetrants.
7. Mortars: Prepackaged dry mixes consisting of a blend of inorganic binders, hydraulic cement, fillers and lightweight aggregate formulated for mixing with water at Project site to form a non-shrinking, homogeneous mortar.
8. Pillows/Bags: Compressible, removable, and reusable intumescent pillows encased in fire-retardant polyester or glass-fiber cloth. Where exposed, cover openings with steel-reinforcing wire mesh to protect pillows/bags from being easily removed.
9. Silicone Foams: Multicomponent, silicone-based liquid elastomers that, when mixed, expand and cure in place to produce a flexible, non-shrinking foam.
10. Silicone Sealants: Single-component, silicone-based, neutral-curing elastomeric sealants.
11. Fire-Rated Cable Sleeve Kits: Complete kits designed for new or existing cable penetrations through walls to accept standard accessories.
12. Thermal Wrap: Flexible protective wrap tested and listed for up to 2-hour fire ratings according to ASTM E814/UL 1479 for membrane penetrations or ASTM E1725/UL 1724 for thermal barrier and circuit integrity protection.
13. Fire-Rated Cable Pathways: Single or gangable device modules composed of a steel raceway with integral intumescent material and requiring no additional action in the form of plugs, twisting closure, putty, pillows, sealant, or otherwise to achieve fire and air-leakage ratings.

14. Retrofit Device for Cable Bundles: Factory-made, intumescent, collar-like device for firestopping existing over-filled cable sleeves and capable of being installed around projecting sleeves and cable bundles.
15. Wall-Opening Protective Materials: Intumescent, non-curing putty pads or self-adhesive inserts for protection of electrical switch and receptacle boxes.
16. Fire-Rated HVAC Retaining Angles: Steel angle system with integral intumescent firestop gasket for use around rectangular steel HVAC ducts without fire dampers.
17. Firestop Plugs: Flexible, re-enterable, intumescent, foam-rubber plug for use in blank round openings and cable sleeves.
18. Fire-Rated Cable Grommet: Molded two-piece grommet made of plenum-grade polymer and foam inner core for sealing small cable penetrations in gypsum walls up to 1/2 inch (13 mm) diameter.
19. Closet Flange Gasket: Molded, single-component, flexible, intumescent gasket for use beneath a water closet (toilet) flange in floor applications.
20. Endothermic Wrap: Flexible, insulating, fire-resistant, endothermic wrap for protecting membrane penetrations of utility boxes, critical electrical circuits, communications lines, and fuel lines.

B.3.5 MIXING

1. Penetration Firestopping Materials: For those products requiring mixing before application, comply with penetration firestopping system manufacturer's written instructions for accurate proportioning of materials, water (if required), type of mixing equipment, selection of mixer speeds, mixing containers, mixing time, and other items or procedures needed to produce products of uniform quality with optimum performance characteristics for application indicated.

B.4 Joint Firestopping

B.4.1 SOURCE LIMITATIONS

1. Obtain joint firestop systems for each type of joint opening indicated from single manufacturer.

B.4.2 PERFORMANCE REQUIREMENTS

1. Fire-Test-Response Characteristics:
 - a. Perform joint firestopping system tests by a qualified testing agency acceptable to authorities having jurisdiction.
 - b. Test per testing standards referenced in "Joint Firestopping Systems" Article. Provide rated systems complying with the following requirements:
 - i. Joint firestop systems installed with products bearing the classification marking of a qualified product certification agency according to Listed System Designs published by a qualified testing agency.
 - 1) UL in its online directory "Product iQ."
 - 2) Intertek Group in its "Directory of Building Products."
2. Rain/Water Resistance: For perimeter fire-barrier system applications, where inclement weather or greater-than-transient water exposure is expected, use products that dry rapidly and cure in the presence of atmospheric moisture sufficient to pass ASTM D6904 early rain-resistance test (24-hour exposure).

B.4.3 JOINT FIRESTOPPING SYSTEMS

1. Joint Firestopping Systems: Systems that resist spread of fire, passage of smoke and other gases, and maintain original fire-resistance rating of assemblies in or between which joint firestopping systems are installed. Joint firestopping systems must accommodate building movements without impairing their ability to resist the passage of fire and hot gases.

- a. Joint firestopping systems that are compatible with one another, with the substrates forming openings, and with penetrating items, if any.
 - b. Provide products that, upon curing, do not re-emulsify, dissolve, leach, breakdown, or otherwise deteriorate over time from exposure to atmospheric moisture, sweating pipes, ponding water or other forms of moisture.
 - c. Provide firestop products that do not contain ethylene glycol.
2. Intumescent Gypsum Wall Framing Gaskets (Applied to Steel Tracks, Runners and Studs prior to Framing Installation): Provide products with fire, smoke, and acoustical ratings that allow movement up to 100 percent compression and/or extension according to UL 2079 or ASTM E1966; have an L Rating less than 1 cfm/ft. (0.00115 cu. m/s x m) according to UL 2079; and a minimum Sound Transmission Class (STC) rating of 56 according to ASTM E90 or ASTM C919.
 3. For aluminum curtain-wall assemblies with one- or two-piece rectangular mullions at least 2-1/2 by 5 inches (64 by 127 mm), provide perimeter fire-barrier system that does not require direct screw attachment to mullions and transoms to support and fasten curtain-wall insulation. System to be tested according to ASTM E2307 for up to 2-hour fire resistance and with ASTM E1233 for wind cycling equivalent to 108 mph (174 km/h) wind for 500 cycles.
 4. Joints in or between Fire-Resistance-Rated Construction: Provide joint firestopping systems with ratings determined per ASTM E1966 or UL 2079.
 - a. Fire-Resistance Rating: Equal to or exceeding the fire-resistance rating of the wall, floor, or roof in or between which it is installed.
 5. Joints at Exterior Curtain-Wall/Floor Intersections: Provide joint firestopping systems with rating determined per ASTM E2307.
 - a. F-Rating: Equal to or exceeding the fire-resistance rating of the floor assembly.
 6. Exposed Joint Firestopping Systems: Flame-spread and smoke-developed indexes of less than 25 and 450, respectively, as determined per ASTM E84.

B.4.4 ACCESSORIES

1. Provide components of joint firestopping systems, including primers and forming materials, that are needed to install elastomeric fill materials and to maintain ratings required. Use only components specified by joint firestopping system manufacturer and approved by the qualified testing agency for conditions indicated.

B.5 Joint Sealants

B.5.1 SOURCE LIMITATIONS

1. Obtain joint sealants from single manufacturer for each sealant type.

B.5.2 JOINT SEALANTS, GENERAL

1. Compatibility: Provide joint sealants, backings, and other related materials that are compatible with one another and with joint substrates under conditions of service and application, as demonstrated by joint-sealant manufacturer, based on testing and field experience.
2. Colors of Exposed Joint Sealants: As indicated by manufacturer's designations Match Architect's samples As selected by Architect from manufacturer's full range.

B.5.3 SILICONE JOINT SEALANTS

1. Silicone, S, NS, 100/50, NT: Single-component, nonsag, plus 100 percent and minus 50 percent movement capability, nontraffic-use, neutral-curing silicone joint sealant; ASTM C920, Type S, Grade NS, Class 100/50, Use NT.
 - a. Manufacturer: Tremco or approved equal.

2. Silicone, S, NS, 50, NT: Single-component, nonsag, plus 50 percent and minus 50 percent movement capability, nontraffic-use, neutral-curing silicone joint sealant; ASTM C920, Type S, Grade NS, Class 50, Use NT.
 - a. Manufacturer: Tremco or approved equal.
3. Silicone, S, NS, 35, NT: Single-component, nonsag, plus 35 percent and minus 35 percent movement capability. nontraffic-use, neutral-curing silicone joint sealant; ASTM C920, Type S, Grade NS, Class 35, Use NT.
 - a. Manufacturer: Tremco or approved equal.
4. Silicone, S, NS, 25, NT: Single-component, nonsag, plus 25 percent and minus 25 percent movement capability, nontraffic-use, neutral-curing silicone joint sealant; ASTM C920, Type S, Grade NS, Class 25, Use NT.
 - a. Manufacturer: Tremco or approved equal.
5. Silicone, Acid Curing, S, NS, 25, NT: Single-component, nonsag, plus 25 percent and minus 25 percent movement capability, nontraffic-use, acid-curing silicone joint sealant; ASTM C920, Type S, Grade NS, Class 25, Use NT.
 - a. Manufacturer: Tremco or approved equal.
6. Silicone, S, NS, 100/50, T, NT: Single-component, nonsag, plus 100 percent and minus 50 percent movement capability, traffic- and nontraffic-use, neutral-curing silicone joint sealant; ASTM C920, Type S, Grade NS, Class 100/50, Uses T and NT.
 - a. Manufacturer: Tremco or approved equal.
7. Silicone, S, NS, 50, T, NT: Single-component, nonsag, plus 50 percent and minus 50 percent movement capability, traffic- and nontraffic-use, neutral-curing silicone joint sealant; ASTM C920, Type S, Grade NS, Class 50, Uses T and NT.
 - a. Manufacturer: Tremco or approved equal.
8. Silicone, S, NS, 25, T, NT: Single-component, nonsag, plus 25 percent and minus 25 percent movement capability, traffic- and nontraffic-use, neutral-curing silicone joint sealant; ASTM C920, Type S, Grade NS, Class 25, Uses T and NT.
 - a. Manufacturer: Tremco or approved equal.
9. Silicone, S, P, 100/50, T, NT: Single-component, pourable, plus 100 percent and minus 50 percent movement capability traffic- and nontraffic-use, neutral-curing silicone joint sealant; ASTM C920, Type S, Grade P, Class 100/50, Uses T and NT.
 - a. Manufacturer: Tremco or approved equal.
10. Silicone, M, P, 100/50, T, NT: Multicomponent, pourable, plus 100 percent and minus 50 percent movement capability, traffic- and nontraffic-use, neutral-curing silicone joint sealant; ASTM C920, Type M, Grade P, Class 100/50, Uses T and NT.
 - a. Manufacturer: Tremco or approved equal.

B.5.4 NONSTAINING SILICONE JOINT SEALANTS

1. Nonstaining Joint Sealants: No staining of substrates when tested according to ASTM C1248.
2. Silicone, Nonstaining, S, NS, 100/50, NT: Nonstaining, single-component, nonsag, plus 100 percent and minus 50 percent movement capability, nontraffic-use, neutral-curing silicone joint sealant; ASTM C920, Type S, Grade NS, Class 100/50, Use NT.
3. Silicone, Nonstaining, S, NS, 50, NT: Nonstaining, single-component, nonsag, plus 50 percent and minus 50 percent movement capability, nontraffic-use, neutral-curing silicone joint sealant; ASTM C920, Type S, Grade NS, Class 50, Use NT.
4. Silicone, Nonstaining, S, NS, 100/50, T, NT: Nonstaining, single-component, nonsag, plus 100 percent and minus 50 percent movement capability, traffic- and nontraffic-use, neutral-curing silicone joint sealant; ASTM C920, Type S, Grade NS, Class 100/50, Uses T and NT.

5. Silicone, Nonstaining, M, NS, 50, NT: Nonstaining, multicomponent, nonsag, plus 50 percent and minus 50 percent movement capability, nontraffic-use, neutral-curing silicone joint sealant; ASTM C920, Type M, Grade NS, Class 50, Use NT.

B.5.5 URETHANE JOINT SEALANTS

1. Urethane, S, NS, 25, NT: Single-component, nonsag, plus 25 percent and minus 25 percent movement capability, nontraffic-use, urethane joint sealant; ASTM C920, Type S, Grade NS, Class 25, Use NT.
2. Urethane, S, NS, 100/50, T, NT: Single-component, nonsag, plus 100 percent and minus 50 percent movement capability, traffic- and nontraffic-use, urethane joint sealant; ASTM C920, Type S, Grade NS, Class 100/50, Uses T and NT.
3. Urethane, S, NS, 25, T, NT: Single-component, nonsag, plus 25 percent and minus 25 percent movement capability, traffic- and nontraffic-use, urethane joint sealant; ASTM C920, Type S, Grade NS, Class 25, Uses T and NT.
4. Urethane, S, P, 35, T, NT: Single-component, pourable, plus 35 percent and minus 35 percent movement capability, traffic- and nontraffic-use, urethane joint sealant; ASTM C920, Type S, Grade P, Class 35, Uses T and NT.
5. Urethane, S, P, 25, T, NT: Single-component, pourable, plus 25 percent and minus 25 percent movement capability, traffic- and nontraffic-use, urethane joint sealant; ASTM C920, Type S, Grade P, Class 25, Uses T and NT.
6. Urethane, M, NS, 50, NT: Multicomponent, nonsag, plus 50 percent and minus 50 percent movement capability nontraffic-use, urethane joint sealant; ASTM C920, Type M, Grade NS, Class 50, Use NT.
7. Urethane, M, NS, 25, NT: Multicomponent, nonsag, plus 25 percent and minus 25 percent movement capability, nontraffic-use, urethane joint sealant; ASTM C920, Type M, Grade NS, Class 25, Use NT.
8. Urethane, M, NS, 50, T, NT: Multicomponent, nonsag, plus 50 percent and minus 50 percent movement capability, traffic- and nontraffic-use, urethane joint sealant; ASTM C920, Type M, Grade NS, Class 50, Uses T and NT.
9. Urethane, M, NS, 25, T, NT: Multicomponent, nonsag, plus 25 percent and minus 25 percent movement capability, traffic- and nontraffic-use, urethane joint sealant; ASTM C920, Type M, Grade NS, Class 25, Uses T and NT.
10. Urethane, M, P, 50, T, NT: Multicomponent, pourable, plus 50 percent and minus 50 percent movement capability, traffic- and nontraffic-use, urethane joint sealant; ASTM C920, Type M, Grade P, Class 50, Uses T and NT.
11. Urethane, M, P, 25, T, NT: Multicomponent, pourable, plus 25 percent and minus 25 percent movement capability, traffic- and nontraffic-use, urethane joint sealant; ASTM C920, Type M, Grade P, Class 25, Uses T and NT.

B.5.6 LATEX JOINT SEALANTS

1. Acrylic latex, ASTM C834, Type OP, Grade NF.

B.5.7 JOINT-SEALANT BACKING

1. Sealant Backing Material, General: Nonstaining; compatible with joint substrates, sealants, primers, and other joint fillers; and approved for applications indicated by sealant manufacturer based on field experience and laboratory testing.
2. Cylindrical Sealant Backings: ASTM C1330, Type C (closed-cell material with a surface skin) Type O (open-cell material) Type B (bicellular material with a surface skin) or any of the preceding types, as approved in writing by joint-sealant manufacturer for joint application indicated, and of size and density to control sealant depth and otherwise contribute to producing optimum sealant performance.

3. Bond-Breaker Tape: Polyethylene tape or other plastic tape recommended by sealant manufacturer for preventing sealant from adhering to rigid, inflexible joint-filler materials or joint surfaces at back of joint. Provide self-adhesive tape where applicable.

B.5.8 MISCELLANEOUS MATERIALS

1. Primer: Material recommended by joint-sealant manufacturer where required for adhesion of sealant to joint substrates indicated, as determined from preconstruction joint-sealant-substrate tests and field tests.
2. Cleaners for Nonporous Surfaces: Chemical cleaners acceptable to manufacturers of sealants and sealant backing materials, free of oily residues or other substances capable of staining or harming joint substrates and adjacent nonporous surfaces in any way, and formulated to promote optimum adhesion of sealants to joint substrates.
3. Masking Tape: Nonstaining, nonabsorbent material compatible with joint sealants and surfaces adjacent to joints.

C Construction

C.1 Bituminous Dampproofing

C.1.1 EXAMINATION

1. Examine substrates, areas, and conditions, with Applicator present, for compliance with requirements for surface smoothness, maximum surface moisture content, and other conditions affecting performance of the Work.
2. Proceed with application only after substrate construction and penetrating work have been completed and unsatisfactory conditions have been corrected.

C.1.2 PREPARATION

1. Clean, prepare, and treat substrates according to manufacturer's written instructions. Provide clean, dust-free, and dry substrates for dampproofing application.
2. Mask or otherwise protect adjoining exposed surfaces from being stained, spotted, or coated with dampproofing. Prevent dampproofing materials from entering and clogging weep holes and drains.
3. Clean substrates of projections and substances detrimental to dampproofing work; fill voids, seal joints, and remove bond breakers if any.
4. Apply patching compound to patch and fill tie holes, honeycombs, reveals, and other imperfections; cover with asphalt-coated glass fabric.

C.1.3 INSTALLATION, GENERAL

1. Comply with manufacturer's written instructions for dampproofing application, cure time between coats, and drying time before backfilling unless otherwise indicated.
 - a. Apply dampproofing to provide continuous plane of protection.
 - b. Apply additional coats if recommended in writing by manufacturer or to achieve a smooth surface and uninterrupted coverage.
2. Where dampproofing footings and foundation walls, apply from finished-grade line to top of footing; extend over top of footing and down a minimum of 6 inches (150 mm) over outside face of footing.
 - a. Extend dampproofing 12 inches (300 mm) onto intersecting walls and footings, but do not extend onto surfaces exposed to view when Project is completed.
 - b. Install flashings and corner protection stripping at internal and external corners, changes in plane, construction joints, cracks, and where indicated as "reinforced," by embedding an 8-inch- (200-mm-) wide strip of asphalt-coated glass fabric in a heavy coat of dampproofing. Dampproofing coat for embedding fabric is in addition to other coats required.

3. Where dampproofing exterior face of inner wythe of exterior masonry cavity walls, lap dampproofing at least 1/4 inch (6 mm) onto flashing, masonry reinforcement, veneer ties, and other items that penetrate inner wythe.
 - a. Extend dampproofing over outer face of structural members and concrete slabs that interrupt inner wythe.
 - b. Lap dampproofing at least 1/4 inch (6 mm) onto shelf angles supporting veneer.
4. Where dampproofing interior face of above-grade, exterior concrete and masonry single-wythe masonry walls, continue dampproofing through intersecting walls by keeping vertical mortar joints at intersection temporarily open or by dampproofing wall before constructing intersecting walls.

C.1.4 INSTALLATION OF COLD-APPLIED, CUT-BACK-ASPHALT DAMPPROOFING

1. Concrete Foundations and Parged Masonry Foundation Walls: Apply two brush or spray coats at not less than 1.25 gal./100 sq. ft. (0.5 L/sq. m) for first coat and 1 gal./100 sq. ft. (0.4 L/sq. m) for second coat or one trowel coat at not less than 4 gal./100 sq. ft. (1.6 L/sq. m).
2. Unparged Masonry Foundation Walls: Apply primer and two brush or spray coats at not less than 1.25 gal./100 sq. ft. (0.5 L/sq. m) for first coat and 1 gal./100 sq. ft. (0.4 L/sq. m) for second coat or primer and one trowel coat at not less than 4 gal./100 sq. ft. (1.6 L/sq. m).
3. Unexposed Face of Concrete Retaining Walls: Apply one brush or spray coat at not less than 1.25 gal./100 sq. ft. (0.5 L/sq. m).
4. Unexposed Face of Masonry Retaining Walls: Apply primer and one brush or spray coat at not less than 1.25 gal./100 sq. ft. (0.5 L/sq. m).
5. Concrete Backup for Masonry Veneer Assemblies: Apply one brush or spray coat at not less than 1 gal./100 sq. ft. (0.4 L/sq. m).
6. Masonry Backup for Masonry Veneer Assemblies: Apply primer and one brush or spray coat at not less than 1 gal./100 sq. ft. (0.4 L/sq. m).
7. Exterior Face of Inner Wythe of Cavity Walls: Apply primer and one brush or spray coat at not less than 1 gal./100 sq. ft. (0.4 L/sq. m).

C.1.5 INSTALLATION OF COLD-APPLIED, EMULSIFIED-ASPHALT DAMPPROOFING

1. Concrete Foundations and Parged Masonry Foundation Walls: Apply two brush or spray coats at not less than 1.5 gal./100 sq. ft. (0.6 L/sq. m) for first coat and 1 gal./100 sq. ft. (0.4 L/sq. m) for second coat one fibered brush or spray coat at not less than 3 gal./100 sq. ft. (1.2 L/sq. m) or one trowel coat at not less than 4 gal./100 sq. ft. (1.6 L/sq. m).
2. Unparged Masonry Foundation Walls: Apply primer and two brush or spray coats at not less than 1.5 gal./100 sq. ft. (0.6 L/sq. m) for first coat and 1 gal./100 sq. ft. (0.4 L/sq. m) for second coat primer and one fibered brush or spray coat at not less than 3 gal./100 sq. ft. (1.2 L/sq. m) or primer and one trowel coat at not less than 5 gal./100 sq. ft. (2 L/sq. m).
3. Unexposed Face of Concrete Retaining Walls: Apply one brush or spray coat at not less than 1.25 gal./100 sq. ft. (0.5 L/sq. m).
4. Unexposed Face of Masonry Retaining Walls: Apply primer and one brush or spray coat at not less than 1.25 gal./100 sq. ft. (0.5 L/sq. m).
5. Concrete Backup for Masonry Veneer Assemblies: Apply one brush or spray coat at not less than 1 gal./100 sq. ft. (0.4 L/sq. m).
6. Masonry Backup for Masonry Veneer Assemblies: Apply primer and one brush or spray coat at not less than 1 gal./100 sq. ft. (0.4 L/sq. m).
7. Exterior Face of Inner Wythe of Cavity Walls: Apply primer and one brush or spray coat at not less than 1 gal./100 sq. ft. (0.4 L/sq. m).
8. Interior Face of Exterior Concrete Walls: Where above grade and indicated to be furred and finished, apply one brush or spray coat at not less than 1 gal./100 sq. ft. (0.4 L/sq. m).

9. Interior Face of Exterior Masonry Walls: Where above grade and indicated to be furred and finished, apply primer and one brush or spray coat at not less than 1 gal./100 sq. ft. (0.4 L/sq. m).

C.1.6 INSTALLATION OF PROTECTION COURSE

1. Install protection course over completed-and-cured dampproofing. Comply with dampproofing-material and protection-course manufacturers' written instructions for attaching protection course.
2. Support protection course over cured coating with spot application of adhesive type recommended in writing by protection-board manufacturer.
3. Install protection course on same day within 24 hours of dampproofing installation (while coating is tacky) to ensure adhesion.

C.1.7 INSTALLATION OF DRAINAGE PANEL

1. Molded-Sheet Drainage Panels: Install panels, with geotextile facing away from wall substrate, according to manufacturer's written instructions. Use adhesive or another method that does not penetrate dampproofing. Lap edges and ends of geotextile to maintain continuity. Protect installed molded-sheet drainage panels during subsequent construction.
 - a. Install thermal insulation specified in Section "Thermal Insulation," protection course before installing drainage panels.
 - b. Insulation Drainage Panels: Install panels over dampproofed surfaces. Use adhesive or another method that does not penetrate dampproofing. Cut and fit panels to within 3/4 inch (19 mm) of projections and penetrations.
 - c. Ensure that drainage channels are aligned and free of obstructions.

C.1.8 PROTECTION

1. Protect installed insulation drainage panels from damage due to UV light, harmful weather exposures, physical abuse, and other causes. Provide temporary coverings where panels are subject to abuse and cannot be concealed and protected by permanent construction immediately after installation.
2. Correct dampproofing that does not comply with requirements; repair substrates and reapply dampproofing.

C.2 Non-bituminous Self-Adhering Sheet Air Barriers

C.2.1 EXAMINATION

1. Examine substrates, areas, and conditions, with Installer present, for compliance with requirements and other conditions affecting performance of the Work.
 - a. Verify that substrates are sound and free of oil, grease, dirt, excess mortar, or other contaminants.
 - b. Verify that substrates have cured and aged for minimum time recommended in writing by air-barrier manufacturer.
 - c. Verify that substrates are visibly dry and free of moisture. Test concrete substrates for capillary moisture by plastic sheet method according to ASTM D4263.
 - d. Verify that masonry joints are flush and completely filled with mortar.
2. Proceed with installation only after unsatisfactory conditions have been corrected.

C.2.2 SURFACE PREPARATION

1. Clean, prepare, treat, fill, and seal substrate and joints and cracks in substrate according to manufacturer's written instructions and details. Provide clean, dust-free, and dry substrate for air-barrier application.
2. Mask off adjoining surfaces not covered by air barrier to prevent spillage and overspray affecting other construction.

3. Remove grease, oil, bitumen, form-release agents, paints, curing compounds, and other penetrating contaminants or film-forming coatings from concrete.
4. Remove fins, ridges, mortar, and other projections and fill honeycomb, aggregate pockets, holes, and other voids in concrete with substrate-patching membrane.
5. Remove excess mortar from masonry ties, shelf angles, and other obstructions.
6. At changes in substrate plane, apply sealant or termination mastic beads at sharp corners and edges to form a smooth transition from one plane to another.
7. Cover gaps in substrate plane and form a smooth transition from one substrate plane to another with stainless-steel sheet mechanically fastened to structural framing to provide continuous support for air barrier.
8. Bridge isolation joints expansion joints and discontinuous wall-to-wall, deck-to-wall, and deck-to-deck joints with air-barrier accessory material that accommodates joint movement according to manufacturer's written instructions and details.

C.2.3 INSTALLATION

1. Install materials according to air-barrier manufacturer's written instructions and details to form a seal with adjacent construction and ensure continuity of air and water barrier.
 - a. Unless manufacturer recommends in writing against priming, apply primer to substrates at required rate and allow it to dry.
2. Prepare, treat, and seal inside and outside corners and vertical and horizontal surfaces at terminations and penetrations with termination mastic.
3. Apply primer to substrates at required rate and allow it to dry. Limit priming to areas that will be covered by air-barrier sheet on same day. Reprime areas exposed for more than 24 hours.
4. Apply and firmly adhere air-barrier sheets over area to receive air barrier. Accurately align sheets and maintain uniform 2-1/2-inch- (64-mm-) minimum lap widths and end laps. Overlap and seal seams, and stagger end laps to ensure airtight installation.
 - a. Apply sheets in a shingled manner to shed water.
 - b. Roll sheets firmly to enhance adhesion to substrate.
5. Apply continuous air-barrier sheets over accessory strips bridging substrate cracks, construction, and contraction joints.
6. CMU: Install air-barrier sheet horizontally against the CMU beginning at base of wall. Align top edge of air-barrier sheet immediately below protruding masonry ties or joint reinforcement or ties, and firmly adhere in place.
 - a. Overlap horizontally adjacent sheets a minimum of 2 inches (50 mm) and roll seams.
 - b. Apply overlapping sheets with bottom edge slit to fit around masonry reinforcing or ties. Roll firmly into place.
 - c. Seal around masonry reinforcing or ties and penetrations with termination mastic.
 - d. Continue the sheet into all openings in the wall, such as doors and windows, and terminate at points to maintain an airtight barrier that is not visible from interior.
7. Seal top of through-wall flashings to air-barrier sheet with an additional 6-inch- (150-mm-) wide, transition strip.
8. Seal exposed edges of sheet at seams, cuts, penetrations, and terminations not concealed by metal counterflashings or ending in reglets with termination mastic.

9. Install air-barrier sheet and accessory materials to form a seal with adjacent construction and to maintain a continuous air barrier.
 - a. Coordinate air-barrier installation with installation of roofing membrane and base flashing to ensure continuity of air barrier with roofing membrane.
 - b. Install transition strip on roofing membrane or base flashing so that a minimum of 3 inches (75 mm) of coverage is achieved over each substrate.
10. Connect and seal exterior wall air-barrier sheet continuously to roofing-membrane air barrier, concrete below-grade structures, floor-to-floor construction, exterior glazing and window systems, glazed curtain-wall systems, storefront systems, exterior louvers, exterior door framing, and other construction used in exterior wall openings, using accessory materials.
11. At end of each working day, seal top edge of air-barrier material to substrate with termination mastic.
12. Apply joint sealants forming part of air-barrier assembly within manufacturer's recommended application temperature ranges. Consult manufacturer when sealant cannot be applied within these temperature ranges.
13. Wall Openings: Prime concealed, perimeter frame surfaces of windows, curtain walls, storefronts, and doors. Apply transition strip preformed silicone extrusion so that a minimum of 3 inches (75 mm) of coverage is achieved over each substrate. Maintain 3 inches (75 mm) of contact over firm bearing to perimeter frames, with not less than 1 inch (25 mm) of full contact.
 - a. Transition Strip: Roll firmly to enhance adhesion.
 - b. Preformed Silicone Extrusion: Set in full bed of silicone sealant applied to walls, frame, and air-barrier material.
14. Fill gaps in perimeter frame surfaces of windows, curtain walls, storefronts, doors, and miscellaneous penetrations of air-barrier material with foam sealant.
15. Repair punctures, voids, and deficient lapped seams in air barrier. Slit and flatten fishmouths and blisters. Patch with air-barrier sheet extending 6 inches (150 mm) beyond repaired areas in all directions.
16. Do not cover air barrier until it has been tested and inspected by testing agency.
17. Correct deficiencies in or remove air barrier that does not comply with requirements; repair substrates and reapply air-barrier components.

C.2.4 FIELD QUALITY CONTROL

1. ABAA Quality Assurance Program: Perform examinations, preparation, installation, testing, and inspections under ABAA's Quality Assurance Program.
2. Testing Agency: Owner will engage Engage a qualified testing agency to perform tests and inspections.
3. Inspections: Air-barrier materials, accessories, and installation are subject to inspection for compliance with requirements. Inspections may include the following:
 - a. Continuity of air-barrier system has been achieved throughout the building envelope with no gaps or holes.
 - b. Continuous structural support of air-barrier system has been provided.
 - c. Masonry and concrete surfaces are smooth, clean, and free of cavities, protrusions, and mortar droppings.
 - d. Site conditions for application temperature and dryness of substrates have been maintained.
 - e. Maximum exposure time of materials to UV deterioration has not been exceeded.
 - f. Surfaces have been primed.
 - g. Laps in sheet materials have complied with the minimum requirements and have been shingled in the correct direction (or mastic applied on exposed edges), with no fishmouths.

- h. Termination mastic has been applied on cut edges.
 - i. Air barrier has been firmly adhered to substrate.
 - j. Compatible materials have been used.
 - k. Transitions at changes in direction and structural support at gaps have been provided.
 - l. Connections between assemblies (air barrier and sealants) have complied with requirements for cleanliness, surface preparation and priming, structural support, integrity, and continuity of seal.
 - m. All penetrations have been sealed.
4. Tests: As determined by testing agency from among the following tests:
 - a. Air-Leakage-Location Testing: Air-barrier assemblies will be tested for evidence of air leakage according to ASTM E1186, chamber pressurization or depressurization with smoke tracers ASTM E1186, chamber depressurization using detection liquids.
 - b. Air-Leakage-Volume Testing: Air-barrier assemblies will be tested for air-leakage rate according to ASTM E783 or ASTM E2357 .
 - c. Adhesion Testing: Air-barrier assemblies will be tested for required adhesion to substrate according to ASTM D4541 for each 600 sq. ft. (56 sq. m) of installed air barrier or part thereof.
 5. Air barriers will be considered defective if they do not pass tests and inspections.
 - a. Apply additional air-barrier material, according to manufacturer's written instructions, where inspection results indicate insufficient thickness.
 - b. Remove and replace deficient air-barrier components for retesting as specified above.
 6. Repair damage to air barriers caused by testing; follow manufacturer's written instructions.
 7. Prepare test and inspection reports.

C.2.5 CLEANING AND PROTECTION

1. Protect air-barrier system from damage during application and remainder of construction period, according to manufacturer's written instructions.
 - a. Protect air barrier from exposure to UV light and harmful weather exposure as recommended in writing by manufacturer. If exposed to these conditions for longer than recommended, remove and replace air barrier or install additional, full-thickness, air-barrier application after repairing and preparing the overexposed materials according to air-barrier manufacturer's written instructions.
 - b. Protect air barrier from contact with incompatible materials and sealants not approved by air-barrier manufacturer.
2. Clean spills, stains, and soiling from construction that would be exposed in the completed Work, using cleaning agents and procedures recommended in writing by manufacturer of affected construction.

C.3 Penetration Firestopping

C.3.1 EXAMINATION

1. Examine substrates and conditions, with Installer present, for compliance with requirements for opening configurations, penetrating items, substrates, and other conditions affecting performance of the Work.
2. Proceed with installation only after unsatisfactory conditions have been corrected.

C.3.2 PREPARATION

1. Surface Cleaning: Before installing penetration firestopping systems, clean out openings immediately to comply with manufacturer's written instructions and with the following requirements:

- a. Remove from surfaces of opening substrates and from penetrating items foreign materials that could interfere with adhesion of penetration firestopping materials.
 - b. Clean opening substrates and penetrating items to produce clean, sound surfaces capable of developing optimum bond with penetration firestopping materials. Remove loose particles remaining from cleaning operation.
 - c. Remove laitance and form-release agents from concrete.
2. Prime substrates where recommended in writing by manufacturer using that manufacturer's recommended products and methods. Confine primers to areas of bond; do not allow spillage and migration onto exposed surfaces.

C.3.3 INSTALLATION OF PENETRATION FIRESTOPPING SYSTEMS

1. General: Install penetration firestopping systems to comply with manufacturer's written installation instructions and published drawings for products and applications.
2. Install forming materials and other accessories of types required to support fill materials during their application and in the position needed to produce cross-sectional shapes and depths required to achieve fire ratings.
 - a. After installing fill materials and allowing them to fully cure, remove combustible forming materials and other accessories not forming permanent components of firestopping.
3. Install fill materials by proven techniques to produce the following results:
 - a. Fill voids and cavities formed by openings, forming materials, accessories and penetrating items to achieve required fire-resistance ratings.
 - b. Apply materials so they contact and adhere to substrates formed by openings and penetrating items.
 - c. For fill materials that will remain exposed after completing the Work, finish to produce smooth, uniform surfaces that are flush with adjoining finishes.

C.3.4 IDENTIFICATION

1. Wall Identification: Permanently label walls containing penetration firestopping systems with the words "FIRE AND/OR SMOKE BARRIER - PROTECT ALL OPENINGS," using lettering not less than 3 inches (76 mm) high and with minimum 0.375-inch (9.5-mm) strokes.
 - a. Locate in accessible concealed floor, floor-ceiling, or attic space at 15 feet (4.57 m) from end of wall and at intervals not exceeding 30 feet (9.14 m).
2. Penetration Identification: Identify each penetration firestopping system with legible metal or plastic labels. Attach labels permanently to surfaces adjacent to and within 6 inches (150 mm) of penetration firestopping system edge so labels are visible to anyone seeking to remove penetrating items or firestopping systems. Use mechanical fasteners or self-adhering-type labels with adhesives capable of permanently bonding labels to surfaces on which labels are placed. Include the following information on labels:
 - a. The words "Warning - Penetration Firestopping - Do Not Disturb. Notify Building Management of Any Damage."
 - b. Contractor's name, address, and phone number.
 - c. Designation of applicable testing and inspecting agency.
 - d. Date of installation.
 - e. Manufacturer's name.
 - f. Installer's name.

C.3.5 FIELD QUALITY CONTROL

1. Owner will engage a qualified testing agency to perform tests and inspections according to ASTM E2174.

2. Where deficiencies are found or penetration firestopping system is damaged or removed because of testing, repair or replace penetration firestopping system to comply with requirements.
3. Proceed with enclosing penetration firestopping systems with other construction only after inspection reports are issued and installations comply with requirements.

C.3.6 CLEANING AND PROTECTION

1. Clean off excess fill materials adjacent to openings as the Work progresses by methods and with cleaning materials that are approved in writing by penetration firestopping system manufacturers and that do not damage materials in which openings occur.
2. Provide final protection and maintain conditions during and after installation that ensure that penetration firestopping systems are without damage or deterioration at time of Substantial Completion. If, despite such protection, damage or deterioration occurs, immediately cut out and remove damaged or deteriorated penetration firestopping material and install new materials to produce systems complying with specified requirements.

C.4 Joint Firestopping

C.4.1 EXAMINATION

1. Examine substrates and conditions, with Installer present, for compliance with requirements for joint configurations, substrates, and other conditions affecting performance of the Work.
2. Proceed with installation only after unsatisfactory conditions have been corrected.

C.4.2 PREPARATION

1. Surface Cleaning: Before installing joint firestopping systems, clean joints immediately to comply with fire-resistive joint system manufacturer's written instructions and the following requirements:
 - a. Remove from surfaces of joint substrates foreign materials that could interfere with adhesion of elastomeric fill materials or compromise fire-resistive rating.
 - b. Clean joint substrates to produce clean, sound surfaces capable of developing optimum bond with elastomeric fill materials. Remove loose particles remaining from cleaning operation.
 - c. Remove laitance and form-release agents from concrete.
2. Prime substrates where recommended in writing by joint firestopping system manufacturer using that manufacturer's recommended products and methods. Confine primers to areas of bond; do not allow spillage and migration onto exposed surfaces.
3. Apply a suitable bond-breaker to prevent three-sided adhesion in applications where this condition occurs, such as the intersection of a gypsum wall to floor or roof assembly where the joint is backed by a steel ceiling runner or track.

C.4.3 INSTALLATION

1. General: Install joint firestopping systems to comply with manufacturer's written installation instructions and published drawings for products and applications indicated.
2. Install forming materials and other accessories of types required to support elastomeric fill materials during their application and in position needed to produce cross-sectional shapes and depths required to achieve fire ratings indicated.
 - a. After installing elastomeric fill materials and allowing them to fully cure, remove combustible forming materials and other accessories not indicated as permanent components of fire-resistive joint system.
3. Install elastomeric fill materials for joint firestopping systems by proven techniques to produce the following results:
 - a. Elastomeric fill voids and cavities formed by joints and forming materials as required to achieve fire-resistance ratings indicated.
 - b. Apply elastomeric fill materials so they contact and adhere to substrates formed by joints.

- c. For elastomeric fill materials that will remain exposed after completing the Work, finish to produce smooth, uniform surfaces that are flush with adjoining finishes.

C.4.4 IDENTIFICATION

1. Wall Identification: Permanently label walls containing firestopping systems with the words "FIRE AND/OR SMOKE BARRIER - PROTECT ALL OPENINGS," using lettering not less than 3 inches (76 mm) high and with minimum 0.375-inch (9.5-mm) strokes.
 - a. Locate in accessible concealed floor, floor-ceiling, or attic space at 15 feet (4.57 m) from end of wall and at intervals not exceeding 30 ft. (9.14 m).
2. Joint Identification: Identify joint firestopping systems with legible metal or plastic labels. Attach labels permanently to surfaces adjacent to and within 6 inches (150 mm) of joint edge so labels are visible to anyone seeking to remove or joint firestopping system. Use mechanical fasteners or self-adhering-type labels with adhesives capable of permanently bonding labels to surfaces on which labels are placed. Include the following information on labels:
 - a. The words "Warning - Joint Firestopping - Do Not Disturb. Notify Building Management of Any Damage."
 - b. Contractor's name, address, and phone number.
 - c. Designation of applicable testing agency.
 - d. Date of installation.
 - e. Manufacturer's name.
 - f. Installer's name.

C.4.5 FIELD QUALITY CONTROL

1. Owner will engage a qualified testing agency to perform tests and inspections according to ASTM E2393.
2. Where deficiencies are found or joint firestopping systems are damaged or removed due to testing, repair or replace joint firestopping systems so they comply with requirements.
3. Proceed with enclosing joint firestopping systems with other construction only after inspection reports are issued and installations comply with requirements.

C.4.6 CLEANING AND PROTECTION

1. Clean off excess elastomeric fill materials adjacent to joints as the Work progresses by methods and with cleaning materials that are approved in writing by joint firestopping system manufacturers and that do not damage materials in which joints occur.
2. Provide final protection and maintain conditions during and after installation that ensure joint firestopping systems are without damage or deterioration at time of Substantial Completion. If damage or deterioration occurs despite such protection, cut out and remove damaged or deteriorated joint firestopping systems immediately and install new materials to produce joint firestopping systems complying with specified requirements.

C.4.7 JOINT FIRESTOPPING SYSTEM SCHEDULE

1. Where UL-classified systems are indicated, they refer to system numbers in UL's online directory "Product iQ" under product Category XHBN or Category XHDG.
2. Where Intertek Group-listed systems are indicated, they refer to design numbers in Intertek Group's "Directory of Building Products" under product category Expansion/Seismic Joints or Firestop Systems.
3. Floor-to-Floor, Joint Firestopping Systems FRJS:-
 - a. UL-Classified Systems: FF- D S0000-0999 1000-1999 2000-2999 3000-3999 4000-4999.
 - b. Assembly Rating: 2 hours
 - c. Nominal Joint Width: As indicated.

- d. Movement Capabilities: Class I Class II Class III - percent compression or extension compression, extension, or horizontal shear.
 - e. L-Rating at Ambient: Less than 0.001 cfm/ft. (cu. m/s x m)>.
 - f. L-Rating at 400 Deg F (204 Deg C): Less than 0.001 cfm/ft. (cu. m/s x m)>.
 - g. W-Rating: No leakage of water at completion of water leakage testing.
4. Wall-to-Wall, Joint Firestopping Systems FRJS-:
- a. UL-Classified Systems: WW- D S 0000-0999 1000-1999 2000-2999 3000-3999 4000-4999.
 - b. Assembly Rating: 2 hours
 - c. Nominal Joint Width: As indicated.
 - d. Movement Capabilities: Class I Class II Class III - percent compression or extension.
 - e. L-Rating at Ambient: Less than 0.001 cfm/ft. (cu. m/s x m)>.
 - f. L-Rating at 400 Deg F (204 Deg C): Less than 0.001 cfm/ft. (cu. m/s x m)>.
5. Floor-to-Wall, Joint Firestopping Systems FRJS-:
- a. UL-Classified Systems: FW- D S0000-0999 1000-1999 2000-2999 3000-3999 4000-4999.
 - b. Assembly Rating: 2 hours
 - c. Nominal Joint Width: As indicated.
 - d. Movement Capabilities: Class I Class II Class III - percent compression or extension compression, extension, or horizontal shear.
 - e. L-Rating at Ambient: Less than 0.001 cfm/ft. (cu. m/s x m)>.
 - f. L-Rating at 400 Deg F (204 Deg C): Less than 0.001 cfm/ft. (cu. m/s x m)>.
6. Head-of-Wall, Fire-Resistive Joint Firestopping Systems FRJS-<#>:
- a. UL-Classified Systems: HW- D S- 0000-0999 1000-1999 2000-2999 3000-3999 4000-4999.
 - b. Intertek Group-Listed Systems:
 - c. Assembly Rating: 2 hours
 - d. Nominal Joint Width: As indicated.
 - e. Movement Capabilities: Class I Class II Class III - percent compression or extension.
 - f. L-Rating at Ambient: Less than 0.001 cfm/ft. (cu. m/s x m)>.
 - g. L-Rating at 400 Deg F (204 Deg C): Less than 0.001 cfm/ft. (cu. m/s x m)>.
7. Bottom-of-Wall, Joint Firestopping Systems FRJS-:
- a. UL-Classified Systems: BW- D S0000-0999 1000-1999 2000-2999 3000-3999 4000-4999.
 - b. Assembly Rating: 1 hour 2 hours
 - c. Nominal Joint Width: As indicated.
 - d. Movement Capabilities: Class I Class II Class III - percent compression or extension.
 - e. L-Rating at Ambient: Less than 0.001 cfm/ft. (cu. m/s x m)>.
 - f. L-Rating at 400 Deg F (204 Deg C): Less than 0.001 cfm/ft. (cu. m/s x m)>.
8. Wall-to-Wall, Joint Firestopping Systems Intended for Use as Corner Guards FRJS-:
- a. UL-Classified Systems: CG- D S0000-0999 1000-1999 2000-2999 3000-3999 4000-4999.
 - b. Assembly Rating: 2 hours
 - c. Nominal Joint Width: As indicated.
 - d. Movement Capabilities: Class I Class II Class III - percent compression or extension.

9. Perimeter Joint Firestopping Systems PFRJS-~~<#>~~:
 - a. UL-Classified Perimeter Fire-Containment Systems: CW- D S0000-0999 1000-1999 2000-2999.
 - b. Intertek Group-Listed, Perimeter Fire-Barrier Systems:
 - c. Integrity Rating: 2 hours
 - d. Insulation Rating: Zero hour 1/4 hour 3/4 hour 1 hour
 - e. Linear Opening Width: 2-1/2 inches (63 mm) 8 inches (203 mm) As indicated, maximum.
 - f. Movement Capabilities: Class I Class II Class III - percent compression or extension.
 - g. F-Rating: 2 hours

C.5 Joint Sealants

C.5.1 EXAMINATION

1. Examine joints indicated to receive joint sealants, with Installer present, for compliance with requirements for joint configuration, installation tolerances, and other conditions affecting performance of the Work.
2. Proceed with installation only after unsatisfactory conditions have been corrected.

C.5.2 PREPARATION

1. Surface Cleaning of Joints: Clean out joints immediately before installing joint sealants to comply with joint-sealant manufacturer's written instructions and the following requirements:
 - a. Remove all foreign material from joint substrates that could interfere with adhesion of joint sealant, including dust, paints (except for permanent, protective coatings tested and approved for sealant adhesion and compatibility by sealant manufacturer), old joint sealants, oil, grease, waterproofing, water repellents, water, surface dirt, and frost.
 - b. Clean porous joint substrate surfaces by brushing, grinding, mechanical abrading, or a combination of these methods to produce a clean, sound substrate capable of developing optimum bond with joint sealants. Remove loose particles remaining after cleaning operations above by vacuuming or blowing out joints with oil-free compressed air. Porous joint substrates include the following:
 - i Concrete.
 - ii Masonry.
 - iii Unglazed surfaces of ceramic tile.
 - iv Exterior insulation and finish systems.
 - c. Remove laitance and form-release agents from concrete.
 - d. Clean nonporous joint substrate surfaces with chemical cleaners or other means that do not stain, harm substrates, or leave residues capable of interfering with adhesion of joint sealants. Nonporous joint substrates include the following:
 - i Metal.
 - ii Glass.
 - iii Porcelain enamel.
 - iv Glazed surfaces of ceramic tile.
2. Joint Priming: Prime joint substrates where recommended by joint-sealant manufacturer or as indicated by preconstruction joint-sealant-substrate tests or prior experience. Apply primer to comply with joint-sealant manufacturer's written instructions. Confine primers to areas of joint-sealant bond; do not allow spillage or migration onto adjoining surfaces.

3. Masking Tape: Use masking tape where required to prevent contact of sealant or primer with adjoining surfaces that otherwise would be permanently stained or damaged by such contact or by cleaning methods required to remove sealant smears. Remove tape immediately after tooling without disturbing joint seal.

C.5.3 INSTALLATION OF JOINT SEALANTS

1. General: Comply with joint-sealant manufacturer's written installation instructions for products and applications indicated, unless more stringent requirements apply.
2. Sealant Installation Standard: Comply with recommendations in ASTM C1193 for use of joint sealants as applicable to materials, applications, and conditions indicated.
3. Install sealant backings of type indicated to support sealants during application and at position required to produce cross-sectional shapes and depths of installed sealants relative to joint widths that allow optimum sealant movement capability.
 - a. Do not leave gaps between ends of sealant backings.
 - b. Do not stretch, twist, puncture, or tear sealant backings.
 - c. Remove absorbent sealant backings that have become wet before sealant application and replace them with dry materials.
4. Install bond-breaker tape behind sealants where sealant backings are not used between sealants and backs of joints.
5. Install sealants using proven techniques that comply with the following and at the same time backings are installed:
 - a. Place sealants so they directly contact and fully wet joint substrates.
 - b. Completely fill recesses in each joint configuration.
 - c. Produce uniform, cross-sectional shapes and depths relative to joint widths that allow optimum sealant movement capability.
6. Tooling of Nonsag Sealants: Immediately after sealant application and before skinning or curing begins, tool sealants according to requirements specified in subparagraphs below to form smooth, uniform beads of configuration indicated; to eliminate air pockets; and to ensure contact and adhesion of sealant with sides of joint.
 - a. Remove excess sealant from surfaces adjacent to joints.
 - b. Use tooling agents that are approved in writing by sealant manufacturer and that do not discolor sealants or adjacent surfaces.
 - c. Provide concave joint profile according to Figure 8A in ASTM C1193 unless otherwise indicated.
 - d. Provide flush joint profile at locations indicated on Drawings according to Figure 8B in ASTM C1193.
 - e. Provide recessed joint configuration of recess depth and at locations indicated on Drawings according to Figure 8C in ASTM C1193.
 - i. Use masking tape to protect surfaces adjacent to recessed tooled joints.

C.5.4 FIELD QUALITY CONTROL

1. Testing Agency: Owner will engage Engage a qualified testing agency to perform tests and inspections.
2. Tests and Inspections:
 - a. Field-Adhesion Testing: Field test joint-sealant adhesion to joint substrates as follows:
 - i. Extent of Testing: Test completed, and cured sealant joints as follows:
 - 1) Perform 10 tests for the first 1000 ft. (300 m) of joint length for each kind of sealant and joint substrate.

- 2) Perform one test for each 1000 ft. (300 m) of joint length thereafter or one test per each floor per elevation.
 - ii Test Method: Test joint sealants according to Method A, Tail Procedure, in ASTM C1521.
 - 1) For joints with dissimilar substrates, verify adhesion to each substrate separately; extend cut along one side, verifying adhesion to opposite side. Repeat procedure for opposite side.
 - iii Inspect tested joints and report on the following:
 - 1) Whether sealants filled joint cavities and are free of voids.
 - 2) Whether sealant dimensions and configurations comply with specified requirements.
 - 3) Whether sealants in joints connected to pulled-out portion failed to adhere to joint substrates or tore cohesively. Include data on pull distance used to test each kind of product and joint substrate. Compare these results to determine if adhesion complies with sealant manufacturer's field-adhesion hand-pull test criteria.
 - iv Record test results in a field-adhesion-test log. Include dates when sealants were installed, names of persons who installed sealants, test dates, test locations, whether joints were primed, adhesion results and percent elongations, sealant material, sealant configuration, and sealant dimensions.
 - v Repair sealants pulled from test area by applying new sealants following same procedures used originally to seal joints. Ensure that original sealant surfaces are clean and that new sealant contacts original sealant.
- b. Evaluation of Field-Adhesion-Test Results: Sealants not evidencing adhesive failure from testing or noncompliance with other indicated requirements will be considered satisfactory. Remove sealants that fail to adhere to joint substrates during testing or to comply with other requirements. Retest failed applications until test results prove sealants comply with indicated requirements.
- i Prepare test and inspection reports.

C.5.5 CLEANING

1. Clean off excess sealant or sealant smears adjacent to joints as the Work progresses by methods and with cleaning materials approved in writing by manufacturers of joint sealants and of products in which joints occur.

C.5.6 PROTECTION

1. Protect joint sealants during and after curing period from contact with contaminating substances and from damage resulting from construction operations or other causes so sealants are without deterioration or damage at time of Substantial Completion. If, despite such protection, damage or deterioration occurs, cut out, remove, and repair damaged or deteriorated joint sealants immediately so installations with repaired areas are indistinguishable from original work.

D Measurement

The department will measure Other Architectural Work as a single unit for each project, acceptably completed.

E Payment

The department will pay for measured quantities at the contract unit price under the following bid item:

ITEM NUMBER	DESCRIPTION	UNIT
SPV.0060.29	Other Architectural Work	EACH

Payment is full compensation for furnishing and installation of all other architectural work in the project as described above.

50. Fire Suppression, Item SPV.0060.30.

A Description

This special provision describes the installation of the fire protection system.

A.1 Regulatory Requirements

1. State and Local Codes
2. Conform to all state and local code requirements.
3. Permits and Inspections
4. Obtain permits and request inspections from authority having jurisdiction and pay for all Permit fees incidental thereto.

A.2 Equipment Accessibility

Install equipment and materials to provide required access for servicing and maintenance. Coordinate the final location of concealed equipment and devices requiring access with final location of required access panels and doors. Allow ample space for removal of all parts that require replacement or servicing.

A.3 Installations

Coordinate Fire Protection installation with other building components. Verify all dimensions by field measurements. Arrange for chases, slots and openings in other building components to allow for fire protection system installations. Install fire protection equipment to facilitate maintenance and repair or replacement of equipment components.

A.4 Quality Assurance

1. Installer Qualifications:
 - a. Installer's responsibilities include designing, fabricating, and installing fire-suppression standpipes and providing professional engineering services needed to assume engineering responsibility. Base calculations on results of fire-hydrant flow test.
 - i Engineering Responsibility: Preparation of working plans, calculations, and field test reports by a qualified professional engineer.
2. Welding Qualifications: Qualify procedures and operators according to ASME Boiler and Pressure Vessel Code.
 - a. NFPA Standards: Fire-suppression standpipe equipment, specialties, accessories, installation, and testing shall comply with NFPA 14.

A.5 Delivery, Storage and Handling

Deliver materials for fire protection system with appropriate protective packaging with labels in place. Deliver pipes with factory-applied end caps. Maintain end caps through shipping, storage and handling to prevent pipe end damage and to prevent entrance of dirt, debris and moisture.

A.6 References

National Fire Protection Association (NFPA)

1. NFPA 14 Standard for the Installation of Standpipe and Hose Systems
2. NFPA 255 Building Materials, Test of Surface Burning Characteristics

American Society for Testing & Materials (ASTM)

1. ASTM A90 Test Method for Weight of Coating on Zinc-Coated (Galvanized Iron or Steel Articles).
2. ASTM A527 Specification for Steel Sheet, Zinc-Coated (Galvanized) by the Hot Dip Process, Lock Forming Quality.
3. ASTM C553 Specification for Mineral Fiber Blanket and Felt Insulation (Industrial Type).

Underwriters Laboratories (UL)

American National Standards Institute (ANSI)

A.7 Submittals

A.7.1 Action Submittals

Product Data: For each type of product. Include rated capacities, operating characteristics, and furnished specialties and accessories.

1. Shop Drawings: For fire-suppression standpipes.
 - a. Include plans, elevations, sections, and attachment details.

A.7.2 Information Submittals

Qualification Data: For Installer and professional engineer.

Welding Certificates

B Materials

B.1 Fire Suppression Standpipes

B.1.1 System Description

Manual Dry-Type, Class I Standpipe System: Includes NPS 2-1/2 hose connections. Does not have permanent water supply. Piping is dry. Water must be pumped into standpipes to satisfy demand.

B.1.2 Performance Requirements

Standard-Pressure, Fire-Suppression Standpipe System Component: Listed for 175-psig minimum working pressure.

B.1.3 Galvanized Pipe and Associated Fittings

1. Schedule 40: ASTM A 53/A 53M, Type E, Grade B; with factory- or field-formed ends to accommodate joining method.
2. Galvanized-Steel Pipe Nipples: ASTM A 733, made of ASTM A 53/A 53M or ASTM A 106/A 106M, Standard Weight, seamless steel pipe with threaded ends.
3. Galvanized, Gray-Iron Threaded Fittings: ASME B16.4, Class 125, standard pattern.
4. Malleable-Iron Unions:
 - a. ASME B16.39, Class 150.
 - b. Hexagonal-stock body.
 - c. Ball-and-socket, metal-to-metal, bronze seating surface.
 - d. Threaded ends.
5. Flanges: ASME B16.1, Class 125, cast iron.
6. Appurtenances for Grooved-End, Galvanized-Steel Pipe:
 - a. Fittings for Grooved-End, Galvanized-Steel Pipe: Galvanized, ASTM A 47/A 47M, malleable-iron casting; ASTM A 106/A 106M, steel pipe; or ASTM A 536, ductile-iron casting; with dimensions matching steel pipe.
 - b. Fittings for Grooved-End, Galvanized-Steel Pipe:
 - i. AWWA C606 for steel-pipe dimensions.
 - ii. Ferrous housing sections.
 - iii. EPDM-rubber gaskets suitable for hot and cold water.
 - iv. Bolts and nuts.
 - v. Minimum Pressure Rating: 600 psig

B.1.4 Piping Joint Materials

Pipe-Flange Gasket Materials: AWWA C110, rubber, flat face, 1/8 inch thick or ASME B16.21, nonmetallic and asbestos free.

1. Class 125, Cast-Iron Flanges and Class 150, Bronze Flat-Face Flanges: Full-face gaskets.
 - a. Metal, Pipe-Flange Bolts and Nuts: ASME B18.2.1, carbon steel unless otherwise indicated.

B.1.5 Hose Connection

Adjustable-Valve Hose Connections:

1. Manufacturers:
 - a. Potter Roemer
 - b. Croker Fire Prevention
 - c. Guardian Fire Equipment, Inc.
 - d. American Fire Supply
2. Standard: UL 668 hose valve, with integral UL 1468 reducing or restricting pressure-control device, for connecting fire hose.
3. Pressure Rating: 300 psig minimum.
4. Material: Brass or bronze.
5. Inlet: Female pipe threads.
6. Outlet: Male hose threads with lugged cap, gasket, and chain. Include hose valve threads according to NFPA 1963 and matching local fire-department threads.
7. Pattern: Angle.
8. Finish: Rough brass or bronze.

B.1.6 Fire Department Connections (Siamese)

1. Siamese connections shall be twoway type, having a brass body, with clapper valves, hose thread swivels and red painted plugs, as required by local code. Provide the siamese connections with breakable caps, unless indicated otherwise on the Contract Drawings. Siamese connection escutcheon shall be lettered according to code requirements. Threads shall conform to local fire department requirements.
2. Flush type siamese connection shall be PotterRoemer Series 5020, or approved equal. Size and location of outlet shall be as shown on the Contract Drawings. Extra-heavy nipple extensions shall be installed to connect the yoke to the outside assembly.
3. Exposed type siamese connection shall be Potter-Roemer Series 5720 (back outlet) or 5730 (90° angle outlet) as shown on the Contract Drawings, or approved equal.
4. Size and location of outlet shall be as shown on the Contract Drawings.
5. Finish of siamese connection assembly including escutcheon shall be polished brass, unless otherwise shown on the Contract Drawings.
6. Siamese connections shall be manufactured by Potter-Roemer Inc., Elkhart Brass Manufacturing Co. Inc., Croker or approved equal.

B.2 Hangers and Support for Fire Protection Piping and Equipment

B.2.1 Performance requirements

Structural Performance: Hangers and supports for fire-suppression piping and equipment shall withstand the effects of gravity loads and stresses within limits and under conditions indicated according to ASCE/SEI 7.

1. NFPA Compliance: Comply with NFPA 14.
2. UL Compliance: Comply with UL 203.

B.2.2 Metal Pipe Hangers and Supports

Carbon-Steel Pipe Hangers and Supports:

1. Description: Factory-fabricated components, NFPA approved, UL listed, or FM approved for fire-suppression piping support.
2. Galvanized Metallic Coatings: Pre-galvanized or hot-dip galvanized.
3. Hanger Rods: Continuous-thread rod, nuts, and washer made of carbon steel.

B.2.3 Fastener Systems

Powder-Actuated Fasteners: NFPA-approved, UL-listed, or FM-approved threaded-steel stud, for use in hardened portland cement concrete, with pull-out, tension, and shear capacities appropriate for supported loads and building materials where used.

1. Mechanical-Expansion Anchors: NFPA-approved, UL-listed, or FM-approved, insert-wedge-type anchors, for use in hardened portland cement concrete; with pull-out, tension, and shear capacities appropriate for supported loads and building materials where used.
 - a. Applications: Zinc-coated or Stainless steel.

B.2.4 Materials

Carbon Steel: ASTM A 1011/A 1011M.

1. Structural Steel: ASTM A 36/A 36M, carbon-steel plates, shapes, and bars; black and galvanized.
2. Stainless Steel: ASTM A 240/A 240M.
3. Grout: ASTM C 1107/C 1107M, factory-mixed and -packaged, dry, hydraulic-cement, non-shrink and non-metallic grout, suitable for interior and exterior applications.
 - a. Properties: Non-staining, noncorrosive, and nongaseous.
 - b. Design Mix: 5000-psi, 28-day compressive strength.

B.3 Sleeves and Sleeve Seals For Fire Suppression Piping

B.3.1 Sleeves

Cast-Iron Pipe Sleeves: Cast or fabricated of cast or ductile iron and equivalent to ductile-iron pressure pipe, with plain ends and integral waterstop.

1. Steel Pipe Sleeves: ASTM A 53/A 53M, Type E, Grade B, Schedule 40, anticorrosion coated or galvanized, with plain ends and integral welded waterstop collar.
2. Galvanized-Steel Sheet Sleeves: 0.0239-inch minimum thickness; round tube closed with welded longitudinal joint.

B.3.2 Grout

Description: Nonshrink, for interior and exterior sealing openings in non-fire-rated walls or floors.

1. Standard: ASTM C 1107/C 1107M, Grade B, post-hardening and volume-adjusting, dry, hydraulic-cement grout.
2. Design Mix: 5000-psi, 28-day compressive strength.
3. Packaging: Premixed and factory packaged.

B.3.3 Silicone Sealants

Silicone, S, NS, 25, NT: Single-component, non-sag, plus 25 percent and minus 25 percent movement capability, nontraffic-use, neutral-curing silicone joint sealant, ASTM C 920, Type S, Grade NS, Class 25, Use NT.

1. Silicone, S, P, 25, T, NT: Single-component, pourable, plus 25 percent and minus 25 percent movement capability, traffic- and nontraffic-use, neutral-curing silicone joint sealant; ASTM C 920, Type S, Grade P, Class 25, Uses T and NT. Grade P Pourable (self-leveling) formulation is for opening in floors and other horizontal surfaces that are not fire rated.

B.4 Escutcheons For Fire-Suppression Piping

B.4.1 Manufacturers

1. Manufacturers: Subject to compliance with requirements, provide products by one of the following:
 - a. Keeney Manufacturing Company
 - b. Mid-Atlantoc Fittings, Inc.
 - c. ProFlo; a Ferguson Enterprise

B.4.2 Escutcheons

One-Piece, Steel Type: With polished brass finish and setscrew fastener.

1. One-Piece, Cast-Brass Type: With polished brass finish and setscrew fastener.
2. One-Piece, Stamped-Steel Type: With polished, chrome-plated finish and spring-clip fasteners.
3. Split-Plate, Stamped-Steel Type: With polished, chrome-plated finish; concealed and exposed-rivet hinge; and spring-clip fasteners.

B.4.3 Floor Plates

Split Floor Plates: Steel with concealed hinge.

C Construction

C.1 Piping Systems – Common Requirements

Install piping indicated to be exposed and piping in equipment rooms and service areas at right angles or parallel to building walls. Diagonal runs are prohibited unless specifically indicated otherwise.

Install piping free of sags and bends.

Install piping to allow application of insulation.

Select system components with pressure rating equal to or greater than system operating pressure.

Sleeves are required for core-drilled holes.

Install sleeves for pipes passing through concrete and masonry walls, gypsum-board partitions, and concrete floor and roof slabs.

Cut sleeves to length for mounting flush with both surfaces.

1. Exception: Extend sleeves installed in floors of mechanical equipment areas or other wet areas 2 inches above finished floor level. Extend cast-iron sleeve fittings below floor slab as required to secure clamping ring if ring is specified.

Install sleeves in new walls and slabs as new walls and slabs are constructed.

Install sleeves that are large enough to provide 1/4-inch annular clear space between sleeve and pipe or pipe insulation. Use the following sleeve materials:

Steel Pipe Sleeves: For pipes smaller than NPS 6.

1. Verify final equipment locations for roughing-in.

C.1.2 Piping Joint Construction

Join pipe and fittings according to the following requirements.

Ream ends of pipes and tubes and remove burrs. Bevel plain ends of steel pipe.

Remove scale, slag, dirt, and debris from inside and outside of pipe and fittings before assembly.

Soldered Joints: Apply ASTM B 813, water-flushable flux, unless otherwise indicated, to tube end. Construct joints according to ASTM B 828 or CDA's "Copper Tube Handbook," using lead-free solder alloy complying with ASTM B 32.

Brazed Joints: Construct joints according to AWS's "Brazing Handbook," "Pipe and Tube" Chapter, using copper-phosphorus brazing filler metal complying with AWS A5.8.

C.1.3 Equipment Installation – Common Requirements.

Install equipment to allow maximum possible headroom unless specific mounting heights are indicated.

Install equipment level and plumb, parallel and perpendicular to other building systems and components in exposed interior spaces, unless otherwise indicated.

Install mechanical equipment to facilitate service, maintenance, and repair or replacement of components. Connect equipment for ease of disconnecting, with minimum interference to other installations. Extend grease fittings to accessible locations.

Install equipment to allow right-of-way for piping installed at required slope.

C.1.4 Painting

Damage and Touchup: Repair marred and damaged factory-painted finishes with materials and procedures to match original factory finish.

C.2 Hangers and Support for Fire Protection Piping and Equipment

C.2.1 Application

Strength of Support Assemblies: Where not indicated, select sizes of components, so strength will be adequate to carry present and future static loads within specified loading limits. Minimum static design load used for strength determination shall be weight of supported components plus 200 lb.

C.2.2 Hanger and Support Installation

Metal Pipe-Hanger Installation: Comply with installation requirements of approvals and listings. Install hangers, supports, clamps, and attachments as required to properly support piping from building structure.

1. Fastener System Installation:

- a. Install powder-actuated fasteners for use in lightweight concrete or concrete slabs less than 4 inches thick in concrete, after concrete is placed and completely cured. Use operators that are licensed by powder-actuated tool manufacturer. Install fasteners according to powder-actuated tool manufacturer's operating manual. Install according to approvals and listings.
- b. Install mechanical-expansion anchors in concrete, after concrete is placed and completely cured. Install fasteners according to manufacturer's written instructions. Install according to approvals and listings.

2. Install hangers and supports complete with necessary attachments, inserts, bolts, rods, nuts, washers, and other accessories.
3. Install hangers and supports to allow controlled thermal and seismic movement of piping systems, to permit freedom of movement between pipe anchors, and to facilitate action of expansion joints, expansion loops, expansion bends, and similar units.
4. Install lateral bracing with pipe hangers and supports to prevent swaying.
5. Install building attachments within concrete slabs or attach to structural steel. Install additional attachments at concentrated loads, including valves, flanges, and strainers, NPS 2-1/2 and larger and at changes in direction of piping. Install concrete inserts before concrete is placed; fasten inserts to forms, and install reinforcing bars through openings at top of inserts.
6. Load Distribution: Install hangers and supports, so that piping live and dead loads and stresses from movement will not be transmitted to connected equipment.

C.2.3 Adjusting

Hanger Adjustments: Adjust hangers to distribute loads equally on attachments and to achieve indicated slope of pipe.

1. Trim excess length of continuous-thread hanger and support rods to 1-1/2 inch.

C.2.4 Painting

Touchup: Clean field welds and abraded, shop-painted areas. Paint exposed areas immediately after erecting hangers and supports. Use same materials as those used for shop painting. Comply with SSPC-PA 1 requirements for touching up field-painted surfaces.

1. Apply paint by brush or spray to provide a minimum dry film thickness of 2.0 mils.
2. Galvanized Surfaces: Clean welds, bolted connections, and abraded areas, and apply galvanizing-repair paint to comply with ASTM A 780/A 780M.

C.2.5 Hanger and Support Schedule

1. Specific hanger and support requirements are in Sections specifying piping systems and equipment.
 - a. Comply with NFPA requirements for pipe-hanger selections and applications that are not specified in piping system Sections.
 - b. Use hangers and supports with galvanized metallic coatings for piping and equipment that will not have field-applied finishes.
 - c. Use carbon-steel pipe hangers and supports and attachments for general service applications.
 - d. Horizontal-Piping Hangers and Supports: Comply with NFPA requirements. Unless otherwise indicated and except as specified in piping system Sections, install the following types:
 - i Adjustable, Steel Clevis Hangers (MSS Type 1): For suspension of noninsulated or insulated, stationary pipes NPS 1/2 to NPS 30.
 - ii Steel Pipe Clamps (MSS Type 4): For suspension of NPS 1/2 to NPS 24 if little or no insulation is required.
 - iii Adjustable, Swivel-Ring Band Hangers (MSS Type 10): For suspension of noninsulated, stationary pipes NPS 1/2 to NPS 8.
 - iv Split Pipe Ring with or without Turnbuckle Hangers (MSS Type 11): For suspension of noninsulated, stationary pipes NPS 3/8 to NPS 8.
 - v Extension Hinged or Two-Bolt Split Pipe Clamps (MSS Type 12): For suspension of noninsulated, stationary pipes NPS 3/8 to NPS 3.
 - vi U-Bolts (MSS Type 24): For support of heavy pipes NPS 1/2 to NPS 30.
 - e. Vertical-Piping Clamps: Unless otherwise indicated and except as specified in piping system Sections, install the following types:
 - i Extension Pipe or Riser Clamps (MSS Type 8): For support of pipe risers NPS 3/4 to NPS 24.
 - ii Carbon- or Alloy-Steel Riser Clamps (MSS Type 42): For support of pipe risers NPS 3/4 to NPS 24 if longer ends are required for riser clamps.
 - f. Hanger-Rod Attachments: Comply with NFPA requirements.
 - g. Building Attachments: Comply with NFPA requirements. Unless otherwise indicated and except as specified in piping system Sections, install the following types:
 - i Steel or Malleable-Concrete Inserts (MSS Type 18): For upper attachment to suspend pipe hangers from concrete ceiling.
 - ii C-Clamps (MSS Type 23): For structural shapes.
 - iii Side-Beam Brackets (MSS Type 34): For sides of steel or wooden beams.
 - h. Comply with NFPA requirements for trapeze pipe-hanger selections and applications that are not specified in piping system Sections.
 - i. Comply with MFMA-103 for metal framing system selections and applications that are not specified in piping system Sections.

2. Use powder-actuated fasteners or mechanical-expansion anchors instead of building attachments where required in concrete construction.

C.3 Sleeves and Sleeve Seals For Fire Suppression Piping

C.3.1 Sleeve Installation

Install sleeves for piping passing through penetrations in floors, partitions, roofs, and walls. For sleeves that will have sleeve-seal system installed, select sleeves of size large enough to provide 1-inch annular clear space between piping and concrete slabs and walls.

1. Sleeves are not required for core-drilled holes.
2. Install sleeves in concrete floors, concrete roof slabs, and concrete walls as new slabs and walls are constructed.
3. Permanent sleeves are not required for holes in slabs formed by molded-PE or -PP sleeves.
4. Cut sleeves to length for mounting flush with both surfaces.
5. Using grout or silicone sealant, seal space outside of sleeves in slabs and walls without sleeve-seal system.
6. Install sleeves for pipes passing through interior partitions.
7. Cut sleeves to length for mounting flush with both surfaces.
8. Install sleeves that are large enough to provide 1/4-inch annular clear space between sleeve and pipe or pipe insulation.
9. Seal annular space between sleeve and piping or piping insulation; use joint sealants appropriate for size, depth, and location of joint.
10. Fire-Resistance-Rated Penetrations, Horizontal Assembly Penetrations, and Smoke Barrier Penetrations: Maintain indicated fire or smoke rating of walls, partitions, ceilings, and floors at pipe penetrations. Seal pipe penetrations with fire- and smoke-stop materials.

C.3.2 Field Quality

Perform the following tests and inspections:

1. Leak Test: After allowing for a full cure, test sleeves and sleeve seals for leaks. Repair leaks and retest until no leaks exist.
2. Sleeves and sleeve seals will be considered defective if they do not pass tests and inspections.
3. Prepare test and inspection reports.

C.3.3 Sleeve and Sleeve Seal Schedule

Use sleeves and sleeve seals for the following piping-penetration applications:

1. Exterior Concrete Walls above Grade:
 - a. Piping Smaller Than NPS 6: Cast-iron pipe sleeves
2. Concrete Slabs above Grade:
 - a. Piping Smaller Than NPS 6: Steel pipe sleeves.
3. Interior Partitions:
 - a. Piping Smaller Than NPS 6: Steel pipe sleeves

C.4 Escutcheons For Fire-Suppression Piping

C.4.1 Installation

1. Install escutcheons for piping penetrations of walls, ceilings, and finished floors.
2. Install escutcheons with ID to closely fit around pipe, tube, and insulation of piping and with OD that completely covers opening.
3. Escutcheons for New Piping:

4. Piping with Fitting or Sleeve Protruding from Wall: One-piece, deep pattern
5. Bare Piping at Wall and Floor Penetrations in Finished Spaces: One-piece steel with polished brass finish.
6. Bare Piping at Wall and Floor Penetrations in Finished Spaces: One-piece steel with polished brass finish.
7. Bare Piping at Wall and Floor Penetrations in Finished Spaces: One-piece stainless steel with polished stainless-steel finish.
8. Bare Piping at Wall and Floor Penetrations in Finished Spaces: One-piece cast brass with polished brass finish.
9. Bare Piping at Wall and Floor Penetrations in Finished Spaces: One-piece stamped steel or split-plate, stamped steel with exposed-rivet hinge with polished, chrome-plated finish.
10. Bare Piping at Ceiling Penetrations in Finished Spaces: One-piece steel with polished brass finish.
11. Bare Piping at Ceiling Penetrations in Finished Spaces: One-piece cast brass with polished brass finish.
12. Bare Piping in Unfinished Service Spaces: One-piece steel with polished, chrome-plated finish.
13. Install floor plates with ID to closely fit around pipe, tube, and insulation of piping and with OD that completely covers opening.
 - a. New Piping: One-piece, floor plate.

D Measurement

The department will measure Fire Suppression as a single unit for each project, acceptably completed.

E Payment

The department will pay for measured quantities at the contract unit price under the following bid item:

ITEM NUMBER	DESCRIPTION	UNIT
SPV.0060.30	Fire Suppression	EACH

Payment is full compensation for installing a fire suppression system.

51. PIDS, Communications, and Security Work, Item SPV.0060.31.

A Description

A.1 General

A.1.1 Summary

This special provision includes the requirements for the installation and testing of the PIDS, Communications, and CCTV Systems and equipment including conduit, sleeves, and cabling.

All head-end PIDS equipment will be installed in the equipment rack by others.

- 19" inch equipment rack and enclosure.
- Loudspeakers
- Electronic Signs
- Power and Communication Cabling to equipment from PIDS rack.
- NEMA 4X Enclosure (as required and shown on the Drawings).

Definitions

BICSI:	Building Industry Consulting Service International.
Consolidation Point:	A location for interconnection between horizontal cables extending from building pathways and horizontal cables extending into furniture pathways.
Cross-Connect:	A facility enabling the termination of cable elements and their interconnection or cross-connection.
CCTV	Closed Circuit Television
EMI:	Electromagnetic interference.
Horizontal Cable:	Cabling and its connecting hardware providing the means of transporting signals between the telecommunications outlet/connector and the patch panel located in the network closet or PIDS cabinet. This cabling and its connecting hardware are called a "permanent link," a term that is used in the testing protocols.
IDC:	Insulation displacement connector.
LAN:	Local area network.
Outlet/Connectors:	A connecting device in the work area on which horizontal cable or outlet cable terminates.
PIDS:	Passenger Information Display System
RCDD:	Registered Communications Distribution Designer.
UTP:	Unshielded twisted pair.

A.1.2 Related Sections:

- Sections relating to "Low Voltage Electrical Power Conductors and Cables"
- Sections relating to "Raceways and Boxes for Electrical Systems"

A.1.3 References

The following is a listing of the publications referenced in this Section:

1. Electronic Industries Association (EIA)
2. EIA-170 Electrical performance Standards - Monochrome Television Studio Facilities
3. EIA-232 Interface between Data Terminal Equipment and Data Circuit-Terminating Equipment Employing Serial Binary Data Interchange
4. EIA-250 Electrical Performance Standards for Television Relay Facilities
5. EIA-422 Electrical Characteristics of Balanced Voltage Digital Interface Circuits
6. National Fire Protection Association (NFPA)
7. NFPA 70 National Electrical Code
8. State of Wisconsin Building Code
9. Electrical Building Code

A.2 PIDS

A.2.1 Quality Assurance

1. Referenced Codes and Standards:
 - a. NEC 2017.
 - b. IBC 2018.

- c. TIA 568.
- d. NECA/FOA-301.
- e. Amtrak NPIDS Design Guide.
- f. Amtrak GnP PIDS Guidelines.
- g. Amtrak Station Program Planning Guidelines.
- h. Amtrak Signage Manual and Standards.
- i. Amtrak Premise Distribution System Standards – Cabling

A.2.2 Submittals

1. Product Data: For each type of product indicated. Include the following:
 - a. Construction details and dimensions.
 - b. Anchoring and mounting requirements, including requirements for cutouts in other work and substrate preparation.
 - c. Material and finish descriptions.
 - d. Features that will be included for Project.
 - e. Manufacturer's warranty.
2. Product Schedule: Indicating types, quantities, sizes, and installation locations.
 - a. Identify locations.
 - b. Identify products using designations indicated.
3. Maintenance Data: to include in maintenance manuals.

A.3 Pathways for Communications Systems

A.3.1 Submittals

1. Product Data: For surface pathways, wireways and fittings, floor boxes, hinged-cover enclosures, and cabinets.
2. Shop Drawings: For custom enclosures and cabinets.
3. Seismic Qualification Certificates: For pathway racks, enclosures, cabinets, equipment racks and their mounting provisions, including those for internal components, from manufacturer.

A.4 Sleeves and Sleeve Seals for Communications Pathways and Cabling

A.4.1 Related Requirements:

1. Action Submittals
 - a. Product Data: For each type of product.

A.5 Communication Horizontal Cabling

A.5.1 Administrative Requirements

1. Coordinate layout and installation of telecommunications cabling with Owner's telecommunications and LAN equipment and service suppliers.
2. Coordinate telecommunications outlet/connector locations with location of power receptacles at each work area.

A.5.2 Action Submittals

1. Product Data: For each type of product.
2. Shop Drawings:
 - a. System Labeling Schedules: Electronic copy of labeling schedules, in software and format selected by Owner.

- b. System Labeling Schedules: Electronic copy of labeling schedules that are part of the cabling and asset identification system of the software.
- c. Cabling administration drawings and printouts.
- d. Wiring diagrams to show typical wiring schematics, including the following:
 - i. Cross-connects.
 - ii. Patch panels.
 - iii. Patch cords.
- e. Cross-connects and patch panels. Detail mounting assemblies and show elevations and physical relationship between the installed components.

A.5.3 Informational Submittals

1. Qualification Data: For qualified layout technician, installation supervisor, and field inspector.
2. Source quality-control reports.
3. Field quality-control reports.

A.5.4 Closeout Submittals

1. Maintenance Data: For splices and connectors to include in maintenance manuals.
2. Software and Firmware Operational Documentation:
 - a. Software operating and upgrade manuals.
 - b. Program Software Backup: On magnetic media or compact disk, complete with data files.
 - c. Device address list.
 - d. Printout of software application and graphic screens.
3. Furnish extra materials that match products installed and that are packaged with protective covering for storage and identified with labels describing contents.
 - a. Patch-Panel Units: One of each type.
 - b. Connecting Blocks: One of each type.
 - c. Device Plates: One of each type.
 - d. Multiuser Telecommunications Outlet Assemblies: One of each type.

A.5.5 Quality Assurance

1. Installer Qualifications: Cabling Installer must have personnel certified by BICSI or another state or local agency.
 - a. Layout Responsibility: Preparation of Shop Drawings by a RCDD or an engineer registered with a state or local agency.
 - b. Installation Supervision: Installation and testing shall be under the direct supervision of Level 2 Installer, who shall be present at all times when Work of this Section is performed at Project site.
 - c. Testing: Each cable must be tested and then certified by the on-site Level 2 Installer.
2. Testing Agency Qualifications:
 - a. Post Installation Testing: Will be handled by the PIDS Commissioning Agent that is certified by a state or local agency to complete the cabling testing.

A.5.6 Delivery, Storage, and Handling

1. Test cables upon receipt at Project site.
 - a. Test optical fiber cables to determine the continuity of the strand end to end. Use optical fiber flashlight.

- b. Test optical fiber cables while on reels. Use an optical time domain reflectometer to verify the cable length and locate cable defects, splices, and connector, including the loss value of each. Retain test data and include the record in maintenance data.
- c. Test each pair of UTP cable for open and short circuits.

A.6 Close Circuit Television (CCTV)

A.6.1 Design and Performance Requirements

1. Unless otherwise specified on the Contract Drawings or in this Section, the Closed Circuit Television System, hereinafter referred to as the "System," manufactured, supplied, and installed shall conform to the requirements of NFPA 70, all local codes, all other publications referenced in Article 1.02 herein.
2. The electrical and electronic hardware, structural materials, and equipment housings, required for fully operational, integrated, real-time System shall operate on a 24 hour per day, 7 day per week basis with high system reliability of 99.7 percent and shall conform to the requirements of this Section.
3. The System shall be composed of all items of hardware necessary to generate, transmit, and effect the display of changeable message text on fiberoptic sign panels as specified herein and as shown on the Contract Drawings. In general, the System shall consist of readily available, reliable and proven hardware, software, and firmware elements which fully comply with the requirements of this Section and the Contract Drawings. All of the Work of this Section shall be coordinated with the current operation of the facility.
4. Provide video communications between the points of surveillance and the location(s) of the CCTV monitor(s) specified on the Contract Drawings.
 - a. Cameras: The number of CCTV cameras to be supplied shall be as shown on the Contract Drawings.
 - b. Configuration: Unless otherwise specified on the Contract Drawings, the configuration of the CCTV system shall conform to EIA-250, with 1 volt peak-to-peak across 75 ohms.

A.6.2 Quality Assurance

1. Qualifications
 - a. Contractor: Demonstrate a minimum of five years' experience and technical expertise in performing contracts comparable in size and complexity, and that the work was performed skillfully in a satisfactory manner and on time. Submit a complete list, which shall consist of a minimum of three installations, one of which shall be located in the United States, which shall have included work, comparable in type, size, and complexity as described herein under Article I "Introduction." Said installations shall be in satisfactory operation for the last three consecutive years, minimum.
 - b. System Integrator: The system and its components shall be supplied by one System Integrator of established reputation and experience who shall have furnished and provided technical assistance and shall have performed systems integration for the installation of CCTV Systems for that last three consecutive years and shall demonstrate prior experience on at least two projects of similar size and complexity to what is required under this Contract.
 - c. Equipment: CCTV equipment shall have been satisfactorily used in projects of similar size and complexity for not less than two years.

A.6.3 Delivery, Storage, and Handling

1. Contractor shall:
 - a. Deliver materials in manufacturer's original, unopened, protective packaging.
 - b. Store materials in a clean, dry space, protected from weather.
 - c. Handle in a manner to prevent damage to finished surfaces.
 - d. Where possible, maintain protective covering until installation is complete and remove such coverings as part of final cleanup.

- e. Touchup damage to finishes to match adjacent surfaces, including recoating of galvanized or plated surfaces where damaged, cut, or drilled.

A.6.4 Submittals

1. Estimated progress schedule of dates for the Work to include (but not necessarily be limited to) the following:
 - a. Project start
 - b. Shop drawing submittal
 - c. Shop drawing approval
 - d. On-site rough-in start
 - e. Training Curricula submittal
 - f. Training Curricula approval
 - g. On-site rough-in completion
 - h. Recommended spare parts list
 - i. Proof of performance testing
 - j. Acceptance testing
 - k. Completion/Resolution of all submittals and/or punch list items
 - l. Record documents submittal
 - m. Final Acceptance
2. Complete Bill of Materials.
3. Shop Drawings
 - a. System Block Diagram
 - b. Detailed System Wiring Diagrams, indicating all field terminal block numbers
 - c. Complete, comprehensive, single-line diagrams, including all equipment, devices, and cabling completely identified.
 - d. System Logic Program
 - e. Command Description and Language
 - f. Wire
 - g. Enclosures and all Devices
4. Catalog Cuts
 - a. CCTV Cameras
 - b. CCTV Camera Mounts
 - c. CCTV Camera Enclosures
 - d. CCTV Camera Lenses
 - e. Wire and Cable associated with the installation of the CCTV system
 - f. Cable connectors
5. Spare Parts: Submit a complete list of recommended spare parts, which shall include those spare parts required to be furnished in compliance with the requirements of this Section, for approval by the engineer.
6. Performance Testing Plan: Prepare and submit to the engineer for approval a performance testing plan for the entire system a minimum of 30 days in advance of the earliest, approved, scheduled inspection and test date. The system test plan shall be divided into the following stages:

- a. Inspection of the System upon arrival.
 - b. On-site inspection and test immediately following the complete installation of the system, to demonstrate compliance with the requirements of this Section.
 - c. A 30-day operational test commencing with the successful completion of the on-site inspection and test, approved by the engineer.
7. Record Documents: Prior to the issuance of the Certificate of Final Completion, deliver to the engineer the following:
- a. One reproducible set of the Contract Drawings and Shop Drawings, which reflect actual locations and actual wiring details of system equipment and all revisions to the Work of this Section. In addition, nine sets of prints of said Contract Drawings and Shop Drawings shall be supplied to the engineer. Three copies of said drawings shall be marked to the attention of the Facility Supervisor of Electrical Maintenance.
8. System Documentation
9. The following shall be included in the complete documentation package on the system which shall be furnished at the time of delivery of the System.
- a. Software Documentation
 - i. Three complete sets of documentation shall be submitted, explaining all system capabilities and options, including system set-up, operation, and maintenance (software manuals shall be supplied in hard copy only).
 - b. Hardware Documentation
 - i. Three complete sets of system manuals shall be submitted explaining all system capabilities and options, including but not limited to the installation, set-up, operation, and maintenance of all equipment furnished.
 - c. Operational Documentation
 - i. Twelve complete sets of system operations manuals shall be submitted which shall consist of the following:
 - 1) Operations Run Book (To be supplied in hardcopy only)
 - 2) Detailed description of normal system operation
 - 3) Error and Alarm handling Procedures
 - 4) System Start up and Shutdown Procedures
 - 5) Use of Various Logs and Output Data by Operator to Improve System Efficiency
 - 6) Description of Operating Procedure and Troubleshooting Procedures for each subsystem
 - 7) System Backup Procedures
 - d. Test Procedures
 - i. Recommended system test procedures shall be no less than thirty days prior to scheduled factory test date.
 - ii. Test shall include the following:
 - 1) Factory test of system as witnessed by the WisDOT.
 - 2) Field test of system prior to connection to substation components as witnessed by the WisDOT.
 - 3) Thirty day field performance test in which system shall operate without failure. If a failure is encountered, the 30-day test shall be restarted from the beginning.

B Materials

B.1 PIDS

B.1.1 Communication Cabling

1. Approved Manufacturers:
 - a. General Cable.
 - b. Belden.
 - c. Commscope.
 - d. Corning.
2. Category 6:
 - a. Unshielded Twisted Pair (UTP), 4 pair, solid core, 22 to 24 AWG
3. Optical Fiber:
 - a. Singlemode Fiber, OS2
 - i. Strand/Cladding Diameter: 9/125 μm
 - b. Multimode Fiber, OM2
 - i. Strand/Cladding Diameter: 50/125 mm μm
4. Audio Cable:
 - a. Stranded, bare copper conductors.
 - b. Wire gauge per Contract Drawings.
 - c. UL Listed.

B.2 Pathways for Communications Systems

B.2.1 Metal Conduits and Fittings

1. General Requirements for Metal Conduits and Fittings:
 - a. Listed and labeled as defined in NFPA 70, by a qualified testing agency, and marked for intended location and application.
 - b. Comply with TIA-569.
2. GRC: Comply with ANSI C80.1 and UL 6.
3. EMT: Comply with ANSI C80.3 and UL 797.
4. Fittings for Metal Conduit: Comply with NEMA FB 1 and UL 514B.
 - a. Conduit Fittings for Hazardous (Classified) Locations: Comply with UL 886 and NFPA 70.
 - i. Fittings for EMT:
 - 1) Material: Steel.
 - 2) Type: Compression.
 - b. Expansion Fittings: PVC or steel to match conduit type, complying with UL-467, rated for environmental conditions where installed, and including flexible external bonding jumper.
5. Joint Compound for GRC: Approved, as defined in NFPA 70, by authorities having jurisdiction for use in conduit assemblies, and compounded for use to lubricate and protect threaded conduit joints from corrosion and to enhance their conductivity.

B.2.2 Optical Fiber-Cable Pathways and Fittings

1. Description: Comply with UL 2024; flexible-type pathway, approved for plenum, riser or general-use installation unless otherwise indicated.

- a. Listed and labeled as defined in NFPA 70, by a qualified testing agency, and marked for intended location and application.
- b. Comply with TIA-569.

B.2.3 Surface Pathways

1. General Requirements for Surface Pathways:
 - a. Listed and labeled as defined in NFPA 70, by a qualified testing agency, and marked for intended location and application.
 - b. Comply with TIA-569.
2. Surface Metal Pathways: Galvanized steel with snap-on covers complying with UL 5. Manufacturer's standard enamel finish.

B.2.4 Boxes, Enclosures, and Cabinets

1. General Requirements for Boxes, Enclosures, and Cabinets:
 - a. Comply with TIA-569.
 - b. Boxes, enclosures and cabinets installed in wet locations shall be listed for use in wet locations.
2. Sheet-Metal Outlet and Device Boxes: Comply with NEMA OS 1 and UL 514A.
3. Box extensions used to accommodate new building finishes shall be of same material as recessed box.
4. Metal Floor Boxes:
 - a. Material: Cast metal.
 - b. Type: Semi-adjustable.
 - c. Listing and Labeling: Metal floor boxes shall be listed and labeled as defined in NFPA 70, by a qualified testing agency, and marked for intended location and application.
5. Nonmetallic Floor Boxes: Nonadjustable, rectangular.
 - a. Listing and Labeling: Nonmetallic floor boxes shall be listed and labeled as defined in NFPA 70, by a qualified testing agency, and marked for intended location and application.
6. Small Sheet Metal Pull and Junction Boxes: NEMA OS 1.
7. Device Box Dimensions: 4 inches square by 2-1/8 inches deep (100 mm square by 60 mm deep).
8. Gangable boxes are prohibited.
9. Nonmetallic Outlet and Device Boxes: Comply with NEMA OS 2 and UL 514C.
10. Hinged-Cover Enclosures: Comply with UL 50 and NEMA 250 with continuous-hinge cover with flush latch unless otherwise indicated.
 - a. Metal Enclosures: Steel, finished inside and out with manufacturer's standard enamel.
 - b. Nonmetallic Enclosures: Plastic or fiberglass finished inside with radio-frequency-resistant paint.
 - c. Interior Panels: Steel; all sides finished with manufacturer's standard enamel.
11. Cabinets:
 - a. NEMA 250, NEMA 4X, galvanized-steel box with removable interior panel and removable front, finished inside and out with manufacturer's standard enamel.
 - b. Hinged door in front cover with flush latch and concealed hinge.
 - c. Key latch to match panelboards.
 - d. Metal barriers to separate wiring of different systems and voltage.

- e. Accessory feet where required for freestanding equipment.
- f. Nonmetallic cabinets shall be listed and labeled as defined in NFPA 70, by a qualified testing agency, and marked for intended location and application.

B.3 Sleeves and Sleeve Seals for Communications Pathways and Cabling

B.3.1 Sleeves

1. Wall Sleeves:
 - a. Steel Pipe Sleeves: ASTM A 53/A 53M, Type E, Grade B, Schedule 40, zinc coated, plain ends.
 - b. Cast-Iron Pipe Sleeves: Cast or fabricated "wall pipe," equivalent to ductile-iron pressure pipe, with plain ends and integral waterstop unless otherwise indicated.
2. Sleeves for Conduits Penetrating Non-Fire-Rated Gypsum Board Assemblies: Galvanized-steel sheet; 0.0239-inch minimum thickness; round tube closed with welded longitudinal joint, with tabs for screw-fastening the sleeve to the board.
3. PVC-Pipe Sleeves: ASTM D 1785, Schedule 40.
4. Molded-PVC Sleeves: With nailing flange for attaching to wooden forms.
5. Molded-PE or -PP Sleeves: Removable, tapered-cup shaped, and smooth outer surface with nailing flange for attaching to wooden forms.
6. Sleeves for Rectangular Openings:
 - a. Material: Galvanized-steel sheet.
 - b. Minimum Metal Thickness:
 - i For sleeve cross-section rectangle perimeter less than 50 inches and with no side larger than 16 inches, thickness shall be 0.052 inch.
 - ii For sleeve cross-section rectangle perimeter 50 inches or more and one or more sides larger than 16 inches, thickness shall be 0.138 inch.

B.3.2 Sleeve-Seal Systems

1. Description: Modular sealing device, designed for field assembly, to fill annular space between sleeve and pathway or cable.
 - a. Manufacturers: Subject to compliance with requirements, provide products by one of the following:
 - i Advance Products & Systems, Inc. (Basis of Design).
 - ii CALPICO, Inc.
 - iii Metraflex Company (The)
 - iv Pipeline Seal and Insulator, Inc.
 - v Proco Products, Inc.
 - vi Or Approved Equal
 - b. Sealing Elements: EPDM rubber interlocking links shaped to fit surface of pipe. Include type and number required for pipe material and size of pipe.
 - c. Pressure Plates: Carbon steel.
 - d. Connecting Bolts and Nuts: Carbon steel, with corrosion-resistant coating, of length required to secure pressure plates to sealing elements.

B.3.3 Sleeve-Seal Fittings

1. Description: Manufactured plastic, sleeve-type, waterstop assembly made for embedding in concrete slab or wall. Unit shall have plastic or rubber waterstop collar with center opening to match piping OD.

2. Manufacturers: Subject to compliance with requirements, provide products by one of the following:
 - a. Presealed Systems (Basis of Design).
 - b. Advance Products & Systems, Inc.
 - c. Or Approved Equal

B.3.4 Grout

1. Description: Nonshrink; recommended for interior and exterior sealing openings in non-fire-rated walls or floors.
2. Standard: ASTM C 1107/C 1107M, Grade B, post-hardening and volume-adjusting, dry, hydraulic-cement grout.
3. Design Mix: 5000-psi, 28-day compressive strength.
4. Packaging: Premixed and factory packaged.

B.3.5 Silicone Sealants

1. Silicone Sealants: Single-component, silicone-based, neutral-curing elastomeric sealants of grade indicated below.
 - a. Grade: Pourable (self-leveling) formulation for openings in floors and other horizontal surfaces that are not fire rated.
 - b. Sealant shall have VOC content of 250 g/L or less when calculated according to 40 CFR 59, Subpart D (EPA Method 24).
 - c. Sealant shall comply with the testing and product requirements of the California Department of Health Services' "Standard Practice for the Testing of Volatile Organic Emissions from Various Sources Using Small-Scale Environmental Chambers."
2. Silicone Foams: Multicomponent, silicone-based liquid elastomers that, when mixed, expand and cure in place to produce a flexible, non-shrinking foam.

B.4 Communication Horizontal Cabling

B.4.1 Horizontal Cabling Requirements

1. Horizontal cabling shall contain no more than one transition point or consolidation point between the horizontal cross-connect and the telecommunications outlet/connector.
2. Bridged taps and splices shall not be installed in the horizontal cabling.
3. Splitters shall not be installed as part of the optical fiber cabling.
4. The maximum allowable horizontal cable length for UTP cabling is 295 feet. This maximum allowable length does not include an allowance for the length of 16 feet to the workstation equipment or in the horizontal cross-connect.

B.4.2 Performance Requirements

1. General Performance: Horizontal cabling system shall comply with transmission standards in TIA-568.2 when tested according to test procedures of this standard.
2. Surface-Burning Characteristics: Comply with ASTM E 84; testing by a qualified testing agency. Identify products with appropriate markings of applicable testing agency.
 - a. Flame-Spread Index: 25 or less.
 - b. Smoke-Developed Index: 50 or less.
3. Electrical Components, Devices, and Accessories: Listed and labeled as defined in NFPA 70, by a qualified testing agency, and marked for intended location and application.
4. Grounding: Comply with ANSI J-STD-607-A.

B.4.3 Backboards

1. Backboards: Plywood, 3/4 by 48 by 96 inches (maximum).

B.4.4 UTP Cable

1. Manufacturers: Subject to compliance with requirements, provide products by one of the following:
 - a. ADC (Basis of Design).
 - b. Belden Inc.
 - c. Berk-Tek; a Nexans company
 - d. CommScope, Inc.
 - e. Or Approved Equal
2. Description: 100-ohm, four-pair UTP, covered with a blue thermoplastic jacket.
 - a. Comply with ICEA S-90-661 for mechanical properties.
 - b. Comply with TIA-568.2 for performance specifications.
 - c. Listed and labeled by an NRTL acceptable to authorities having jurisdiction as complying with UL 444 and NFPA 70 for the following types:
 - i. Communications, General Purpose: Type CM or CMG.
 - ii. Communications, Plenum Rated: Type CMP, complying with NFPA 262.
 - iii. Communications, Riser Rated: Type CMR, complying with UL 1666.
3. Category 6 Cable: Unshielded, Twisted Pair (UTP) consists of four (4) twisted pairs of 23 AWG solid bare annealed copper in PVC, polyolefin, polyethylene, or polypropylene insulation. Shall be plenum rated for plenum applications. Cable shall meet, or exceed, the following:
 - a. TIA 568.2
 - b. TIA 862
 - c. ISO/IEC 11801 Ed 2.0 (Class E)
 - d. ICEA S-102-700 (Category 6)
 - e. NEC/CEC Type CMR (UL 1666) for Non-plenum
 - f. RoHS Compliant Directive 2002/95/EC
 - g. UL 444
4. Category 6 Cable: Shielded, consists of four (4) twisted pairs of 23 AWG solid bare annealed copper and 24 AWG stranded tinned copper drain wire in PVC, polyolefin, polyethylene, or polypropylene insulation. Enclosed by an overall conductive polyester backed aluminum foil shield and PVC outer jacket. Shall be plenum rated for plenum applications. Cable shall meet, or exceed, the following:
 - a. TIA 568.2
 - b. TIA 862
 - c. ISO/IEC 11801 Ed 2.0 (Class E)
 - d. ICEA S-102-700 (Category 6)
 - e. ICEA S-116-732
 - f. NEC/CEC Type CMR (UL 1666) for Non-plenum
 - g. RoHS Compliant Directive 2002/95/EC
 - h. UL 444

B.4.5 UTP Cable Hardware

1. Manufacturers: Subject to compliance with requirements, provide products by one of the following:
 - a. ADC (Basis of Design).
 - b. American Technology Systems Industries, Inc.
 - c. Belden Inc.
 - d. Dynacom Inc. (Approved Equal)
 - e. or Approved Equal
2. General Requirements for Cable Connecting Hardware: Comply with TIA-568-B.2, IDC type, with modules designed for punch-down caps or tools. Cables shall be terminated with connecting hardware of same category or higher.
3. Connecting Blocks: 110-style IDC for Category 6. Provide blocks for the number of cables terminated on the block, plus 25 percent spare. Integral with connector bodies, including plugs and jacks where indicated.
4. Cross-Connect: Modular array of connecting blocks arranged to terminate building cables and permit interconnection between cables.
 - a. Number of Terminals per Field: One for each conductor in assigned cables.
5. Patch Panel: Modular panels housing multiple-numbered jack units with IDC-type connectors at each jack for permanent termination of pair groups of installed cables.
 - a. Number of Jacks per Field: One for each four-pair UTP cable indicated, plus spares and blank positions adequate to suit specified expansion criteria.
6. Jacks and Jack Assemblies: Modular, color-coded, eight-position modular receptacle units with integral IDC-type terminals.
7. Patch Cords: Factory-made, four-pair cables in 48-inch lengths; terminated with eight-position modular plug at each end.
 - a. Patch cords shall have bend-relief-compliant boots and color-coded icons to ensure Category 6 performance. Patch cords shall have latch guards to protect against snagging.
 - b. Patch cords shall have color-coded boots for circuit identification.

B.4.6 Optical Fiber Cable

1. Manufacturers: Subject to compliance with requirements, provide products by one of the following:
 - a. Belden Inc. (Basis of Design).
 - b. Berk-Tek; a Nexans company
 - c. CommScope, Inc.
 - d. Corning Cable Systems
 - e. Or Approved Equal
2. Description: Multimode, 50/125-micrometer, 2-fiber, tight buffer, optical fiber cable.
 - a. Comply with ICEA S-83-596 for mechanical properties.
 - b. Comply with TIA-568.3 for performance specifications.
 - c. Comply with TIA-492AAAB for detailed specifications.

- d. Listed and labeled by an NRTL acceptable to authorities having jurisdiction as complying with UL 444, UL 1651, and NFPA 70 for the following types:
 - i. General Purpose, Nonconductive: Type OFN or OFNG.
 - ii. Plenum Rated, Nonconductive: Type OFNP, complying with NFPA 262.
 - e. Maximum Attenuation: 3.50 dB/km at 850 nm; 1.5 dB/km at 1300 nm.
 - f. Minimum Modal Bandwidth: 160 MHz-km at 850 nm; 500 MHz-km at 1300 nm.
3. Jacket for Multimode Fiber:
- a. Jacket Color: Orange for 50/125-micrometer cable.
 - b. Cable cordage jacket, fiber, unit, and group color shall be according to TIA-598-C.
 - c. Imprinted with fiber count, fiber type, and aggregate length at regular intervals not to exceed 40 inches.
4. Description: Single-mode, 9/125-micrometer, 2-fiber, tight buffer, optical fiber cable.
- a. Comply with ICEA S-83-596 for mechanical properties.
 - b. Comply with TIA-568.3 for performance specifications.
 - c. Comply with TIA-492CAA for detailed specifications.
 - d. Listed and labeled by an NRTL acceptable to authorities having jurisdiction as complying with UL 444, UL 1651, and NFPA 70 for the following types:
 - i. General Purpose, Nonconductive: Type OFN or OFNG.
 - ii. Plenum Rated, Nonconductive: Type OFNP, complying with NFPA 262.
 - e. Maximum Attenuation: 0.5 dB/km at 1310 nm; 0.5 dB/km at 1550 nm.
5. Jacket for Single-Mode Fiber:
- a. Yellow for 9/125-micrometer cable.
 - b. Cable cordage jacket, fiber, unit, and group color shall be according to TIA-598.
 - c. Imprinted with fiber count, fiber type, and aggregate length at regular intervals not to exceed 40 inches.

B.4.7 Optical Fiber Cable Hardware

1. Manufacturers: Subject to compliance with requirements, provide products by one of the following:
 - a. ADC (Basis of Design).
 - b. American Technology Systems Industries, Inc.
 - c. Belden Inc.
 - d. Berk-Tek; a Nexans company
 - e. Or Approved Equal
2. Cross-Connects and Patch Panels: Modular panels housing multiple-numbered, duplex cable connectors.
 - a. Number of Connectors per Field: One for each fiber of cable or cables assigned to field, plus spares and blank positions adequate to suit specified expansion criteria.
3. Patch Cords: Factory-made, dual-fiber cables in 36-inch lengths.
4. Cable Connecting Hardware:
 - a. Comply with Optical Fiber Connector Intermateability Standards (FOCIS) specifications of TIA-604-2, TIA-604-3, and TIA-604-12. Comply with TIA-568.3.

- b. Quick-connect, simplex and duplex, Type SC connectors. Insertion loss not more than 0.75 dB.
- c. Type SFF connectors may be used in termination racks, panels, and equipment packages.

B.4.8 Telecommunications Outlet/Connectors

1. Jacks: 100-ohm, balanced, twisted-pair connector; four-pair, eight-position modular. Comply with TIA-568.1.
2. Workstation Outlets: Two-port-connector assemblies mounted in single faceplate.
 - a. Metal Faceplate: Stainless steel.
 - b. For use with snap-in jacks accommodating any combination of UTP and optical fiber work area cords.
 - i Flush mounting jacks, positioning the cord at a 45-degree angle.
 - c. Legend: Machine printed, in the field, using adhesive-tape label.

B.4.9 Ethernet Switches

1. Manufacturers: Subject to compliance with requirements, provide products by the following:
 - a. Cisco (Basis of Design).
 - b. RuggedCom (Approved Equal).
 - c. Or Approved Equal
2. Ethernet switches: 24 10/100/1000BASE-T ports and 2 fixed 10/100/1000BASE-T uplink ports:
 - a. Provide Cisco Catalyst 9300 or approved equal.

B.4.10 Grounding

1. Comply with ANSI J-STD-607-A.

B.4.11 Identification Projects

1. Comply with TIA-606 and UL 969 for labeling materials, including label stocks, laminating adhesives, and inks used by label printers.²

B.5 Close Circuit Television (CCTV)

B.5.1 Manufacturers

1. Subject to compliance with the requirements of this Section, provide the following of one of the manufacturers specified on the Contract Drawings:
 - a. CCTV Cameras
 - b. CCTV Camera Mounts
 - c. CCTV Camera Enclosures
 - d. CCTV Camera Lenses
 - e. CCTV Video Switchers
 - f. CCTV Video Motion Detectors

B.5.2 Equipment

1. General
 - a. All electrical materials and equipment for which there are established UL standards shall bear the UL label.
 - b. The CCTV equipment operating voltages shall be as specified on the Contract Drawings.

2. Camera(s)
 - a. Unless otherwise specified on the Contract Drawings, all cameras shall be enclosed in a protective or environmental housing. Housings shall be complete with all accessories as specified on the Contract Drawings.
 - b. Unless otherwise specified on the Contract Drawings, all cameras shall be monochrome, high performance, high resolution cameras with 2/3" format frame transfer image sensor and high sensitivity.
 - c. Unless otherwise specified on the Contract Drawings, each CCTV camera shall come with zoom lenses having automatic iris, which have focal lengths and apertures as specified on the Contract Drawings. The field of view shall be adjusted to the satisfaction of the engineer.
3. Mounts
 - a. Fixed camera mounts shall provide a non-vibrating, adjustable support for camera and enclosure.
 - b. Pan and tilt mounts, for direct control, shall be the heavy-duty type and shall be 100% compatible with the video switcher furnished by the contractor.

C Construction

C.1 PIDS

C.1.1 Installation

1. Install LCD monitors in the station locations shown on the Drawings.
2. Install the LED signs as shown on the Drawings.
3. Monitors shall be installed using the mounting brackets as indicated on the Contract Drawings.
4. Category 6.
 - a. Factory or field splices of the insulated conductors shall not be allowed.
 - b. Provide slack at each end of installed cable. Recommended slack is 10 feet in the service room, and 12 inches at outlets and equipment.
 - c. Maximum length of Category 6 cable shall be 295 feet.
 - d. Cable management system shall be used for cables interior to the PIDS rack.
 - e. Bends shall not exceed 4 times the 4 pair radius.
 - f. Install Category 6 cable to the location of the PID workstation as shown on the Contract Drawings.
5. Optical Fiber.
 - a. Maximum length of fiber optic cable shall be 6,560 feet.
6. Loudspeakers.
 - a. Install loudspeakers in the locations as shown on the Contract Drawings.
 - b. Install audio cables from loudspeakers to PIDS rack as shown on the Contract Drawings. Leave 3 feet of slack in the rack. Connect to loudspeaker taps as shown on the Contract Drawings.

C.1.2 Field Quality Control

1. LED Sign.
 - a. Perform physical inspection of the LED Sign and mounting brackets. Verify that the sign is securely fastened to the mounting brackets.
 - b. Perform Pixel test to verify that all LEDs are functional.

2. LCD Monitor Testing.
 - a. Perform physical inspection of the LCD monitor and enclosure. Verify that monitor is securely fastened to the enclosure and that the enclosure is securely fastened to the structure.
 - b. Perform Pixel test to verify that all pixels are functional.
3. Loudspeaker Testing.
 - a. Verify functionality of all loud speakers by utilizing pink noise to verify the bandwidth of the speakers.
4. Communication Cabling.
 - a. Utilize a network cabling tester to verify continuity and that all conductors of the Category 6 cable are terminated correctly and that there are no crossed pairs.
 - b. If crossed pairs or transposed conductors are detected, or cable fails continuity test, repair problem and repeat test.
 - c. Utilize a fiber optic loss meter to verify that optical fiber losses are less than the maximum values per EIA/TIA 568.
5. Field Quality Control
 - a. Provide written results in a report of items A-D above.
 - b. Provide documentation of field quality control; Provide test and inspection reports to including testing of each location from head end to and including display equipment, deficiencies detected, remedial action taken and observation of remedial action taken

C.2 Pathways for Communications Systems

C.2.1 Pathway Application

1. Outdoors: Apply pathway products as specified below unless otherwise indicated:
 - a. Exposed Conduit: GRS.
 - b. Concealed Conduit, Aboveground: GRS.
 - c. Connection to Vibrating Equipment (Including Transformers and Hydraulic, Pneumatic, Electric Solenoid, or Motor-Driven Equipment): LFMC.
 - d. Boxes and Enclosures, Aboveground: NEMA Type 4X stainless steel.
 - e. Installed Beneath Track: GRS with suitable Cooper E80 rating for the installation.
2. Indoors: Apply pathway products as specified below unless otherwise indicated:
 - a. Exposed, Not Subject to Physical Damage: EMT.
 - b. Exposed, Not Subject to Severe Physical Damage: EMT.
 - c. Exposed and Subject to Severe Physical Damage: GRS. Raceway locations include but are not limited to the following:
 - i Loading dock.
 - ii Areas used for traffic of mechanized carts, forklifts, and pallet-handling units.
 - d. Concealed in Ceilings and Interior Walls and Partitions: EMT.
 - e. Connection to Vibrating Equipment (Including Transformers and Hydraulic, Pneumatic, Electric Solenoid, or Motor-Driven Equipment): FMC, except use LFMC in damp or wet locations.
 - f. Damp or Wet Locations: GRS.
 - g. Boxes and Enclosures: NEMA Type 1, except use NEMA Type 4X in damp or wet locations.

3. Minimum Pathway Size:
 - a. Galvanized RMC and EMT – 3/4 inch trade size
 - b. FMC and LFMC – 3/4 inch trade size
4. Pathway Fittings: Compatible with pathways and suitable for use and location.
 - a. Galvanized RMC: Use threaded galvanized rigid metal conduit fittings unless otherwise indicated. Comply with NEMA FB 2.10.
 - b. EMT: Use compression, steel fittings. Comply with NEMA FB 2.10.
 - c. Flexible Conduit: Use only fittings listed for use with flexible conduit. Comply with NEMA FB 2.20.
5. Do not install aluminum conduits, boxes, or fittings in contact with concrete or earth.
6. Install surface pathways only where indicated on Drawings.
7. Do not install nonmetallic conduit where ambient temperature exceeds 120 deg F (49 deg C).

C.2.2 Installation

1. Comply with NECA 1, NECA 101, and TIA-569 for installation requirements except where requirements on Drawings or in this article are stricter. Comply with NECA 102 for aluminum pathways. Comply with NFPA 70 limitations for types of pathways allowed in specific occupancies and number of floors.
2. Keep pathways at least 6 inches (150 mm) away from parallel runs of flues and steam or hot-water pipes. Install horizontal pathway runs above water and steam piping.
3. Comply with requirements in Section "Hangers and Supports for Electrical Systems" for hangers and supports.
4. Arrange stub-ups so curved portions of bends are not visible above finished slab.
5. Install no more than the equivalent of two 90-degree bends in any pathway run. Support within 12 inches (300 mm) of changes in direction. Utilize long radius ells for all optical-fiber cables.
6. Conceal conduit and EMT within finished walls, ceilings, and floors unless otherwise indicated. Install conduits parallel or perpendicular to building lines.
7. Pathways Embedded in Slabs:
 - a. Run conduit larger than 1-inch (27-mm) trade size, parallel or at right angles to main reinforcement. Where at right angles to reinforcement, place conduit close to slab support. Secure pathways to reinforcement at maximum 10-foot (3-m) intervals.
 - b. Arrange pathways to cross building expansion joints at right angles with expansion fittings.
 - c. Arrange pathways to keep a minimum of 2 inches (50 mm) of concrete cover in all directions.
 - d. Do not embed threadless fittings in concrete unless specifically approved by Program Manager for each specific location.
8. Coat field-cut threads on PVC-coated pathway with a corrosion-preventing conductive compound prior to assembly.
9. Terminate threaded conduits into threaded hubs or with locknuts on inside and outside of boxes or cabinets. Install insulated bushings on conduits terminated with locknuts.
10. Install pathways square to the enclosure and terminate at enclosures with locknuts. Install locknuts hand tight plus 1/4 turn more.
11. Do not rely on locknuts to penetrate nonconductive coatings on enclosures. Remove coatings in the locknut area prior to assembling conduit to enclosure to assure a continuous ground path.
12. Spare Pathways: Install pull wires in empty pathways. Cap underground pathways designated as spare above grade alongside pathways in use.

13. Surface Pathways:
 - a. Install surface pathway for surface telecommunications outlet boxes only where indicated on Drawings.
14. Pathways for Optical-Fiber and Communications Cable: Install pathways as follows:
 - a. 3/4-Inch (21-mm) Trade Size and Smaller: Install pathways in maximum lengths of 50 feet (15 m).
 - b. 1-Inch (27-mm) Trade Size and Larger: Install pathways in maximum lengths of 75 feet (23 m).
 - c. Install with a maximum of two 90-degree bends or equivalent for each length of pathway unless Drawings show stricter requirements.
15. Install pathway sealing fittings at accessible locations according to NFPA 70 and fill them with listed sealing compound.
16. Locate seals so no fittings or boxes are between the seal and the following changes of environments. Seal the interior of all pathways at the following points:
 - a. Where conduits pass from warm to cold locations, such as boundaries of refrigerated spaces.
 - b. Where an underground service pathway enters a building or structure.
 - c. Where otherwise required by NFPA 70.
17. Expansion-Joint Fittings:
 - a. Install in each run of aboveground RMC and EMT conduit that is located where environmental temperature change may exceed 100 deg F (55 deg C) and that has straight-run length that exceeds 100 feet (30 m).
 - b. Install type and quantity of fittings that accommodate temperature change listed for each of the following locations:
 - i Outdoor Locations Not Exposed to Direct Sunlight: 125 deg F (70 deg C) temperature change.
 - ii Outdoor Locations Exposed to Direct Sunlight: 155 deg F (86 deg C) temperature change.
 - iii Indoor Spaces Connected with Outdoors without Physical Separation: 125 deg F (70 deg C) temperature change.
 - iv Attics: 135 deg F (75 deg C) temperature change.
18. Install fitting(s) that provide expansion and contraction for at least 0.00041 inch per foot of length of straight run per deg F (0.06 mm per meter of length of straight run per deg C) of temperature change for PVC conduits. Install fitting(s) that provide expansion and contraction for at least 0.000078 inch per foot of length of straight run per deg F (0.0115 mm per meter of length of straight run per deg C) of temperature change for metal conduits.
19. Install expansion fittings at all locations where conduits cross building or structure expansion joints.
20. Install each expansion-joint fitting with position, mounting, and piston setting selected according to manufacturer's written instructions for conditions at specific location at time of installation. Install conduit supports to allow for expansion movement.
21. Mount boxes at heights indicated on Drawings according to ADA requirements.
22. Horizontally separate boxes mounted on opposite sides of walls, so they are not in the same vertical channel.

C.2.3 Sleeve and Sleeve-Seal Installation for Communications Penetrations

1. Install sleeves and sleeve seals at penetrations of exterior floor and wall assemblies.

C.2.4 Protection

1. Protect coatings, finishes, and cabinets from damage or deterioration.

C.3 Sleeves and Sleeve Seals for Communications Pathways and Cabling

C.3.1 Sleeve Installation for Non-Fire-Related Electrical Penetrations

1. Comply with NECA 1.
2. Comply with NEMA VE 2 for cable tray and cable penetrations.
3. Sleeves for Conduits Penetrating Above-Grade Non-Fire-Rated Concrete and Masonry-Unit Floors and Walls:
 - a. Interior Penetrations of Non-Fire-Rated Walls and Floors:
 - i Seal annular space between sleeve and pathway or cable, using joint sealant appropriate for size, depth, and location of joint.
 - ii Seal space outside of sleeves with mortar or grout. Pack sealing material solidly between sleeve and wall so no voids remain. Tool exposed surfaces smooth; protect material while curing.
 - b. Use pipe sleeves unless penetration arrangement requires rectangular sleeved opening.
 - c. Size pipe sleeves to provide 1/4-inch annular clear space between sleeve and pathway or cable unless sleeve seal is to be installed or unless seismic criteria require different clearance.
 - d. Install sleeves for wall penetrations unless core-drilled holes or formed openings are used. Install sleeves during erection of walls. Cut sleeves to length for mounting flush with both surfaces of walls. Deburr after cutting.
 - e. Install sleeves for floor penetrations. Extend sleeves installed in floors 2 inches above finished floor level. Install sleeves during erection of floors.
4. Sleeves for Conduits Penetrating Non-Fire-Rated Gypsum Board Assemblies:
 - a. Use circular metal sleeves unless penetration arrangement requires rectangular sleeved opening.
 - b. Seal space outside of sleeves with approved joint compound for gypsum board assemblies.
5. Roof-Penetration Sleeves: Seal penetration of individual pathways and cables with flexible boot-type flashing units applied in coordination with roofing work.
6. Aboveground, Exterior-Wall Penetrations: Seal penetrations using steel pipe sleeves and mechanical sleeve seals. Select sleeve size to allow for 1-inch annular clear space between pipe and sleeve for installing mechanical sleeve seals.
7. Underground, Exterior-Wall and Floor Penetrations: Install cast-iron pipe sleeves. Size sleeves to allow for 1-inch annular clear space between pathway or cable and sleeve for installing sleeve-seal system.

C.3.2 Sleeve-Seal-System Installation

1. Install sleeve-seal systems in sleeves in exterior concrete walls and slabs-on-grade at pathway entries into building.
2. Install type and number of sealing elements recommended by manufacturer for pathway or cable material and size. Position pathway or cable in center of sleeve. Assemble mechanical sleeve seals and install in annular space between pathway or cable and sleeve. Tighten bolts against pressure plates that cause sealing elements to expand and make watertight seal.

C.3.3 Sleeve-Seal-Fitting Installation

1. Install sleeve-seal fittings in new walls and slabs as they are constructed.
2. Assemble fitting components of length to be flush with both surfaces of concrete slabs and walls. Position waterstop flange to be centered in concrete slab or wall.

3. Secure nailing flanges to concrete forms.
4. Using grout, seal the space around outside of sleeve-seal fittings

C.4 Communication Horizontal Cabling

C.4.1 Wiring Methods

1. Install cables in pathways and cable trays except within consoles, cabinets, desks, and counters. Conceal pathways and cables except in unfinished spaces.
 - a. Install plenum cable in environmental air spaces, including plenum ceilings.
2. Conceal conductors and cables in accessible ceilings, walls, and floors where possible.
3. Wiring within Enclosures:
 - a. Bundle, lace, and train conductors to terminal points with no excess and without exceeding manufacturer's limitations on bending radii.
 - b. Install lacing bars and distribution spools.
 - c. Install conductors parallel with or at right angles to sides and back of enclosure.

C.4.2 Installation of Cables

1. Comply with NECA 1.
2. General Requirements for Cabling:
 - a. Comply with TIA-568.1.
 - b. Comply with BICSI ITSIM, Ch. 6, "Cable Termination Practices."
 - c. Install 110-style IDC termination hardware unless otherwise indicated.
 - d. Terminate conductors; no cable shall contain unterminated elements. Make terminations only at indicated outlets, terminals, cross-connects, and patch panels.
 - e. Cables may not be spliced. Secure and support cables at intervals not exceeding 30 inches and not more than 6 inches from cabinets, boxes, fittings, outlets, racks, frames, and terminals.
 - f. Install lacing bars to restrain cables, to prevent straining connections, and to prevent bending cables to smaller radii than minimums recommended by manufacturer.
 - g. Bundle, lace, and train conductors to terminal points without exceeding manufacturer's limitations on bending radii, but not less than radii specified in BICSI ITSIM, "Cabling Termination Practices" Chapter. Install lacing bars and distribution spools.
 - h. Do not install bruised, kinked, scored, deformed, or abraded cable. Do not splice cable between termination, tap, or junction points. Remove and discard cable if damaged during installation and replace it with new cable.
 - i. Cold-Weather Installation: Bring cable to room temperature before de-reeling. Heat lamps shall not be used for heating.
 - j. In the communications equipment room, install a 10-foot- long service loop on each end of cable.
 - k. Pulling Cable: Comply with BICSI ITSIM, Ch. 4, "Pulling Cable." Monitor cable pull tensions.
3. UTP Cable Installation:
 - a. Comply with TIA-568.2.
 - b. Do not untwist UTP cables more than 1/2 inch from the point of termination to maintain cable geometry.

4. Optical Fiber Cable Installation:
 - a. Comply with TIA-568.3.
 - b. Cable may be terminated on connecting hardware that is rack or cabinet mounted.
5. Open-Cable Installation:
 - a. Install cabling with horizontal and vertical cable guides in telecommunications spaces with terminating hardware and interconnection equipment.
 - b. Suspend UTP cable not in a wireway or pathway a minimum of 8 inches above ceilings by cable supports not more than 60 inches apart.
 - c. Cable shall not be run through structural members or in contact with pipes, ducts, or other potentially damaging items.
6. Group connecting hardware for cables into separate logical fields.
7. Separation from EMI Sources:
 - a. Comply with BICSI TDMM and TIA-569 for separating unshielded copper voice and data communication cable from potential EMI sources, including electrical power lines and equipment.
 - b. Separation between open communications cables or cables in nonmetallic raceways and unshielded power conductors and electrical equipment shall be as follows:
 - i Electrical Equipment Rating Less Than 2 kVA: A minimum of 5 inches.
 - ii Electrical Equipment Rating between 2 and 5 kVA: A minimum of 12 inches.
 - iii Electrical Equipment Rating More Than 5 kVA: A minimum of 24 inches.
 - c. Separation between communications cables in grounded metallic raceways and unshielded power lines or electrical equipment shall be as follows:
 - i Electrical Equipment Rating Less Than 2 kVA: A minimum of 2-1/2 inches.
 - ii Electrical Equipment Rating between 2 and 5 kVA: A minimum of 6 inches.
 - iii Electrical Equipment Rating More Than 5 kVA: A minimum of 12 inches.
 - d. Separation between communications cables in grounded metallic raceways and power lines and electrical equipment located in grounded metallic conduits or enclosures shall be as follows:
 - i Electrical Equipment Rating Less Than 2 kVA: No requirement.
 - ii Electrical Equipment Rating between 2 and 5 kVA: A minimum of 3 inches.
 - iii Electrical Equipment Rating More Than 5 kVA: A minimum of 6 inches.
 - e. Separation between Communications Cables and Electrical Motors and Transformers, 5 kVA or HP and Larger: A minimum of 48 inches.
 - f. Separation between Communications Cables and Fluorescent Fixtures: A minimum of 5 inches.

C.4.3 Grounding

1. Install grounding according to BICSI TDMM, "Grounding, Bonding, and Electrical Protection" Chapter.
2. Comply with ANSI J-STD-607-A.
3. Locate grounding bus bar to minimize the length of bonding conductors. Fasten to wall allowing at least 2-inch clearance behind the grounding bus bar. Connect grounding bus bar with a minimum No. 4 AWG grounding electrode conductor from grounding bus bar to suitable electrical building ground.

4. Bond metallic equipment to the grounding bus bar, using not smaller than No. 6 AWG equipment grounding conductor.

C.4.4 Identification

1. Identify system components, wiring, and cabling complying with TIA-606.
 - a. Administration Class: 1.
 - b. Color-code cross-connect fields. Apply colors to voice and data service backboards, connections, covers, and labels.
2. Cabling Administration Drawings: Show building floor plans with cabling administration-point labeling. Identify labeling convention and show labels for telecommunications closets, backbone pathways and cables, terminal hardware and positions, horizontal cables, work areas and workstation terminal positions, grounding buses and pathways, and equipment grounding conductors. Follow convention of TIA-606. Furnish electronic record of all drawings, in software and format selected by Owner.
3. Cable and Wire Identification:
 - a. Label each cable within 4 inches of each termination and tap, where it is accessible in a cabinet or junction or outlet box, and elsewhere as indicated.
 - b. Label each terminal strip and screw terminal in each cabinet, rack, or panel.
 - i. Individually number wiring conductors connected to terminal strips and identify each cable or wiring group being extended from a panel or cabinet to a building-mounted device shall be identified with name and number of particular device as shown.
 - ii. Label each unit and field within distribution racks and frames.
 - iii. UTP cables shall be identified as to the cable function, whether used for Ethernet or video transmission.
 - c. Identification within Connector Fields in Equipment Rooms and Wiring Closets: Label each connector and each discrete unit of cable-terminating and connecting hardware. Where similar jacks and plugs are used for both voice and data communication cabling, use a different color for jacks and plugs of each service.
4. Labels shall be preprinted or computer-printed type with printing area and font color that contrasts with cable jacket color but still complies with requirements in TIA-606.
5. Cables use flexible vinyl or polyester that flex as cables are bent.

C.4.5 Field Quality Control

1. Testing Agency: Engage a qualified testing agency to perform tests and inspections.
2. Manufacturer's Field Service: Engage a factory-authorized service representative to test and inspect components, assemblies, and equipment installations, including connections.
3. Perform the following tests and inspections:
 - a. Visually inspect UTP and optical fiber cable jacket materials for NRTL certification markings. Inspect cabling terminations in communications equipment rooms for compliance with color-coding for pin assignments and inspect cabling connections for compliance with TIA-568.1.
 - b. Visually confirm Category 6, marking of outlets, cover plates, outlet/connectors, and patch panels.
 - c. Visually inspect cable placement, cable termination, grounding and bonding, equipment and patch cords, and labeling of all components.

- d. Test UTP backbone copper cabling for DC loop resistance, shorts, opens, intermittent faults, and polarity between conductors. Test operation of shorting bars in connection blocks. Test cables after termination but not cross-connection.
 - i. Test instruments shall meet or exceed applicable requirements in TIA-568.2. Perform tests with a tester that complies with performance requirements in "Test Instruments (Normative)" Annex, complying with measurement accuracy specified in "Measurement Accuracy (Informative)" Annex. Use only test cords and adapters that are qualified by test equipment manufacturer for channel or link test configuration.
- e. Optical Fiber Cable Tests:
 - i. Test instruments shall meet or exceed applicable requirements in TIA-568.1. Use only test cords and adapters that are qualified by test equipment manufacturer for channel or link test configuration.
 - ii. Link End-to-End Attenuation Tests:
 - 3) Horizontal and multimode backbone link measurements: Test at 850 or 1300 nm in 1 direction according to TIA-526-14-A, Method B, One Reference Jumper.
 - 4) Attenuation test results for backbone links shall be less than 2.0 dB. Attenuation test results shall be less than that calculated according to equation in TIA-568.1.
- f. Optical Fiber Cable Performance Tests: Perform optical fiber end-to-end link tests according to TIA-568.1 and TIA-568.3.
- g. Final Verification Tests: Perform verification tests for UTP and optical fiber systems after the complete communications cabling and workstation outlet/connectors are installed.
 - i. Voice Tests: These tests assume that dial tone service has been installed. Connect to the network interface device at the demarcation point. Go off-hook and listen and receive a dial tone. If a test number is available, make and receive a local, long distance, and digital subscription line telephone call.
 - ii. Data Tests: These tests assume the Information Technology Staff has a network installed and is available to assist with testing. Connect to the network interface device at the demarcation point. Log onto the network to ensure proper connection to the network.
- 4. Document data for each measurement. Data for submittals shall be printed in a summary report that is formatted similar to Table 10.1 in BICSI TDMM, or transferred from the instrument to the computer, saved as text files, and printed and submitted.
- 5. End-to-end cabling will be considered defective if it does not pass tests and inspections.
- 6. Prepare test and inspection reports.

C.5 Close Circuit Television (CCTV)

C.5.1 Examination

1. Inspect all System equipment, and accessories prior to installation. Replace any damaged items.
2. Ensure that the spaces where any electronic equipment is to be stored and/or installed is completely free from any foreign substances, such as concrete dust, water, or any other material that may otherwise be harmful to electronic equipment and connections. No allowances shall be made to the contractor for equipment damage or delays due to environmental/security damage.

C.5.2 Preparation

1. The contractor shall be responsible for field verification of dimensions and coordination of conduit entry and all other mounting conditions with the entity manufacturing the equipment.
2. The entity manufacturing the equipment shall provide on-site technical supervision and assistance during installation and interconnection of the system equipment installed by the contractor. Said supervision is to ensure the safety of the proper installation and operation of the system equipment, prior to the installed system beginning the 30-day operational test.

3. After the system equipment has been delivered, an on-site inspection will be made by the Engineer. If any equipment has been damaged or for any reason does not comply with the requirements of this Section, the contractor will be notified in writing, and shall be required to replace the equipment at his own cost and expense, even though the equipment has been previously inspected, tested, and approved for shipment. After such satisfactory replacement, the system shall be installed by the contractor.

C.5.3 Installation

1. Install all System equipment according to the manufacturer's written instructions in the locations shown on the Contract Drawings.
2. All control power and data communications wire shall be wired and harnessed within the equipment enclosures shown on the Contract Drawings.
3. All wiring shall be clearly labeled with function and wire identification number corresponding to the manufacturer's wiring diagrams and/or approved Shop Drawings.
4. Where external circuit connections are required, terminal blocks shall be provided, and the manufacturer's drawings must clearly identify the interconnection requirements including wire type to be used.
5. All wiring required to externally connect equipment lineups shall be installed by the electrical contractor.
6. Contractor interconnection wiring requirements shall be clearly identified on the "AS-BUILT" system drawings.

C.5.4 Field Tests

1. After installation, the equipment shall be tested to show compliance with this Section. The contractor shall submit the proposed testing procedure to the engineer for approval two weeks prior to proposed start of test. Said testing shall continue until the results are satisfactory to the engineer. Any repairs, construction, or modifications as required to comply with this Section shall be performed by the contractor without additional cost to the Authority.
2. After satisfactory completion of testing, a 30-day operational test shall commence. The contractor shall correct any malfunctions as they occur, said malfunctions including, but not being limited to, equipment failure or failure of the System to comply with this Section. After the contractor corrects a malfunction, at no cost to the Authority, the 30-day test shall restart, at day one, and shall continue until the results are satisfactory with written approval of the engineer.
3. The contractor shall completely check out, calibrate and test all connected hardware and software to ensure that the system performs according to the requirements of this Section and sequences of operation submitted.
4. The contractor shall submit a test report detailing compliance with the requirements of item B and item C above.
5. 30-Day Operational Test
 - a. Testing shall be performed to verify compliance with the requirements of this Section and shall be performed according to the approved testing plan. Correct any malfunctions as they occur, said malfunctions shall include, but not be limited to, equipment failure or failure of the System to comply with the requirements of this Section. After corrections have been made, the 30-day operational test shall restart and shall continue until the results are satisfactory to the engineer for a period of 30 consecutive days.
 - b. Maintain a log during all operational testing. Include a narrative description of corrective measures required and items required or replaced.

D Measurement

The department will measure PIDS, Communications and Security Work as a single unit for each project, acceptably completed.

E Payments

The department will pay for measured quantities at the contract unit price under the following bid item:

ITEM NUMBER	DESCRIPTION	UNIT
SPV.0060.31	PIDS, Communications, and Security Work	EACH

Payment is full compensation for enclosures, conduits, seals, furnishing and installing the PIDS and CCTV system.

52. Wheelchair Lift Enclosure, New and Relocation, Item SPV.0060.32.

A Description

This special provision describes salvaging the existing wheelchair lift storage building, removing existing pad, new pad construction, relocating the existing wheelchair lift enclosure (WCLE) at the east platform and installing an Amtrak-provided wheelchair lift enclosure at the west platform as shown in the plans.

B Materials

B.1 Wheelchair Lift Enclosure

A WCLE for the west platform will be supplied by Amtrak. The east WCLE is to be relocated from the existing location to the new location shown on the plan. Provide new concrete anchors, base flashing and sealant as shown in the plan.

B.2 Aggregate

Provide a crushed aggregate base for the WCLE concrete pad meeting the requirements of standard spec 301.

B.3 Concrete Pad

Provide concrete for the WCLE pads meeting the requirements of standard spec 501.

C Construction

Notify Amtrak at least three working days prior to the removal of the existing lift enclosure. Complete this work immediately following approval of relocation and maintain the wheelchair lift equipment at a temporary designated location for daily use. Coordinate the temporary location with Amtrak.

Before moving the existing WCLE, sufficiently brace the structure to stabilize it during transport. Stability to avoid damage to the WCLE during removal, transport and reinstallation is the responsibility of the contractor. Repair damage to the WCLE as a result of the removal, transport and reinstallation process.

Notify Amtrak at least two weeks before the west WCLE is required for installation.

Remove all concrete, steel, other surface materials, and any debris for the existing location. Grade and seed area after removal. Construct concrete pad as shown in the plan at the new location. Erect enclosure after proper cure.

At the existing WCLE location, restore the brick facing on the adjacent column after removal of the building. Spare bricks for use are currently being stored in the building.

D Measurement

The department will measure Wheelchair Lift Enclosure, New and Relocation as a single unit for each project, acceptably completed.

E Payment

The department will pay for measured quantities at the contract unit price under the following bid item:

ITEM NUMBER	DESCRIPTION	UNIT
SPV.0060.32	Wheelchair Lift Enclosure, New and Relocation	EACH

Payment is full compensation for coordination; removing enclosure, concrete, and steel; disassembling; grading and seeding; providing, pouring, and finishing concrete; disposing of scrap material; installing the relocated and Amtrak-provided wheelchair lift enclosures, and incidentals necessary to complete the contract work.

53. Structural Steel, Item SPV.0085.01.

A Description

This special provision describes furnishing, fabricating, and erecting all structural steel associated with the pedestrian bridge, supporting tower buildings, connecting hallway to existing station and platform canopy as shown on the plans and specified herein. This special provision also includes the delegated design of structural framing connections and pedestrian bridge truss connections. Perform all work for this item according to standard spec 506 and all other applicable requirements of the standard specifications except as modified herein or as shown on the plans.

This work includes, but is not limited to, the following items:

- Steel members of the building framing system and bridge truss including but not limited to the columns, beams, girders, lateral bracing, and roof framing.
- Steel members of the platform canopy system, including but not limited to the columns, cantilever beams, purlins, and closure plates.
- All shop welded stud connectors attached to steel, unless otherwise noted.
- All shop installed and field installed fasteners for steel.
- Any other shop and field fasteners for connection of other items to the above structural steel except for the items otherwise shown or noted on the plans or in the special provisions.
- Any other fabricated steel shown on the plans but not specifically listed above, except those specifically included with another bid item.

B Materials

B.1 General

Furnish steel conforming to the following unless otherwise noted on the plans:

W Shapes and Channels:	ASTM A992, Grade 50
L Shapes and Plates:	ASTM A709, Grade 50
HSS (Pedestrian Bridge Truss):	ASTM A1085 (Fy = 50 ksi)
HSS (Platform Canopy):	ASTM A500, Grade C (Fy = 46 ksi)

Order all plate from the mill that is to be bent during fabrication such that the bend line will be oriented perpendicular to the direction of rolling.

B.1.1 Fracture Control Plan

The AASHTO/AWS Fracture Control Plan (FCP) for Non-redundant Members, (Bridge Welding Code D1.5) shall be followed and shall constitute the Fracture Control Plan for this project, except as modified herein.

All non-redundant fracture critical material, noted (FCM) on the plans shall adhere to all requirements of the Fracture Control Plan.

The first sentence of the second paragraph of Subsection 8.2 of the Guide Specifications is amended as follows:

The Charpy test requirements for weld metal connecting ASTM A992, ASTM A709 and ASTM A1085 steels to be 35 ft-lb (47.5 Nm) at -30 °F (-34.4 °C).

Base metal Charpy V-Notch requirements for fracture critical members are as follows:

MATERIAL: ASTM A992, ASTM A709 and ASTM A1085

GRADES	THICKNESS, INCHES	REQUIREMENTS
50°F Up to 4"	Mechanically Fastened	25 ft-lb @ -30 °F
50°F Up to 2"	Welded	25 ft-lb @ -30 °F
50°F Over 2" to 4" incl.	Welded	30 ft-lb @ -30 °F

F- Designates "Fracture Critical" (Zone number is omitted because this specification exceeds Zone 3)

Conduct the CVN-impact testing "P" plate frequency testing according to AASHTO T-243 (ASTM A673). Conduct Charpy impact tests on each plate at each end. Code the Charpy test pieces with respect to heat/plate number and record that code on the mill-test report of the steel supplier with the test result. If requested by the engineer, submit the broken pieces from each test (three specimens, six halves) to the engineer.

* Reduce acceptability temperature for the CVN value by 15 °F for each increment of 10 ksi above 65 ksi, if the yield strength of the material exceeds 65 ksi. The yield strength is the value given in the certified "Mill Test Report".

** Reduce acceptability temperature for the CVN value by 15 °F for each increment of 10 ksi above 85 ksi, if the yield strength of the material exceeds 85 ksi. The yield strength is the value given in the certified "Mill Test Report".

B.1.2 Bolts and Anchors

Amend standard spec 506.2.5.1 as follows:

Where bolt diameters less than ½ inch or greater than 1½ inches are called for on the plans, use ASTM A449, Type I bolts except where another type of bolt is specifically called for.

Provide high strength bolts that meet FHWA requirements for rotational tests.

Where allowed, for bearing connections only, furnish tension control bolts meeting the requirements of ASTM A3125 Grade F1852 (A325TC).

B.1.3 Submittals

Prepare and submit complete steel shop detail drawings and steel erection drawings.

Prepare and submit to the engineer steel connection design calculations and details. Base the connection design on the ultimate factored loads provided in the plan. Refer to the plan for minimum number of bolts or minimum weld length for connections based on the member size. Connection design calculations must be prepared by an engineer licensed in the State of Wisconsin.

Transmit shop drawings and calculations directly to the engineer for distribution. Do not submit to the department's fabrication library.

Provide the engineer with a schedule for shop drawing development. Submit design calculations a minimum of 14 days prior to submittal of shop drawings. Submit shop drawings for review a minimum of 14 days prior to the start of fabrication.

Prepare and submit to the engineer a detailed pedestrian bridge truss erection plan that includes drawings and written description of all steps including:

- Delivery of the truss section or sections.
- Ground blocking and assembly plan.
- Verification method of distance between tower columns for each of the four truss chords.
- Step by step erection sequence

- Detailed crane and equipment heights, sizes and placements.
- Bolting plan/sequence for the bridge chord end connections.
- Details of temporary bridge support, if used.
- Estimated timeframe for bridge erection, to be used for coordination with the CP Railroad for track outage.

Provide the engineer a minimum of two weeks' written notice to witness the verification of these dimensions

B.2 Galvanizing

B.2.1 General

Hot-dip galvanize the following items, including all appurtenant parts according to ASTM A123 or A153 as applicable.

- All steel for the platform canopy system.
- All bolts, unless noted otherwise on the plans.
- All anchor bolts — from the exposed end to a point 3 inches below the surface of the concrete, unless noted otherwise on the plans
- Any other items designated on the plans to be galvanized

B.2.2 Bolts and Nuts

Tap galvanized nuts oversize according to ASTM A563 and all other applicable ASTM standards. Supplementary Requirement S1, Lubricant and Test for Coated Nuts will apply.

Assemble and ship from a single manufacturer all bolts and nuts. The manufacturer is responsible for all mill tests and other reports and will perform the rotational tests and certification.

Perform rotational capacity tests according to FHWA requirements for all pedestrian bridge truss bolted connections and any other connections designated on the plan as slip-critical.

B.2.3 Repair of Damaged Galvanized Coating

Repair any galvanized areas that are damaged by abrasion and other causes according to ASTM A780, using either the Zinc-Based Solders or the Zinc-Rich Paints type of materials. Follow the requirements of Annexes A1, Repair Using Zinc-Based Alloys, and/or A2, Repair Using Zinc-Rich Paints.

Alternatively, repair damaged areas as specified in standard spec 635.3.4.

B.3 Painting

Structural steel that is concealed behind walls and floors in the towers shall be prime painted according to standard spec 517 of the standard specification.

Clean and paint all exposed structural steel in the towers, all steel members that are part of the pedestrian bridge truss and miscellaneous metals according to standard spec 517 using the Epoxy System, unless otherwise noted.

Paint all metal elements of the towers and bridge according to standard spec 506.3.32.

The color of the epoxy intermediate coat will be white.

Provide a urethane finish coat with white color. Prepare test panels as described under the article "Painting Epoxy System". Include color number for finish coat in shop drawings for structural steel.

Supply the engineer with the product data sheets before any coating is applied. The product data sheets will indicate the mixing and thinning directions, the recommended spray nozzles and pressures, the minimum drying time for shop applied coats, and the recommended procedures for coating galvanized bolts, nuts, and washers.

Blast clean and paint with a 1 mil (minimum dry film thickness) coating of zinc rich primer portions of structural steel which will be embedded in concrete, unless noted otherwise.

Do not perform abrasive blasting within the machinery rooms after the installation of any machinery.

Paint galvanized columns, beams, purlins and closure plates for the canopy system. Provide a wash coat and a tie coat appropriate for painting of galvanized surfaces before painting these members with the same paint system as those on the pedestrian bridge.

B.4 Welding

Perform welding in conformance to the requirements of standard spec 506.3 supplemented by the following:

Perform all welding and non-destructive testing for redundant and non-redundant main members and secondary members of the pedestrian bridge truss in conformance to the current edition of the AASHTO Bridge Welding Specifications, D1.5 and the details shown on the plans. Perform all welding by the electric arc process. Use full penetration welds for all butt and groove welds. The symbols on these plans indicate only the general type of weld required. Submit to the engineer for approval, the proposed weld geometry to be used in fabrication. Include machining or grinding required to maintain 2½ to 1 transitions.

For welding of non-bridge truss members, follow the current edition of AWS D1.1.

If a fillet weld size is not shown on the plans, size the weld according to WisDOT requirements for minimum weld size based on material thickness.

B.5 Shims

Wherever shims are specified on the plans, the nominal, or theoretical, thickness "t" is indicated. Furnish shim pack thicknesses equal to two times the nominal thickness, of the following material thicknesses: t, t/2, t/4, t/8, t/16, etc., unless noted otherwise on the plans.

Use 1/16-inch increments for structural steel connections for parts not having machined surfaces.

B.6 Shop Assembly

In addition to the shop assembly of components required by the standard specifications and as shown or noted on the plans, provide full shop assembly of the pedestrian bridge truss.

Shop assemble the pedestrian bridge truss completely including all main chords, diagonal chords, transverse floor and roof beams, and proposed field splice connections. Shop assembly need not include the floor and roof concrete slab form pans, but an equivalent weight should be applied to the truss so that accurate deflection and length measurements can be taken.

Measure the end-to-end distance of both top and both bottom main chords, with the measurement taken from the outside of the end connection plates. The measurements should be taken with the truss supported as close to the ends as practicable, and in a simply supported condition that allows for full dead weight deflection. Record these measurements and report them in the steel erection drawings. Provide the engineer a minimum of two weeks' written notice to witness the verification of these dimensions.

C Construction

C.1 General

Erect structural steel in a such a manner that required railroad clearances and track control requirements are followed as specified in the section "Railroad Coordination".

C.2 Fabrication

Ensure structural steel is fabricated by an approved fabricator selected from the Approved Products List (APL) for steel bridge primary members or prefabricated steel truss pedestrian bridges. Submit name(s) and location(s) of fabricator(s) to be used to the engineer within 14 days of project award.

C.3 Erection Tolerances

Erect tower framing within such tolerances that the pedestrian bridge may be erected with no more than 1-inch-thick shims at each of the connections between the end gusset plate and the column attachment plate at the ends of the pedestrian bridge truss.

Erect pedestrian bridge truss such that the elevation difference between the ends of the pedestrian truss does not exceed 1/8 inch.

C.4 Shoring

If required by the proposed erection sequence, use adequate blocking, shoring, or struts to support the pedestrian bridge truss before it is bolted into place. Placement of such blocking or shoring must be shown on the proposed erection plan and coordinated with CP Rail.

C.5 Metal Work Set in Concrete

Place and maintain all metal work to be set or embedded in concrete with care to ensure exact alignment elevation. Where grout is shown on the plans, adjust and support the metal parts by means of leveling bolts. Provide an approved self-leveling, high strength non-shrink and non-staining grout. The furnishing and placing of grout will be considered incidental to the work of this bid item and others and no separate payment will be made for it.

D Measurement

The department will measure Structural Steel by the pound, acceptably completed.

E Payment

The department will pay for measured quantities at the contract unit price under the following bid item:

ITEM NUMBER	DESCRIPTION	UNIT
SPV.0085.01	Structural Steel	LB

Payment is full compensation for furnishing, fabricating, transporting and delivering, erecting, and painting all structural steel.

The preparation of shop drawings and preparation of connection design calculations and associated drawings are included in this bid item.

Furnishing and installing shop welded shear connectors to structural steel is included in this bid item and no separate payment will be made for them. These include studs welded to the slab edge bent plates.

Welded Stud Shear Connectors 3/4 x 5-Inch will be paid for separately.

All costs for work associated with coordination of steel erection with the CP Railroad is incidental to the contract.

54. Railing Pipe, Item SPV.0090.01.

A Description

A.1 Summary

1. Section Includes:
 - a. Steel pipe railings.
 - b. Stainless steel pipe railings and handrails.
2. Related Requirements:
 - a. "Metal Pan Stairs" for steel tube railings associated with metal pan stairs.

A.2 Coordination

1. Coordinate selection of shop primers with topcoats to be applied over them. Comply with paint and coating manufacturers' written recommendations to ensure that shop primers and topcoats are compatible with one another.
2. Coordinate installation of anchorages for railings. Furnish setting drawings, templates, and directions for installing anchorages, including sleeves, concrete inserts, anchor bolts, and items with integral anchors, that are to be embedded in concrete or masonry. Deliver such items to Project site in time for installation.

A.3 Action Submittals

1. Product Data:
 - a. Manufacturer's product lines of mechanically connected railings.
 - b. Fasteners.
 - c. Post-installed anchors.
 - d. Handrail brackets.
 - e. Shop primer.
 - f. Intermediate coats and topcoats.
 - g. Nonshrink, nonmetallic grout.
 - h. Anchoring cement.
 - i. Metal finishes.
 - j. Paint products.
2. Shop Drawings: Include plans, elevations, sections, details, and attachments to other work.
3. Samples for Initial Selection: For products involving selection of color, texture, or design, including mechanical finishes.
4. Samples for Verification: For each type of exposed finish required.
 - a. Sections of each distinctly different linear railing member, including handrails, top rails, posts, and balusters, including finish.
 - b. Fittings and brackets.
 - c. Assembled Sample of railing system, made from full-size components, including top rail, post, handrail, and infill. Sample need not be full height.
 - i. Show method of **connecting and finishing** members at intersections.
5. Delegated Design Submittal: For railings, including analysis data signed and sealed by the qualified professional engineer responsible for their preparation.

A.4 Informational Submittals

1. Qualification Data: For delegated design professional engineer
2. Welding certificates.
3. Mill Certificates: Signed by manufacturers of stainless steel products, certifying that products furnished comply with requirements.
4. Paint Compatibility Certificates: From manufacturers of topcoats applied over shop primers, certifying that shop primers are compatible with topcoats.
5. Product Test Reports: For tests on railings performed by a qualified testing agency, according to ASTM E894 and ASTM E935.
6. Research Reports: For post-installed anchors, from ICC-ES or other qualified testing agency acceptable to authorities having jurisdiction.

A.5 Quality Assurance

1. Welding Qualifications: Qualify procedures and personnel according to the following:
 - a. AWS D1.1/D1.1M, "Structural Welding Code - Steel."
 - b. AWS D1.6/D1.6M, "Structural Welding Code - Stainless Steel."

A.6 Delivery, Storage, And Handling

1. Protect mechanical finishes on exposed surfaces of railings from damage by applying a strippable, temporary protective covering before shipping.

A.7 Field Conditions

1. Field Measurements: Verify actual locations of walls and other construction contiguous with railings by field measurements before fabrication.

B Materials

B.1 Performance Requirements

1. Delegated Design: Engage a qualified professional engineer to design railings, including attachment to building construction.
2. Structural Performance: Railings, including attachment to building construction, withstand the effects of gravity loads and the following loads and stresses within limits and under conditions indicated:
 - a. Handrails and Top Rails of Guards:
 - i Uniform load of 70 lbf/ ft. (0.73 kN/m) applied in any direction.
 - ii Concentrated load of 250 lbf (0.89 kN) applied in any direction.
 - iii Uniform and concentrated loads need not be assumed to act concurrently.
 - b. Infill of Guards:
 - i Concentrated load of 70 lbf (0.22 kN) applied horizontally on an area of 1 sq. foot. (0.093 sq. m).
 - ii Infill load and other loads need not be assumed to act concurrently.
3. Thermal Movements: Allow for thermal movements from ambient and surface temperature changes.
 - a. Temperature Change: **120 deg F (67 deg C)**, ambient; **180 deg F (100 deg C)**, material surfaces.

B.2 Metals, General

1. Metal Surfaces, General: Provide materials with smooth surfaces, without seam marks, roller marks, rolled trade names, stains, discolorations, or blemishes.
2. Brackets, Flanges, and Anchors: Cast or formed metal of same type of material and finish as supported rails unless otherwise indicated.
 - a. Provide type of bracket with **flange tapped for concealed anchorage to threaded hanger bolt predrilled hole for exposed bolt anchorage** and that provides 1-1/2-inch (38-mm) clearance from inside face of handrail to finished wall surface.

B.3 Steel Railings And Handrails

1. Source Limitations: Obtain each type of railing from single source from single manufacturer.
2. Tubing: ASTM A500/A500M (cold formed) or ASTM A513/A513M, Type 5.
3. Pipe: ASTM A53/A53M, Type F or Type S, Grade A, Standard Weight (Schedule 40), unless another grade and weight are required by structural loads.
4. Provide galvanized finish for exterior installations and where indicated.
5. Plates, Shapes, and Bars: ASTM A36/A36M.
6. Cast Iron Fittings: Either gray iron, ASTM A48/A48M, or malleable iron, ASTM A47/A47M, unless otherwise indicated.

B.4 Stainless Steel Railings and Handrails

1. Source Limitations: Obtain each type of railing from single source from single manufacturer.
2. Pipe: ASTM A312/A312M, Grade TP 304 Grade TP 316L.

3. Castings: ASTM A743/A743M, Grade CF 8 or CF 20 Grade CF 8M or CF 3M.
4. Plate and Sheet: ASTM A240/A240M or ASTM A666, Type 304 Type 316L.

B.5 Fasteners

1. Fastener Materials:
 - a. Ungalvanized-Steel Railing Components: Plated steel fasteners complying with ASTM F1941/F1941M, Class Fe/Zn 5 for zinc coating.
 - b. Hot-Dip Galvanized Railing Components: Type 304 stainless steel or hot-dip zinc-coated steel fasteners complying with ASTM A153/A153M or ASTM F2329/F2329M for zinc coating.
 - c. Aluminum Railing Components: Type 304 Type 316 stainless steel fasteners.
 - d. Stainless Steel Railing Components: Type 304 Type 316 stainless steel fasteners.
 - e. Finish exposed fasteners to match appearance, including color and texture, of railings.
2. Fasteners for Anchoring Railings to Other Construction: Select fasteners of type, grade, and class required to produce connections suitable for anchoring railings to other types of construction and capable of withstanding design loads.
3. Fasteners for Interconnecting Railing Components:
 - a. Provide concealed fasteners for interconnecting railing components and for attaching them to other work, unless otherwise indicated.
 - b. Provide concealed fasteners for interconnecting railing components and for attaching them to other work, unless exposed fasteners are unavoidable or are the standard fastening method for railings indicated.
 - c. Provide Phillips tamper-resistant square or hex socket flat-head machine screws for exposed fasteners unless otherwise indicated.
4. Post-Installed Anchors: Fastener systems with working capacity greater than or equal to the design load, according to an evaluation report acceptable to authorities having jurisdiction, based on ICC-ES AC193 or ICC-ES AC308.
 - a. Material for Interior Locations: Carbon-steel components zinc-plated to comply with ASTM B633 or ASTM F1941/F1941M, Class Fe/Zn 5, unless otherwise indicated.
 - b. Material for Exterior Locations and Where Stainless Steel Is Indicated: Alloy Group 1 (A1) Group 2 (A4) stainless steel bolts, ASTM F593, and nuts, ASTM F594.

B.6 Miscellaneous Materials

1. Handrail Brackets: Cast iron Cast aluminum, Cast stainless steel, Cast nickel-silver, center of handrail 2-1/2 inches (63.5 mm) 3-1/8 inches (79.4 mm) from face of railing wall.
2. Welding Rods and Bare Electrodes: Select according to AWS specifications for metal alloy welded.
 - a. For **aluminum and stainless steel** railings, provide type and alloy as recommended by producer of metal to be welded and as required for color match, strength, and compatibility in fabricated items.
3. Etching Cleaner for Galvanized Metal: Complying with MPI#25.
4. Galvanizing Repair Paint: High-zinc-dust-content paint, complying with SSPC-Paint 20 and compatible with paints specified to be used over it.
5. Shop Primers: Provide primers that comply with Section "Exterior Painting."
6. Universal Shop Primer: Fast-curing, lead- and chromate-free, universal modified-alkyd primer complying with MPI#79 and compatible with topcoat.
 - a. Use primer containing pigments that make it easily distinguishable from zinc-rich primer.
7. Epoxy Zinc-Rich Primer: Complying with MPI#20 and compatible with topcoat.

8. Shop Primer for Galvanized Steel: Primer formulated for exterior use over zinc-coated metal and compatible with finish paint systems indicated.
9. Intermediate Coats and Topcoats: Provide products that comply with Section "Exterior Painting." Section "Interior Painting."
10. Epoxy Intermediate Coat: Complying with MPI #77 and compatible with primer and topcoat.
11. Polyurethane Topcoat: Complying with MPI #72 and compatible with undercoat.
12. Bituminous Paint: Cold-applied asphalt emulsion, complying with ASTM D1187/D1187M.
13. Nonshrink, Nonmetallic Grout: Factory-packaged, nonstaining, noncorrosive, nongaseous grout, complying with ASTM C1107/C1107M. Provide grout specifically recommended by manufacturer for interior and exterior applications.
14. Anchoring Cement: Factory-packaged, nonshrink, nonstaining, hydraulic-controlled expansion cement formulation for mixing with water at Project site to create pourable anchoring, patching, and grouting compound.
 - a. Water-Resistant Product: **At exterior locations and where indicated on Drawings**, provide formulation that is resistant to erosion from water exposure without needing protection by a sealer or waterproof coating and that is recommended by manufacturer for exterior use.

C Construction

C.1 General

1. Fabricate railings to comply with requirements indicated for design, dimensions, member sizes and spacing, details, finish, and anchorage, but not less than that required to support structural loads.
2. Shop assemblies railings to greatest extent possible to minimize field splicing and assembly. Disassemble units only as necessary for shipping and handling limitations.
 - a. Clearly mark units for reassembly and coordinated installation.
 - b. Use connections that maintain structural value of joined pieces.
3. Cut, drill, and punch metals cleanly and accurately.
 - a. Remove burrs and ease edges to a radius of approximately 1/32 inch (1 mm) unless otherwise indicated.
 - b. Remove sharp or rough areas on exposed surfaces.
4. Form work true to line and level with accurate angles and surfaces.
5. Fabricate connections that are exposed to weather in a manner that excludes water.
 - a. Provide weep holes where water may accumulate.
 - b. Locate weep holes in inconspicuous locations.
6. Cut, reinforce, drill, and tap as indicated to receive finish hardware, screws, and similar items.
7. Connections: Fabricate railings with welded or nonwelded connections unless otherwise indicated.
8. Gates: Form gates from steel tube of same size and shape as top rails, with infill to match guards. Provide with cam-type, self-closing spring hinges for fastening to wall and overlapping stop with rubber bumper to prevent gate from opening in direction opposite egress.
9. Welded Connections: Cope components at connections to provide close fit, or use fittings designed for this purpose. Weld all around at connections, including at fittings.
 - a. Use materials and methods that minimize distortion and develop strength and corrosion resistance of base metals.
 - b. Obtain fusion without undercut or overlap.

- c. Remove flux immediately.
 - d. At exposed connections, finish exposed welds to comply with NOMMA's "Voluntary Joint Finish Standards" for Finish #1 welds; ornamental quality with no evidence of a welded joint Finish #2 welds; good appearance, completely sanded joint, some undercutting and pinholes okay Finish #3 welds; utilitarian appearance not subject to view, partially dressed weld with spatter removed.
10. Welded Connections for Aluminum Pipe: Fabricate railings to interconnect members with concealed internal welds that eliminate surface grinding, using manufacturer's standard system of sleeve and socket fittings.
 11. Nonwelded Connections: Connect members with concealed mechanical fasteners and fittings. Fabricate members and fittings to produce flush, smooth, rigid, hairline joints.
 - a. Fabricate splice joints for field connection, using an epoxy structural adhesive, if this is manufacturer's standard splicing method.
 12. Form changes in direction as follows:
 - a. As detailed.
 - b. By bending or by inserting prefabricated elbow fittings.
 - c. By flush bends or by inserting prefabricated flush-elbow fittings.
 - d. By radius bends of radius indicated or by inserting prefabricated elbow fittings of radius indicated.
 - e. By bending to smallest radius that will not result in distortion of railing member.
 13. Bend members in jigs to produce uniform curvature for each configuration required. Maintain cross section of member throughout entire bend without buckling, twisting, cracking, or otherwise deforming exposed surfaces of components.
 14. Close exposed ends of hollow railing members with prefabricated cap and end fittings of same metal and finish as railings.
 15. Provide wall returns at ends of wall-mounted handrails unless otherwise indicated. Close ends of returns unless clearance between end of rail and wall is 1/4 inch (6 mm) or less.
 16. Brackets, Flanges, Fittings, and Anchors: Provide wall brackets, flanges, miscellaneous fittings, and anchors to interconnect railing members to other work unless otherwise indicated.
 - a. At brackets and fittings fastened to plaster or gypsum board partitions, provide crush-resistant fillers or other means to transfer loads through wall finishes to structural supports and prevent bracket or fitting rotation and crushing of substrate.
 17. Provide inserts and other anchorage devices for connecting railings to concrete or masonry work.
 - a. Fabricate anchorage devices capable of withstanding loads imposed by railings.
 - b. Coordinate anchorage devices with supporting structure.
 18. For railing posts set in concrete, provide stainless steel sleeves not less than 6 inches (150 mm) long with inside dimensions not less than 1/2 inch (13 mm) greater than outside dimensions of post, with metal plate forming bottom closure.
 19. For removable railing posts, fabricate slip-fit sockets from stainless steel tube or pipe whose ID is sized for a close fit with posts; limit movement of post without lateral load, measured at top, to not more than one-fortieth of post height.
 - a. Provide socket covers designed and fabricated to resist being dislodged.
 - b. Provide chain with eye, snap hook, and staple across gaps formed by removable railing sections at locations indicated. Fabricate from same metal as railings.

C.2 Steel And Iron Finishes

1. Galvanized Railings:
 - a. Hot-dip galvanize exterior indicated steel railings, including hardware, after fabrication.
 - b. Comply with ASTM A123/A123M for hot-dip galvanized railings.
 - c. Comply with ASTM A153/A153M for hot-dip galvanized hardware.
 - d. Do not quench or apply post-galvanizing treatments that might interfere with paint adhesion.
2. Preparation for Shop Priming: Prepare uncoated ferrous-metal surfaces to comply with SSPC-SP 6/NACE No. 3. SSPC-SP 3. requirements indicated below:
 - a. Exterior Railings: SSPC-SP 6/NACE No. 3.
 - b. Railings Indicated To Receive Zinc-Rich Primer: SSPC-SP 6/NACE No. 3.
 - c. Railings Indicated To Receive Primers : SSPC-SP 6/NACE No. 3.
 - d. Other Railings: SSPC-SP 3.
3. Primer Application: Apply shop primer to prepared surfaces of railings unless otherwise indicated. Comply with requirements in SSPC-PA 1 for shop painting. Primer need not be applied to surfaces to be embedded in concrete or masonry.
 - a. Shop prime uncoated railings with universal shop primer primers specified in Section "Exterior Painting" and Section "Interior Painting" unless zinc-rich primer is are indicated.
4. Shop-Painted Finish: Comply with Section "Exterior Painting."
 - a. Color: As indicated by manufacturer's designations Match Architect's sample As selected by Architect from manufacturer's full range.
5. High-Performance Coating: Apply epoxy intermediate and polyurethane topcoats to prime-coated surfaces. Comply with coating manufacturer's written instructions and with requirements in SSPC-PA 1 for shop painting. Apply at spreading rates recommended by coating manufacturer.
 - a. Color: As indicated by manufacturer's designations Match Architect's sample As selected by Architect from manufacturer's full range.

C.3 Stainless Steel Finishes

1. Surface Preparation: Remove tool and die marks and stretch lines, or blend into finish.
2. Polished Finishes: Grind and polish surfaces to produce uniform finish, free of cross scratches.
 - a. Run grain with long dimension of each piece.
 - b. When polishing is completed, passivate and rinse surfaces.
 - c. Remove embedded foreign matter and leave surfaces chemically clean.
3. Stainless Steel Pipe and Tubing Finishes:
 - a. 180-Grit Polished Finish: Uniform, directionally textured finish.
 - b. Polished and Buffed Finish: 320-grit finish followed by buffing **to a high luster finish to a mirror-like finish to match Architect's sample.**
4. Stainless Steel Sheet and Plate Finishes:
 - a. Directional Satin Finish: ASTM A480/A480, No. 4.

C.4 Examination

1. Examine plaster and gypsum board assemblies, where reinforced to receive anchors, to verify that locations of concealed reinforcements are clearly marked for Installer. Locate reinforcements and mark locations if not already done.

C.5 Installation, General

1. Perform cutting, drilling, and fitting required for installing railings.
 - a. Fit exposed connections together to form tight, hairline joints.
 - b. Install railings level, plumb, square, true to line; without distortion, warp, or rack.
 - c. Set railings accurately in location, alignment, and elevation; measured from established lines and levels.
 - d. Do not weld, cut, or abrade surfaces of railing components that are coated or finished after fabrication and that are intended for field connection by mechanical or other means without further cutting or fitting.
 - e. Set posts plumb within a tolerance of 1/16 inch in 3 feet (2 mm in 1 m).
 - f. Align rails so variations from level for horizontal members and variations from parallel with rake of steps and ramps for sloping members do not exceed 1/4 inch in 12 feet (6 mm in 3.5 m).
2. Control of Corrosion: Prevent galvanic action and other forms of corrosion by insulating metals and other materials from direct contact with incompatible materials.
 - a. Coat concealed surfaces of aluminum that will be in contact with grout, concrete, masonry, wood, or dissimilar metals, with a heavy coat of bituminous paint.
3. Adjust railings before anchoring to ensure matching alignment at abutting joints.
4. Fastening to In-Place Construction: Use anchorage devices and fasteners where necessary for securing railings and for properly transferring loads to in-place construction.

C.6 Railing Connections

1. Nonwelded Connections: Use mechanical or adhesive joints for permanently connecting railing components. Use wood blocks and padding to prevent damage to railing members and fittings. Seal recessed holes of exposed locking screws, using plastic cement filler colored to match finish of railings.
2. Welded Connections: Use fully welded joints for permanently connecting railing components. Comply with requirements for welded connections in "Fabrication" Article, whether welding is performed in the shop or in the field.
3. Expansion Joints: Install expansion joints at locations indicated but not farther apart than required to accommodate thermal movement. Provide slip-joint internal sleeve, extending 2 inches (50 mm) beyond joint on either side; fasten internal sleeve securely to one side; and locate joint within 6 inches (150 mm) of post.

C.7 Anchoring Posts

1. Use stainless steel pipe sleeves preset and anchored into concrete for installing posts. After posts are inserted into sleeves, fill annular space between post and sleeve with non-shrink, non-metallic grout or anchoring cement, mixed and placed to comply with anchoring material manufacturer's written instructions.
2. Form or core-drill holes not less than 5 inches (125 mm) deep and 3/4 inch (20 mm) larger than OD of post for installing posts in concrete. Clean holes of loose material, insert posts, and fill annular space between post and concrete with non-shrink, non-metallic grout or anchoring cement, mixed and placed to comply with anchoring material manufacturer's written instructions.
3. Cover anchorage joint with flange of same metal as post, welded to post after placing anchoring material attached to post with setscrews.
4. Leave anchorage joint exposed with 1/8-inch (3-mm) buildup, sloped away from post anchoring material flush with adjacent surface.

5. Anchor posts to metal surfaces with flanges, angle type, or floor type, as required by conditions, connected to posts and to metal supporting members as follows:
 - a. For steel railings, weld flanges to post and bolt to metal supporting surfaces.
 - b. For aluminum railings, attach posts as indicated, using fittings designed and engineered for this purpose.
 - c. For stainless steel railings, weld flanges to post and bolt to supporting surfaces.
6. Install removable railing sections, where indicated, in slip-fit stainless steel sockets cast in concrete.

C.8 Attaching Railings

1. Anchor railing ends to concrete and masonry with sleeves concealed within flanges connected to brackets on underside of rails connected to railing ends and anchored to wall construction with anchors and bolts.
2. Anchor railing ends to metal surfaces with flanges bolted to metal surfaces and welded to railing ends or connected to railing ends, using nonwelded connections.
3. Attach handrails to walls with wall brackets, except where end flanges are used. Provide brackets with **1-1/2-inch (38-mm)** clearance from inside face of handrail and finished wall surface.
 - a. Use type of bracket with flange tapped for concealed anchorage to threaded hanger bolt predrilled hole for exposed bolt anchorage.
 - b. Locate brackets as indicated or, if not indicated, at spacing required to support structural loads.
4. Secure wall brackets and railing end flanges to building construction as follows:
 - a. For concrete and solid masonry anchorage, use drilled-in expansion shields and hanger or lag bolts.
 - b. For hollow masonry anchorage, use toggle bolts.
 - c. For wood stud partitions, use hanger or lag bolts set into studs or wood backing between studs. Coordinate with carpentry work to locate backing members.
 - d. For steel-framed partitions, use hanger or lag bolts set into fire-retardant-treated wood backing between studs. Coordinate with stud installation to locate backing members.
 - e. For steel-framed partitions, fasten brackets directly to steel framing or concealed steel reinforcements, using self-tapping screws of size and type required to support structural loads.
 - f. For steel-framed partitions, use toggle bolts installed through flanges of steel framing or through concealed steel reinforcements.
5. Install railing gates level, plumb, and secure for full opening without interference.
 - a. Attach hardware using tamper-resistant or concealed means.
 - b. Adjust hardware for smooth operation.

C.9 Repair

1. Touchup Painting:
 - a. Immediately after erection, clean field welds, bolted connections, and abraded areas of shop paint, and paint exposed areas with the same material used for shop painting to comply with SSPC-PA 1 for touching up shop-painted surfaces.
 - i. Apply by brush or spray to provide a minimum 2.0-mil (0.05-mm) dry film thickness.

C.10 Cleaning

1. Clean stainless steel by washing thoroughly with clean water and soap and rinsing with clean water.

- Galvanized Surfaces: Clean field welds, bolted connections, and abraded areas, and repair galvanizing to comply with ASTM A780/A780M.

C.11 Protection

- Protect finishes of railings from damage during construction period with temporary protective coverings approved by railing manufacturer. Remove protective coverings at time of Substantial Completion.
- Restore finishes damaged during installation and construction period, so no evidence remains of correction work. Return items that cannot be refinished in the field to the shop; make required alterations and refinish entire unit or provide new units.

D Measurement

The department will measure Railing Pipe by the linear foot, acceptably completed.

E Payment

The department will pay for measured quantities at the contract unit price under the following bid item:

ITEM NUMBER	DESCRIPTION	UNIT
SPV.0090.01	Railing Pipe	LF

Payment is full compensation for furnishing and installation of all railing in the project.

55. Drilled Shaft Foundations 24-inch, Item SPV.0090.02.

A Description

This special provision describes installing drilled shafts for the tower walkway and canopy foundations as shown on the plans.

A.1 Qualifications of the Contractor

The contractor performing the work described in these special provisions must have successfully completed drilled shaft projects within the last 5 years. The contractor must submit a list outlining their experience on at least five projects where they have successfully completed drilled shaft construction, including one project completed within the last 5 years. The project experience must include at least one project completed in soil and groundwater conditions similar to those anticipated for this project. The project experience must include advancing the drilled shafts to a depth of at least 30 feet below the original ground surface. At least one project must show evidence of permanence with a 5-year minimum age. The project experience documentation for each project must include a brief project description; detail the size of the shafts, construction methods used during installation, methods used for wall stabilization, local soil conditions, actual construction time and contact information consisting of an individual's name and current phone number. Contacts must be capable of verifying project participation.

The contractor must submit staff experience records of the engineer, drill operators, and onsite supervisors and crew chiefs who will be assigned to the project. The staff records must contain a summary of each individual's experience and it must be complete enough for the engineer to determine whether each individual has satisfied the following qualifications.

The contractor must assign an engineer to supervise the work who has at least eight years of drilled shaft experience and who has completed at least one drilled shaft project. The assigned engineer's project experience must include at least one project completed in soil and groundwater conditions similar to those anticipated for this project. The contractor may not use consultants or manufacturer's representatives in order to meet the requirements of this section. Drill operators, and onsite supervisors and crew chiefs must have a minimum of one-year experience installing drilled shafts with the contractor's organization.

Submit the contractor's qualifications and staff experience records at the preconstruction meeting or 14 calendar days prior to the start of drilled shaft construction, whichever date is earlier. The engineer will accept or reject the contractor's qualifications and staff experience records within 14 calendar days after

receipt of the submission. Do not start work on any drilled shaft piers until acceptance of the contractor's qualifications, staff experience, and drilled shaft installation plan is given by the engineer. The engineer may suspend the drilled shaft work if the contractor substitutes unqualified personnel for accepted personnel during construction. If work is suspended due to the substitution of unqualified personnel, the adjustment in contract time resulting from the suspension of work will not be allowed.

B Materials

B.1 General

Concrete, drilling fluid, reinforcement and formwork shall conform to the requirements of QMP Drilled Shafts and the standard specifications.

In the event that the provisions of other specification clauses cause ambiguity or conflict with the requirement of these special provisions, these special provisions shall take precedence unless otherwise accepted by the engineer.

B.2 Equipment

Equipment used for excavation, drilling, and cleaning operations shall have adequate capacity including power, torque, and down thrust to excavate a hole to a depth equal to the maximum depth of the drilled shafts shown in the plans plus 15 feet, or plus 20 percent of their maximum depth, whichever is greater. Anticipate and make available at the job site all equipment necessary and essential to penetrate soft and hard soils, as well as obstructions, during the construction of the drilled shafts.

Where hard soils, or other material including natural or man-made obstructions are encountered and cannot be drilled using conventional earth or rock augers, drilling buckets, and/or over reaming tools; provide drilling equipment including, but not limited to rock core barrels, rock tools, down the hole hammers, chisels, air tools, or any other equipment necessary to construct the drilled shaft excavation to the depth and size as shown on the plans.

When applicable, or required by the engineer, provide equipment that produces a stable slurry suspension, mechanical agitation, and a pipeline or other safe methods of transporting the slurry to the drilled shaft.

B.3 Casing

B.3.1 Temporary Casing

Temporary casing shall be steel; rigid, smooth, clean, watertight, and of ample strength to withstand both handling and installation stresses and the pressure of both concrete and the surrounding earth materials. Temporary casing must be of sufficient length to provide temporary casing the full length of excavation for all drilled shafts. Segmented casing, if used, must be segmented using flush bolted, casing joints. Telescoping casing is not permitted. The diameter of casing shall not be less than the specified size of the drilled shaft. All casing diameters shown on the plans refer to outside diameter (O.D) dimensions.

B.4 Left-In-Place Casing

Left-in-place casing shall be steel that minimally conforms to ASTM A36. Substitution of steel material with properties meeting or exceeding ASTM A36 may be used if approved by the engineer. Supply casing of the minimum length to achieve the length shown on the plans plus an additional 2 feet minimum embedment into the shaft concrete. Left-in-place casing shall be rigid, smooth, clean, watertight, and of ample strength to withstand both handling and installation stresses and the pressure of both concrete and the surrounding earth materials. The outside diameter of casing shall not be less than the specified size of the drilled shaft. All casing diameters shown on the plans refer to O.D. dimensions.

B.5 Reinforcing Steel and Spacers

Deformed reinforcing bars shall comply with the size, dimension, spacing, and details shown on the plans. In addition, they shall conform to AASHTO M31, Grade 60, and all the pertinent requirements of standard spec 505. Non-corrosive wheel type spacers and boots shall be used to properly position the reinforcing steel. All reinforcing steel shall be 100% wire tied between the vertical reinforcement and ties.

C Construction

C.1 Drilled Shaft Installation Plan

C.1.1 General

Prepare a Drilled Shaft Installation Plan and submit it at the preconstruction meeting or at least 14 calendar days prior to beginning drilled shaft foundation construction, whichever date is earlier. Submit the Drilled Shaft Installation Plan to the engineer for review. The engineer will accept the plan as submitted or return the plan with requested revisions. Do not start any drilled shaft installation until the engineer accepts the Drilled Shaft Installation Plan. Acceptance of the installation plan does not relieve the contractor of responsibility for successful completion of the drilled shafts.

C.1.2 Submittals

The submitted Drilled Shaft Installation Plan shall include the following:

- a. **Job Site Visit.** The contractor shall acknowledge that the job site was visited to verify the site conditions with regard to entrance, access, overhead lines, subsurface features, clearing and grubbing, permitting, and collecting all information necessary to plan and execute the installation of the drilled shafts.
- b. **Plan to Protect Existing Structures.** Outline the steps to be taken during drilled shaft installation to protect adjacent or nearby structures.
- c. **Details of Environmental Control Procedures.** Provide plan to prevent loss of slurry or concrete into waterways, project areas, or protected areas. Detail method to ensure the compliance with state and federal environmental regulations during drilled shaft construction.
- d. **List of Proposed Equipment.** Include details of proposed templates; number and sizes of cranes; number and sizes of oscillators; number and sizes of drills, include rotary torque, crowd force drills, and maximum drilling depth; diameter, length, and reach of augers, bailing buckets, guide walls, templates, and roller bits; cleaning equipment including cleaning buckets, submersible pumps, or air-lifted pumps; size of de-sanding equipment and slurry pumps; soil/rock-coring sampling equipment; inspecting drilled shaft apparatus; length and diameter of tremie or size of concrete pumps; size, length, and thickness of casings; over reaming equipment; and all relevant equipment necessary to complete the drilled shaft installation. Acceptance of the installation plan by the department does not relieve the contractor responsibility to provide other equipment, if necessary, to achieve satisfactory shaft installations meeting the requirements of this special provision.
- e. **Details of Sequence of Drilled Shaft Installation and Time for Construction Operations.** Include a layout of the drilled shaft installation sequence and setting template(s). Include time for installing casings, sealing casing, excavation and/or drilling time, drilled shaft cleaning, rock coring, drilled shaft inspection, concrete placement. The contractor should consider the effect of construction operations of one drilled shaft onto the adjacent drilled shaft(s) and avoid construction conflicts that will affect the quality or integrity of the completed work. Indicate when and what construction sequence modifications shall be performed under atypical situations, i.e., weekend or holiday shutdowns, or unanticipated shutdowns due to equipment issues.
- f. **Proposed Drilled Shaft Installation Procedure(s).** Provide details of the proposed shaft installation procedures, including coring or drilling boulders, rock or obstructions or steep sloping surfaces, when required, and meeting the minimum installation requirements set forth in subsection C.3. Method for identification of the competent or bearing material before finalizing the excavation. Method for monitoring verticality of the drilled shaft walls during excavation, and details of proposed corrective measures to be implemented for shafts out of tolerance. Details of the means and methods of preventing displacement of the casing and/or drilled shaft during installation.
- g. **Details of Slurry Operations.** This is required if slurry is used to stabilize the bottom of the excavation within the casing. Include slurry type, methods to mix, circulation, desanding, and test the slurry to comply with these special provisions.

- h. Inspection and Cleaning. Methods to clean and inspect the drilled shaft excavation prior to reinforcement placement.
- i. Details of Steel Reinforcement Placement During Construction. Include methods to ensure cage centering and cover; cage integrity while lifted during placement, number of cranes, number of lift points, and number of spreader bars; number and location of bottom and side spacers; cage support; and tie downs during concrete placement.
- j. Concrete Placement Plan. The purpose of the Concrete Placement Plan is to ensure that sufficient concrete is at the job site or in transit to the job site so that the entire pour can be done without delay. Include location of the concrete plant, number of trucks, estimated delivery times, estimated time between trucks, and number of trucks at the site before placement begins. Indicate the use of tremie or concrete pump lines and details of the seal to be used at the bottom end of the tremie or concrete pump line. Breakdowns of concrete plants, trucks, or traffic problems shall be considered under this Concrete Placement Plan. Contractor must be aware of batch, travel, and concrete placement times. Include an estimate of the concrete placement and over pouring time per drilled shaft. When applicable, detail excavation to grade and finishing of the drilled shafts.
- k. Casing Removal. Include the details and means by which the contractor intends to remove temporary casings and provide information about staged temporary casing removal when applicable.
- l. Setting Left-In-Place Casings. Include details and means of setting the left-in-place casing where shown in the plans. Include details on method of removing or otherwise avoiding the over pour shaft concrete displaced above the bottom of the socket from being permanently trapped inside the left-in-place casing.
- m. Methods of Handling and Disposal of Spoil Excavation, Waste Slurry, Waste Concrete, and Drilled Shaft Cutoffs. Present sufficient details to the engineer to evaluate the adequacy and compliance of the contractor's methods of disposal with the standard specifications, including all related environmental permits and local regulations.
- n. Other Information requested on the plans or by the engineer.
- o. Reinforcing Steel Assembly and Installation Plan. For shafts with a 6'-0" minimum nominal diameter and 60'-0" minimum length, prepare and submit the reinforcing steel assembly and installation plan. Reinforcing steel shop drawings, details of reinforcement placement, including bracing, centering, and lifting methods, and the method to assure the reinforcing cage position is maintained during construction, including use of bar boots and/or rebar cage base plates, and including placement of rock backfill below the bottom of shaft elevation shall comply with the pertinent requirements of the specifications.

The reinforcing steel assembly and installation plan shall include:

- i Procedure and sequence of steel reinforcing bar cage assembly.
- ii The tie pattern, tie types, and tie wire gauges for all ties on permanent reinforcing and temporary bracing.
- iii Number and location of primary handling steel reinforcing bars used during lifting operations.
- iv Type and location of all steel reinforcing bar splices.
- v Details and orientation of all internal cross-bracing, including a description of connections to the steel reinforcing bar cage.
- vi Description of how temporary bracing is to be removed.
- vii Location of support points during transportation.
- viii Cage weight and location of the center of gravity.
- ix Number and location of pick points used for lifting for installation, and for transport (if assembled off-site).

- x Crane charts and a description and/or catalog cuts for all spreaders, blocks, sheaves, and chockers used to equalize or control lifting loads.
- xi The sequence and minimum inclination angle at which intermediate belly rigging lines (if used) are released.
- xii Pick point loads at 0, 45, 60, and 90 degrees and at all intermediate stages of inclination where rigging lines are engaged or slackened.
- xiii Methods and temporary supports required for cage splicing.
- xiv For picks involving multiple cranes, the relative locations of the boom tips at various stages of lifting, along with corresponding net horizontal forces imposed on each crane.

C.1.3 Acceptance

The department will evaluate the Drilled Shaft Installation Plan for conformance with the requirements of these special provisions. Within 14 calendar days after receipt of the Drilled Shaft Installation Plan, the engineer will notify the contractor of the acceptance of the plan, or of additional information and/or changes required. Any unacceptable part of the Drilled Shaft Installation Plan will require resubmission. The contractor must resubmit the Drilled Shaft Installation Plan for evaluation and review with the necessary changes or additional information provided. The engineer will provide a written notice of acceptance or rejection of contractor's resubmitted Drilled Shaft Installation Plan within 14 calendar days after its receipt. The accepted contractor's Drilled Shaft Installation Plan will be subjected to trial and satisfactory performance in the field, and the engineer will grant final acceptance of the plan after its satisfactory field performance.

After assessment or reassessment of the Drilled Shaft Installation Plan has been made and the engineer has granted its acceptance, do not make any changes to the plan without written consent of the engineer.

C.2 Drilled Shaft Installation

C.2.1 General

Construct drilled shaft foundations conforming to the accepted Drilled Shaft Installation Plan. The resulting installation plan shall include length of permanent casing, grouting or other methods to stop loss of drilling fluid or concrete or collapse of soil, details of the constituent materials of any drilling fluid used for stabilization, the method of inspection, details of the concrete design mix, concreting method, the minimum time between the completion of one shaft and the commencement of the next, and the pattern of construction.

Ensure that damage does not occur to the completed shafts through their working methods. Submit to the engineer a drilled shaft installation sequence. The proposed sequence and timing of shaft installation shall be such that the installation work shall not cause any damage to adjacent shafts. The shaft installation shall not commence until acceptance of the engineer has been obtained.

C.2.2 Subsurface Conditions

Neither the department nor the engineer will accept responsibility for any opinions or conclusions given in any factual or interpretative site investigation reports. Report immediately to the engineer any circumstance, which indicates that in the contractor's opinion the ground conditions differ from those reported in or which could have been inferred from the ground investigation reports or test results.

C.2.3 Sequence of Shaft Installation

The engineer reserves the right and the contractor shall recognize such right to direct the installation of working shafts in any sequence the engineer deems necessary for the satisfactory completion of the work.

C.2.4 Templates

The contractor may elect the use of templates, which will be used in the installations of the shafts to meet the tolerances specified in these special provisions.

C.2.5 Temporary Working Surface

The contractor should use a temporary working surface to provide a level surface at the top of shafts for drilling where needed.

C.2.5.1 Forcible Correction

Where shafts have not been positioned within the specified limits no method of forcible correction will be permitted.

C.2.6 Records

Keep a record of all shafts installed. Give a copy of the record of the work done each day to the engineer within 24 hours of that day's work being completed. The engineer will accept the record form before drilled shaft works commence. Incorporate any comment by the engineer into the record form. Note all unexpected drilling or installation conditions in the records.

C.2.7 Drilled Shaft Installation

C.2.7.1 General

The dry method or wet method can be used as necessary to produce a sound and durable structure foundation free of defects. When a particular installation method is required in the special provisions, only that method of construction shall be used. If no particular method is specified for use, select and use one of the methods of construction cited above as determined by the site conditions and needed to properly accomplish the work. Submit to the engineer for acceptance the selected method of construction in the Drilled Shaft Installation Plan described in these special provisions.

Where soil and groundwater conditions vary along the site, a single method of construction may be not appropriated for the entire job site; and one, two, or a combination of methods may be used.

Consider using temporary casing at all sites where the use of the slurry installation method is not possible and where the use of casing, other than surface casing, is necessary to keep the shaft excavation stable.

In other cases, where drilling through materials having a tendency to squeeze or cave and caving or squeezing cannot be controlled by the drilling fluid, advance permanent casing through the unstable condition(s) and to the projected depth by twisting, drilling, or vibrating. Obtain prior approval from the engineer for vibrating the casing. After the casing is in place, excavate inside the casing to the projected shaft tip elevation using the dry or wet excavation techniques described below. Clean the bottom of the excavation; test the drilling fluid for compliance with these special provisions, if applicable. Before withdrawing the temporary casing, ensure that the level of fresh concrete inside the casing is at such level that the pressure of its hydrostatic head displaces up and out the fluid trapped between the annular space between the casing and the drilled shaft wall. The engineer may require the contractor to overream the outside diameter of the drilled shaft before placing the permanent casing.

C.2.7.2 Dry Method

The dry method of drilled shaft installation shall be considered only in conjunction with permanent casing.

The dry installation method consists of drilling the shaft excavation, removing, and cleaning all accumulated loose material from within the cased excavation, placing the reinforcement cage, and pouring the concrete in the dry excavation. This method may be used below the water table when 1-1/2 inches or less of seepage accumulates at the bottom of the drilled shaft excavation over a 1-hour period, and when the sides and bottom of the shaft remain stable without detrimental caving, sloughing, or swelling for a minimum of a 4-hour period. Seepage is defined as the cumulative inflow of groundwater through the voids of the saturated soil mass into the drilled shaft excavation. Measurement of the seepage quantity (depth at bottom of hole) shall be done without any seepage water being pumped out of the shaft excavation by a pump or similar device. Should seepage water accumulate and be present inside the excavation to a depth of greater than 3 inches at any time prior to concreting, then free fall concrete cannot be placed; instead, employ the tremie or pump procedures to direct the concrete into the excavation.

C.2.7.3 Wet Method

Use the wet installation method, or the casing installation method, for drilled shafts that do not meet the requirements of the dry installation. The wet installation method shall be considered also at all sites where it is impractical to provide a dry excavation for drilling and placing concrete in the drilled shaft. Use the wet method for excavations above or below the water table and with or without casings, depending upon soil type and groundwater conditions. When using the wet method below the groundwater table, all drilled shaft operations shall be accomplished while maintaining a positive head of fluid above the water table.

A temporary surface casing may be provided to aid in positioning and aligning the drilled shaft and to prevent sloughing of the superficial material.

When using the wet installation method, follow the following steps:

- a. Drill the excavation and keep the drilled shaft always filled with fluid such as water, natural slurry, or slurry.
- b. During excavation, test the properties of the fluid for compliance with these specifications, clean or de-sand the fluid as applicable.
- c. Clean the bottom of the excavation with a bailing bucket, an airlift, a submersible pump, or other devices after the excavation is completed.
- d. Just before lowering the reinforcing cage, test the fluid for conformance with the specifications.
- e. Pour the concrete with a tremie pipe or a pump line extending to bottom of the excavated shaft to displace the fluid up and out of the shaft.

C.2.8 Excavations

C.2.8.1 General

Excavations required for the drilled shafts shall be performed through whatever materials encountered, of the dimensions and to the elevations shown in the plans, or as directed by the engineer. The excavation and installation method shall be suitable for the intended results and materials encountered. Blasting is not permitted.

Maintain a construction log during the drilled shaft excavation. Include on the construction log information such as ground elevation, groundwater elevation, sequence number, method of installation, machines and tools employed, drilling fluids employed, drilling times, excavated materials and their particular elevations, soil/rock-cores samples and their particular elevations, rock sockets and their elevation, bells plus their size and elevations, and all other information relevant to the excavation process that will assist the engineer in evaluating the foundation. Information shall also include proposed methods for disposal of excavated material and slurry conforming to state and local environmental regulations, codes and ordinances, the standard specifications, or as directed by the engineer.

Sidewall overreaming shall be required when the sidewall of a drilled shaft as determined by the engineer have either softened due to, but not limited to, excavation methods, swelled due to delays in concreting, or degradation because of slurry cake buildup. The engineer shall direct the thickness and extent of sidewall overreaming. However, overreaming thickness shall be 1/2-inch minimum and 3 inches maximum. The contractor shall bear all the costs associated with sidewall overreaming and concrete required to fill the additional overreaming volume of excavation.

C.2.8.2 Templates

Templates will be required for the installation of drilled shaft foundations if the contractor cannot demonstrate and consistently achieve during construction, proper position and alignment of the installed drilled shaft foundations within specified tolerances without templates.

C.2.8.3 Protection of Existing Structures

Take all reasonable precautions to prevent damage to existing structures and utilities. These measures shall include, but are not limited to, vibration monitoring or subsidence control during installation of casings, sheets, or drilling operations.

C.2.8.4 Overburden Drilled Shaft Excavation

Provide the necessary equipment to remove and dispose of all materials encountered in forming the drilled shaft excavation to the dimension and elevation as shown on the plans, or as directed by the engineer. Contractor's equipment may include, but are not limited to, augers and rotary drills. Unless otherwise shown on the plans, the drilled shaft excavations in overburden materials shall be vertical bored holes extending from the ground surface down to design tip elevation or the competent soil material, whichever is greater, where competent soil material is defined as the soil that will provide support and satisfactory performance to the structure.

In case of groundwater or severe seepage condition, with the flow of water very difficult to control, take appropriate measures including excavation with drilling fluid or excavation through a casing as indicated in the Drilled Shaft Installation Plan.

C.2.8.5 Obstructions

Remove obstructions at drilled shaft locations. Obstructions may include natural and man-made materials, such as old reinforced steel concrete foundations or natural materials such as boulders. Boulders are defined as stones greater than 12 inches. Special tools and/or procedures shall be used when the contractor cannot advance the hole more than 1 foot in 30 minutes using conventional rock augers fitted with teeth, drilling buckets, or underreaming tools operating at maximum power, torque, and down thrust. Special procedures/tools may be required but are not limited to chisels, boulder breakers, core barrels, air hammer tools, and hand excavation. Other methods for obstruction removal such as temporary casing or hole diameter increase can be employed to aid in the removal. Blasting shall not be permitted.

C.2.8.6 Lost Tools

Drilling tools that are lost in the excavation shall not be considered obstructions and shall be promptly removed. All costs due to removal of lost tools shall be borne by the contractor including costs associated with hole degradation during removal operations or time while the hole remains open.

C.2.8.7 Inspections and Cleanliness of Excavation

Provide the details of drilled shaft inspection and cleanliness within the Drilled Shaft Installation Plan, required by subsection C.1.2 of this specification. Provide equipment and tools for checking the dimensions and alignment of each drilled shaft excavation, and coordinate schedules for inspection of the excavation with the engineer. Determine dimensions, alignment, and final depth of the drilled shafts after final cleaning. When applicable, provide safe access and egress to the engineer for inspection of the walls and bottom of the drilled shaft excavation prior to placement of the rebar cage and concrete. After the drilled shaft excavation has been prepared for inspection, notify the engineer. The cleanliness and the bearing surface of the drilled shafts will be evaluated and accepted by the engineer. Unless the engineer specifies otherwise, the contractor's cleaning operation shall be considered sufficient when no more than 50 percent of the bottom area of each shaft has less than 1/2-inch of sediment or debris at the time of hole acceptance just prior to steel positioning and concrete placement. The maximum depth of sediment or any debris at any location on the bottom of the shaft shall not exceed 1-1/2 inches before beginning concrete placement.

C.2.8.8 Safety

Do not permit any worker to enter the drilled shaft excavation for any reason unless a suitable casing has been installed, the water level has been lowered and stabilized below the level to be occupied, and an adequate safety equipment and procedures have been provided to the personnel entering the excavation, which includes OSHA certification for confined-entry-space.

C.2.8.9 Test Core

Once the excavation is completed to the required minimum shaft embedment, the drilled shaft shall be cleaned of any mud, loose soils and rock. The shaft bottom should be level and contain no protuberance of rock into the limits of the shaft. Collect a test core of the rock (beginning of the drilled shaft base level) with a core diameter of not less than 2.125-inches (NQ core) and core length of not less than 10 feet and according to ASTM D2113.

The department will verify that this rock core has a recovery of at least 50 percent throughout the length cored. If the core does not meet the above requirements, the core shall be extended as directed by the engineer. Subsequently, drilled shaft embedment shall be extended to the engineer directed level. If the rock core drilling is performed prior to excavation of the drilled shaft begin the core when rock is first encountered, then extended the core to the necessary depths that meets the recovery requirements outlined above or as directed by the engineer. Prepare and submit the logs documenting any subsurface investigation borings or rock core holes performed at the drilled shaft foundation locations. Store the collected rock core samples in a wood framed core box.

After the shaft bearing level is established by the engineer, immediately grout the test core hole.

C.2.8.10 Record Information

Provide the department with all of the drilled shaft excavation records and report any unusual observation to the engineer within eight hours of discovery. Submit a draft of this form for each completed drilled shaft within 24 hours of shaft completion and submit the final form within two weeks. Submit relevant information on a daily basis, or more frequently when variation occurs, or as otherwise required by the engineer.

Report the drilled shaft construction progress conforming to "Records and Forms" Drilled Shafts: Publication No. FHWA GEC 10, Section 19.5 and Appendix F, pages F-1 through F-16.

C.2.9 Placement of Reinforcing Steel Cage

Prior to placement of the reinforcing steel and concrete, if slurry fluid was employed during the installation of the drilled shaft, test the slurry for conformance to this specification as described in the QMP, Drilled Shafts special provision. Perform Slurry Tests along the shaft and a minimum of once at the bottom of the shaft. Adjust the slurry properties as necessary to meet the specifications.

Prior to placement of the reinforcement steel and concrete, ensure that C.2.8.7 cleanliness requirements are met.

Use concrete spacers or non-corrosive spacers at sufficient intervals not exceeding 10 feet along the reinforcement cage. Space a minimum of three spacers evenly around the circumference of any shaft with a maximum space along the shaft circumference of 30 inches between any spacer, i.e., at any given level then a 5 foot diameter shaft shall have 5 spacers. Place the first spacers 1.5 feet from the bottom of the shaft with successive spacer intervals every 10 feet, maximum along the shaft. Spacers shall be of an appropriate diameter wheel to eliminate gaps between the shaft excavation walls and the steel reinforcement.

C.2.10 Concrete Placement

C.2.10.1 General

Test the concrete delivered to the job site for conformance to the QMP Drill Shafts special provision, the standard specifications and this special provision. Maintain the same concrete placement operation from the beginning to the ending of the concrete placement for each shaft.

C.2.10.2 Concrete Placement Time

Place concrete within 48 hours of completing the drilling operation for each shaft. Any variance greater than this completion time requires approval from the Bureau of Technical Services Geotechnical Unit Supervisor, or his designee.

Place concrete within three hours after excavation inspection and approval unless otherwise directed by the engineer. If the concrete is not placed within this time frame, the hole must be re-inspected and accepted by the engineer prior to concrete placement.

C.2.10.3 Concrete Placement by Free Fall

The contractor can place concrete by the free fall method, where the installation of drilled shafts is done by the dry method or the cased method if the seepage criteria is met. Allow concrete to fall a maximum of 60 feet. Do not allow under any circumstance the concrete to strike the rebar cage, steel core, or the sides of the excavation. Direct the concrete to the center of the cage or guide walls using a drop chute or similar device.

C.2.10.4 Concrete Placement by Tremie Pipes

Use tremie pipes to place the concrete inside the excavation under the following conditions:

1. Where the excavation is filled with a drilling fluid such as water or slurry;
2. Where the drilled shaft is installed on a batter; or
3. Where a dry excavation may collapse under the shock of the waves of the free falling concrete.

Always keep the discharge end of the tremie a minimum of 7 feet below the level of the fresh concrete already placed inside the excavation to maintain a seal. The concrete should flow into position by pressure through a tremie with a minimum diameter of ten inches. Seal the bottom of the tremie before lowering it into the wet excavation. If water/slurry enters the tremie pipe after concrete pouring has

started, withdraw the tremie and clean, reseal, and restart the pouring. Seal the bottom of the tremie to prevent flow into the tremie. If for some reason, the tremie is raised out of the fluid concrete or the concrete inside the drilled shaft drops down contaminating the tremie, then completely remove and clean the tremie, then replace the seal at the bottom of the tremie and lower the tremie back as far below as possible into the already placed concrete.

C.2.10.5 Concrete Placement by Concrete Pumps

Concrete pumps and concrete lines can be used to place concrete in drilled shafts rapidly. Concrete pumps are used to place concrete in shaft excavations filled with water or slurry, to pour large or deep-drilled shafts, or to deliver the concrete from a distant location.

All pump lines and connections shall be watertight and shall guide the concrete to the discharge point at the center of the rebar cage or steel core and drilled shaft excavation. The pump line can be flexible; however, its portion at the end of the line and inside the excavation must be made of rigid and heavy steel so that it will stay straight during concreting. Keep the bottom of the pump line or discharge orifice 7 feet below the surface of fluid concrete already placed to avoid sudden jumping of the pump line out of the excavation. Continue placing concrete until over pouring is evident at the top of the drilled shaft and until dark gray concrete (acceptable concrete) can be distinguished from the drilling fluid.

C.2.10.6 Casting Level

Pour concrete not less than 1 foot above the cut-off level ('overcast') to ensure that all concrete at and below cut-off level is homogeneous and free of laitance and deleterious matter.

C.2.10.7 Water Retention

Repair any cracks, joints, defects of shaft where on exposure of the structure foundation, visible running water leaks are found that would result in leakage of the foundation.

C.2.11 Construction Tolerances for Individual Shafts

Completed drilled foundation shafts constructed out of the tolerance are unacceptable. The contractor is responsible for correcting to the satisfaction of the engineer all unacceptable work. Materials, construction, work, engineering analysis, and redesign necessary to complete corrections to out-of-tolerance excavations or completed drilled shafts shall be furnished to the department without either cost or time extension for the project. Comply with the following construction tolerances:

1. The final, as constructed position of the center of the drilled shaft shall be within a maximum of 2 inches in any direction from the theoretical position shown on the plans, unless otherwise permitted by the engineer prior to construction.
2. The vertical alignment of the drilled shaft excavation shall not vary from the vertical alignment of the drilled shaft more than 1 in 200.
3. When a permanent casing is used, the diameter of the installed drilled shaft shall not be less than the diameter of the drilled shaft shown in the plans. Any conflicts due to a casing that is greater in diameter than the plan-shaft diameter shall be remedied by the contractor. No additional compensation or schedule time shall be granted to the contractor for resolving any conflicts due to oversized casings. Employ equipment and methods of excavation to complete the drilled shaft excavation to a planar bottom, and the cutting edges of the equipment used during the excavation shall be normal to equipment's vertical axis within a tolerance of 3/8-inch per foot. The bottom of the drilled shaft excavation shall be normal to the axis of the drilled shaft within 3/4-inch per foot.
4. Tolerances outlined in sections a through c herein shall be checked and finally met by the contractor prior to placement of the reinforced rebar cage inside the shaft hole.
5. After the concrete is poured, the top elevation of the built drilled foundation shaft shall be within 1 inch of the top elevation of the corresponding drilled foundation shaft on the plans, and the top of the reinforcing steel cage shall be no more than 6 inches above or no more than 3 inches below the location of the cage shown on the plans. The center of the reinforcing cage shall also be the center of the drilled shaft.

C.2.12 Acceptance for Constructed Drilled Foundation Shafts

C.2.12.1 General

The engineer will reject any drilled foundation shafts that are not constructed and installed conforming to this special provision. Rejected shafts shall be replaced or rectified by the contractor and subject to the acceptance of the engineer. This includes the removal and reinstallation of shafts and construction of additional compensation shafts, at no additional cost to the department.

C.2.12.2 Based on Specifications

The department will only accept drilled shafts for structure foundations that conform to this special provision. Drilled shafts and related work construction disregarding any specified requirement will not be accepted including:

1. Drilled shaft excavations constructed out-of-tolerance, as specified in this specification. When repair to an out-of-tolerance shaft is possible, as determined by the engineer, fix the drilled shaft to meet the tolerances before proceeding further with any drilled shaft construction. All repairs must be acceptable to the engineer before the drilled shaft work is resumed.
2. Excavation of a drilled shaft with slurry not conforming to the QMP Drilled Shafts special provision.
3. Drilled shafts exhibiting cuttings from slurry at the drilled shaft bottom showing soft, incomplete, or unclean bottoms; or presenting side sloughing and sedimentation at the bottom.
4. Shafts with honeycomb intrusions or concrete in which the fines have been washed out or water channels in concrete are present.
5. Horizontal discontinuity or severe necking in the drilled shaft concrete.
6. Quarter-moon-shaped soil intrusions on the sides of a drilled shaft.
7. Folded-in debris inside the drilled shaft.
8. Drilled shafts for which the mix design has been altered without the acceptance of the engineer, including adding of unauthorized water to a mix design to bring it to certain slump.
9. Drilled shafts constructed in a manner where concrete placement has failed to meet the required time and tolerances, or the methods of installation did not have the engineer's acceptance.
10. Drilled shafts constructed with concrete not meeting the minimum 56-day compressive strength (3500 psi) requirement.

D Measurement

The department will measure the Drilled Shaft Foundations 24-Inch bid item by the linear foot, acceptably completed.

E Payment

The department will pay for the measured quantities at the contract unit price under the following bid item:

ITEM NUMBER	DESCRIPTION	UNIT
SPV.0090.02	Drilled Shaft Foundations 24-Inch	LF

Payment for full compensation for preparing all submittals, including the Drilled Shaft Installation Plan; furnishing, installing, and removing temporary casing; furnishing and installing left-in-place casing; placing and removing temporary working surfaces and/or templates; furnishing and using drilling fluids; furnishing documentation; removing all obstructions; removing concrete due to oversizing, blowouts or protrusions from the face of the shafts; drilling the shafts, handling and disposing of the excavated, augered and cored soils, and any drilling fluids; lifting and positioning reinforcement steel, including any required wheel type spacers, boots, internal bracing of the reinforcement steel cage, and any other temporary lifting supports; and furnishing and placing the concrete for the drilled shafts to the dimensions and elevations as shown on the plans, including removal of over pour concrete.

Reinforcement bars are measured and paid under Bar Steel Reinforcement HS Structures.

56. Helical Pile, Item SPV.0090.03.

A Description

This special provision describes performing all work related to the construction of the helical piles for the passenger boarding platform.

B Materials

B.1 Helical Piles and Hardware

Helical piles and associated hardware shall be furnished by a manufacturer with an ISO9001 accredited quality control program. Submit ISO9001 documentation to the engineer a minimum of 1 week prior to beginning of pile installation.

All helical piles and associated hardware shall conform to the current ICC-ES evaluation report documenting that the pile components can safely support the design loads indicated on the drawings. Submit ICC-ES report to the engineer a minimum of 1 week prior to beginning of pile installation.

Zinc Coating: Galvanize all helical piles, and associated hardware by the hot-dip process according to ASTM A123 or ASTM A153, as applicable. Submit galvanizing documentation to the engineer a minimum of 1 week prior to beginning of helical pile installation.

Fasteners: Bolts and nuts shall conform to ASTM A307, SAE J429 Grade 5, or as required per manufacturer. Provide bolts with washers under nut and head. Hot-dip galvanize all fasteners and hardware.

B.2 Manufactured Components

Helical plate, pier lead section and extensions conforming to the applicable ICBO evaluation report.

B.3 Submittals

Prepare and submit a complete helical pile design calculation based on the loads given in the plans. The design calculations shall be signed and sealed by an engineer licensed in the State of Wisconsin.

Prepare and submit complete product data, shop drawings and installation drawings. Show fabrication and installation details for piles, including details of driving points, splices, and cap plates.

Submit the following:

1. Qualification Data: For qualified Installer from the manufacturer to install the system.
2. Certification that manufactured components comply with ICBO report ER-5110 or PFC-5551.
3. Static Pile Test Reports: Submit within three days of completing each test.
4. Pile-Driving Equipment Data: Include type, make, and rated installation torque range.
5. Pile-Driving Records: Submit within three days of driving each pile.
6. Field quality-control reports.

C Construction

C.1 General

Construct helical piles as shown on the plans and on the installation drawings provided by the helical pile supplier.

C.1.1 Project Conditions

Do not start pile-driving operations until earthwork fills have been completed or excavations have reached an elevation of 6 to 12 inches above bottom of platform.

Protect structures, underground utilities, and other construction from damage caused by pile installation.

A geotechnical report has been prepared for this Project and is available from the department for information only.

C.1.2 Construction Tolerances

Install helical piles to the location, inclination, orientation, elevation, and minimum depth shown on the drawings. Tolerances are as follows:

C.1.3 Horizontal position: plus or minus 2”

C.1.4 Elevation: plus or minus 0.5”

C.1.5 Inclination and orientation: plus or minus 1 degree

C.2 Delivery, Storage and Handling

Deliver piles to Project site in such quantities and at such times to ensure continuity of installation. Handle and store piles at Project site to prevent buckling or physical damage, according to the manufacturer's recommendations. Keep pile components clean and free from mud and foreign matter. Promptly remove damaged pile components and hardware from site.

C.3 Installation

C.3.1 Installation Equipment

The torque rating of the hydraulic gear motor used to install the helical piles shall be adequate to install the piles to their required capacity. Provide equipment with torque rating a minimum of 50 percent greater than the maximum required installation torque.

C.3.2 Installation

Continue rotary installation until both the minimum penetration as indicated on the design drawings and required torque are achieved. Contractor shall determine theoretical torque necessary to achieve the required pile design load, based on the approved torque pile capacity correlation. Adjust required installation torque, as needed, based on results of pile load tests.

Monitor applied torque during installation. Use an electronic torque monitoring instrument that has been calibrated to the specific torque motor being used. Record measured torque at 1-foot intervals of penetration, minimum. Submit torque monitoring record for each helical pile to the engineer the following day after completion of pile installation.

Provide alternative method of measuring torque during installation to verify electronic measurements; for example, by measuring the differential pressure across the ports of the torque motor.

C.3.2.1 Installation Torque

Measure installation torque using equipment calibrated to International Accreditation Service (IAS) standards within the past 6 months. Submit torque calibration documentation to the engineer a minimum of 1 week prior to beginning of pile installation.

Torque Calibration: Submit torque-pile capacity calibration documentation to the engineer a minimum of one week prior to beginning of pile installation. Provide data to substantiate the proposed torque-pile capacity calibration.

C.3.3 Field Treatment

Galvanized Surfaces: Repair and recoat zinc coating which has been field or shop cut, burned by welding, abraded, or otherwise damaged to such an extent as to expose the base metal. Thoroughly clean the damaged area by wire brushing and removing traces of welding flux and loose or cracked zinc coating prior to painting. Paint cleaned area with two coats of zinc oxide-zinc dust paint conforming to MIL-P-21035. Compound paint with a suitable vehicle in a ratio of one part zinc oxide to four parts zinc dust by weight.

C.4 Performance Tests

A minimum of two helical piles shall be performance tested for compression by a qualified testing agency. Load test to be according to the procedures described below. The locations of helical piles to be performance tested shall be approved by the engineer. All testing shall be completed prior to installation of remaining production piles. If necessary, modify required pile installation depths and torque based on results of the performance tests, as approved by the engineer.

Calibration of Loading jack and Pressure Gage: Calibrate the loading jack and pressure gage as a set before the start of testing. Recalibrate if pressure movements are suspected of being erratic. Ram travel must be long enough to enable the helical pile to deform.

Measure pile test loads using a calibrated load cell. Also measure loads using the calibrated loading jack, providing an independent check on the load cell readings. Use the lower of the two measurements to define the actual applied load.

Provide suitable temporary reaction frame constructed with steel and timber cribbing to perform performance tests. Submit reaction frame details to the engineer at least one week prior to load testing.

Provide suitable temporary reaction frame constructed with steel and timber cribbing to perform performance tests. Submit reaction frame details to the engineer at least one week prior to load testing
Provide suitable temporary reaction frame constructed with steel and timber cribbing to perform performance tests. Submit reaction frame details to the engineer at least one week prior to load testing.

The jack shall be adjusted as needed in order to maintain a constant load during each load increment. Hold each load increment for 4 minutes. Measure and record helical pile movement at 0.5, 1, 2, and 4 minutes.

The maximum test load in a performance test shall be held for 50 minutes. The jack shall be adjusted as needed to maintain a constant load. The load hold period shall start as soon as the maximum test load is applied, and the helical pile movement shall be measured and recorded at 0.5, 1, 2, 5, 10, 20, 30, 40, and 50 minutes.

The schedule of incremental loading and unloading for performance testing shall be as follows:

Cycle 1	Cycle 2	Cycle 3	Cycle 4	Cycle 5	Cycle 6
AL	0.25 DL	0.25 DL	0.25 DL	0.25 DL	0.25 DL
0.25 DL	0.50 DL	0.50 DL	0.50 DL	0.50 DL	0.50 DL
AL	AL	0.75 DL	0.75 DL	0.75 DL	0.75 DL
		AL	1.0 DL	1.0 DL	1.0 DL
			AL	1.25 DL	1.25 DL
				AL	1.50 DL
					AL

AL = Alignment Load
DL = Design Load

Prepare performance load test report for each test pile. Include a tabulation of the load test data and a graphical summary of the load-deflection curve. Include pile as-built data, photographs of the installation and load test, and conclusions indicating whether the pile meets all acceptance criteria and whether the required installation torque needs to be modified to produce acceptable piles. Submit the test report to the engineer within 48 hours of the test.

C.5 Proof Tests

All helical piles shall be proof tested by measuring installation torque. Adjust required installation torque, if necessary, based on results of performance tests. Submit installation records to the engineer the following workday.

C.5.1 Acceptance Criteria

Performance Test: A performance-tested pile shall be acceptable if: (1) the required torque is achieved, (2) the minimum penetration as indicated on the drawings is also achieved, and (3) the helical pile resists the maximum test load with a creep rate that does not exceed 2 mm in the last log cycle of time.

Proof (Torque) Test: A proof tested pile shall be acceptable if: (1) the required torque is achieved, and (2) the minimum penetration as indicated on the drawings is also achieved.

C.6 Replacement

The failure of any pile to meet the requirements specified herein will result in the rejection of the pile and the installation of another pile or piles at no additional cost at a location to be determined by the contractor, as approved by the engineer. Rejected piles become the property of the contractor and must be disposed of properly.

C.7 Quality Assurance

Installer Qualifications: A Manufacturer's authorized representative who is trained and approved for installation of units required for this Project should be on site to oversee the installation of all helical pile units.

Testing Agency Qualifications: Qualified according to ASTM E 329 for testing indicated.

Delivery Inspection List: Field inspect and prepare a verification list of each helical pile and associated hardware. Inspect all piles and components for damage. Do not incorporate materials damaged in transport from plant to site. Submit verification list to the engineer one day after delivery.

Welding Qualifications: Qualify procedures and personnel according to AWS D1.1/D1.1M, "Structural Welding Code – Steel."

Preinstallation Conference: Conduct conference at project site prior to installation of the piles and again as needed during the installation process to address any proposed changes to the installation procedures.

D Measurement

The department will measure Helical Pile by the linear foot, acceptably installed.

E Payment

The department will pay for measured quantities at the contract unit price under the following bid item:

ITEM NUMBER	DESCRIPTION	UNIT
SPV.0090.03	Helical Pile	LF

Payment is full compensation for performing all the work and quality assurance testing required to construct the helical pile foundations.

57. Marking Line Paint 4.5-Inch Yellow, Item SPV.0090.04.

A Description

This special provision describes providing and placing marking line paint 4.5-inch at the locations on the proposed platform specified in the plans according to the pertinent provisions of standard spec 646 and as hereinafter provided.

B (Vacant)

C Construction

Furnish materials and equipment conforming to standard spec 646.

D Measurement

The department will measure Marking Line Paint 4.5-Inch yellow by the linear foot, acceptably completed.

E Payment

The department will pay for measured quantities at the contract unit price under the following bid item:

ITEM NUMBER	DESCRIPTION	UNIT
SPV.0090.04	Marking Line Paint 4.5-Inch yellow	LF

Payment is full compensation for providing and installing the marking.

58. Marking Line Contrast Paint 2-Inch Black, Item SPV.0090.05.

A Description

This special provision describes providing and placing marking line contrast paint 2-inch black at the locations on the proposed platform specified in the plans according to the pertinent provisions of standard spec 646 of the Standard Specifications and as hereinafter provided.

B (Vacant)

C Construction

Apply 2 inches of black matte finish placed behind the tactile edge as the plan details show; black marking is not required on the ends.

D Measurement

The department will measure Marking Line Contrast Paint 2-Inch Black as a linear foot unit of work acceptably completed.

E Payment

The department will pay for measured quantities at the contract unit price under the following bid item:

ITEM NUMBER	DESCRIPTION	UNIT
SPV.0090.05	Marking Line Contrast Paint 2-Inch Black	LF

Payment is full compensation for providing and installing the marking.

59. Removable Intertrack Fence, Item SPV.0090.06.

A Description

This special provision describes providing a removable intertrack fence at locations the plans show.

B Materials

Furnish notched conventional metal 2-1/2" x 5'-0" Sch 40 fence posts.

Furnish fence fabric meeting the following requirements:

Mesh Opening: 1 inch mesh

Construction: No. 11 ga. aluminized

C Construction

Install posts into the concrete foundation 3' deep with 3" diameter post sleeves. Space posts at 11 feet apart.

Use a minimum of two 1/4" x 2-1/2" x 3" steel plates to secure the fence at each post. Hog wire at the top with 12 ga. wire @ 1'-6" OC.

D Measurement

The department will measure Removable Intertrack Fence by the linear foot along the base of the fence, center-to-center of posts, acceptably completed.

E Payment

The department will pay for measured quantities at the contract unit price under the following bid item:

ITEM NUMBER	DESCRIPTION	UNIT
SP.0090.06	Removable Intertrack Fence	LF

Payment is full compensation for furnishing and installing fence and posts for the intertrack fence.

60. Sanitary Sewer Pipe PVC 6-Inch, Item SPV.0090.07.

A Description

This special provision describes providing Sanitary Sewer Pipe PVC 6-Inch for sanitary sewer service laterals as the plans show including all appurtenances. Conform to Standard Specifications for Sewer and Water Construction in Wisconsin (newest edition including all addendums), hereon referred to below as the "Standard Specification," except as modified below.

B Materials

Sanitary Sewer Service Piping: Furnish ASTM D2665 Schedule 40 Pipe 6-Inch for sanitary sewer services. Sanitary sewer lateral fittings shall conform to ASTM F1866. Sanitary Sewer laterals shall have solvent weld joints conforming to ASTM D2672 and ASTM D2855. The solvent cement shall conform to ASM D2564.

Cleanout: Furnish 6" sanitary sewer service cleanout where called for in the plans. Provide and install cleanouts according to SPS Chapter 382.35. Install cleanouts and riser extensions form sewer pipes to proposed grade. Install piping so cleanouts open in direction of flow in sewer pipe. Use light duty, top loading classification cleanouts in earth or unpaved foot traffic areas; use medium duty, top-loading classification cleanouts in paved foot traffic areas; use heavy duty, top-loading classification cleanouts in vehicular traffic areas. Set cleanout frames and covers in pavement areas flush with pavement surface.

Tracer Wire: Comply with "Standard Specifications" except as amended below: Tracer wire shall be 10-gauge CCS with 30 mil HDPE insulation for direct burial. Place tracer wire at the springline of the lateral and tape to the pipe at 5-foot intervals. Connect lateral tracer wire to the sanitary main trace wire. Terminate the tracer wire at the building in a cast iron tracer wire box set to proposed grade.

C Construction

Install according to "Standard Specifications".

D Measurement

The department will measure Sanitary Sewer Pipe PVC 6-Inch by the linear foot, acceptably completed.

E Payment

The department will pay for measured quantities at the contract unit price under the following bid item:

ITEM NUMBER	DESCRIPTION	UNIT
SPV.0090.07	Sanitary Sewer Pipe PVC 6-Inch	LF

Payment is full compensation for Sanitary Sewer Pipe PVC 6-Inch, insulation, tracer wire, bends, fittings and cleanouts. Furnish necessary materials, labor, excavation, bedding, cover and backfill materials, sheathing, shoring, dewatering, testing, cleanup and all incidentals necessary to complete the work.

61. Sanitary Sewer Pipe PVC 8-Inch, Item SPV.0090.08.

A Description

This special provision describes providing Sanitary Sewer Pipe PVC 8-Inch for sanitary sewer service main as the plans show including all appurtenances. Conform to Standard Specifications for Sewer and Water Construction in Wisconsin (newest edition including all addendums), hereon referred to below as the "Standard Specification," except as modified below.

B Materials

Sanitary Sewer Service Piping: Furnish ASTM D2665 Schedule 40 Pipe 8-Inch for sanitary sewer. Sanitary sewer fittings shall conform to ASTM F1866. Sanitary Sewer laterals shall have solvent weld joints conforming to ASTM D2672 and ASTM D2855. The solvent cement shall conform to ASM D2564.

Tracer Wire: Comply with of "Standard Specifications" except as amended below: Tracer wire shall be 10-gauge CCS with 30 mil HDPE insulation for direct burial. Place tracer wire at the springline of the lateral and tape to the pipe at 5-foot intervals. Connect lateral tracer wire to the sanitary main trace wire. Terminate the tracer wire at the building in a cast iron tracer wire box set to proposed grade.

Pipe Connection to Manhole: All sanitary sewer pipe to manhole connections shall be with a flexible, watertight pipe to manhole seal meeting the requirements of ASTM C-425 and C-443.

C Construction

Install according to "Standard Specifications".

D Measurement

The department will measure Sanitary Sewer Pipe PVC 8-Inch by the linear foot, acceptably completed.

E Payment

The department will pay for measured quantities at the contract unit price under the following bid item:

ITEM NUMBER	DESCRIPTION	UNIT
SPV.0090.08	Sanitary Sewer Pipe PVC 8-Inch	LF

Payment is full compensation for Sanitary Sewer Pipe PVC 8-Inch, insulation, tracer wire, bends, fittings, and connection into existing manholes. Furnish necessary materials, labor, excavation, bedding, cover and backfill materials, sheathing, shoring, dewatering, testing, cleanup and all incidentals necessary to complete the work.

62. Concrete Barrier Temporary Precast Left In Place, Item SPV.0090.09.

A Description

This special provision describes leaving in place temporary precast reinforced concrete barrier conforming to the shape, dimensions, and details the plans show and according to the pertinent provisions of standard spec 603, these special provisions, and as hereinafter provided.

Concrete Barrier Temporary Precast Left In Place becomes property of the department after final acceptance by the engineer. Anchor pins, when used, become property of the department. Concrete barrier shall be new at initial delivery. Ownership identification shall include the department (DOT).

B Materials

Provide temporary barrier in accordance with standard spec 603.2.

C Construction

Install in accordance with standard spec 603.3.

D Measurement

The department will measure Concrete Barrier Temporary Precast Left In Place by the linear foot, acceptably completed, measured along the base of the barrier after final installation in its left-in-place location.

E Payment

The department will pay for measured quantities at the contract unit price under the following bid item:

ITEM NUMBER	DESCRIPTION	UNIT
SPV.0090.09	Concrete Barrier Temporary Precast Left In Place	LF

Payment is full compensation for initial delivery, installation, and leaving Concrete Barrier Temporary Precast on the project site.

63. Construction Staking Fence, Item SPV.0090.

A Description

This special provision describes the contractor-performed staking required for the proposed fence conforming to standard spec 650 and as follows.

B (Vacant)

C Construction

Use methods that conform to standard spec 650.3.

Set and maintain stakes as necessary to locate points along fence lines in order to install fencing as the plans show. Stakes may not be installed in a wetland.

D Measurement

The department will measure Construction Staking Fence by the linear foot, acceptably completed, measured along the base of the fence.

E Payment

The department will pay for measured quantities at the contract unit price under the following bid item:

ITEM NUMBER	DESCRIPTION	UNIT
SPV.0090.10	Construction Staking Fence	LF

The department will not make final payment for staking until the contractor submits all survey notes and computations used to establish the required lines to the engineer within 21 days of completing the work. The department will deduct from payments due the contractor for the additional costs specified in standard spec 105.6.

Payment is full compensation for locating and setting all construction stakes; for providing construction stakes; for relocating and resetting damaged or missing construction stakes.

SER-650-001 (20160831)

64. Masonry and Cast Stone Work, Item SPV.0165.01.

A Description

A.1 SUMMARY

- a. Section Includes:
 - i Lintels.
 - ii Precast concrete stone units

- iii Brick.
 - iv Mortar and grout materials.
 - v Reinforcement.
 - vi Ties and anchors.
 - vii Embedded flashing.
 - viii Accessories.
 - ix Mortar and grout mixes.
- b. Products Installed but not Furnished under this Section:
- i Cast-stone trim in unit masonry.
 - ii Stone trim units in unit masonry.
 - iii Steel lintels in unit masonry.
 - iv Steel shelf angles for supporting unit masonry.
 - v Cavity wall insulation adhered to masonry backup.

A.2 DEFINITIONS

- a. Reinforced Masonry: Masonry containing reinforcing steel in grouted cells.

A.3 PREINSTALLATION MEETINGS

- a. Preinstallation Conference: Conduct conference at Project site.

A.4 ACTION SUBMITTALS

- a. Product Data: For each type of product.
- b. Shop Drawings: For the following:
- i Masonry Units: Indicate sizes, profiles, coursing, and locations of special shapes.
 - ii Reinforcing Steel: Indicate bending, lap lengths, and placement of unit masonry reinforcing bars. Comply with ACI 315R. Indicate elevations of reinforced walls.
 - iii Fabricated Flashing: Detail corner units, end-dam units, and other special applications.
- c. Samples for Initial Selection:
- i Clay face brick
 - ii Colored mortar.
 - iii Weep/cavity vents.
- d. Samples for Verification: For each type and color of the following:
- i Clay face brick
 - ii Pigmented and colored-aggregate mortar. Make Samples using same sand and mortar ingredients to be used on Project.
 - iii Weep/cavity vents.
 - iv Cavity drainage material.
 - v Accessories embedded in masonry.
- e. Delegated Design Submittals: For masonry anchors and ties , including analysis data signed and sealed by the qualified professional engineer responsible for their preparation.
- f. Sustainable Design Submittals:

A.5 INFORMATIONAL SUBMITTALS

- a. List of Materials Used in Constructing Mockups: List generic product names together with manufacturers, manufacturers' product names, model numbers, lot numbers, batch numbers, source of supply, and other information as required to identify materials used. Include mix proportions for mortar and grout and source of aggregates.
 - i Submittal is for information only. Receipt of list does not constitute approval of deviations from the Contract Documents unless such deviations are specifically brought to the attention of Architect and approved in writing.
- b. Material Certificates: For each type of the following:
 - i Masonry units.
 - 1) Include data on material properties material test reports substantiating compliance with requirements.
 - 2) For brick, include size-variation data verifying that actual range of sizes falls within specified tolerances.
 - 3) For exposed brick, include test report for efflorescence according to ASTM C67/C67M.
 - 4) For surface-coated brick, include test report for durability of surface appearance after 50 cycles of freezing and thawing according to ASTM C67/C67M or a list of addresses of buildings in Project's area where proposed brick has been used successfully and with a history of durability.
 - 5) For masonry units used in structural masonry, include data and calculations establishing average net-area compressive strength of units.
 - ii Integral water repellent used in CMUs.
 - iii Cementitious materials. Include name of manufacturer, brand name, and type.
 - iv Mortar admixtures.
 - v Preblended, dry mortar mixes. Include description of type and proportions of ingredients.
 - vi Grout mixes. Include description of type and proportions of ingredients.
 - vii Reinforcing bars.
 - viii Joint reinforcement.
 - ix Anchors, ties, and metal accessories.
- c. Qualification Statements: For testing agency.
- d. Delegated design engineer qualifications.
- e. Mix Designs: For each type of mortar and grout. Include description of type and proportions of ingredients.
 - i Include test reports for mortar mixes required to comply with property specification. Test according to ASTM C109/C109M for compressive strength, ASTM C1506 for water retention, and ASTM C91/C91M for air content.
 - ii Include test reports, according to ASTM C1019, for grout mixes required to comply with compressive strength requirement.
- f. Statement of Compressive Strength of Masonry: For each combination of masonry unit type and mortar type, provide statement of average net-area compressive strength of masonry units, mortar type, and resulting net-area compressive strength of masonry determined according to TMS 602.
- g. Cold-Weather and Hot-Weather Procedures: Detailed description of methods, materials, and equipment to be used to comply with requirements.

2. QUALITY ASSURANCE

a. Qualifications:

- i Installers: All masonry flashing installers must complete the International Masonry Institute Flashing Upgrade training course.
- ii Delegated Design Engineer: A professional engineer who is legally qualified to practice in the State of Wisconsin and who is experienced in providing engineering services of the type indicated.
- iii Testing Agency Qualifications: Qualified according to ASTM C1093 for testing indicated.

A.6 MOCKUPS

a. Sample Panel Mockups: Build sample panels to verify selections made under Sample submittals and to demonstrate aesthetic effects. Comply with requirements in Section "Quality Requirements" for mockups.

- i Build sample panels for each type of exposed unit masonry construction typical exterior wall typical interior wall typical exterior and interior walls in sizes approximately 48 inches (1219 mm) 60 inches (1524 mm) long by 36 inches (914 mm) 48 inches (1219 mm) high by full thickness.
- ii Build sample panels facing south.
- iii Where masonry is to match existing, build panels adjacent and parallel to existing surface.
- iv Clean one-half of exposed faces of panels with masonry cleaner indicated.
- v Protect approved sample panels from the elements with weather-resistant membrane.
- vi Approval of sample panels is for color, texture, and blending of masonry units; relationship of mortar and sealant colors to masonry unit colors; tooling of joints; aesthetic qualities of workmanship; and other material and construction qualities specifically approved by Architect in writing.
 - 1) Approval of sample panels does not constitute approval of deviations from the Contract Documents contained in sample panels unless Architect specifically approves such deviations in writing.

b. Wall Mockups: Build mockups to verify selections made under Sample submittals to demonstrate aesthetic effects to set quality standards for materials and execution and to set quality standards for installation.

- i Build mockup for architect review.
- ii Build mockups for each type of exposed unit masonry construction typical exterior wall typical interior wall typical exterior and interior walls in sizes approximately 48 inches (1219 mm) 60 inches (1524 mm) 72 inches (1829 mm) 96 inches (2438 mm) long by 36 inches (914 mm) 48 inches (1219 mm) 60 inches (1524 mm) 72 inches (1829 mm) high by full thickness, including face and backup wythes and accessories.
 - 1) Include a sealant-filled joint at least 16 inches (406 mm) long in each exterior wall mockup.
 - 2) Include lower corner of window opening, framed with stone trim, at upper corner of exterior wall mockup. Make opening approximately 12 inches (305 mm) wide by 16 inches (406 mm) high.
 - 3) Include through-wall flashing installed for a 24-inch (610-mm) length in corner of exterior wall mockup approximately 16 inches (406 mm) down from top of mockup, with a 12-inch (305-mm) length of flashing left exposed to view (omit masonry above half of flashing).

- 4) Include metal wood studs, sheathing, water-resistive barrier sheathing joint-and-penetration treatment air barrier, veneer anchors, flashing, cavity drainage material, and weep holes in exterior masonry-veneer wall mockup.
- 5) Include glazed structural clay tile pre-faced CMUs clay face brick on one face of interior unit masonry wall mockup.
- iii Where masonry is to match existing, erect mockups adjacent and parallel to existing surface.
- iv Clean one-half of exposed faces of mockups with masonry cleaner as indicated.
- v Protect accepted mockups from the elements with weather-resistant membrane.
- vi Approval of mockups does not constitute approval of deviations from the Contract Documents contained in mockups unless Architect specifically approves such deviations by Change Order.
- vii Subject to compliance with requirements, approved mockups may become part of the completed Work if undisturbed at time of Substantial Completion.

A.7 DELIVERY, STORAGE, AND HANDLING

- a. Store masonry units on elevated platforms in a dry location. If units are not stored in an enclosed location, cover tops and sides of stacks with waterproof sheeting, securely tied. If units become wet, do not install until they are dry.
- b. Store cementitious materials on elevated platforms, under cover, and in a dry location. Do not use cementitious materials that have become damp.
- c. Store aggregates where grading and other required characteristics can be maintained, and contamination avoided.
- d. Deliver preblended, dry mortar mix in moisture-resistant containers. Store preblended, dry mortar mix in delivery containers on elevated platforms in a dry location or in covered weatherproof dispensing silos.
- e. Store masonry accessories, including metal items, to prevent corrosion and accumulation of dirt and oil.

A.8 FIELD CONDITIONS

- a. Protection of Masonry: During construction, cover tops of walls, projections, and sills with waterproof sheeting at end of each day's work. Cover partially completed masonry when construction is not in progress.
 - i Extend cover a minimum of 24 inches (610 mm) down both sides of walls, and hold cover securely in place.
 - ii Where one wythe of multiwythe masonry walls is completed in advance of other wythes, secure cover a minimum of 24 inches (610 mm) down face next to unconstructed wythe and hold cover in place.
- b. Do not apply uniform floor or roof loads for at least 12 hours and concentrated loads for at least three days after building masonry walls or columns.
- c. Stain Prevention: Prevent grout, mortar, and soil from staining the face of masonry to be left exposed or painted. Immediately remove grout, mortar, and soil that come in contact with such masonry.
 - i Protect base of walls from rain-splashed mud and from mortar splatter by spreading coverings on ground and over wall surface.
 - ii Protect sills, ledges, and projections from mortar droppings.
 - iii Protect surfaces of window and door frames, as well as similar products with painted and integral finishes, from mortar droppings.
 - iv Turn scaffold boards near the wall on edge at the end of each day to prevent rain from splashing mortar and dirt onto completed masonry.

- d. Cold-Weather Requirements: Do not use frozen materials or materials mixed or coated with ice or frost. Do not build on frozen substrates. Remove and replace unit masonry damaged by frost or by freezing conditions. Comply with cold-weather construction requirements contained in TMS 602.
 - i Cold-Weather Cleaning: Use liquid cleaning methods only when air temperature is 40 deg F (4 deg C) and higher and will remain so until masonry has dried, but not less than seven days after completing cleaning.
- e. Hot-Weather Requirements: Comply with hot-weather construction requirements contained in TMS 602.

B Materials

B.1 Masonry

1. SOURCE LIMITATIONS

- a. Obtain exposed masonry units cementitious mortar components and mortar aggregate from single source producer or manufacturer.
- b. For exposed masonry units and cementitious mortar components, obtain each color and grade from single source with resources to provide materials of consistent quality in appearance and physical properties.

2. PERFORMANCE REQUIREMENTS

- a. Seismic Performance: Masonry to withstand the effects of earthquake motions determined according to ASCE/SEI 7
- b. Provide structural unit masonry that develops indicated net-area compressive strengths at 28 days.
 - i Determine net-area compressive strength of masonry from average net-area compressive strengths of masonry units and mortar types (unit-strength method) according to TMS 602.
 - ii Determine net-area compressive strength of masonry by testing masonry prisms according to ASTM C1314.

3. UNIT MASONRY, GENERAL

4. BRICK

- a. Building (Common) Brick: ASTM C62, Grade SW Grade MW or Grade SW Grade NW, Grade MW, or Grade SW.
 - i Unit Compressive Strength: Provide units with minimum average net-area compressive strength of 1700 psi (11.72 MPa) 2100 psi (14.48 MPa) 3350 psi (23.10 MPa) 4150 psi (28.61 MPa) 4950 psi (34.13 MPa) 6200 psi (42.75 MPa) 6600 psi (45.51 MPa) 8250 psi (56.88 MPa).
 - ii Size (Actual Dimensions): 3-5/8 inches wide by 2-1/4 inches (57 mm) high by 7-5/8 inches long.
 - iii Application: Use where brick is indicated for concealed locations. Face brick complying with requirements for grade, compressive strength, and size indicated for building brick may be substituted for building brick.
 - iv Manufacturers: Acme Brick, Endicott Clay or approved equal.

5. REINFORCEMENT

- a. Uncoated-Steel Reinforcing Bars: ASTM A615/A615M or ASTM A996/A996M, Grade 60 (Grade 420).

- b. Reinforcing Bar Positioners: Wire units designed to fit into mortar bed joints spanning masonry unit cells and to hold reinforcing bars in center of cells. Units are formed from 0.148-inch (3.77-mm) steel wire, hot-dip galvanized after fabrication. Provide units designed for number of bars indicated.
- c. Masonry-Joint Reinforcement, General: ASTM A951/A951M.
 - i Interior Walls: Mill- Hot-dip galvanized carbon steel.
 - ii Exterior Walls: Hot-dip galvanized carbon Stainless steel.
 - iii Wire Size for Side Rods: 0.148-inch (3.77-mm) 0.187-inch (4.76-mm) diameter.
 - iv Wire Size for Cross Rods: 0.148-inch (3.77-mm) 0.187-inch (4.76-mm) diameter.
 - v Wire Size for Veneer Ties: 0.148-inch (3.77-mm) 0.187-inch (4.76-mm) diameter.
 - vi Spacing of Cross Rods, Tabs, and Cross Ties: Not more than 16 inches (406 mm) o.c.
 - vii Provide in lengths of not less than 10 ft. (3 m), with prefabricated corner and tee units.

6. TIES AND ANCHORS

- a. General: Ties and anchors extend at least 1-1/2 inches (38 mm) into veneer but with at least a 5/8-inch (16-mm) cover on outside face.
- b. Materials: Provide ties and anchors specified in this article that are made from materials that comply with the following unless otherwise indicated:
 - i Mill-Galvanized, Carbon-Steel Wire: ASTM A1064/A1064M, with ASTM A641/A641M, Class 1 coating.
 - ii Hot-Dip Galvanized, Carbon-Steel Wire: ASTM A1064/A1064M, with ASTM A153/A153M, Class B-2 coating.
 - iii Galvanized-Steel Sheet: ASTM A653/A653M, Commercial Steel, G60 (Z180) zinc coating.
 - iv Steel Sheet, Galvanized after Fabrication: ASTM A1008/A1008M, Commercial Steel, with ASTM A153/A153M, Class B coating.
- c. Corrugated-Metal Ties: Metal strips not less than 7/8 inch (22 mm) wide with corrugations having a wavelength of 0.3 to 0.5 inch (7.6 to 13 mm) and an amplitude of 0.06 to 0.10 inch (1.5 to 2.5 mm) made from 0.0336-inch- (0.85-mm-) thick steel sheet, galvanized after fabrication 0.0635-inch- (1.61-mm-) thick steel sheet, galvanized after fabrication 0.0312-inch- (0.79-mm-) thick, stainless steel sheet 0.0625-inch- (1.59 mm-) thick, stainless steel sheet.
- d. Individual Wire Ties: Rectangular units with closed ends and not less than 4 inches (100 mm) wide.
 - i Z-shaped ties with ends bent 90 degrees to provide hooks not less than 2 inches (51 mm) long for masonry constructed from solid units.
 - ii Where wythes do not align are of different materials, use adjustable ties with pintle-and-eye connections having a maximum adjustment of 1-1/4 inches (32 mm).
 - iii Wire: Fabricate from 3/16-inch- (4.76-mm-) 1/4-inch- (6.4-mm-) diameter, hot-dip galvanized steel stainless steel wire. Mill-galvanized wire ties may be used in interior walls unless otherwise indicated.
- e. Adjustable Anchors for Connecting to Structural Steel Framing: Provide anchors that allow vertical or horizontal adjustment but resist tension and compression forces perpendicular to plane of wall.
 - i Anchor Section for Welding to Steel Frame: Crimped 1/4-inch- (6.4-mm-) diameter, hot-dip galvanized steel stainless steel wire. Mill-galvanized wire may be used at interior walls unless otherwise indicated.

- ii Tie Section: Triangular-shaped wire tie made from 0.187-inch- (4.76-mm-) 0.25-inch- (6.4-mm-) diameter, hot-dip galvanized steel stainless steel wire. Mill-galvanized wire may be used at interior walls unless otherwise indicated.
- f. Adjustable Anchors for Connecting to Concrete: Provide anchors that allow vertical or horizontal adjustment but resist tension and compression forces perpendicular to plane of wall.
- i Connector Section: Dovetail Channel tabs for inserting into dovetail channel slots in concrete and attached to tie section; formed from 0.060-inch- (1.52-mm-) thick steel sheet, galvanized after fabrication 0.105-inch- (2.66-mm-) thick steel sheet, galvanized after fabrication 0.062-inch- (1.59-mm-) thick, stainless steel sheet 0.109-inch- (2.78-mm-) thick, stainless steel sheet.
 - 1) 0.064-inch- (1.63-mm-) 0.108-inch- (2.74-mm-) thick, galvanized-steel sheet may be used at interior walls unless otherwise indicated.
 - ii Tie Section: Triangular-shaped wire tie made from 0.187-inch- (4.76-mm-) 0.25-inch- (6.4-mm-) diameter, hot-dip galvanized steel stainless steel wire. Mill-galvanized wire may be used at interior walls unless otherwise indicated.
 - iii Corrugated-Metal Ties: Metal strips not less than 7/8 inch (22 mm) wide with corrugations having a wavelength of 0.3 to 0.5 inch (7.6 to 13 mm) and an amplitude of 0.06 to 0.10 inch (1.5 to 2.5 mm) made from 0.0635-inch- (1.61-mm-) thick steel sheet, galvanized after fabrication 0.0785-inch- (1.99 mm-) thick steel sheet, galvanized after fabrication 0.1084-inch- (2.75-mm-) thick steel sheet, galvanized after fabrication 0.0625-inch- (1.59-mm-) thick, stainless steel sheet 0.0781-inch- (1.98-mm-) thick, stainless steel sheet 0.1094-inch- (2.78-mm-) thick, stainless steel sheet with dovetail channel tabs for inserting into slots in concrete.
 - 1) 0.064-inch- (1.63-mm-) 0.079-inch- (2.01-mm-) 0.108-inch- (2.74-mm-) thick galvanized sheet may be used at interior walls unless otherwise indicated.
 - iv Partition Top Anchors: 0.105-inch- (2.66-mm-) thick metal plate with a 3/8-inch- (10-mm-) diameter metal rod 6 inches (152 mm) long welded to plate and with closed-end plastic tube fitted over rod that allows rod to move in and out of tube. Fabricate from steel, hot-dip galvanized after fabrication stainless steel.
 - v Rigid Anchors: Fabricate from steel bars 1-1/2 inches (38 mm) wide by 1/4 inch (6.4 mm) thick by 24 inches (610 mm) long, with ends turned up 2 inches (51 mm) or with cross pins unless otherwise indicated bent to configuration indicated.
 - 2) Corrosion Protection: Hot-dip galvanized to comply with ASTM A153/A153M Epoxy coating 0.020 inch (0.51 mm) thick Rust-inhibitive paint.
- g. Adjustable Masonry-Veneer Anchors:
- i General: Provide anchors that allow vertical adjustment but resist a 100 lbf (445 N) load in both tension and compression perpendicular to plane of wall without deforming or developing play in excess of 1/16 inch (1.6 mm).
 - ii Fabricate sheet metal anchor sections and other sheet metal parts from 0.0785-inch- (1.99-mm-) thick steel sheet, galvanized after fabrication 0.1084-inch- (2.75-mm-) thick steel sheet, galvanized after fabrication 0.0781-inch- (1.98-mm-) thick, stainless steel sheet 0.1094-inch- (2.78-mm-) thick, stainless steel sheet.
 - iii Fabricate wire ties from 0.187-inch- (4.76-mm-) 0.25-inch- (6.4-mm-) diameter, hot-dip galvanized-steel stainless steel wire unless otherwise indicated.
 - iv Contractor's Option: Unless otherwise indicated, provide any of the adjustable masonry-veneer anchors specified.
 - v Masonry-Veneer Anchors; Vertical Slotted L-Plate: Rib-stiffened, sheet metal anchor section with screw holes at top and bottom, projecting vertical leg with slotted hole for wire tie and washer at face of insulation.

- vi Masonry-Veneer Anchors; Double-Pintle Plate: Rib-stiffened, sheet metal anchor section with screw holes at top and bottom, projecting horizontal leg with slots for vertical legs of double pintle wire tie. Provide with seismic tie, clip, and continuous wire in veneer.
- vii Masonry-Veneer Anchors; Slotted Plate: Sheet metal anchor section, with screw holes at top and bottom; and raised rib-stiffened strap, stamped into center to provide a slot between strap and base for wire tie. Use self-adhering tape to seal penetration behind anchor plate.
- viii Masonry-Veneer Anchors; Slotted Plate with Prongs: Sheet metal anchor section, with screw holes at top and bottom; top and bottom ends bent to form pronged legs of length to match thickness of insulation; and raised rib-stiffened strap, stamped into center to provide a slot between strap and base for wire tie. Use self-adhering tape to seal penetration behind anchor plate.
- ix Masonry-Veneer Anchors; Single-Barrel Screw: Self-drilling, single-barrel screw designed to receive wire tie. Screw has a smooth barrel the same thickness as insulation with factory-installed gasketed washer to seal at face of insulation and sheathing and a coating to reduce thermal conductivity. Provide with seismic tie, clip, and continuous wire in veneer.
- x Masonry-Veneer Anchors; Single-Barrel Screw with Double-Pintle Wingnut: Self-drilling, single-barrel screw with wingnut head thermally resistant wingnut head thermally resistant clip designed to receive double-pintle wire tie. Screw has a smooth barrel the same thickness as insulation with factory-installed gasketed washer to seal at face of insulation and sheathing and a coating to reduce thermal conductivity. Provide with seismic tie, clip, and continuous wire in veneer.
- xi Masonry-Veneer Anchors; Seismic-Pintle Plate: Rib-stiffened, sheet metal anchor section with screw holes at top and bottom, projecting leg with slotted hole for vertical leg of seismic pintle tie. Tie is rib-stiffened, sheet metal bent plate with down-turned leg to fit in anchor slot and with integral tabs to hold continuous wire in veneer.
- xii Polymer-Coated, Steel Drill Screws for Steel Studs: ASTM C954 except manufactured with hex washer head and neoprene or EPDM washer, No. 10 (4.83 mm) diameter by length required to penetrate steel stud flange with not less than three exposed threads, and with organic polymer coating with salt-spray resistance to red rust of more than 800 hours according to ASTM B117.
- xiii Stainless Steel Drill Screws for Steel Studs: ASTM C954 except manufactured with hex washer head and neoprene or EPDM washer, No. 10 (4.83 mm) diameter by length required to penetrate steel stud flange with not less than three exposed threads; either made from Type 410 stainless steel or made with a carbon-steel drill point and 300 Series stainless steel shank.

7. EMBEDDED FLASHING

- a. Metal Flashing: Provide metal flashing complying with SMACNA's "Architectural Sheet Metal Manual" and as follows:
- b. Stainless Steel: ASTM A240/A240M or ASTM A666, Type 304 Type 316, 0.016 inch (0.40 mm) thick.
- c. Fabricate through-wall metal flashing embedded in masonry from stainless steel copper, with sawtooth ribs at 3-inch (76-mm) intervals along length of flashing to provide an integral mortar bond.
- d. Fabricate through-wall flashing with snaplock receiver on exterior face where indicated to receive counterflashing.
- e. Fabricate through-wall flashing with drip edge where unless otherwise indicated. Fabricate by extending flashing 1/2 inch (13 mm) out from wall, with outer edge bent down 30 degrees and hemmed.

- f. Fabricate through-wall flashing with sealant stop where unless otherwise indicated. Fabricate by bending metal back on itself 3/4 inch (19 mm) at exterior face of wall and down into joint 1/4 inch (6.4 mm) to form a stop for retaining sealant backer rod.
- g. Fabricate metal drip edges and sealant stops for sawtooth metal flashing from plain metal flashing of same metal as sawtooth flashing and extending at least 3 inches (76 mm) into wall with hemmed inner edge to receive sawtooth flashing and form a hooked seam. Form hem on upper surface of metal so that completed seam sheds water.
- h. Fabricate metal drip edges from stainless steel. Extend at least 3 inches (76 mm) into wall and 1/2 inch (13 mm) out from wall, with outer edge bent down 30 degrees and hemmed.
- i. Fabricate metal sealant stops from stainless steel. Extend at least 3 inches (76 mm) into wall and out to exterior face of wall. At exterior face of wall, bend metal back on itself for 3/4 inch (19 mm) and down into joint 1/4 inch (6.4 mm) to form a stop for retaining sealant backer rod.
- j. Fabricate metal expansion-joint strips from stainless steel copper to shapes indicated.
- k. Solder metal items at corners.
- l. Flexible Flashing: Use one of the following unless otherwise indicated:
- m. Stainless Steel Fabric Flashing: Composite, flashing product consisting of 2-mil (0.05-mm) of Type 304 Type 316 stainless steel sheet, bonded to a layer of polymeric fabric, to produce an overall thickness of 40-mil (1.0-mm).
- n. Self-Adhering, Stainless Steel Fabric Flashing: Composite, flashing product consisting of 2 mil (0.05 mm) of Type 304 Type 316 stainless steel sheet, bonded to a layer of polymeric fabric with a butyl adhesive permanent, clear adhesive, to produce an overall thickness of 10 mil (0.25 mm) 40 mil (1.0 mm).
 - i Applications: Use 10-mil- (0.25-mm-) thick flashing at windows, doors, and small wall penetrations; not at base of walls. Use 40-mil- (1.0-mm-) thick flashing at base of walls.
- o. Rubberized-Asphalt Flashing: Composite flashing product consisting of a pliable, adhesive rubberized-asphalt compound, bonded to a high-density, cross-laminated polyethylene film to produce an overall thickness of not less than 30 mil (0.76 mm) 40 mil (1.0 mm) 60 mil (1.5 mm).
 - i Accessories: Provide preformed corners, end dams, other special shapes, and seaming materials produced by flashing manufacturer.
- p. Butyl Rubber Flashing: Composite, self-adhesive, flashing product consisting of a pliable, butyl rubber compound, bonded to a high-density polyethylene film, aluminum foil, or spunbonded polyolefin to produce an overall thickness of not less than 35 mil (0.89 mm) 40 mil (1.0 mm).
 - i Accessories: Provide preformed corners, end dams, other special shapes, and seaming materials produced by flashing manufacturer.
- q. Elastomeric Thermoplastic Flashing: Composite flashing product consisting of a polyester-reinforced ethylene interpolymer alloy.
 - i Monolithic Sheet: Elastomeric thermoplastic flashing, 40 mil (1.0 mm) thick.
 - ii Self-Adhesive Sheet: Elastomeric thermoplastic flashing, 25 mil (0.64 mm) thick, with a 15-mil- (0.38-mm-) thick coating of adhesive.
 - 1) Color: Gray White Tan/buff Black.
 - iii Accessories: Provide preformed corners, end dams, other special shapes, and seaming materials produced by flashing manufacturer.
- r. EPDM Flashing: Sheet flashing product made from ethylene-propylene-diene terpolymer, complying with ASTM D4637/D4637M, 40 mil (1.0 mm) thick.

- s. Drainage Plane Flashing: Fabricate from stainless steel copper rubberized asphalt elastomeric membrane and drainage membrane to shapes indicated, including weep tabs, termination bar, and drip edge. Provide flashing materials as follows:
 - i Stainless Steel: ASTM A240/A240M or ASTM A666, Type 304 Type 316, 0.016 inch (0.40 mm) thick.
 - ii Copper: 3 oz./sq. ft. (0.9 kg/sq. m) 5 oz./sq. ft. (1.5 kg/sq. m) thick.
 - iii Rubberized Asphalt: 40 mil (1.0 mm) 60 mil (1.5 mm) thick.
 - iv Elastomeric Membrane: EPDM complying with ASTM D4637/D4637M PVC PVC with Elvaloy Kee TPO, 40 mil (1.0 mm) 60 mil (1.5 mm).
 - v Fabricate continuous flashings in sections 60 inches (1524 mm) long, minimum.
 - vi Accessories: Provide preformed corners, end dams, other special shapes, and seaming materials produced by flashing manufacturer.
- t. Solder and Sealants for Sheet Metal Flashings: As specified in Section "Sheet Metal Flashing and Trim."
 - i Solder for Stainless Steel: ASTM B32, Grade Sn60 Grade Sn96, with acid flux of type recommended by stainless steel sheet manufacturer.
 - ii Solder for Copper: ASTM B32, Grade Sn50 with maximum lead content of 0.2 percent.
 - iii Elastomeric Sealant: ASTM C920, chemically curing urethane polysulfide silicone sealant; of type, grade, class, and use classifications required to seal joints in sheet metal flashing and remain watertight.
- u. Adhesives, Primers, and Seam Tapes for Flashings: Flashing manufacturer's standard products or products recommended by flashing manufacturer for bonding flashing sheets to each other and to substrates.
- v. Termination Bars for Flexible Flashing: Stainless steel bars 0.075 inch by 1 inch (1.90 mm by 25 mm) 1/8 inch by 1 inch (3.2 mm by 25 mm) 1/8 inch by 1-1/8 inch (3.2 mm by 29 mm).
- w. Termination Bars for Flexible Flashing, Flanged: Stainless steel sheet 0.019 inch by 1-1/2 inches (0.48 mm by 38 mm)

8. ACCESSORIES

- a. Compressible Filler: Premolded filler strips complying with ASTM D1056, Grade 2A1; compressible up to 35 percent; of width and thickness indicated; formulated from neoprene urethane or PVC.
- b. Preformed Control-Joint Gaskets: Made from styrene-butadiene-rubber compound, complying with ASTM D2000, Designation M2AA-805 or PVC, complying with ASTM D2287, Type PVC-65406 and designed to fit standard sash block and to maintain lateral stability in masonry wall; size and configuration as indicated.
- c. Bond-Breaker Strips: Asphalt-saturated felt complying with ASTM D226/D226M, Type I (No. 15 asphalt felt).
- d. Weep/Cavity Vents: Use one of the following unless otherwise indicated:
 - i Wicking Material: Absorbent rope, made from cotton, 1/4 to 3/8 inch (6.4 to 10 mm) in diameter, in length required to produce 2-inch (51-mm) exposure on exterior and 18 inches (457 mm) in cavity. Use only for weeps.
 - ii Round Plastic Weep/Vent Tubing: Medium-density polyethylene, 3/8-inch (10-mm) OD by 4 inches (102 mm) long.
 - iii Rectangular Plastic Weep/Vent Tubing: Clear butyrate, 3/8 by 1-1/2 by 3-1/2 inches (10 by 38 by 89 mm) long.

- iv Cellular Plastic Weep/Vent: One-piece, flexible extrusion made from UV-resistant polypropylene copolymer, full height and width of head joint and depth 1/8 inch (3.2 mm) less than depth of outer wythe, in color selected from manufacturer's standard.
 - v Mesh Weep/Vent: Free-draining mesh; made from polyethylene strands, full height and width of head joint and depth 1/8 inch (3.2 mm) less than depth of outer wythe; in color selected from manufacturer's standard.
 - vi Vinyl Weep Hole/Vent: Units made from flexible PVC, designed to fit into a head joint and consisting of a louvered vertical leg, flexible wings to seal against ends of masonry units, and a top flap to keep mortar out of the head joint; in color selected by Architect.
- e. Cavity Drainage Material: Free-draining mesh, made from polymer strands that will not degrade within the wall cavity.
- i Mortar Deflector: Strips, full depth of cavity 3/4 inch (19 mm) thick 1 inch (25 mm) 1-1/2 inches (38 mm) thick 2 inches (51 mm) and 10 inches (254 mm) 16 inches (406 mm) high, with dovetail-shaped notches dimpled surface that prevent clogging with mortar droppings.
 - ii Rainscreen Drainage Mat: Sheets or strips not less than full depth of cavity 3/4 inch (19 mm) 1 inch (25 mm) 1-1/2 inches (38 mm) thick 2 inches (51 mm) thick and installed to full height of cavity, with additional strips 4 inches (102 mm) high at weep holes and thick enough to fill entire depth of cavity to prevent weep holes from clogging with mortar.
- f. Masonry Cell Fill: Loose-Fill Insulation: Perlite complying with ASTM C549, Type II (surface treated for water repellency and limited moisture absorption) or Type IV (surface treated for water repellency and to limit dust generation) Lightweight-Aggregate Fill: ASTM C331/C331M Foamed-in-place masonry cell fill.
- g. Proprietary Acidic Masonry Cleaner: Manufacturer's standard-strength cleaner designed for removing mortar/grout stains, efflorescence, and other new construction stains from new masonry without discoloring or damaging masonry surfaces. Use product expressly approved for intended use by cleaner manufacturer and manufacturer of masonry units being cleaned.

9. MORTAR AND GROUT MIXES

- a. General: Do not use admixtures, including pigments, air-entraining agents, accelerators, retarders, water-repellent agents, antifreeze compounds, or other admixtures unless otherwise indicated.
- i Do not use calcium chloride in mortar or grout.
 - ii Use portland cement-lime masonry cement or mortar cement mortar unless otherwise indicated.
 - iii For exterior masonry, use portland cement-lime masonry cement or mortar cement mortar.
 - iv For reinforced masonry, use portland cement-lime masonry cement or mortar cement mortar.
 - v Add cold-weather admixture (if used) at same rate for all mortar that will be exposed to view, regardless of weather conditions, to ensure that mortar color is consistent.
- b. Preblended, Dry Mortar Mix: Furnish dry mortar ingredients in form of a preblended mix. Measure quantities by weight to ensure accurate proportions, and thoroughly blend ingredients before delivering to Project site.
- c. Mortar for Unit Masonry: Comply with ASTM C270, Proportion Property Specification. Provide the following types of mortar for applications stated unless another type is indicated or needed to provide required compressive strength of masonry.
- i For masonry below grade or in contact with earth, use Type M.
 - ii For reinforced masonry, use Type M Type S Type N.

- iii For mortar parge coats, use Type S or Type N.
- iv For exterior, above-grade, load-bearing, nonload-bearing walls, and parapet walls; for interior load-bearing walls; for interior nonload-bearing partitions; and for other applications where another type is not indicated, use Type N.
- v For interior nonload-bearing partitions, Type O may be used instead of Type N.
- d. Pigmented Mortar: Use colored cement product or select and proportion pigments with other ingredients to produce color required. Do not add pigments to colored cement products.
 - i Pigments do not exceed 5 percent of masonry cement or mortar cement by weight.
 - ii Mix to match Architect's sample.
 - iii Application: Use pigmented mortar for exposed mortar joints.
- e. Colored-Aggregate Mortar: Produce required mortar color by using colored aggregates and natural color or white cement as necessary to produce required mortar color.
 - i Mix to match Architect's sample.
 - ii Application: Use colored-aggregate mortar for exposed mortar joints with the following units: precast concrete stone units.
- f. Grout for Unit Masonry: Comply with ASTM C476.
 - i Use grout of type indicated or, if not otherwise indicated, of type (fine or coarse) that will comply with TMS 602 for dimensions of grout spaces and pour height.
 - ii Proportion grout according to ASTM C476, Table 1 or paragraph 4.2.1.2 for specified 28-day compressive strength indicated, but not less than 2000 psi (14 MPa).
 - iii Provide grout with a slump of 8 to 11 inches (203 to 279 mm) 10 to 11 inches (254 to 279 mm) as measured according to ASTM C143/C143M.
- g. Epoxy Pointing Mortar: Mix epoxy pointing mortar to comply with mortar manufacturer's written instructions.
 - i Application: Use epoxy pointing mortar for exposed mortar joints between unit masonry with other building elements such as curtain walls and roof soffits.

C Construction

C.1 Masonry

1. EXAMINATION

- a. Examine conditions, with Installer present, for compliance with requirements for installation tolerances and other conditions affecting performance of the Work.
 - i For the record, prepare written report, endorsed by Installer, listing conditions detrimental to performance of the Work.
 - ii Verify that foundations are within tolerances specified.
 - iii Verify that reinforcing dowels are properly placed.
 - iv Verify that substrates are free of substances that impair mortar bond.
- b. Before installation, examine rough-in and built-in construction for piping systems to verify actual locations of piping connections.
- c. Proceed with installation only after unsatisfactory conditions have been corrected.

2. INSTALLATION, GENERAL

- a. Thickness: Build cavity and composite walls and other masonry construction to full thickness shown. Build single-wythe walls to actual widths of masonry units, using units of widths indicated.
- b. Build chases and recesses to accommodate items specified in this and other Sections.

- c. Leave openings for equipment to be installed before completing masonry. After installing equipment, complete masonry to match construction immediately adjacent to opening.
- d. Use full-size units without cutting if possible. If cutting is required to provide a continuous pattern or to fit adjoining construction, cut units with motor-driven saws; provide clean, sharp, unchipped edges. Allow units to dry before laying unless wetting of units is specified. Install cut units with cut surfaces and, where possible, cut edges concealed.
- e. Select and arrange units for exposed unit masonry to produce a uniform blend of colors and textures. Mix units from several pallets or cubes as they are placed.
- f. Matching Existing Masonry: Match coursing, bonding, color, and texture of existing masonry.
- g. Wetting of Brick: Wet brick before laying if initial rate of absorption exceeds 30 g/30 sq. in. (30 g/194 sq. cm) per minute when tested according to ASTM C67/C67M. Allow units to absorb water so they are damp but not wet at time of laying.

3. TOLERANCES

a. Dimensions and Locations of Elements:

- i For dimensions in cross section or elevation, do not vary by more than plus 1/2 inch (13 mm) or minus 1/4 inch (6.4 mm).
- ii For location of elements in plan, do not vary from that indicated by more than plus or minus 1/2 inch (13 mm).
- iii For location of elements in elevation, do not vary from that indicated by more than plus or minus 1/4 inch (6.4 mm) in a story height or 1/2 inch (13 mm) total.

b. Lines and Levels:

- i For bed joints and top surfaces of bearing walls, do not vary from level by more than 1/4 inch in 10 ft. (6.4 mm in 3 m), or 1/2-inch (13-mm) maximum.
- ii For conspicuous horizontal lines, such as lintels, sills, parapets, and reveals, do not vary from level by more than 1/8 inch in 10 ft. (3.2 mm in 3 m), 1/4 inch in 20 ft. (6.4 mm in 6 m), or 1/2-inch (13-mm) maximum.
- iii For vertical lines and surfaces, do not vary from plumb by more than 1/4 inch in 10 ft. (6.4 mm in 3 m), 3/8 inch in 20 ft. (10 mm in 6 m), or 1/2-inch (13-mm) maximum.
- iv For conspicuous vertical lines, such as external corners, door jambs, reveals, and expansion and control joints, do not vary from plumb by more than 1/8 inch in 10 ft. (3.2 mm in 3 m), 1/4 inch in 20 ft. (6.4 mm in 6 m), or 1/2-inch (13-mm) maximum.
- v For lines and surfaces, do not vary from straight by more than 1/4 inch in 10 ft. (6.4 mm in 3 m), 3/8 inch in 20 ft. (10 mm in 6 m), or 1/2-inch (13-mm) maximum.
- vi For vertical alignment of exposed head joints, do not vary from plumb by more than 1/4 inch in 10 ft. (6.4 mm in 3 m), or 1/2-inch (13-mm) maximum.
- vii For faces of adjacent exposed masonry units, do not vary from flush alignment by more than 1/16 inch (1.6 mm) except due to warpage of masonry units within tolerances specified for warpage of units.

c. Joints:

- i For bed joints, do not vary from thickness indicated by more than plus or minus 1/8 inch (3.2 mm), with a maximum thickness limited to 1/2 inch (13 mm).
- ii For exposed bed joints, do not vary from bed-joint thickness of adjacent courses by more than 1/8 inch (3.2 mm).
- iii For head and collar joints, do not vary from thickness indicated by more than plus 3/8 inch (10 mm) or minus 1/4 inch (6.4 mm).
- iv For exposed head joints, do not vary from thickness indicated by more than plus or minus 1/8 inch (3.2 mm). Do not vary from adjacent bed-joint and head-joint thicknesses by more than 1/8 inch (3.2 mm).

- v For exposed bed joints and head joints of stacked bond, do not vary from a straight line by more than 1/16 inch (1.6 mm) from one masonry unit to the next.

4. LAYING MASONRY WALLS

- a. Lay out walls in advance for accurate spacing of surface bond patterns with uniform joint thicknesses and for accurate location of openings, movement-type joints, returns, and offsets. Avoid using less-than-half-size units, particularly at corners, jambs, and, where possible, at other locations.
- b. Bond Pattern for Exposed Masonry: Unless otherwise indicated, lay exposed masonry in running bond stack bond one-third running bond Flemish bond English bond bond pattern indicated on Drawings; do not use units with less-than-nominal 4-inch (102-mm) horizontal face dimensions at corners or jambs.
- c. Lay concealed masonry with all units in a wythe in running bond or bonded by lapping not less than 2 inches (51 mm) 4 inches (102 mm). Bond and interlock each course of each wythe at corners. Do not use units with less-than-nominal 4-inch (102-mm) horizontal face dimensions at corners or jambs.
- d. Stopping and Resuming Work: Stop work by stepping back units in each course from those in course below; do not tooth. When resuming work, clean masonry surfaces that are to receive mortar, remove loose masonry units and mortar, and wet brick if required before laying fresh masonry.
- e. Built-in Work: As construction progresses, build in items specified in this and other Sections. Fill in solidly with masonry around built-in items.
- f. Fill space between steel frames and masonry solidly with mortar unless otherwise indicated.
- g. Build nonload-bearing interior partitions full height of story to underside of solid floor or roof structure above unless otherwise indicated.
 - i Install compressible filler in joint between top of partition and underside of structure above.
 - ii Wedge nonload-bearing partitions against structure above with small pieces of tile, slate, or metal. Fill joint with mortar after dead-load deflection of structure above approaches final position.
 - iii At fire-rated partitions, treat joint between top of partition and underside of structure above to comply with "Joint Firestopping."

5. MORTAR BEDDING AND JOINTING

- a. Lay solid masonry units and hollow brick with completely filled bed and head joints; butter ends with sufficient mortar to fill head joints and shove into place. Do not deeply furrow bed joints or slush head joints.
- b. Set firebox brick in full bed of refractory mortar with full head joints. Form joints by buttering both surfaces of adjoining brick and sliding it into place. Make joints just wide enough to accommodate variations in size of brick, approximately 1/8 inch (3.2 mm). Tool joints smooth on surfaces exposed to fire or smoke.
- c. Set cast-stone trim units in full bed of mortar with full vertical joints. Fill dowel, anchor, and similar holes.
 - i Clean soiled surfaces with fiber brush and soap powder and rinse thoroughly with clear water.
 - ii Allow cleaned surfaces to dry before setting.
 - iii Wet joint surfaces thoroughly before applying mortar.
 - iv Rake out mortar joints for pointing with sealant.

- d. Tool exposed joints slightly concave when thumbprint hard, using a jointer larger than joint thickness unless otherwise indicated.
 - i For glazed masonry units, use a nonmetallic jointer 3/4 inch (19 mm) or more in width.
- e. Cut joints flush for masonry walls to receive plaster or other direct-applied finishes (other than paint) unless otherwise indicated.
- f. Cut joints flush where indicated to receive waterproofing cavity wall insulation air barriers unless otherwise indicated.
- g. Bond wythes of composite masonry together using one of the following methods as follows:
 - i Individual Metal Ties: Provide ties as indicated installed in horizontal joints, but not less than one metal tie for 4.5 sq. ft. (0.42 sq. m) 2.67 sq. ft. (0.25 sq. m) 1.77 sq. ft. (0.16 sq. m) of wall area spaced not to exceed 36 inches (914 mm) 24 inches (610 mm) 16 inches (406 mm) o.c. horizontally and 16 inches (406 mm) o.c. vertically. Stagger ties in alternate courses. Provide additional ties within 12 inches (305 mm) of openings and space not more than 36 inches (914 mm) apart around perimeter of openings. At intersecting and abutting walls, provide ties at no more than 24 inches (610 mm) o.c. vertically.
 - 1) Where bed joints of wythes do not align, use adjustable-type (two-piece-type) ties.
 - ii Masonry-Joint Reinforcement: Installed in horizontal mortar joints.
 - 2) Where bed joints of both wythes align, use ladder-type reinforcement extending across both wythes tab-type reinforcement.
 - 3) Where bed joints of wythes do not align, use adjustable-type (two-piece-type) reinforcement with continuous horizontal wire in facing wythe attached to ties.
 - iii Header Bonding: Provide masonry unit headers extending not less than 3 inches (76 mm) into each wythe. Space headers not more than 8 inches (200 mm) 12 inches (300 mm) clear horizontally and 16 inches (400 mm) clear vertically.
- h. Bond wythes of composite masonry together using bonding system indicated on Drawings.
 - i Collar Joints: Solidly fill collar joints by parging face of first wythe that is laid and shoving units of other wythe into place.
 - j. Collar Joints in Clay Tile Masonry: After each course is laid, fill the vertical, longitudinal joint between wythes solidly with mortar at exterior walls, except cavity walls, and interior walls and partitions.
- k. Corners: Provide interlocking masonry unit bond in each wythe and course at corners unless otherwise indicated.
 - i Provide continuity with masonry-joint reinforcement at corners by using prefabricated L-shaped units as well as masonry bonding.
- l. Intersecting and Abutting Walls: Unless vertical expansion or control joints are indicated at juncture, bond walls together as follows:
 - i Provide individual metal ties not more than 8 inches (203 mm) 16 inches (406 mm) o.c.
 - ii Provide continuity with masonry-joint reinforcement by using prefabricated T-shaped units.
 - iii Provide rigid metal anchors not more than 24 inches (610 mm) 48 inches (1219 mm) o.c. If used with hollow masonry units, embed ends in mortar-filled cores.

6. CAVITY WALLS

- a. Bond wythes of cavity walls together using one of the following methods as follows:
 - i Individual Metal Ties: Provide ties as indicated installed in horizontal joints, but not less than one metal tie for 4.5 sq. ft. (0.42 sq. m) 2.67 sq. ft. (0.25 sq. m) 1.77 sq. ft. (0.16 sq. m) of wall area spaced not to exceed 36 inches (914 mm) 24 inches (610 mm) 16 inches (406 mm) o.c. horizontally and 16 inches (406 mm) o.c. vertically. Stagger ties in alternate courses. Provide additional ties within 12 inches (305 mm) of openings and space not more than 36 inches (914 mm) apart around perimeter of openings. At intersecting and abutting walls, provide ties at no more than 24 inches (610 mm) o.c. vertically.
 - 1) Where bed joints of wythes do not align, use adjustable-type (two-piece-type) ties.
 - 2) Where one wythe is of clay masonry and the other of concrete masonry, use adjustable-type (two-piece-type) ties to allow for differential movement regardless of whether bed joints align.
 - ii Masonry-Joint Reinforcement: Installed in horizontal mortar joints.
 - 1) Where bed joints of both wythes align, use ladder-type reinforcement extending across both wythes tab-type reinforcement.
 - 2) Where bed joints of wythes do not align, use adjustable-type (two-piece-type) reinforcement with continuous horizontal wire in facing wythe attached to ties.
 - 3) Where one wythe is of clay masonry and the other of concrete masonry, use adjustable-type (two-piece-type) reinforcement with continuous horizontal wire in facing wythe attached to ties to allow for differential movement regardless of whether bed joints align.
 - iii Header Bonding: Provide masonry unit headers extending not less than 3 inches (76 mm) into each wythe. Space headers not more than 8 inches (203 mm) 12 inches (305 mm) clear horizontally and 16 inches (406 mm) clear vertically.
 - iv Masonry-Veneer Anchors: Comply with requirements for anchoring masonry veneers.
- b. Bond wythes of cavity walls together using bonding system indicated on Drawings.
- c. Keep cavities clean of mortar droppings and other materials during construction. Bevel beds away from cavity, to minimize mortar protrusions into cavity. Do not attempt to trowel or remove mortar fins protruding into cavity.
- d. Parge cavity face of backup wythe in a single coat approximately 3/8 inch (10 mm) thick. Trowel face of parge coat smooth.

7. ANCHORED MASONRY VENEERS

- a. Anchor masonry veneers to wall framing and concrete and masonry backup with seismic masonry-veneer anchors to comply with the following requirements:
 - i Fasten screw-attached and seismic anchors through sheathing to wall framing and to concrete and masonry backup with metal fasteners of type indicated. Use two fasteners unless anchor design only uses one fastener.
 - ii Embed tie sections connector sections and continuous wire in masonry joints.
 - iii Locate anchor sections to allow maximum vertical differential movement of ties up and down.
 - iv Space anchors as indicated, but not more than 18 inches (457 mm) o.c. vertically and 24 inches (610 mm) o.c. horizontally, with not less than one anchor for each 2 sq. ft. (0.2 sq. m) of wall area. Install additional anchors within 12 inches (305 mm) of openings and at intervals, not exceeding 8 inches (203 mm), around perimeter.

- v Space anchors as indicated, but not more than 16 inches (406 mm) o.c. vertically and 25 inches (635 mm) o.c. horizontally, with not less than one anchor for each 2.67 sq. ft. (0.25 sq. m) 3.5 sq. ft. (0.33 sq. m) of wall area. Install additional anchors within 12 inches (305 mm) of openings and at intervals, not exceeding 36 inches (914 mm), around perimeter.
 - vi Space anchors as indicated, but not more than 18 inches (457 mm) o.c. vertically and horizontally. Install additional anchors within 12 inches (305 mm) of openings and at intervals, not exceeding 24 inches (610 mm), around perimeter.
- b. Provide not less than 2 inches (51 mm) 1 inch (25 mm) of airspace between back of masonry veneer and face of sheathing insulation.
- i Keep airspace clean of mortar droppings and other materials during construction. Bevel beds away from airspace, to minimize mortar protrusions into airspace. Do not attempt to trowel or remove mortar fins protruding into airspace.

8. MASONRY-JOINT REINFORCEMENT

- a. General: Install entire length of longitudinal side rods in mortar with a minimum cover of 5/8 inch (16 mm) on exterior side of walls, 1/2 inch (13 mm) elsewhere. Lap reinforcement a minimum of 6 inches (152 mm).
- i Space reinforcement not more than 16 inches (406 mm) o.c.
 - ii Space reinforcement not more than 8 inches (203 mm) o.c. in foundation walls and parapet walls.
 - iii Provide reinforcement not more than 8 inches (203 mm) above and below wall openings and extending 12 inches (305 mm) beyond openings in addition to continuous reinforcement.
- b. Interrupt joint reinforcement at control and expansion joints unless otherwise indicated.
- c. Provide continuity at wall intersections by using prefabricated T-shaped units.
- d. Provide continuity at corners by using prefabricated L-shaped units.
- e. Cut and bend reinforcing units as directed by manufacturer for continuity at corners, returns, offsets, column fireproofing, pipe enclosures, and other special conditions.

9. ANCHORING MASONRY TO STRUCTURAL STEEL AND CONCRETE

- a. Anchor masonry to structural steel and concrete, where masonry abuts or faces structural steel or concrete, to comply with the following:
- i Provide an open space not less than 1/2 inch (13 mm) 1 inch (25 mm) 2 inches (51 mm) wide between masonry and structural steel or concrete unless otherwise indicated. Keep open space free of mortar and other rigid materials.
 - ii Anchor masonry with anchors embedded in masonry joints and attached to structure.
 - iii Space anchors as indicated, but not more than 24 inches (610 mm) o.c. vertically and 36 inches (914 mm) o.c. horizontally.

10. CONTROL AND EXPANSION JOINTS

- a. General: Install control- and expansion-joint materials in unit masonry as masonry progresses. Do not allow materials to span control and expansion joints without provision to allow for in-plane wall or partition movement.
- b. Form control joints in concrete masonry as follows using one of the following methods:
- i Fit bond-breaker strips into hollow contour in ends of CMUs on one side of control joint. Fill resultant core with grout, and rake out joints in exposed faces for application of sealant.
 - ii Install preformed control-joint gaskets designed to fit standard sash block.

- iii Install interlocking units designed for control joints. Install bond-breaker strips at joint. Keep head joints free and clear of mortar or rake out joint for application of sealant.
 - iv Install temporary foam-plastic filler in head joints and remove filler when unit masonry is complete for application of sealant.
- c. Form expansion joints in brick as follows:
- i Build flanges of metal expansion strips into masonry. Lap each joint 4 inches (102 mm) in direction of water flow. Seal joints below grade and at junctures with horizontal expansion joints if any.
 - ii Build flanges of factory-fabricated, expansion-joint units into masonry.
 - iii Build in compressible joint fillers where indicated.
 - iv Form open joint full depth of brick and of width indicated, but not less than 3/8 inch (10 mm) 1/2 inch (13 mm) for installation of sealant and backer rod specified in Section "Joint Sealants."
- d. Provide horizontal, pressure-relieving joints by either leaving an airspace or inserting a compressible filler of width required for installing sealant and backer rod specified in Section "Joint Sealants," but not less than 3/8 inch (10 mm) .
- i Locate horizontal, pressure-relieving joints beneath shelf angles supporting masonry.

11. LINTELS

- a. Install steel lintels where indicated.
- b. Provide concrete masonry or offset angle support lintels where indicated and where openings of more than 12 inches (305 mm) for brick-size units and 24 inches (610 mm) for block-size units are indicated without structural steel or other supporting lintels.
- c. Provide minimum bearing of 8 inches (203 mm) at each jamb unless otherwise indicated.

12. FLASHING, WEEP HOLES, AND CAVITY VENTS

- a. General: Install embedded flashing and weep holes in masonry at shelf angles, lintels, ledges, other obstructions to downward flow of water in wall, and where indicated. Install cavity vents at shelf angles, ledges, and other obstructions to upward flow of air in cavities, and where indicated.
- b. Install flashing as follows unless otherwise indicated:
 - i Prepare masonry surfaces so they are smooth and free from projections that could puncture flashing. Where flashing is within mortar joint, place through-wall flashing on sloping bed of mortar and cover with mortar. Before covering with mortar, seal penetrations in flashing with adhesive, sealant, or tape as recommended by flashing manufacturer.
 - ii At multiwythe masonry walls, including cavity walls, extend flashing through outer wythe, turned up a minimum of 4 inches (102 mm) 8 inches (203 mm), and through inner wythe to within 1/2 inch (13 mm) of the interior face of wall in exposed masonry. Where interior face of wall is to receive furring or framing, carry flashing completely through inner wythe and turn flashing up approximately 2 inches (51 mm) on interior face.
 - iii At multiwythe masonry walls, including cavity walls, extend flashing through outer wythe, turned up a minimum of 4 inches (102 mm) 8 inches (203 mm), and 1-1/2 inches (38 mm) into the inner wythe. Form 1/4-inch (6.4-mm) hook in edge of flashing embedded in inner wythe.
 - iv At masonry-veneer walls, extend flashing through veneer, across airspace behind veneer, and up face of sheathing at least 8 inches (203 mm); with upper edge tucked under water-resistive barrier air barrier, lapping at least 4 inches (102 mm). Fasten upper edge of flexible flashing to sheathing through termination bar.

- v At lintels and shelf angles, extend flashing 6 inches (152 mm) minimum, to edge of next full unit at each end. At heads and sills, extend flashing 6 inches (152 mm) minimum, to edge of next full unit and turn ends up not less than 2 inches (51 mm) to form end dams.
 - vi Interlock end joints of sawtooth sheet metal flashing by overlapping ribs not less than 1-1/2 inches (38 mm) or as recommended by flashing manufacturer, and seal lap with elastomeric sealant complying with requirements in Section "Joint Sealants" for application indicated.
 - vii Install metal drip edges and sealant stops with sawtooth sheet metal flashing by interlocking hemmed edges to form hooked seam. Seal seam with elastomeric sealant complying with requirements in Section "Joint Sealants" for application indicated.
 - viii Install metal drip edges beneath flexible flashing at exterior face of wall. Stop flexible flashing 1/2 inch (13 mm) back from outside face of wall and adhere flexible flashing to top of metal drip edge.
 - ix Install metal flashing termination beneath flexible flashing at exterior face of wall. Stop flexible flashing 1/2 inch (13 mm) back from outside face of wall and adhere flexible flashing to top of metal flashing termination.
 - x Cut flexible flashing off flush with face of wall after masonry wall construction is completed.
- c. Install single-wythe CMU flashing system in bed joints of CMU walls where indicated to comply with manufacturer's written instructions. Install CMU cell pans with upturned edges located below face shells and webs of CMUs above and with weep spouts aligned with face of wall. Install CMU web covers so that they cover upturned edges of CMU cell pans at CMU webs and extend from face shell to face shell.
 - d. Install reglets and nailers for flashing and other related construction where they are indicated to be built into masonry.
 - e. Install weep holes in exterior wythes and veneers in head joints of first course of masonry immediately above embedded flashing.
 - i Use specified weep/cavity vent products or open-head joints to form weep holes.
 - ii Use wicking material to form weep holes above flashing under brick sills. Turn wicking down at lip of sill to be as inconspicuous as possible.
 - iii Space weep holes 24 inches (610 mm) o.c. unless otherwise indicated.
 - iv Space weep holes formed from plastic tubing or wicking material 16 inches (406 mm) o.c.
 - v Cover cavity side of weep holes with plastic insect screening at cavities insulated with loose-fill insulation.
 - vi Trim wicking material flush with outside face of wall after mortar has set.
 - f. Place pea gravel in cavities as soon as practical to a height equal to height of first course above top of flashing, but not less than 2 inches (51 mm), to maintain drainage.
 - i Fill cavities full height by placing pea gravel in cavities as masonry is laid, so that at any point, masonry does not extend more than 24 inches (610 mm) above top of pea gravel.
 - g. Place cavity drainage material in cavities airspace behind veneers to comply with configuration requirements for cavity drainage material in "Accessories" Article.
 - h. Install cavity vents in head joints in exterior wythes at spacing indicated. Use specified weep/cavity vent products or open-head joints to form cavity vents.
 - i Close cavities off vertically and horizontally with blocking in manner indicated. Install through-wall flashing and weep holes above horizontal blocking.

13. REINFORCED UNIT MASONRY

- a. Temporary Formwork and Shores: Construct formwork and shores as needed to support reinforced masonry elements during construction.
 - i Construct formwork to provide shape, line, and dimensions of completed masonry as indicated. Make forms sufficiently tight to prevent leakage of mortar and grout. Brace, tie, and support forms to maintain position and shape during construction and curing of reinforced masonry.
 - ii Do not remove forms and shores until reinforced masonry members have hardened sufficiently to carry their own weight and that of other loads that may be placed on them during construction.
- b. Placing Reinforcement: Comply with requirements in TMS 602.
- c. Grouting: Do not place grout until entire height of masonry to be grouted has attained enough strength to resist grout pressure.
 - i Comply with requirements in TMS 602 for cleanouts and for grout placement, including minimum grout space and maximum pour height.
 - ii Limit height of vertical grout pours to not more than 60 inches (1524 mm) 12.67 ft. (3.86 m) .

14. FIELD QUALITY CONTROL

- a. Testing Agency: Engage a qualified testing agency to perform tests and inspections. Allow inspectors access to scaffolding and work areas as needed to perform tests and inspections. Retesting of materials that fail to comply with specified requirements will be at contractor's expense.
- b. Inspections: Special inspections according to Level 2 Level 3 in TMS 402.
 - i Begin masonry construction only after inspectors have verified proportions of site-prepared mortar.
 - ii Place grout only after inspectors have verified compliance of grout spaces and of grades, sizes, and locations of reinforcement.
 - iii Place grout only after inspectors have verified proportions of site-prepared grout.
- c. Testing Prior to Construction: One set of tests.
- d. Testing Frequency: One set of tests for each 5000 sq. ft. (464 sq. m) of wall area or portion thereof.
- e. Clay Masonry Unit Test: For each type of unit provided, according to ASTM C67/C67M for compressive strength.
- f. Mortar Aggregate Ratio Test (Proportion Specification): For each mix provided, according to ASTM C780.
- g. Mortar Test (Property Specification): For each mix provided, according to ASTM C780. Test mortar for mortar air content and compressive strength.
- h. Grout Test (Compressive Strength): For each mix provided, according to ASTM C1019.
- i. Prism Test: For each type of construction provided, according to ASTM C1314 at 7 days and at 28 days.

15. PARGING

- a. Parge exterior faces of below-grade masonry walls, where indicated, in two uniform coats to a total thickness of 3/4 inch (19 mm). Dampen wall before applying first coat and scarify first coat to ensure full bond to subsequent coat.
- b. Use a steel-trowel finish to produce a smooth, flat, dense surface with a maximum surface variation of 1/8 inch per foot (3.2 mm per 305 mm). Form a wash at top of parging and a cove at bottom.

- c. Damp-cure parging for at least 24 hours and protect parging until cured.

16. REPAIRING, POINTING, AND CLEANING

- a. Remove and replace masonry units that are loose, chipped, broken, stained, or otherwise damaged or that do not match adjoining units. Install new units to match adjoining units; install in fresh mortar, pointed to eliminate evidence of replacement.
- b. Pointing: During the tooling of joints, enlarge voids and holes, except weep holes, and completely fill with mortar. Point up joints, including corners, openings, and adjacent construction, to provide a neat, uniform appearance. Prepare joints for sealant application, where indicated.
- c. In-Progress Cleaning: Clean unit masonry as work progresses by dry brushing to remove mortar fins and smears before tooling joints.
- d. Final Cleaning: After mortar is thoroughly set and cured, clean exposed masonry as follows:
 - i. Remove large mortar particles by hand with wooden paddles and nonmetallic scrape hoes or chisels.
 - ii. Test cleaning methods on sample wall panel; leave one-half of panel uncleaned for comparison purposes. Obtain Architect's approval of sample cleaning before proceeding with cleaning of masonry.
 - iii. Protect adjacent stone and nonmasonry surfaces from contact with cleaner by covering them with liquid strippable masking agent or polyethylene film and waterproof masking tape.
 - iv. Wet wall surfaces with water before applying cleaners; remove cleaners promptly by rinsing surfaces thoroughly with clear water.
 - v. Clean brick by bucket-and-brush hand-cleaning method described in BIA Technical Notes 20.
 - vi. Clean concrete masonry by applicable cleaning methods indicated in NCMA TEK 8-4A.
 - vii. Clean masonry with a proprietary acidic masonry cleaner applied according to manufacturer's written instructions.

17. MASONRY WASTE DISPOSAL

- a. Salvageable Materials: Unless otherwise indicated, excess masonry materials are contractor's property. At completion of unit masonry work, remove from Project site.
- b. Waste Disposal as Fill Material: Dispose of clean masonry waste, including excess or soil-contaminated sand, waste mortar, and broken masonry units, by crushing and mixing with fill material as fill is placed.
 - i. Crush masonry waste to less than 4 inches (102 mm) in each dimension.
 - ii. Mix masonry waste with at least two parts of specified fill material for each part of masonry waste. Fill material is specified in Section "Earth Moving."
 - iii. Do not dispose of masonry waste as fill within 18 inches (457 mm) of finished grade.
- c. Masonry Waste Recycling: Return broken CMUs not used as fill to manufacturer for recycling.
- d. Excess Masonry Waste: Remove excess clean masonry waste that cannot be used as fill, as described above or recycled, and other masonry waste, and legally dispose of off Owner's property.

C.2 Description – Cast Stone

1. SUMMARY

- a. Section Includes:
 - i Trim units.
 - ii Mortar materials.
 - iii Accessories.

2. ACTION SUBMITTALS

- a. Product Data: For each type of product.
 - i For cast stone units, include construction details, material descriptions, dimensions of individual components and profiles, and finishes.
- b. Sustainable Design Submittals:
- c. Shop Drawings: Show fabrication and installation details for cast stone units. Include dimensions, details of reinforcement and anchorages if any, and indication of finished faces.
 - i Include building elevations showing layout of units and locations of joints and anchors.
- d. Samples for Initial Selection: For colored mortar.
- e. Samples for Verification:
 - i For each color and texture of cast stone required, 4 inches (100 mm) in size.
 - ii For each trim shape required, 4 inches (100 mm) in length.
 - iii Make Samples from materials to be used for units used on Project immediately before beginning production of units for Project.
 - iv Approved Samples may be installed in the Work.

3. INFORMATIONAL SUBMITTALS

- a. Qualification Data: For manufacturer
- b. Material Test Reports: For each mix required to produce cast stone, based on testing according to ASTM C1364.
 - i Provide test reports based on testing within previous six months.

4. QUALITY ASSURANCE

- a. Manufacturer Qualifications: A qualified manufacturer of cast stone units similar to those indicated for this Project, that has sufficient production capacity to manufacture required units, and is a plant certified by CSI or APA or PCI for Group A, Category AT.
- b. Furnish cast stone for installation in mockups specified in Section "Unit Masonry." Section "Masonry Veneer."
- c. Mockups: Build mockups to verify selections made under Sample submittals and to demonstrate aesthetic effects and to set quality standards for materials and execution.
- d. Build mockup for installation including accessories.
- e. Size: As indicated on Drawings.
- f. Approval of mockups does not constitute approval of deviations from the Contract Documents contained in mockups unless Architect specifically approves such deviations in writing.
- g. Subject to compliance with requirements, approved mockups may become part of the completed Work if undisturbed at time of Substantial Completion.

5. DELIVERY, STORAGE, AND HANDLING

- a. Coordinate delivery of cast stone with unit masonry work to avoid delaying the Work and to minimize the need for on-site storage.
- b. Pack, handle, and ship cast stone units in suitable packs or pallets.
 - i. Lift with wide-belt slings; do not use wire rope or ropes that might cause staining. Move cast stone units if required, using dollies with wood supports.
 - ii. Store cast stone units on wood skids or pallets with nonstaining, waterproof covers, securely tied. Arrange to distribute weight evenly and to prevent damage to units. Ventilate under covers to prevent condensation.
- c. Store cementitious materials on elevated platforms, under cover, and in a dry location. Do not use cementitious materials that have become damp.
- d. Store mortar aggregates where grading and other required characteristics can be maintained and contamination can be avoided.

6. PROJECT CONDITIONS

- a. Cold-Weather Requirements: Do not use frozen materials or materials mixed or coated with ice or frost. Do not build on frozen substrates. Comply with cold-weather construction requirements in TMS 602.
 - i. Cold-Weather Cleaning: Use liquid cleaning methods only when air temperature is 40 deg F (4 deg C) and above and will remain so until cast stone has dried, but no fewer than seven days after completing cleaning.
- b. Hot-Weather Requirements: Comply with hot-weather construction requirements in TMS 602.

C.3 Materials - Cast Stone

1. MANUFACTURERS

- a. Source Limitations for Cast Stone: Obtain cast stone units from single source from single manufacturer.
- b. Source Limitations for Mortar Materials: Obtain mortar ingredients of a uniform quality, including color, from one manufacturer for each cementitious component and from one source or producer for each aggregate.

2. CAST STONE MATERIALS

- a. General: Comply with ASTM C1364.
- b. Portland Cement: ASTM C150/C150M, Type I or Type III, containing not more than 0.60 percent total alkali when tested according to ASTM C114. Provide natural color or white cement as required to produce cast stone color indicated.
- c. Coarse Aggregates: Granite, quartz, or limestone complying with ASTM C33/C33M; gradation and colors as needed to produce required cast stone textures and colors.
- d. Fine Aggregates: Natural sand or crushed stone complying with ASTM C33/C33M, gradation and colors as needed to produce required cast stone textures and colors.
- e. Color Pigment: ASTM C979/C979M, synthetic mineral-oxide pigments or colored water-reducing admixtures; color stable, free of carbon black, nonfading, and resistant to lime and other alkalis.
- f. Admixtures: Use only admixtures specified or approved in writing by Architect.
 - i. Do not use admixtures that contain more than 0.1 percent water-soluble chloride ions by mass of cementitious materials. Do not use admixtures containing calcium chloride.
 - ii. Use only admixtures that are certified by manufacturer to be compatible with cement and other admixtures used.

- iii Air-Entraining Admixture: ASTM C260/C260M. Add to mixes for units exposed to the exterior at manufacturer's prescribed rate to result in an air content of 4 to 6 percent, except do not add to zero-slump concrete mixes.
 - iv Water-Reducing Admixture: ASTM C494/C494M, Type A.
 - v Water-Reducing, Retarding Admixture: ASTM C494/C494M, Type D.
 - vi Water-Reducing, Accelerating Admixture: ASTM C494/C494M, Type E.
- g. Reinforcement:
- i Deformed steel bars complying with ASTM A615/A615M, Grade 40 (Grade 280). Use galvanized or epoxy-coated reinforcement when covered with less than 1-1/2 inches (38 mm) of cast stone material.
 - 1) Galvanized Coating: ASTM A767/A767M.
 - ii Plain-Steel, Welded-Wire Reinforcement: ASTM A1064/A1064M, plain, fabricated from as-drawn steel wire into flat sheets.
 - iii Galvanized-Steel, Welded-Wire Reinforcement: ASTM A1064/A1064M, plain, fabricated from galvanized-steel wire into flat sheets.
 - iv Fiber Reinforcement: ASTM C1116/C1116M.
- h. Embedded Anchors and Other Inserts: Fabricated from stainless steel complying with ASTM A240/A240M, ASTM A276/A276M, or ASTM A666, Type 304 stainless steel complying with ASTM A240/A240M, ASTM A276/A276M, or ASTM A666, Type 316 steel complying with ASTM A36/A36M and hot-dip galvanized to comply with ASTM A123/A123M.
3. CAST STONE UNITS
- a. Cast Stone Units: Comply with ASTM C1364.
- i Units are manufactured using the manufacturer's selected vibrant dry tamp wet-cast machine-made method.
 - 1) Engravings: As indicated on Drawings.
 - ii Trim units including window sills lintels mullions copings cornices wall caps belt courses
- b. Fabricate units with sharp arris and accurately reproduced details, with indicated texture on all exposed surfaces unless otherwise indicated.
- i Slope exposed horizontal surfaces 1:12 to drain unless otherwise indicated.
 - ii Provide raised fillets at backs of sills and at ends indicated to be built into jambs.
 - iii Provide drips on projecting elements unless otherwise indicated.
- c. Fabrication Tolerances:
- i Variation in Cross Section: Do not vary from indicated dimensions by more than 1/8 inch (3 mm).
 - ii Variation in Length: Do not vary from indicated dimensions by more than 1/360 of the length of unit or 1/8 inch (3 mm), whichever is greater, but in no case by more than 1/4 inch (6 mm).
 - iii Warp, Bow, and Twist: Not to exceed 1/360 of the length of unit or 1/8 inch (3 mm), whichever is greater.
 - iv Location of Grooves, False Joints, Holes, Anchorages, and Similar Features: Do not vary from indicated position by more than 1/8 inch (3 mm) on formed surfaces of units and 3/8 inch (10 mm) on unformed surfaces.

- d. Cure Units as Follows:
 - i. Cure units in enclosed, moist curing room at 95 percent relative humidity and temperature of 100 deg F (38 deg C) for 12 hours or 70 deg F (21 deg C) for 16 hours.
 - ii. Keep units damp and continue curing to comply with one of the following:
 - 2) No fewer than five days at mean daily temperature of 70 deg F (21 deg C) or above.
 - 3) No fewer than seven days at mean daily temperature of 50 deg F (10 deg C) or above.
- e. Acid etch units after curing to remove cement film from surfaces to be exposed to view.
- f. Colors and Textures: Match Architect's samples Match existing units As selected by Architect from manufacturer's full range.

4. MORTAR MATERIALS

- a. Provide mortar materials that comply with Section "Unit Masonry." Section "Masonry Veneer."
- b. Portland Cement: ASTM C150/C150M, Type I or II, except Type III may be used for cold-weather construction. Provide natural color or white cement as required to produce mortar color indicated.
- c. Hydrated Lime: ASTM C207, Type S.
- d. Portland Cement-Lime Mix: Packaged blend of portland cement and hydrated lime containing no other ingredients.
- e. Masonry Cement: ASTM C91/C91M.
- f. Mortar Pigments: Natural and synthetic iron oxides and chromium oxides, compounded for use in mortar mixes and complying with ASTM C979/C979M. Use only pigments with a record of satisfactory performance in masonry mortar.
- g. Colored Cement Products: Packaged blend made from portland cement and hydrated lime masonry cement or mortar cement and mortar pigments, all complying with specified requirements, and containing no other ingredients.
 - i. Colored Portland Cement-Lime Mix:
 - ii. Colored Masonry Cement:
 - iii. Formulate blend as required to produce color indicated or, if not indicated, as selected from manufacturer's standard colors.
 - iv. Pigments do not exceed 10 percent of portland cement by weight.
 - v. Pigments do not exceed 5 percent of masonry cement or mortar cement by weight.
- h. Preblended Dry Mortar Mix: Packaged blend made from portland cement and hydrated lime masonry cement or mortar cement, sand, mortar pigments, water repellents, and admixtures and complying with ASTM C1714/C1714M.
 - i. Preblended Dry Portland Cement Mortar Mix:
 - ii. Preblended Dry Masonry Cement Mortar Mix:
- i. Aggregate for Mortar: ASTM C144.
 - i. For mortar that is exposed to view, use washed aggregate consisting of natural sand or crushed stone.
 - ii. For joints less than 1/4 inch (6 mm) thick, use aggregate graded with 100 percent passing the No. 16 (1.18-mm) sieve.
 - iii. White-Mortar Aggregates: Natural white sand or crushed white stone.
 - iv. Colored Aggregates: Natural sand or crushed stone of color necessary to produce required mortar color.

j. Water: Potable.

5. ACCESSORIES

- a. Anchors: Type and size indicated, fabricated from Type 304 stainless steel complying with ASTM A240/A240M, ASTM A276/A276M, or ASTM A666 Type 316 stainless steel complying with ASTM A240/A240M, ASTM A276/A276M, or ASTM A666 steel complying with ASTM A36/A36M and hot-dip galvanized to comply with ASTM A123/A123M.
- b. Dowels: 1/2-inch- (12-mm-) diameter round bars, fabricated from Type 304 stainless steel complying with ASTM A240/A240M, ASTM A276/A276M, or ASTM A666 Type 316 stainless steel complying with ASTM A240/A240M, ASTM A276/A276M, or ASTM A666 steel complying with ASTM A36/A36M and hot-dip galvanized to comply with ASTM A123/A123M.
- c. Proprietary Acidic Cleaner: Manufacturer's standard-strength cleaner designed for removing mortar/grout stains, efflorescence, and other new construction stains from new masonry without discoloring or damaging masonry surfaces. Use product expressly approved for intended use by cast stone manufacturer and expressly approved by cleaner manufacturer for use on cast stone and adjacent masonry materials.

6. MORTAR MIXES

- a. Comply with requirements in Section "Unit Masonry" Section "Masonry Veneer" for mortar mixes.
- b. Do not use admixtures including pigments, air-entraining agents, accelerators, retarders, water-repellent agents, antifreeze compounds, or other admixtures unless otherwise indicated.
 - i Do not use calcium chloride in mortar or grout.
 - ii Use portland cement-lime masonry cement or mortar cement mortar unless otherwise indicated.
- c. Comply with ASTM C270, Proportion Specification.
 - i For setting mortar, use Type S Type N.
 - ii For pointing mortar, use Type N Type O.
- d. Preblended dry mortar mix complying with ASTM C1714/C1714M and capable of producing mortar strength as indicated in ASTM C270.
 - i For setting mortar, use Type S Type N.
 - ii For pointing mortar, use Type N Type O.
- e. Pigmented Mortar: Use colored cement product or select and proportion pigments with other ingredients to produce color required. Do not add pigments to colored cement products.
 - i Pigments do not exceed 5 percent of masonry cement or mortar cement by weight.
 - ii Mix to match Architect's sample.
 - iii Application: Use pigmented mortar for exposed mortar joints.
- f. Colored-Aggregate Mortar: Produce required mortar color by using colored aggregates and natural color or white cement as necessary to produce required mortar color.
 - i Mix to match Architect's sample.
 - ii Application: Use colored-aggregate mortar for exposed mortar joints.

7. SOURCE QUALITY CONTROL

- a. Engage a qualified independent testing agency to sample and test cast stone units according to ASTM C1364.

C.4 Construction - Cast Stone

1. EXAMINATION

- a. Examine substrates and conditions, with Installer present, for compliance with requirements for installation tolerances and other conditions affecting performance of the Work.
- b. Proceed with installation only after unsatisfactory conditions have been corrected.

2. SETTING CAST STONE IN MORTAR

- a. Set cast stone as indicated in TMS 604.
- b. Install cast stone units to comply with requirements in Section "Unit Masonry." Section "Masonry Veneer."
- c. Set cast stone as indicated on Drawings. Set units accurately in locations indicated, with edges and faces aligned according to established relationships and indicated tolerances.
 - i. Install anchors, supports, fasteners, and other attachments indicated or necessary to secure units in place.
 - ii. Coordinate installation of cast stone with installation of flashing specified in other Sections.
- d. Wet joint surfaces thoroughly before applying mortar or setting in mortar.
- e. Set units in full bed of mortar with full head joints unless otherwise indicated.
 - i. Set units with joints 1/4 to 3/8 inch (6 to 10 mm) 3/8 to 1/2 inch (10 to 13 mm) wide unless otherwise indicated.
 - ii. Build anchors and ties into mortar joints as units are set.
 - iii. Fill dowel holes and anchor slots with mortar.
 - iv. Fill collar joints solid as units are set.
 - v. Build concealed flashing into mortar joints as units are set.
 - vi. Keep head joints in copings and between other units with exposed horizontal surfaces open to receive sealant.
 - vii. Keep joints at shelf angles open to receive sealant.
- f. Rake out joints for pointing with mortar to depths of not less than 3/4 inch (19 mm). Rake joints to uniform depths with square bottoms and clean sides. Scrub faces of units to remove excess mortar as joints are raked.
- g. Point mortar joints by placing and compacting mortar in layers not greater than 3/8 inch (10 mm). Compact each layer thoroughly and allow it to become thumbprint hard before applying next layer.
- h. Tool exposed joints slightly concave when thumbprint hard. Use a smooth plastic jointer larger than joint thickness.
- i. Rake out joints for pointing with sealant to depths of not less than 3/4 inch (19 mm). Scrub faces of units to remove excess mortar as joints are raked.
- j. Point joints with sealant to comply with applicable requirements in Section 079200 "Joint Sealants."
 - i. Prime cast stone surfaces to receive sealant and install compressible backer rod in joints before applying sealant unless otherwise indicated.
- k. Provide sealant joints at head joints of copings and other horizontal surfaces; at expansion, control, and pressure-relieving joints; and at locations indicated.
 - i. Keep joints free of mortar and other rigid materials.
 - ii. Build in compressible foam-plastic joint fillers where indicated.

- iii Form joint of width indicated, but not less than 3/8 inch (10 mm) 1/2 inch (13 mm).
 - iv Prime cast stone surfaces to receive sealant and install compressible backer rod in joints before applying sealant unless otherwise indicated.
 - v Prepare and apply sealant of type and at locations indicated to comply with applicable requirements in Section "Joint Sealants."
3. SETTING ANCHORED CAST STONE WITH SEALANT-FILLED JOINTS
- a. Set cast stone as indicated in TMS 604.
 - b. Set cast stone as indicated on Drawings. Set units accurately in locations indicated, with edges and faces aligned according to established relationships and indicated tolerances.
 - i Install anchors, supports, fasteners, and other attachments indicated or necessary to secure units in place.
 - ii Shim and adjust anchors, supports, and accessories to set cast stone in locations indicated with uniform joints.
 - c. Keep cavities open where unfilled space is indicated between back of cast stone units and backup wall; do not fill cavities with mortar or grout.
 - d. Fill anchor holes with sealant.
 - i Where dowel holes occur at pressure-relieving joints, provide compressible material at ends of dowels.
 - e. Set cast stone supported on clip or continuous angles on resilient setting shims. Use material of thickness required to maintain uniform joint widths. Hold shims back from face of cast stone a distance at least equal to width of joint.
 - f. Keep joints free of mortar and other rigid materials. Remove temporary shims and spacers from joints after anchors and supports are secured in place and cast stone units are anchored. Do not begin sealant installation until temporary shims and spacers are removed.
 - i Form open joint of width indicated, but not less than 3/8 inch (10 mm) 1/2 inch (13 mm).
 - g. Prime cast stone surfaces to receive sealant and install compressible backer rod in joints before applying sealant unless otherwise indicated.
 - h. Prepare and apply sealant of type and at locations indicated to comply with applicable requirements in Section "Joint Sealants."
4. INSTALLATION TOLERANCES
- a. Variation from Plumb: Do not exceed 1/4 inch in 10 ft. (6 mm in 3 m)
 - b. Variation from Level: Do not exceed 1/4 inch in 10 ft. (6 mm in 3 m)
 - c. Variation in Joint Width: Do not vary joint thickness more than 1/8 inch in 36 inches (3 mm in 900 mm) or one-fourth of nominal joint width, whichever is less.
 - d. Variation in Plane between Adjacent Surfaces (Lipping): Do not vary from flush alignment with adjacent units or adjacent surfaces indicated to be flush with units by more than 1/16 inch (1.5 mm), except where variation is due to warpage of units within tolerances specified.
5. ADJUSTING AND CLEANING
- a. Remove and replace stained and otherwise damaged units and units not matching approved Samples. Cast stone may be repaired if methods and results are approved by Architect.
 - b. Replace units in a manner that results in cast stone matching approved Samples, complying with other requirements, and showing no evidence of replacement.

- c. In-Progress Cleaning: Clean cast stone as work progresses.
 - i Remove mortar fins and smears before tooling joints.
 - ii Remove excess sealant immediately, including spills, smears, and spatter.
- d. Final Cleaning: After mortar is thoroughly set and cured, clean exposed cast stone as follows:
 - i Remove large mortar particles by hand with wooden paddles and nonmetallic scrape hoes or chisels.
 - ii Test cleaning methods on sample; leave one sample uncleaned for comparison purposes. Obtain Architect's approval of sample cleaning before proceeding with cleaning of cast stone.
 - iii Protect adjacent surfaces from contact with cleaner by covering them with liquid strippable masking agent or polyethylene film and waterproof masking tape.
 - iv Wet surfaces with water before applying cleaners; remove cleaners promptly by rinsing thoroughly with clear water.
 - v Clean cast stone with proprietary acidic cleaner applied according to manufacturer's written instructions.

D Measurement

The department will measure Masonry and Cast Stone Work by the square foot, acceptably completed. The quantity to be paid for will be the sum of the areas of exposed faces at the locations shown on the plans. Area will be determined from measurements taken in the plane of the exposed face of the masonry and cast stone.

E Payment

The department will pay for measured quantities at the contract unit price under the following bid item:

ITEM NUMBER	DESCRIPTION	UNIT
SPV.0165.01	Masonry and Cast Stone Work	SF

Payment is full compensation for furnishing and installation of all masonry, cast stone in the project.

65. Steel Decking, Item SPV.0165.02.

A Description

Work under this item applies to the use of metal roof deck and composite floor deck.

B Materials

B.1 Delivery, Storage and Handling

Protect steel deck from corrosion, deformation, and other damage during delivery, storage, and handling. Stack steel deck on platforms or pallets and slope to provide drainage. Protect with a waterproof covering and ventilate to avoid condensation.

B.2 Submittals

B.2.1 Shop Drawings

Provide shop drawings and design calculations that are signed and sealed by a registered professional engineer licensed in the State of Wisconsin. Submit shop drawings to the engineer that include layout and types of deck panels, anchorage details, reinforcing channels, pans, cut deck openings, special jointing, accessories, and attachments to other construction.

Submit one copy of the shop drawings and design calculations to the engineer for review and acceptance before ordering material and starting construction. Show on the drawings the grade of steel, the physical and section properties for all deck form members and supporting elements, the method of support and

grade adjustment, length, size and spacing of welds and attachment methods, deflections, methods of end sealing against concrete or grout leaks, and the method for handling, storage and installation of the metal deck panels. Do not install metal deck forms until the forming system has been approved by the engineer. Review and acceptance of the installation plan by the department does not relieve the contractor of responsibility for properly designing and constructing the roof decks and composite floor decks with the use of metal deck forms.

B.2.2 Informational Submittals

- Welding certificates.
- Product certificates.
- Evaluation reports.
- Field quality-control reports.

B.3 Performance Requirements

Comply with calculated structural characteristics of steel deck according to AISI's "North American Specification for the Design of Cold-Formed Steel Structural Members."

B.4 Roof Deck

Subject to compliance with requirements, provide products manufactured by one of the following, or approved equal;

1. Canam United States; Canam Group Inc.
2. CMC Joist and Deck.
3. Nucor Corp.; Vulcraft Group.

Fabricate panels, without top-flange stiffening grooves, to comply with "ANSI/SDI SD-2022 Standard for Steel Deck", and with the following:

Prime-Painted Steel Sheet: ASTM A 1008/A 1008M, Structural Steel (SS), Grade 40 minimum, shop primed with manufacturer's standard baked-on, rust-inhibitive primer.

Color: Manufacturer's standard.

Galvanized-Steel Sheet: ASTM A 653/A 653M, Structural Steel (SS), Grade 40 zinc coating.

Galvanized and Shop-Primed Steel Sheet: ASTM A 653/A 653M, Structural Steel (SS), Grade 40 zinc coating; cleaned, pretreated, and primed with manufacturer's standard baked-on, rust-inhibitive primer.

Color: Manufacturer's standard.

Deck Profile: As shown on plans.

Profile Depth: As shown on plans.

Design Uncoated-Steel Thickness: Per supplier design.

Span Condition: Triple span or more whenever possible.

Side Laps: Overlapped or interlocking seam.

B.5 Composite Floor Deck

Manufacturers: Subject to compliance with requirements, provide products by one of the following, or approved equal:

1. Canam United States; Canam Group Inc.
2. CMC Joist and Deck.
3. Nucor Corp.; Vulcraft Group.

Fabricate panels, with integrally embossed or raised pattern ribs and interlocking side laps, to comply with "American National Standards Institute/Steel Deck Institute (ANSI/SDI) SD-2022 Standard for Steel Deck", with the minimum section properties indicated, and with the following:

Prime-Painted Steel Sheet: ASTM A 1008/A 1008M Structural Steel (SS), Grade 40 minimum, with top surface phosphatized and unpainted and underside surface shop primed with manufacturers' standard baked-on, rust-inhibitive primer.

Galvanized-Steel Sheet: ASTM A 653/A 653M Structural Steel (SS), Grade 33 (230), G30 (Z90), G60 (Z180) or G90 (Z275) zinc coating.

Galvanized and Shop-Primed Steel Sheet: ASTM A 653/A 653M, Structural Steel (SS), Grade 33 (230), G30 (Z90) or G60 (Z180) zinc coating; with unpainted top surface and cleaned and pretreated bottom surface primed with manufacturer's standard gray or white baked-on, rust-inhibitive primer.

Profile Depth: As shown on plans

Design Uncoated-Steel Thickness: Per supplier design.

Span Condition: Triple span or more whenever possible.

B.6 Accessories

- General: Provide manufacturer's standard accessory materials for deck that comply with requirements indicated.
- Mechanical Fasteners: Corrosion-resistant, low-velocity, powder-actuated or pneumatically driven carbon-steel fasteners; or self-drilling, self-threading screws.
- Side-Lap Fasteners: Corrosion-resistant, hexagonal washer head; self-drilling, carbon-steel screws, No. 10 minimum diameter
- Flexible Closure Strips: Vulcanized, closed-cell, synthetic rubber.
- Miscellaneous Sheet Metal Deck Accessories: Steel sheet, minimum yield strength of 33,000 psi, not less than 0.0359-inch design uncoated thickness, of same material and finish as deck; of profile indicated or required for application.

Pour Stops and Girder Fillers: Steel sheet, minimum yield strength of 33,000 psi, of same material and finish as deck, and of thickness and profile indicated.

Column Closures, End Closures, Z-Closures, and Cover Plates: Steel sheet, of same material, finish, and thickness as deck unless otherwise indicated.

Weld Washers: Uncoated steel sheet, shaped to fit deck rib, 0.0747 inch thick, with factory-punched hole of 3/8-inch minimum diameter.

Flat Sump Plates: Single-piece steel sheet, 0.0747 inch thick, of same material and finish as deck. For drains, cut holes in the field.

Recessed Sump Pans: Single-piece steel sheet, 0.0747 inch thick, of same material and finish as deck, with 3-inch-wide flanges and sloped recessed pans of 1-1/2-inch minimum depth. For drains, cut holes in the field.

Galvanizing Repair Paint: ASTM A 780, SSPC-Paint 20 or MIL-P-21035B, with dry film containing a minimum of 94 percent zinc dust by weight.

Repair Paint: Manufacturer's standard rust-inhibitive primer of same color as primer.

C Construction

C.1 Field Examination

Examine supporting frame and field conditions for compliance with requirements for installation tolerances and other conditions affecting performance.

Proceed with installation only after unsatisfactory conditions have been corrected.

C.2 Fracture Critical Members

For steel decking attached to structural steel truss chords identified as Fracture Critical Material (FCM) in the plan, welding directly to the member or use of powder actuated fasteners in the member will not be allowed. Provide an alternative means of attachment. Welding of shear studs (as shown in the plan) through the steel decking to the top of chord flanges as a means of attachment is acceptable.

C.3 General

Install deck panels and accessories according to applicable specifications and commentary in ANSI/SDI SD-2022 Standard for Steel Deck, manufacturer's written instructions, and requirements in this Section.

Place deck panels on supporting frame and adjust to final position with ends accurately aligned and bearing on supporting frame before being permanently fastened. Do not stretch or contract side-lap interlocks.

Place deck panels flat and square and fasten to supporting frame without warp or deflection.

Cut and neatly fit deck panels and accessories around openings and other work projecting through or adjacent to deck.

Provide additional reinforcement and closure pieces at openings as required for strength, continuity of deck, and support of other work.

Comply with AWS requirements and procedures for manual shielded metal arc welding, appearance and quality of welds, and methods used for correcting welding work.

Mechanical fasteners may be used in lieu of welding to fasten deck. Locate mechanical fasteners and install according to deck manufacturer's written instructions.

For all reinforcement, maintain the design concrete cover required by the plans. For reinforcement in the bottom of the deck, cover shall be measured from the top of the flutes.

Clean and recoat all damaged steel form panel galvanizing prior to placement of concrete. Repair damaged galvanizing using methods described in ASTM A780. Thoroughly clean, wire brush, and paint it with two coats of galvanizing compound to the satisfaction of the engineer. Do not touch up minor heat discoloration in areas of welds.

Vibrate concrete to avoid honeycomb and voids. The direction of concrete placement will be such that the upper layer of the form overlap is loaded first.

Do not use calcium chloride or any other admixture containing chloride salts in the concrete.

The seam between the angles / support and the beam should be caulked or grouted.

C.4 Welding Qualifications

Qualify procedures and personnel according to AWS D1.3, "Structural Welding Code - Sheet Steel."

C.5 Roof Deck Installation

Fasten roof-deck panels to steel supporting members by arc spot (puddle) welds of the surface diameter indicated or arc seam welds with an equal perimeter that is not less than 1-1/2 inches long, and as follows:

Weld Diameter: 3/4 inch, nominal.

Weld Spacing: Weld edge and interior ribs of deck units with a minimum of two welds per deck unit at each support. Space welds as indicated on drawings.

Weld Washers: Install weld washers at each weld location.

Side-Lap and Perimeter Edge Fastening: Fasten side laps and perimeter edges of panels between supports, at intervals not exceeding the lesser of 1/2 of the span or 12 inches, and as follows:

Fasten with a minimum of 1-1/2-inch- long welds.

End Bearing: Install deck ends over supporting frame with a minimum end bearing of 1-1/2 inches, with end joints as follows:

End Joints: Lapped 2 inches minimum.

Roof Sump Pans and Sump Plates: Install over openings provided in roof deck and weld or mechanically fasten flanges to top of deck. Space welds or mechanical fasteners not more than 12 inches apart with at least one weld or fastener at each corner. Install reinforcing channels or zees in ribs to span between supports and weld or mechanically fasten.

Miscellaneous Roof-Deck Accessories: Install ridge and valley plates, finish strips, end closures, and reinforcing channels according to deck manufacturer's written instructions. Weld or mechanically fasten to substrate to provide a complete deck installation. Weld cover plates at changes in direction of roof-deck panels unless otherwise indicated.

Flexible Closure Strips: Install flexible closure strips over partitions, walls, and where indicated. Install with adhesive according to manufacturer's written instructions to ensure complete closure.

C.6 Floor Deck Installation

Fasten floor-deck panels to steel supporting members by arc spot (puddle) welds of the surface diameter indicated and as follows:

Weld Diameter: 3/4 inch nominal.

Weld Spacing: Weld edge ribs of panels at each support. Space additional welds at 12 inches apart.

Weld Washers: Install weld washers at each weld location.

Side-Lap and Perimeter Edge Fastening: Fasten side laps and perimeter edges of panels between supports, at intervals not exceeding the lesser of half of the span or 36 inches, and as follows:

Fasten with a minimum of 1-1/2-inch long welds.

Fastening of floor deck by welding shear studs through the deck onto the beam below is an acceptable method of attachment.

End Bearing: Install deck ends over supporting frame with a minimum end bearing of 2" with end joints butted.

Pour Stops and Girder Fillers: Weld steel-sheet pour stops and girder fillers to supporting structure according to SDI recommendations unless otherwise indicated.

Floor-Deck Closures: Weld steel-sheet column closures, cell closures, and Z-closures to deck, according to SDI recommendations, to provide tight-fitting closures at open ends of ribs and sides of deck.

C.7 Field Quality Control

Contractor will engage a qualified testing agency to perform tests and inspections. Testing agency shall be qualified according to ASTM E 329 for testing indicated.

Qualify welding procedures and personnel according to AWS D1.3, "Structural Welding Code - Sheet Steel." Field welds will be subject to inspection.

FM Global Listing: Provide steel roof deck evaluated by FM Global and listed in its "Approval Guide, Building Materials" for Class 1 fire rating and Class 1-90 windstorm ratings.

Testing agency will report inspection results promptly and in writing to contractor and engineer.

Remove and replace work that does not comply with specified requirements.

Additional inspecting, at contractor's expense, will be performed to determine compliance of corrected work with specified requirements.

C.8 Repairs and Protection

Galvanizing Repairs: Prepare and repair damaged galvanized coatings on both surfaces of deck with galvanized repair paint according to ASTM A 780 and manufacturer's written instructions.

Repair Painting: Wire brush and clean rust spots, welds, and abraded areas on both surfaces of prime-painted deck immediately after installation and apply repair paint.

Provide final protection and maintain conditions to ensure that steel deck is without damage or deterioration at time of Substantial Completion.

D Measurement

The department will measure Steel Decking by the square foot, acceptably completed.

E Payment

The department will pay for measured quantities at the contract unit price under the following bid item:

ITEM NUMBER	DESCRIPTION	UNIT
SPV.0165.02	Steel Decking	SF

Payment is full compensation for supplying a design and shop drawings; and fabricating, providing and installing steel roof deck and steel composite floor decking.

66. Aluminum and Glass Curtain Walls, Item SPV.0165.03

A Description

1. SECTION INCLUDES:
 - a. Glazed aluminum curtain wall systems:
 - i Conventionally glazed.
 - ii Two-sided, structural-sealant-glazed.
 - iii Aluminum-framed entrance door systems.
 - iv Laminated and insulated glass.
 - v Glazing sealants.
 - vi Glazing tapes.
 - vii Miscellaneous glazing materials.
2. PREINSTALLATION MEETINGS
 - a. Preinstallation Conference: Conduct conference at Project site
3. ACTION SUBMITTALS
 - a. Product Data: For each type of product.
 - i Include construction details, material descriptions, dimensions of individual components and profiles, and finishes.
 - b. Sustainable Design Submittals:
 - c. Shop Drawings: For glazed aluminum curtain walls and entrances. Include plans, elevations, sections, full-size details, and attachments to other work.
 - i Include details of provisions for assembly expansion and contraction and for draining moisture occurring within the assembly to the exterior.
 - ii Include full-size isometric details of each type of vertical-to-horizontal intersection of glazed aluminum curtain walls, showing the following:
 - 1) Joinery, including concealed welds.
 - 2) Anchorage.
 - 3) Expansion provisions.
 - 4) Glazing.
 - 5) Flashing and drainage.
 - iii Show connection to and continuity with adjacent thermal, weather, air, and vapor barriers.
 - d. Samples for Initial Selection: For units with factory-applied color finishes.

- e. Samples for Verification: For each type of exposed finish required, in manufacturer's standard sizes.
- f. Fabrication Sample: Of each vertical-to-horizontal intersection of assemblies, made from 12-inch (300-mm) lengths of full-size components and showing details of the following:
 - i Joinery, including concealed welds.
 - ii Anchorage.
 - iii Expansion provisions.
 - iv Glazing.
 - v Flashing and drainage.
- g. Delegated-Design Submittal: For glazed aluminum curtain walls, including analysis data signed and sealed by the qualified professional engineer responsible for their preparation.

4. INFORMATIONAL SUBMITTALS

- a. Mockup Testing Submittals:
 - i Testing Program: Developed specifically for Project.
 - ii Test Reports: Prepared by a qualified preconstruction testing agency for each mockup test.
 - iii Record Drawings: As-built drawings of preconstruction laboratory mockups showing changes made during preconstruction laboratory mockup testing.
- b. Qualification Data:
 - i For Installer and laboratory mockup testing agency and field testing agency.
 - ii For professional engineer's experience with providing delegated-design engineering services of the kind indicated, including documentation that engineer is licensed in the jurisdiction state in which Project is located.
- c. Energy Performance Certificates: For glazed aluminum curtain walls, accessories, and components from manufacturer.
 - i Basis for Certification: NFRC-certified energy performance values for each glazed aluminum curtain wall.
- d. Product Test Reports: For glazed aluminum curtain walls, for tests performed by manufacturer and witnessed by a qualified testing agency.
- e. Quality-Control Program: Developed specifically for Project, including fabrication and installation, according to recommendations in ASTM C1401. Include periodic quality-control reports.
- f. Source quality-control reports.
- g. Field quality-control reports.
- h. Sample Warranties: For special warranties.

5. CLOSEOUT SUBMITTALS

- a. Maintenance Data: For glazed aluminum curtain walls to include in maintenance manuals.
- b. Maintenance Data for Structural Sealant: For structural-sealant-glazed curtain walls to include in maintenance manuals. Include ASTM C1401 recommendations for post-installation-phase quality-control program.

6. QUALITY ASSURANCE

- a. Installer Qualifications: An entity that employs installers and supervisors who are trained and approved by manufacturer and that employs a qualified glazing contractor for this Project who is certified under the North American Contractor Certification Program (NACC) for Architectural Glass & Metal (AGM) contractors and that employs glazing technicians certified under the Architectural Glass and Metal Technician (AGMT) certification program.
- b. Laboratory Mockup Testing Agency Qualifications: Qualified according to ASTM E699 for testing indicated and accredited by IAS or ILAC Mutual Recognition Arrangement as complying with ISO/IEC 17025.
- c. Testing Agency Qualifications: Qualified according to ASTM E699 for testing indicated and accredited by IAS or ILAC Mutual Recognition Arrangement as complying with ISO/IEC 17025 and acceptable to Owner and Architect.
- d. Product Options: Information on Drawings and in Specifications establishes requirements for aesthetic effects and performance characteristics of assemblies. Aesthetic effects are indicated by dimensions, arrangements, alignment, and profiles of components and assemblies as they relate to sightlines, to one another, and to adjoining construction.
 - i Do not change intended aesthetic effects, as judged solely by Architect, except with Architect's approval. If changes are proposed, submit comprehensive explanatory data to Architect for review.
- e. Structural-Sealant Glazing: Comply with ASTM C1401 for design and installation of structural-sealant-glazed curtain wall assemblies.

7. MOCKUPS

- a. Build mockups to verify selections made under Sample submittals and to demonstrate aesthetic effects and set quality standards for fabrication and installation.
 - i Build mockup of typical wall area as shown on Drawings.
 - ii Testing shall be performed on mockups according to requirements in "Field Quality Control" Article.
 - iii Approval of mockups does not constitute approval of deviations from the Contract Documents contained in mockups unless Architect specifically approves such deviations in writing.
 - iv Subject to compliance with requirements, approved mockups may become part of the completed Work if undisturbed at time of Substantial Completion.

8. PRECONSTRUCTION TESTING

- a. Preconstruction Testing Service: Owner will engage Engage a qualified testing agency to perform preconstruction testing on laboratory mockups.
 - i Build preconstruction laboratory mockups at testing agency facility; use personnel, products, and methods of construction that will be used at Project site.
 - ii Size and Configuration: As indicated on Drawings.
 - iii Notify Architect seven days in advance of the dates and times when preconstruction laboratory mockups will be constructed and tested.
- b. Preconstruction Laboratory Mockup Testing: Test preconstruction laboratory mockups according to requirements in "Performance Requirements" Article. Perform the following tests in the following order:
 - i Structural, 50 percent: ASTM E330/E330M at 50 percent of positive test load.
 - ii Air Leakage: ASTM E283.
 - iii Water Penetration under Static Pressure: ASTM E331.
 - iv Water Penetration under Dynamic Pressure: AAMA 501.1.

- v Interstory Drift, 100 percent: AAMA 501.4 at 100 percent of design displacement. Repeat the following:
- vi Air Leakage: ASTM E283.
- vii Water Penetration under Static Pressure: ASTM E331.
- viii Vertical Interstory Movement: AAMA 501.7 at 100 percent of design displacement. Repeat the following:
 - 1) Air Leakage: ASTM E283.
 - 2) Water Penetration under Static Pressure: ASTM E331.
- ix Thermal Cycling: AAMA 501.5. Repeat the following:
- x Air Leakage: ASTM E283.
- xi Water Penetration under Static Pressure: ASTM E331.
- xii Structural, 100 percent: ASTM E330/E330M at 100 percent of positive and negative test loads. Repeat the following:
 - 1) Air Leakage: ASTM E283.
 - 2) Water Penetration under Static Pressure: ASTM E331.
 - 3) Water Penetration under Dynamic Pressure: AAMA 501.1.
- xiii Structural, 150 percent: ASTM E330/E330M at 150 percent of positive and negative test loads.
- xiv Interstory Drift, 150 percent: AAMA 501.4 at 150 percent of design displacement.
- c. Preconstruction Adhesion and Compatibility Testing: Submit to structural glazing sealant manufacturer, for testing indicated below, Samples of each glazing material type, tape sealant, gasket, glazing accessory, and glass-framing member that is in close proximity to or is touching the structural or nonstructural sealants of a structural glazed system.
 - i Compatibility: Test materials or components using ASTM C1087.
 - ii Adhesion: Test for adhesion or lack of adhesion of a structural sealant to the surface of another material or component using ASTM C1135.
 - iii Submit no fewer than eight pieces of each type of material, including joint substrates, shims, joint-sealant backings, secondary seals, and miscellaneous materials.
 - iv Schedule sufficient time for testing and analyzing results to prevent delaying the Work.
 - v For materials failing tests, obtain sealant manufacturer's written instructions for corrective measures, including the use of specially formulated primers.
 - vi Testing will not be required if data based on previous testing of current sealant products match those submitted.

9. WARRANTY

- a. Special Assembly Warranty: Manufacturer agrees to repair or replace components of glazed aluminum curtain wall that do not comply with requirements or that fail in materials or workmanship within specified warranty period.
 - i Failures include, but are not limited to, the following:
 - 1) Structural failures including, but not limited to, excessive deflection.
 - 2) Noise or vibration created by wind and thermal and structural movements.
 - 3) Deterioration of metals, metal finishes, and other materials beyond normal weathering.
 - 4) Water penetration through fixed glazing and framing areas.
 - 5) Failure of operating components.

- ii Warranty Period: 10 years from date of Substantial Completion.
- b. Special Finish Warranty, Factory-Applied Finishes: Standard form in which manufacturer agrees to repair finishes or replace aluminum that shows evidence of deterioration of baked enamel, powder coat, or organic finishes within specified warranty period.
 - i Deterioration includes, but is not limited to, the following:
 - 1) Color fading more than 5 Delta E units when tested according to ASTM D2244.
 - 2) Chalking in excess of a No. 8 rating when tested according to ASTM D4214.
 - 3) Cracking, checking, peeling, or failure of paint to adhere to bare metal.
 - ii Warranty Period: 10 years from date of Substantial Completion.
- c. Special Finish Warranty, Anodized Finishes: Standard form in which manufacturer agrees to repair finishes or replace aluminum that shows evidence of deterioration of anodized finishes within specified warranty period.
 - i Deterioration includes, but is not limited to, the following:
 - 1) Color fading more than 5 Delta E units when tested according to ASTM D2244.
 - 2) Chalking in excess of a No. 8 rating when tested according to ASTM D4214.
 - 3) Cracking, peeling, or chipping.
 - ii Warranty Period: 10 years from date of Substantial Completion.

B Materials

B.1 PERFORMANCE REQUIREMENTS

1. Delegated Design: Engage a qualified professional engineer, as defined in "Quality Requirements," to design glazed aluminum curtain walls.
2. General Performance: Comply with performance requirements specified, as determined by testing of glazed aluminum curtain walls representing those indicated for this Project without failure due to defective manufacture, fabrication, installation, or other defects in construction.
 - a. Glazed aluminum curtain walls shall withstand movements of supporting structure, including, but not limited to, story drift, twist, column shortening, long-term creep, and deflection from uniformly distributed and concentrated live loads.
 - b. Failure also includes the following:
 - i Thermal stresses transferring to building structure.
 - ii Glass breakage.
 - iii Noise or vibration created by wind and thermal and structural movements.
 - iv Loosening or weakening of fasteners, attachments, and other components.
 - v Failure of operating units.
3. Structural Loads:
 - a. Wind Loads: As indicated on Drawings.
 - b. Other Design Loads: As indicated on Drawings
4. Deflection of Framing Members Supporting Glass: At design wind load, as follows:
 - a. Deflection Normal to Wall Plane: Limited to 1/175 of clear span for spans of up to 13 feet 6 inches (4.1 m) and to 1/240 of clear span plus 1/4 inch (6.35 mm) for spans of greater than 13 feet 6 inches (4.1 m).

- b. Deflection Parallel to Glazing Plane: Limited to amount not exceeding that which reduces glazing bite to less than 75 percent of design dimension and that which reduces edge clearance between framing members and glazing or other fixed components to less than 1/8 inch (3.2 mm).
 - i Operable Units: Provide a minimum 1/16-inch (1.6-mm) clearance between framing members and operable units.
 - c. Cantilever Deflection: Limited to 2l/175 at unsupported cantilevers.
5. Structural: Test according to ASTM E330/E330M as follows:
- a. When tested at positive and negative wind-load design pressures, assemblies do not evidence deflection exceeding specified limits.
 - b. When tested at 150 percent of positive and negative wind-load design pressures, assemblies, including anchorage, do not evidence material failures, structural distress, or permanent deformation of main framing members exceeding 0.2 percent of span.
 - c. Test Durations: As required by design wind velocity, but not less than 10 seconds.
6. Water Penetration under Static Pressure: Test according to ASTM E331 as follows:
- a. No evidence of water penetration through fixed glazing and framing areas when tested according to a minimum static-air-pressure differential of 20 percent of positive wind-load design pressure, but not less than 6.24 lbf/sq. ft. (300 Pa) 10 lbf/sq. ft. (480 Pa) 15 lbf/sq. ft. (720 Pa).
7. Water Penetration under Dynamic Pressure: Test according to AAMA 501.1 as follows:
- a. No evidence of water penetration through fixed glazing and framing areas when tested at dynamic pressure equal to 20 percent of positive wind-load design pressure, but not less than 6.24 lbf/sq. ft. (300 Pa) 10 lbf/sq. ft. (480 Pa) 15 lbf/sq. ft. (720 Pa).
 - b. Maximum Water Leakage: According to AAMA 501.1 No uncontrolled water penetrating assemblies or water appearing on assemblies' normally exposed interior surfaces from sources other than condensation. Water leakage does not include water controlled by flashing and gutters or water that is drained to exterior.
8. Interstory Drift: Accommodate design displacement of adjacent stories indicated.
- a. Design Displacement: As indicated on Drawings .
 - b. Test Performance: Complying with criteria for passing based on building occupancy type when tested according to AAMA 501.4 at design displacement and 1.5 times the design displacement.
9. Seismic Performance: Glazed aluminum curtain walls shall withstand the effects of earthquake motions determined according to ASCE/SEI 7.
- a. Seismic Drift Causing Glass Fallout: Complying with criteria for passing based on building occupancy type when tested according to AAMA 501.6 at design displacement and 1.5 times the design displacement.
 - b. Vertical Interstory Movement: Complying with criteria for passing based on building occupancy type when tested according to AAMA 501.7 at design displacement and 1.5 times the design displacement.
10. Energy Performance: Certified and labelled by manufacturer for energy performance as follows:
- a. Thermal Transmittance (U-factor):
 - i Fixed Glazing and Framing Areas: U-factor for the system of not more than 0.29 Btu/sq. ft. x h x deg F (1.65 W/sq. m x K) 0.36 Btu/sq. ft. x h x deg F (2.04 W/sq. m x K) 0.38 Btu/sq. ft. x h x deg F (2.16 W/sq. m x K) 0.41 Btu/sq. ft. x h x deg F (2.33 W/sq. m x K) 0.46 Btu/sq. ft. x h x deg F (2.61 W/sq. m x K) 0.50 Btu/sq. ft. x h x deg F (2.84 W/sq. m x K) as determined according to NFRC 100.

- ii Venting Windows: Whole window U-factor of not more than 0.37 Btu/sq. ft. x h x deg F (2.10 W/sq. m x K) 0.43 Btu/sq. ft. x h x deg F (2.44 W/sq. m x K) 0.45 Btu/sq. ft. x h x deg F (2.55 W/sq. m x K) 0.60 Btu/sq. ft. x h x deg F (3.40 W/sq. m x K) 0.65 Btu/sq. ft. x h x deg F (3.69 W/sq. m x K) as determined according to NFRC 100.
 - b. Solar Heat Gain Coefficient (SHGC):
 - i Fixed Glazing and Framing Areas: SHGC for the system of not more than 0.22 0.25 0.26 0.29 0.40 0.45 as determined according to NFRC 200.
 - ii Venting Windows: Whole-window SHGC of not more than 0.22 0.27 0.30 0.40 as determined according to NFRC 200.
 - c. Air Leakage:
 - i Fixed Glazing and Framing Areas: Air leakage for the system of not more than 0.06 cfm/sq. ft. (0.30 L/s per sq. m) at a static-air-pressure differential of 1.57 lbf/sq. ft. (75 Pa) 6.24 lbf/sq. ft. (300 Pa) when tested according to ASTM E283.
 - ii Venting Windows: Whole-window air leakage of not more than 0.3 cfm/sq. ft. (0.30 L/s per sq. m) at a static-air-pressure differential of 6.24 lbf/sq. ft. (300 Pa) when tested according to AAMA/WDMA/CSA 101/I.S.2/A440.
 - d. Condensation Resistance Factor (CRF):
 - i Fixed Glazing and Framing Areas: CRF for the system of not less than 29 55 65 80 as determined according to AAMA 1503.
 - ii Venting Windows: Whole-window CRF of not less than 45 52 55 as determined according to AAMA 1503.
11. Noise Reduction: Test according to ASTM E90, with ratings determined by ASTM E1332, as follows:
- a. Outdoor-Indoor Transmission Class: Minimum 34.
 - b. Sound Transmission Class: Minimum 40.
12. Blast Resistance:
- a. Hazard Rating: Moderate Hazard according to ASTM F2912, tested according to ASTM F1642/F1642M.
 - b. Performance Condition: 1 2 3a 3b 4 5 according to GSA-TS01.
13. Windborne-Debris Impact Resistance: Pass ASTM E1886 missile-impact and cyclic-pressure tests according to ASTM E1996 for Wind Zone 1 for enhanced protection.
- a. Large-Missile Test: For glazing located within 30 feet (9.1 m) of grade.
 - b. Small-Missile Test: For glazing located between 30 feet (9.1 m) and 60 feet (18.2 m) above grade.
14. Thermal Movements: Allow for thermal movements resulting from ambient and surface temperature changes:
- a. Temperature Change: 120 deg F (67 deg C), ambient; 180 deg F (100 deg C), material surfaces.
 - b. Thermal Cycling: No buckling; stress on glass; sealant failure; excess stress on framing, anchors, and fasteners; or reduction of performance when tested according to AAMA 501.5.
 - i High Exterior Ambient-Air Temperature: That which produces an exterior metal-surface temperature of 180 deg F (82 deg C).
 - ii Low Exterior Ambient-Air Temperature: 0 deg F (minus 18 deg C).
15. Structural-Sealant Joints:
- a. Designed to carry gravity loads of glazing.

16. Structural Sealant: ASTM C1184. Capable of withstanding tensile and shear stresses imposed by structural-sealant-glazed curtain walls without failing adhesively or cohesively. When tested for preconstruction adhesion and compatibility, cohesive failure of sealant shall occur before adhesive failure.
 - a. Adhesive failure occurs when sealant pulls away from substrate cleanly, leaving no sealant material behind.
 - b. Cohesive failure occurs when sealant breaks or tears within itself but does not separate from each substrate, because sealant-to-substrate bond strength exceeds sealant's internal strength.

B.2 SOURCE LIMITATIONS

1. Obtain all components of curtain-wall system and storefront system, including framing spandrel panels venting windows entrances sun control and accessories, from single manufacturer.

B.3 GLAZED ALUMINUM CURTAIN WALL SYSTEMS

1. Manufacturers: Kawneer Inc System 1620 UT SSG (base of design), Oldcastle or approved equal
2. Framing Members: Manufacturer's extruded- or formed-aluminum framing members of thickness required and reinforced as required to support imposed loads.
 - a. Construction: Thermally broken.
 - b. Glazing System: Retained mechanically with gaskets on four sides Retained mechanically with gaskets on two sides and structural sealant on two sides.
 - c. Glazing Plane: Front.
 - d. Finish: Clear anodic finish Color anodic finish Baked-enamel or powder-coat finish High-performance organic finish Superior-performance organic finish.
 - e. System: Either stick or unitized system Stick system Unitized system.
 - f. Aluminum: Alloy and temper recommended by manufacturer for type of use and finish indicated.
 - g. Steel Reinforcement: As required by manufacturer.
3. Pressure Caps: Manufacturer's standard aluminum components that mechanically retain glazing.
 - a. Include snap-on aluminum trim that conceals fasteners.
4. Brackets and Reinforcements: Manufacturer's standard high-strength aluminum with nonstaining, nonferrous shims for aligning system components.
5. Insulated Spandrel Panels:
 - a. Comply with Section "Insulated Metal Wall Panels."
 - b. Laminated, metal-faced flat panels with no deviations in plane exceeding 0.8 percent of panel dimension in width or length.
 - i Overall Panel Thickness: As indicated 1 inch (25.4 mm).
 - ii Exterior Skin: Aluminum.
 - Thickness: Manufacturer's standard for finish and texture indicated.
 - Finish: Match framing system.
 - Texture: Smooth Embossed.
 - Backing Sheet: 1/8-inch- (3.2-mm-) thick, tempered hardboard 0.157-inch- (4-mm-) thick, cement board 0.125-inch- (3.2-mm-) thick, corrugated, high-density polyethylene.

- iii Interior Skin: Aluminum Manufacturer's standard galvanized-steel sheet.
 - Thickness: Manufacturer's standard for finish and texture indicated.
 - Finish: Matching curtain-wall framing Low-gloss, white baked enamel Mill finish.
 - Texture: Smooth Embossed.
 - Backing Sheet: 1/8-inch- (3.2-mm-) thick, tempered hardboard 0.157-inch- (4-mm-) thick, cement board 1/2-inch- (12.7-mm-) thick, gypsum board with proprietary fire-resistance-rated core 0.125-inch- (3.2-mm-) thick, corrugated, high-density polyethylene.
 - iv Thermal Insulation Core: Manufacturer's standard rigid, closed-cell, polyisocyanurate board extruded-polystyrene board expanded-perlite, mineral-insulation board .
 - v Surface-Burning Characteristics: Comply with ASTM E84; testing by a qualified testing agency. Identify products with appropriate markings of applicable testing agency.
 - Flame-Spread Index: 25 or less.
 - Smoke-Developed Index: 50 450 or less.
6. Entrance Door Systems: Comply with Section "Aluminum-Framed Entrances and Storefronts" Section "Aluminum-Framed Entrances".

B.4 GLAZING

1. Glazing: Comply with Section "Glazing."
2. Glazing Gaskets: ASTM C509 or ASTM C864. Manufacturer's standard Compression-type, replaceable EPDM Extruded silicone Comply with Section "Glazing." .
 - a. Color: Black.
3. Glazing Sealants: As recommended by manufacturer. Comply with Section "Glazing."
4. Structural Glazing Sealants: ASTM C1184, chemically curing silicone formulation that is compatible with system components with which it comes into contact, specifically formulated and tested for use as structural sealant and approved by structural-sealant manufacturer for use in curtain-wall assembly indicated.
 - a. Color: Black Gray As selected by Architect from manufacturer's full range of colors.
5. Weatherseal Sealants: ASTM C920 for Type S; Grade NS; Class 25; Uses NT, G, A, and O; chemically curing silicone formulation that is compatible with structural sealant and other system components with which it comes into contact; recommended by structural-sealant, weatherseal-sealant, and structural-sealant-glazed curtain-wall manufacturers for this use.
 - a. Color: Match structural sealant.

B.5 MATERIAL STANDARDS

1. Sheet and Plate: ASTM B209 (ASTM B209M).
2. Extruded Bars, Rods, Profiles, and Tubes: ASTM B221 (ASTM B221M).
3. Structural Profiles: ASTM B308/B308M.
4. Steel Reinforcement:
 - a. Structural Shapes, Plates, and Bars: ASTM A36/A36M.
 - b. Cold-Rolled Sheet and Strip: ASTM A1008/A1008M.
 - c. Hot-Rolled Sheet and Strip: ASTM A1011/A1011M.
5. Steel Reinforcement Primer: Manufacturer's standard zinc-rich, corrosion-resistant primer complying with SSPC-PS Guide No. 12.00; applied immediately after surface preparation and pretreatment. Select surface preparation methods according to recommendations in SSPC-SP COM, and prepare surfaces according to applicable SSPC standard.

B.6 ACCESSORIES

1. Fasteners and Accessories: Manufacturer's standard corrosion-resistant, nonstaining, nonbleeding fasteners and accessories compatible with adjacent materials.
 - a. Use self-locking devices where fasteners are subject to loosening or turning out from thermal and structural movements, wind loads, or vibration.
 - b. Reinforce members as required to receive fastener threads.
 - c. Use exposed fasteners with countersunk Phillips screw heads, finished to match framing system, fabricated from 300 series stainless steel.
2. Anchors: Three-way adjustable anchors with minimum adjustment of 1 inch (25.4 mm) that accommodate fabrication and installation tolerances in material and finish compatible with adjoining materials and recommended by manufacturer.
 - a. Concrete and Masonry Inserts: Hot-dip galvanized cast-iron, malleable-iron, or steel inserts complying with ASTM A123/A123M or ASTM A153/A153M requirements.
3. Concealed Flashing: Manufacturer's standard corrosion-resistant, nonstaining, nonbleeding flashing compatible with adjacent materials Dead-soft, 0.018-inch- (0.457-mm-) thick stainless steel, ASTM A240/A240M of type recommended by manufacturer.
4. Bituminous Paint: Cold-applied asphalt-mastic paint containing no asbestos, formulated for 30-mil (0.762-mm) thickness per coat.

B.7 FABRICATION

1. Form or extrude aluminum shapes before finishing.
2. Weld in concealed locations to greatest extent possible to minimize distortion or discoloration of finish. Remove weld spatter and welding oxides from exposed surfaces by descaling or grinding.
3. Fabricate components that, when assembled, have the following characteristics:
 - a. Profiles that are sharp, straight, and free of defects or deformations.
 - b. Accurately fitted joints with ends coped or mitered.
 - c. Physical and thermal isolation of glazing from framing members.
 - d. Accommodations for thermal and mechanical movements of glazing and framing to maintain required glazing edge clearances.
 - e. Provisions for field replacement of glazing from exterior interior interior for vision glass and exterior for spandrel glazing or metal panels.
 - f. Provisions for safety railings mounted on interior face of mullions between mullions at interior.
 - g. Fasteners, anchors, and connection devices that are concealed from view to greatest extent possible.
 - h. Components curved to indicated radii.
4. Fabricate components to resist water penetration as follows:
 - a. Internal guttering system or other means to drain water passing joints, condensation occurring within framing members, and moisture migrating within glazed aluminum curtain wall to exterior.
 - b. Pressure-equalized system or double barrier design with primary air and vapor barrier at interior side of glazed aluminum curtain wall and secondary seal weeped and vented to exterior.
5. Curtain-Wall Framing: Fabricate components for assembly using manufacturer's standard assembly method shear-block system screw-spline system head-and-sill-receptor system with shear blocks at intermediate horizontal members.

6. Factory-Assembled Frame Units:
 - a. Rigidly secure nonmovement joints.
 - b. Prepare surfaces that are in contact with structural sealant according to sealant manufacturer's written instructions, to ensure compatibility and adhesion. Preparation includes, but is not limited to, cleaning and priming surfaces.
 - c. Seal joints watertight unless otherwise indicated.
 - d. Install glazing to comply with requirements in Section "Glazing."
 - e. Install structural glazing.
 - i. Set glazing into framing according to sealant manufacturer and framing manufacturer's written instructions and standard practice. Use a spacer or backer as recommended by manufacturer.
 - ii. Set glazing with proper orientation so that coatings face exterior or interior as specified.
 - iii. Apply structural silicone sealant to completely fill cavity, according to sealant manufacturer's written instructions with the framing and glazing in a fully supported position.
 - iv. Brace or stiffen framing and glazing in such a manner to prevent undue stresses on the glass edge seal and structural joints or movement of the glazing, until sealant is fully cured according to manufacturer's recommendations.
 - v. After structural sealant has completely cured, insert backer rod between lites of glass as recommended by sealant manufacturer.
 - vi. Install weatherseal sealant to completely fill cavity, according to sealant manufacturer's written instructions, to produce weatherproof joints.
 - vii. Clean and protect glass as indicated in Section "Glazing."
 - viii. Retain bracing or stiffening until erected to prevent racking of units during transportation and erection.
7. After fabrication, clearly mark components to identify their locations in Project according to Shop Drawings.

B.8 ALUMINUM FINISHES

1. Clear Anodic Finish: AAMA 611, AA-M12C22A41, Class I, 0.018 mm AA-M12C22A31, Class II, 0.010 mm or thicker.
2. Color Anodic Finish: AAMA 611, AA-M12C22A42/A44, Class I, 0.018 mm AA-M12C22A32/A34, Class II, 0.010 mm or thicker.
 - a. Color: As selected by Architect from full range of industry colors and color densities >.
3. Baked-Enamel or Powder-Coat Finish: AAMA 2603. Comply with coating manufacturer's written instructions for cleaning, conversion coating, and applying and baking finish.
 - a. Color and Gloss: As indicated by manufacturer's designations Match Architect's sample As selected by Architect from manufacturer's full range .

B.9 SOURCE QUALITY CONTROL

1. Structural Sealant: Perform quality-control procedures complying with ASTM C1401 recommendations, including, but not limited to, assembly material qualification procedures, sealant testing, and assembly fabrication reviews and checks.

C Construction

C.1 EXAMINATION

1. Examine areas, with Installer present, for compliance with requirements for installation tolerances and other conditions affecting performance of the Work.
2. Proceed with installation only after unsatisfactory conditions have been corrected.

C.2 INSTALLATION, GENERAL

1. Comply with manufacturer's written instructions.
2. Do not install damaged components.
3. Fit joints to produce hairline joints free of burrs and distortion.
4. Rigidly secure nonmovement joints.
5. Install anchors with separators and isolators to prevent metal corrosion and electrolytic deterioration and to prevent impeding movement of moving joints.
6. Where welding is required, weld components in concealed locations to minimize distortion or discoloration of finish. Protect glazing surfaces from welding.
7. Seal joints watertight unless otherwise indicated.
8. Metal Protection:
 - a. Where aluminum is in contact with dissimilar metals, protect against galvanic action by painting contact surfaces with primer, applying sealant or tape, or installing nonconductive spacers as recommended by manufacturer for this purpose.
 - b. Where aluminum is in contact with concrete or masonry, protect against corrosion by painting contact surfaces with bituminous paint.
9. Install components to drain water passing joints, condensation occurring within framing members, and moisture migrating within glazed aluminum curtain wall to exterior.
10. Install components plumb and true in alignment with established lines and grades.

C.3 INSTALLATION OF OPERABLE UNITS

1. Install operable units level and plumb, securely anchored, and without distortion. Adjust weather-stripping contact and hardware movement to produce proper operation.

C.4 INSTALLATION OF GLAZING

1. Install glazing as specified in "Glazing."

C.5 INSTALLATION OF STRUCTURAL GLAZING

1. Prepare surfaces that will contact structural sealant according to sealant manufacturer's written instructions, to ensure compatibility and adhesion. Preparation includes, but is not limited to, cleaning and priming surfaces.
2. Set glazing into framing according to sealant manufacturer's and framing manufacturer's written instructions and standard practice. Use a spacer or backer as recommended by manufacturer.
3. Set glazing with proper orientation, so that coatings face exterior or interior as specified.
4. Hold glazing in place using temporary retainers of type and spacing recommended by manufacturer, until structural sealant joint has cured.
5. Apply structural sealant to completely fill cavity, according to sealant manufacturer's and framing manufacturer's written instructions and in compliance with local codes.
6. Apply structural sealant at temperatures indicated by sealant manufacturer for type of sealant.
7. Allow structural sealant to cure according to manufacturer's recommendations.
8. Clean and protect glass as indicated in "Glazing."

C.6 INSTALLATION OF WEATHERSEAL SEALANT

1. After structural sealant has completely cured, remove temporary retainers and insert backer rod between lites of glass, as recommended by sealant manufacturer.
2. Install weatherseal sealant to completely fill cavity, according to sealant manufacturer's written instructions, to produce weatherproof joints.

C.7 ERECTION TOLERANCES

1. Install glazed aluminum curtain walls to comply with the following maximum tolerances:
 - a. Plumb: 1/8 inch in 10 feet (3.2 mm in 3 m); 1/4 inch in 40 feet (6.35 mm in 12.2 m).
 - b. Level: 1/8 inch in 20 feet (3.2 mm in 6 m); 1/4 inch in 40 feet (6.35 mm in 12.2 m).
 - c. Alignment:
 - i Where surfaces abut in line or are separated by reveal or protruding element up to 1/2 inch (12.7 mm) wide, limit offset from true alignment to 1/16 inch (1.6 mm).
 - ii Where surfaces are separated by reveal or protruding element from 1/2 to 1 inch (12.7 to 25.4 mm) wide, limit offset from true alignment to 1/8 inch (3.2 mm).
 - iii Where surfaces are separated by reveal or protruding element of 1 inch (25.4 mm) wide or more, limit offset from true alignment to 1/4 inch (6 mm).
 - d. Location: Limit variation from plane to 1/8 inch in 12 feet (3.2 mm in 3.6 m); 1/2 inch (12.7 mm) over total length.

C.8 FIELD QUALITY CONTROL

1. TESTING AGENCY: OWNER WILL ENGAGE A QUALIFIED TESTING AGENCY TO PERFORM TESTS AND INSPECTIONS.
2. TEST AREA: PERFORM TESTS ON ONE BAY AT LEAST 30 FEET (9.1 M), BY ONE STORY REPRESENTATIVE AREAS OF GLAZED ALUMINUM CURTAIN WALLS MOCKUPS.
3. FIELD QUALITY-CONTROL TESTING: PERFORM THE FOLLOWING TEST ON REPRESENTATIVE AREAS OF GLAZED ALUMINUM CURTAIN WALLS MOCKUPS.
 - a. Water-Spray Test: Before installation of interior finishes has begun, areas designated by Architect shall be tested according to AAMA 501.2 and shall not evidence water penetration.
 - i Perform a minimum of two three tests in areas as directed by Architect.
 - ii Perform tests in each test area as directed by Architect. Perform at least three tests, prior to 35, and 70 percent completion .
 - b. Air Leakage: ASTM E783 at 1.5 times the rate specified for laboratory testing in "Performance Requirements" Article but not more than 0.09 cfm/sq. ft. (0.45 L/s per sq. m) at a static-air-pressure differential of 1.57 lbf/sq. ft. (75 Pa).
 - i Perform a minimum of two tests in areas as directed by Architect.
 - ii Perform tests in each test area as directed by Architect. Perform at least three tests, prior to 35, and 70 percent completion .
 - c. Water Penetration: ASTM E1105 at a minimum uniform and cyclic static-air-pressure differential of 0.67 times the static-air-pressure differential specified for laboratory testing in "Performance Requirements" Article, but not less than 6.24 lbf/sq. ft. (300 Pa), and shall not evidence water penetration.
4. STRUCTURAL-SEALANT ADHESION: TEST STRUCTURAL SEALANT ACCORDING TO RECOMMENDATIONS IN ASTM C1401, DESTRUCTIVE TEST METHOD A, "HAND PULL TAB (DESTRUCTIVE)," APPENDIX X2.
 - a. Test a minimum of four areas on each building facade.
 - b. Repair installation areas damaged by testing.

5. GLAZED ALUMINUM CURTAIN WALLS WILL BE CONSIDERED DEFECTIVE IF THEY DO NOT PASS TESTS AND INSPECTIONS.
6. PREPARE TEST AND INSPECTION REPORTS.

C.9 ALUMINUM-FRAMED ENTRANCES

1. SUMMARY

a. Section Includes:

- i Aluminum-framed entrance door systems.

2. PREINSTALLATION MEETINGS

- a. Preinstallation Conference: Conduct conference at Project site.

3. ACTION SUBMITTALS

a. Product Data: For each type of product.

- i Include construction details, material descriptions, dimensions of individual components and profiles, and finishes.

b. Shop Drawings: For aluminum-framed entrances and storefronts. Include plans, elevations, sections, full-size details, and attachments to other work.

- i Include details of provisions for assembly expansion and contraction and for draining moisture occurring within the assembly to the exterior.

- ii Include full-size isometric details of each type of vertical-to-horizontal intersection of aluminum-framed entrances and storefronts, showing the following:

- 1) Joinery, including concealed welds.
- 2) Anchorage.
- 3) Expansion provisions.
- 4) Glazing.
- 5) Flashing and drainage.

- iii Show connection to and continuity with adjacent thermal, weather, air, and vapor barriers.

- iv Include point-to-point wiring diagrams showing the following:

- 1) Power requirements for each electrically operated door hardware.
- 2) Location and types of switches, signal device, conduit sizes, and number and size of wires.

c. Samples for Initial Selection: For units with factory-applied color finishes.

d. Samples for Verification: For each type of exposed finish required, in manufacturer's standard sizes.

e. Fabrication Sample: Of each vertical-to-horizontal intersection of assemblies, made from 12-inch (300-mm) lengths of full-size components and showing details of the following:

- i Joinery, including concealed welds.
- ii Anchorage.
- iii Expansion provisions.
- iv Glazing.
- v Flashing and drainage.

- f. Entrance Door Hardware Schedule: Prepared by or under supervision of supplier, detailing fabrication and assembly of entrance door hardware, as well as procedures and diagrams. Coordinate final entrance door hardware schedule with doors, frames, and related work to ensure proper size, thickness, hand, function, and finish of entrance door hardware.
- g. Delegated Design Submittal: For aluminum-framed entrances and storefronts including analysis data signed and sealed by the qualified professional engineer responsible for their preparation.

4. INFORMATIONAL SUBMITTALS

- a. Certificates:
 - i Energy Performance Certificates: For aluminum-framed entrances and storefronts, accessories, and components, from manufacturer.
 - 1) Basis for Certification: NFRC-certified energy performance values for each aluminum-framed entrance and storefront.
- b. Test and Evaluation Reports:
 - i Product Test Reports: For aluminum-framed entrances and storefronts, for tests performed by manufacturer and witnessed by a qualified testing agency.
- c. Source Quality-Control Submittals:
 - i Source quality-control reports.
- d. Field Quality-Control Submittals:
 - i Field quality-control reports.
- e. Quality-Control Program: Developed specifically for Project, including fabrication and installation, according to recommendations in ASTM C1401. Include periodic quality-control reports.
- f. Qualification Statements:
 - i For Installer and laboratory mockup testing agency.
 - ii For egress door inspector.
 - 2) Submit documentation of compliance with NFPA 101, Section 7.2.1.15.4.
 - 3) Submit copy of DHI's Fire and Egress Door Assembly Inspector (FDAI) certificate.
- g. Delegated design engineer qualifications.
- h. Sample warranties.

5. CLOSEOUT SUBMITTALS

- a. Operation and Maintenance Data: For aluminum-framed entrances and storefronts.
- b. Maintenance Data for Structural Sealant: For structural-sealant-glazed storefront. Include ASTM C1401 recommendations for post-installation-phase quality-control program.

6. QUALITY ASSURANCE

- a. Qualifications:
 - i Installers: An entity that employs installers and supervisors who are trained and approved by manufacturer and that employs a qualified glazing contractor for this Project who is certified under the North American Contractor Certification Program (NACC) for Architectural Glass & Metal (AG&M) contractors and that employs glazing technicians certified under the Architectural Glass and Metal Technician (AGMT) certification program.

- ii Delegated Design Engineer: A professional engineer who is legally qualified to practice in the State of Wisconsin and who is experienced in providing engineering services of the type indicated.
- iii Laboratory Mockup Testing Agency: Qualified according to ASTM E699 for testing indicated and accredited by the International Accreditation Service or the International Laboratory Accreditation Cooperation Mutual Recognition Arrangement as complying with ISO/IEC 17025.
- iv Testing Agency: Qualified according to ASTM E699 for testing indicated and accredited by IAS or ILAC Mutual Recognition Arrangement as complying with ISO/IEC 17025 and acceptable to Owner and Architect.
- v Egress Door Inspector: Inspector for field quality-control inspections of egress door assemblies shall comply with qualifications set forth in NFPA 101, Section 7.2.1.15.4 and the following:
 - 1) DHI's Fire and Egress Door Assembly Inspector (FDAI) certification.
- b. Product Options: Information on Drawings and in Specifications establishes requirements for aesthetic effects and performance characteristics of assemblies. Aesthetic effects are indicated by dimensions, arrangements, alignment, and profiles of components and assemblies as they relate to sightlines, to one another, and to adjoining construction.
 - i Do not change intended aesthetic effects, as judged solely by Architect, except with Architect's approval. If changes are proposed, submit comprehensive explanatory data to Architect for review.
- c. Structural-Sealant Glazing: Comply with ASTM C1401 for design and installation of storefront systems that include structural glazing.

7. PRECONSTRUCTION TESTING

- a. Preconstruction Testing Service: Engage a qualified testing agency to perform preconstruction testing on laboratory mockups.
 - i Build preconstruction laboratory mockups at testing agency facility; use personnel, products, and methods of construction that will be used at Project site.
 - ii Size and Configuration: As indicated on Drawings.
 - iii Notify Architect 14 days in advance of the dates and times when preconstruction laboratory mockups will be constructed and tested.
- b. Preconstruction Laboratory Mockup Testing: Test preconstruction laboratory mockups according to requirements in "Performance Requirements" Article. Perform the following tests in the following order:
 - i Structural, 50 Percent: ASTM E330/E330M at 50 percent of positive test load.
 - ii Air Leakage: ASTM E283.
 - iii Water Penetration under Static Pressure: ASTM E331.
 - iv Water Penetration under Dynamic Pressure: AAMA 501.1.
 - v Thermal Cycling: AAMA 501.5. Repeat the following:
 - 1) Air Leakage: ASTM E283.
 - 2) Water Penetration under Static Pressure: ASTM E331.
 - vi Structural, 100 Percent: ASTM E330/E330M at 100 percent of positive and negative test loads. Repeat the following:
 - 1) Air Leakage: ASTM E283.
 - 2) Water Penetration under Static Pressure: ASTM E331.
 - 3) Water Penetration under Dynamic Pressure: AAMA 501.1.

- vii Structural, 150 Percent: ASTM E330/E330M at 150 percent of positive and negative test loads.
- c. Preconstruction Adhesion and Compatibility Testing: Submit to structural glazing sealant manufacturer, for testing indicated below, Samples of each glazing material type, tape sealant, gasket, glazing accessory, and glass-framing member that is in close proximity to or is touching the structural or nonstructural sealants of a structural glazed system.
 - i Compatibility: Test materials or components using ASTM C1087.
 - ii Adhesion: Test for adhesion or lack of adhesion of a structural sealant to the surface of another material or component using ASTM C1135.
 - iii Submit no fewer than eight pieces of each type of material, including joint substrates, shims, joint-sealant backings, secondary seals, and miscellaneous materials.
 - iv Schedule sufficient time for testing and analyzing results to prevent delaying the Work.
 - v For materials failing tests, obtain sealant manufacturer's written instructions for corrective measures, including the use of specially formulated primers.
 - vi Testing will not be required if data based on previous testing of current sealant products match those submitted.

8. WARRANTY

- a. Special Warranty: Installer agrees to repair or replace components of aluminum-framed entrances and storefronts that do not comply with requirements or that fail in materials or workmanship within specified warranty period.
 - i Failures include, but are not limited to, the following:
 - 1) Structural failures, including, but not limited to, excessive deflection.
 - 2) Noise or vibration created by wind and thermal and structural movements.
 - 3) Deterioration of metals, metal finishes, and other materials beyond normal weathering.
 - 4) Water penetration through fixed glazing and framing areas.
 - 5) Failure of operating components.
 - ii Warranty Period: One year from date of Substantial Completion.
- b. Special Finish Warranty, Factory-Applied Finishes: Standard form in which manufacturer agrees to repair finishes or replace aluminum that shows evidence of deterioration of factory-applied finishes within specified warranty period.
 - i Deterioration includes, but is not limited to, the following:
 - 1) Color fading more than 5 Delta E units when tested according to ASTM D2244.
 - 2) Chalking in excess of a No. 8 rating when tested according to ASTM D4214.
 - 3) Cracking, checking, peeling, or failure of paint to adhere to bare metal.
 - ii Warranty Period: 10 years from date of Substantial Completion.
- c. Special Finish Warranty, Anodized Finishes: Standard form in which manufacturer agrees to repair finishes or replace aluminum that shows evidence of deterioration of anodized finishes within specified warranty period.
 - i Deterioration includes, but is not limited to, the following:
 - 1) Color fading more than 5 Delta E units when tested according to ASTM D 2244.
 - 2) Chalking in excess of a No. 8 rating when tested according to ASTM D 4214.
 - 3) Cracking, peeling, or chipping.
 - ii Warranty Period: 10 years from date of Substantial Completion.

9. MANUFACTURERS

- a. Source Limitations: Obtain all components of aluminum-framed entrance and storefront system, including framing spandrel panels venting windows and accessories, from single manufacturer.

10. PERFORMANCE REQUIREMENTS

- a. Delegated Design: Engage a qualified professional engineer, as defined in Section "Quality Requirements," to design aluminum-framed entrances and storefronts.
- b. General Performance: Comply with performance requirements specified, as determined by testing of aluminum-framed entrances and storefronts representing those indicated for this Project without failure due to defective manufacture, fabrication, installation, or other defects in construction.
 - i Aluminum-framed entrances and storefronts shall withstand movements of supporting structure, including, but not limited to, twist, column shortening, long-term creep, and deflection from uniformly distributed and concentrated live loads.
 - ii Failure also includes the following:
 - 1) Thermal stresses transferring to building structure.
 - 2) Glass breakage.
 - 3) Noise or vibration created by wind and thermal and structural movements.
 - 4) Loosening or weakening of fasteners, attachments, and other components.
 - 5) Failure of operating units.
- c. Structural Loads:
 - i Wind Loads: As indicated on Drawings.
 - ii Other Design Loads: As indicated on Drawings
- d. Deflection of Framing Members Supporting Glass: At design wind load, as follows:
 - i Deflection Normal to Wall Plane: Limited to 1/175 of clear span for spans of up to 13 feet 6 inches (4.1 m) and to 1/240 of clear span plus 1/4 inch (6.35 mm) for spans greater than 13 feet 6 inches (4.1 m).
 - ii Deflection Parallel to Glazing Plane: Limited to amount not exceeding that which reduces glazing bite to less than 75 percent of design dimension and that which reduces edge clearance between framing members and glazing or other fixed components to less than 1/8 inch (3.2 mm).
 - 1) Operable Units: Provide a minimum 1/16-inch (1.6-mm) clearance between framing members and operable units.
 - iii Cantilever Deflection: Limited to 2L/175 at unsupported cantilevers.
- e. Structural: Test according to ASTM E330/E330M as follows:
 - i When tested at positive and negative wind-load design pressures, storefront assemblies, including entrance doors, do not evidence deflection exceeding specified limits.
 - ii When tested at 150 percent of positive and negative wind-load design pressures, storefront assemblies, including entrance doors and anchorage, do not evidence material failures, structural distress, or permanent deformation of main framing members exceeding 0.2 percent of span.
 - iii Test Durations: As required by design wind velocity, but not less than 10 seconds.

- f. Water Penetration under Static Pressure: Test according to ASTM E331 as follows:
 - i No evidence of water penetration through fixed glazing and framing areas, including entrance doors, when tested according to a minimum static-air-pressure differential of 20 percent of positive wind-load design pressure, but not less than 6.24 lbf/sq. ft. (300 Pa) 10 lbf/sq. ft. (480 Pa) 15 lbf/sq. ft. (720 Pa).
- g. Water Penetration under Dynamic Pressure: Test according to AAMA 501.1 as follows:
 - i No evidence of water penetration through fixed glazing and framing areas when tested at dynamic pressure equal to 20 percent of positive wind-load design pressure, but not less than 6.24 lbf/sq. ft. (300 Pa) 10 lbf/sq. ft. (480 Pa) 15 lbf/sq. ft. (720 Pa).
 - ii Maximum Water Leakage: According to AAMA 501.1 No uncontrolled water penetrating assemblies or water appearing on assemblies' normally exposed interior surfaces from sources other than condensation. Water leakage does not include water controlled by flashing and gutters, or water that is drained to exterior.
- h. Seismic Performance: Aluminum-framed entrances and storefronts shall withstand the effects of earthquake motions determined according to ASCE/SEI 7.
 - i Seismic Drift Causing Glass Fallout: Complying with criteria for passing based on building occupancy type when tested according to AAMA 501.6 at design displacement and 1.5 times the design displacement.
- i. Energy Performance: Certified and labeled by manufacturer for energy performance as follows:
 - i Thermal Transmittance (U-factor):
 - 1) Fixed Glazing and Framing Areas: U-factor for the system of not more than 0.41 Btu/sq. ft. x h x deg F (2.33 W/sq. m x K) 0.45 Btu/sq. ft. x h x deg F (2.55 W/sq. m x K) 0.57 Btu/sq. ft. x h x deg F (3.23 W/sq. m x K) 0.69 Btu/sq. ft. x h x deg F (3.92 W/sq. m x K) as determined according to NFRC 100.
 - 2) Entrance Doors: U-factor of not more than 0.68 Btu/sq. ft. x h x deg F (3.86 W/sq. m x K) 0.77 Btu/sq. ft. x h x deg F (4.37 W/sq. m x K) 0.83 Btu/sq. ft. x h x deg F (4.71 W/sq. m x K) 1.10 Btu/sq. ft. x h x deg F (6.253 W/sq. m x K) as determined according to NFRC 100.
 - 3) Venting Windows: Whole window U-factor of not more than 0.37 Btu/sq. ft. x h x deg F (2.10 W/sq. m x K) 0.43 Btu/sq. ft. x h x deg F (2.44 W/sq. m x K) 0.45 Btu/sq. ft. x h x deg F (2.55 W/sq. m x K) 0.60 Btu/sq. ft. x h x deg F (3.40 W/sq. m x K) 0.65 Btu/sq. ft. x h x deg F (3.69 W/sq. m x K) as determined according to NFRC 100.
 - ii Solar Heat-Gain Coefficient (SHGC):
 - 1) Fixed Glazing and Framing Areas: SHGC for the system of not more than 0.26 0.35 0.40 0.45 as determined according to NFRC 200.
 - 2) Entrance Doors: SHGC of not more than 0. as determined according to NFRC 200.
 - 3) Venting Windows: Whole window SHGC of not more than 0.40 as determined according to NFRC 200.
 - iii Air Leakage:
 - 1) Fixed Glazing and Framing Areas: Air leakage for the system of not more than 0.06 cfm/sq. ft. (0.30 L/s per sq. m) at a static-air-pressure differential of 1.57 lbf/sq. ft. (75 Pa) 6.24 lbf/sq. ft. (300 Pa) when tested according to ASTM E283.
 - 2) Entrance Doors: Air leakage of not more than 1.0 cfm/sq. ft. (5.08 L/s per sq. m) at a static-air-pressure differential of 1.57 lbf/sq. ft. (75 Pa).

- iv Condensation Resistance Factor (CRF):
 - 1) Fixed Glazing and Framing Areas: CRF for the system of not less than 35 55 70 as determined according to AAMA 1503.
 - 2) Entrance Doors: CRF of not less than 57 63 68 as determined according to AAMA 1503.
- v Outdoor-Indoor Transmission Class: Minimum 26 30 34 .
- j. Blast Resistance:
 - i Hazard Rating: Low Hazard Moderate Hazard according to ASTM F2912, tested according to ASTM F1642/F1642M.
 - ii Performance Condition: 1 2 3a 3b 4 5 according to GSA-TS01.
- k. Windborne-Debris Impact Resistance: Passes ASTM E1886 missile-impact and cyclic-pressure tests according to ASTM E1996 for Wind Zone 1 2 3 4 for basic enhanced protection.
 - i Small-Missile Test: For glazing located between 30 feet (9.1 m) and 60 feet (18.3 m) above grade.
- l. Thermal Movements: Allow for thermal movements resulting from ambient and surface temperature changes.
 - i Temperature Change: 120 deg F (67 deg C), ambient; 180 deg F (100 deg C), material surfaces.
 - 1) High Exterior Ambient-Air Temperature: That which produces an exterior metal-surface temperature of 180 deg F (82 deg C).
 - 2) Low Exterior Ambient-Air Temperature: 0 deg F (minus 18 deg C).
 - 3) Interior Ambient-Air Temperature: 75 deg F (24 deg C).

11. ENTRANCE DOOR SYSTEMS

- a. Manufacturers: Kawneer, Oldcastle or approved equal
- b. Entrance Doors: Manufacturer's standard glazed entrance doors for manual-swing or automatic operation.
 - i Door Construction: 1-3/4-inch (44.5-mm) overall thickness, with minimum 0.125-inch- (3.2-mm-) 2-inch (50.8-mm) overall thickness, with minimum 0.188-inch- (4.8-mm-) 2- to 2-1/4-inch (50.8- to 57.2-mm) overall thickness, with minimum 0.125-inch- (3.2-mm-) thick, extruded-aluminum tubular rail and stile members. Mechanically fasten corners with reinforcing brackets that are deeply penetrated and fillet welded or that incorporate concealed tie rods.
 - 1) Thermal Construction: High-performance plastic connectors separate aluminum members exposed to the exterior from members exposed to the interior .
 - ii Door Design; 3-1/2-inch (88.9-mm) nominal width Wide stile; 5-inch (127-mm) nominal width
 - iii Glazing Stops and Gaskets: Beveled, snap-on, extruded-aluminum stops and preformed gaskets.
 - iv Finish: Match adjacent storefront framing finish.

12. ENTRANCE DOOR HARDWARE

- a. Entrance Door Hardware: Hardware not specified in this Section is specified in "Door Hardware."
- b. General: Provide entrance door hardware and entrance door hardware sets indicated in door and frame schedule entrance door hardware sets indicated in "Entrance Door Hardware Sets" Article for each entrance door, to comply with requirements in this Section.

- i Entrance Door Hardware Sets: Provide quantity, item, size, finish or color indicated, and named manufacturers' products products equivalent in function and comparable in quality to named products products complying with BHMA standard referenced.
- ii Sequence of Operation: Provide electrified door hardware function, sequence of operation, and interface with other building control systems indicated.
- iii Opening-Force Requirements:
 - 1) Egress Doors: Not more than 15 lbf (67 N) to release the latch and not more than 30 lbf (133 N) to set the door in motion and not more than 15 lbf (67 N) to open the door to its minimum required width.
 - 2) Accessible Interior Doors: Not more than 5 lbf (22.2 N) to fully open door.
- c. Designations: Requirements for design, grade, function, finish, quantity, size, and other distinctive qualities of each type of entrance door hardware are indicated in "Entrance Door Hardware Sets" Article. Products are identified by using entrance door hardware designations as follows:
 - i Named Manufacturers' Products: Manufacturer and product designation are listed for each door hardware type required for the purpose of establishing minimum requirements. Manufacturers' names are abbreviated in "Entrance Door Hardware Sets" Article.
 - ii References to BHMA Standards: Provide products complying with these standards and requirements for description, quality, and function.
- d. Pivot Hinges: BHMA A156.4, Grade 1.
 - i Offset-Pivot Hinges: Provide top, bottom, and intermediate offset pivots at each door leaf.
- e. Butt Hinges: BHMA A156.1, Grade 1, radius corner.
 - i Nonremovable Pins: Provide setscrew in hinge barrel that, when tightened into a groove in hinge pin, prevents removal of pin while entrance door is closed.
 - ii Exterior Hinges: Stainless steel, with stainless steel pin Nonferrous.
 - iii Quantities:
 - 1) For doors up to 87 inches (2210 mm) high, provide three hinges per leaf.
 - 2) For doors more than 87 and up to 120 inches (2210 and up to 3048 mm) high, provide four hinges per leaf.
- f. Continuous-Gear Hinges: BHMA A156.26.
- g. Mortise Auxiliary Locks: BHMA A156.5, Grade 1.
- h. Manual Flush Bolts: BHMA A156.16, Grade 1.
- i. Automatic and Self-Latching Flush Bolts: BHMA A156.3, Grade 1.
- j. Panic Exit Devices: BHMA A156.3, Grade 1, listed and labeled by a testing and inspecting agency acceptable to authorities having jurisdiction, for panic protection, based on testing according to UL 305.
- k. Cylinders:
 - i As specified in "Door Hardware."
 - ii BHMA A156.5, Grade 1.
 - 1) Keying: Master key system. Permanently inscribe each key with a visual key control number and include notation "DO NOT DUPLICATE" to be furnished by Owner.

- l. Strikes: Provide strike with black-plastic dust box for each latch or lock bolt; fabricated for aluminum framing.
- m. Operating Trim: BHMA A156.6.
- n. Removable Mullions: BHMA A156.3 extruded aluminum.
 - i. When used with panic exit devices, provide keyed removable mullions listed and labeled by a testing and inspecting agency acceptable to authorities having jurisdiction, for panic protection, based on testing according to UL 305. Use only mullions that have been tested with exit devices to be used.
- o. Closers: BHMA A156.4, Grade 1, with accessories required for a complete installation, sized as required by door size, exposure to weather, and anticipated frequency of use; adjustable to comply with field conditions and requirements for opening force.
- p. Concealed Overhead Holders and Stops: BHMA A156.8, Grade 1.
- q. Door Stops: BHMA A156.16, Grade 1, floor or wall mounted, as appropriate for door location indicated, with integral rubber bumper.
- r. Weather Stripping: Manufacturer's standard replaceable components.
 - i. Compression Type: Made of ASTM D2000 molded neoprene or ASTM D2287 molded PVC.
 - ii. Sliding Type: AAMA 701/702, made of wool, polypropylene, or nylon woven pile with nylon-fabric or aluminum-strip backing.
- s. Weather Sweeps: Manufacturer's standard exterior-door bottom sweep with concealed fasteners on mounting strip.
- t. Thresholds: BHMA A156.21 raised thresholds beveled with a slope of not more than 1:2, with maximum height of 1/2 inch (12.7 mm).

13. GLAZING

- a. Glazing: Comply with Section "Glazing."
- b. Glazing Gaskets: Manufacturer's standard sealed-corner pressure-glazing system of black, resilient elastomeric glazing gaskets, setting blocks, and shims or spacers in "Glazing."
- c. Structural Glazing Sealants: ASTM C1184 chemically curing silicone formulation that is compatible with system components with which it comes in contact; specifically formulated and tested for use as structural sealant and approved by structural-sealant manufacturer for use in storefront system indicated.
 - i. Color: As selected by Architect from manufacturer's full range of colors
- d. Weatherseal Sealants: ASTM C920 for Type S; Grade NS; Class 25; Uses NT, G, A, and O; chemically curing silicone formulation that is compatible with structural sealant and other system components with which it comes in contact; recommended by structural-sealant, weatherseal-sealant, and structural-sealant-glazed storefront manufacturers for this use.
 - i. Color: Match structural sealant.

14. MATERIALS

- a. Sheet and Plate: ASTM B209 (ASTM B209M).
- b. Extruded Bars, Rods, Profiles, and Tubes: ASTM B221 (ASTM B221M).
- c. Structural Profiles: ASTM B308/B308M.
- d. Steel Reinforcement:
 - i. Cold-Rolled Sheet and Strip: ASTM A1008/A1008M.

- e. Steel Reinforcement Primer: Manufacturer's standard zinc-rich, corrosion-resistant primer complying with SSPC-PS Guide No. 12.00; applied immediately after surface preparation and pretreatment. Select surface preparation methods according to recommendations in SSPC-SP COM, and prepare surfaces according to applicable SSPC standard.

15. ACCESSORIES

- a. Fasteners and Accessories: Manufacturer's standard corrosion-resistant, nonstaining, nonbleeding fasteners and accessories compatible with adjacent materials.
 - i Use self-locking devices where fasteners are subject to loosening or turning out from thermal and structural movements, wind loads, or vibration.
 - ii Reinforce members as required to receive fastener threads.
 - iii Use exposed fasteners with countersunk Phillips screw heads, finished to match framing system, fabricated from 300 series stainless steel.
- b. Anchors: Three-way adjustable anchors with minimum adjustment of 1 inch (25.4 mm) that accommodate fabrication and installation tolerances in material and finish compatible with adjoining materials and recommended by manufacturer.
 - i Concrete and Masonry Inserts: Hot-dip galvanized cast-iron, malleable-iron, or steel inserts complying with ASTM A123/A123M or ASTM A153/A153M requirements.
- c. Concealed Flashing: Manufacturer's standard corrosion-resistant, nonstaining, nonbleeding flashing compatible with adjacent materials Dead-soft, 0.018-inch- (0.457-mm-) thick stainless steel, complying with ASTM A240/A240M, of type recommended by manufacturer.
- d. Bituminous Paint: Cold-applied asphalt-mastic paint containing no asbestos, formulated for 30-mil (0.762-mm) thickness per coat.
- e. Rigid PVC filler.

16. FABRICATION

- a. Form or extrude aluminum shapes before finishing.
- b. Weld in concealed locations to greatest extent possible to minimize distortion or discoloration of finish. Remove weld spatter and welding oxides from exposed surfaces by descaling or grinding.
- c. Fabricate components that, when assembled, have the following characteristics:
 - i Profiles that are sharp, straight, and free of defects or deformations.
 - ii Accurately fitted joints with ends coped or mitered.
 - iii Physical and thermal isolation of glazing from framing members.
 - iv Accommodations for thermal and mechanical movements of glazing and framing to maintain required glazing edge clearances.
 - v Provisions for field replacement of glazing from exterior interior interior for vision glass and exterior for spandrel glazing or metal panels.
 - vi Fasteners, anchors, and connection devices that are concealed from view to greatest extent possible.
- d. Mechanically Glazed Framing Members: Fabricate for flush glazing without projecting stops.
- e. Structural-Sealant-Glazed Framing Members: Include accommodations for using temporary support device to retain glazing in place while structural sealant cures.
- f. Entrance Door Frames: Reinforce as required to support loads imposed by door operation and for installing entrance door hardware.
 - i At interior and exterior doors, provide compression weather stripping at fixed stops.

- g. Entrance Doors: Reinforce doors as required for installing entrance door hardware.
 - i. At pairs of exterior doors, provide sliding-type weather stripping retained in adjustable strip and mortised into door edge.
 - ii. At exterior doors, provide weather sweeps applied to door bottoms.
- h. Entrance Door Hardware Installation: Factory install entrance door hardware to the greatest extent possible. Cut, drill, and tap for factory-installed entrance door hardware before applying finishes.
- i. After fabrication, clearly mark components to identify their locations in Project according to Shop Drawings.

17. ALUMINUM FINISHES

- a. Color Anodic Finish: AAMA 611, AA-M12C22A42/A44, Class I, 0.018 mm AA-M12C22A32/A34, Class II, 0.010 mm or thicker.
 - i. Color: As selected by Architect from full range of industry colors and color densities.
- b. Baked-Enamel or Powder-Coat Finish: AAMA 2603 except with a minimum dry film thickness of 1.5 mils (0.04 mm). Comply with coating manufacturer's written instructions for cleaning, conversion coating, and applying and baking finish.
 - i. Color and Gloss: As selected by Architect from manufacturer's full range.

18. SOURCE QUALITY CONTROL

- a. Structural Sealant: Perform quality-control procedures complying with ASTM C1401 recommendations, including, but not limited to, assembly material qualification procedures, sealant testing, and assembly fabrication reviews and checks.

19. EXAMINATION

- a. Examine areas, with Installer present, for compliance with requirements for installation tolerances and other conditions affecting performance of the Work.
- b. Proceed with installation only after unsatisfactory conditions have been corrected.

20. INSTALLATION, GENERAL

- a. Comply with manufacturer's written instructions.
- b. Do not install damaged components.
- c. Fit joints to produce hairline joints free of burrs and distortion.
- d. Rigidly secure nonmovement joints.
- e. Install anchors with separators and isolators to prevent metal corrosion and electrolytic deterioration and to prevent impeding movement of moving joints.
- f. Seal perimeter and other joints watertight unless otherwise indicated.
- g. Metal Protection:
 - i. Where aluminum is in contact with dissimilar metals, protect against galvanic action by painting contact surfaces with materials recommended by manufacturer for this purpose or by installing nonconductive spacers.
 - ii. Where aluminum is in contact with concrete or masonry, protect against corrosion by painting contact surfaces with bituminous paint.
- h. Set continuous sill members and flashing in full sealant bed, as specified in Section "Joint Sealants," to produce weathertight installation.
- i. Install joint filler behind sealant as recommended by sealant manufacturer.
- j. Install components plumb and true in alignment with established lines and grades.

21. INSTALLATION OF OPERABLE UNITS

- a. Install operable units level and plumb, securely anchored, and without distortion. Adjust weather-stripping contact and hardware movement to produce proper operation.

22. INSTALLATION OF GLAZING

- a. Install glazing as specified in Section "Glazing."

23. INSTALLATION OF STRUCTURAL GLAZING

- a. Prepare surfaces that will contact structural sealant according to sealant manufacturer's written instructions, to ensure compatibility and adhesion. Preparation includes, but is not limited to, cleaning and priming surfaces.
- b. Set glazing into framing according to sealant manufacturer and framing manufacturer's written instructions and standard practice. Use a spacer or backer as recommended by manufacturer.
- c. Set glazing with proper orientation so that coatings face exterior or interior as specified.
- d. Hold glazing in place using temporary retainers of type and spacing recommended by manufacturer, until structural sealant joint has cured.
- e. Apply structural sealant to completely fill cavity, according to sealant manufacturer and framing manufacturer's written instructions and in compliance with local codes.
- f. Apply structural sealant at temperatures indicated by sealant manufacturer for type of sealant.
- g. Allow structural sealant to cure according to manufacturer's written instructions.
- h. Clean and protect glass as indicated in Section "Glazing."

24. INSTALLATION OF WEATHERSEAL SEALANT

- a. After structural sealant has completely cured, remove temporary retainers and insert backer rod between lites of glass as recommended by sealant manufacturer.
- b. Install weatherseal sealant to completely fill cavity, according to sealant manufacturer's written instructions, to produce weatherproof joints.

25. INSTALLATION OF ALUMINUM-FRAMED ENTRANCE DOORS

- a. Install entrance doors to produce smooth operation and tight fit at contact points.
 - i. Exterior Doors: Install to produce weathertight enclosure and tight fit at weather stripping.
 - ii. Field-Installed Entrance Door Hardware: Install surface-mounted entrance door hardware according to entrance door hardware manufacturers' written instructions using concealed fasteners to greatest extent possible.

26. ERECTION TOLERANCES

- a. Install aluminum-framed entrances and storefronts to comply with the following maximum tolerances:
 - i. Plumb: 1/8 inch in 10 feet (3.2 mm in 3 m); 1/4 inch in 40 feet (6.35 mm in 12.2 m).
 - ii. Level: 1/8 inch in 20 feet (3.2 mm in 6 m); 1/4 inch in 40 feet (6.35 mm in 12.2 m).
 - iii. Alignment:
 - 1) Where surfaces abut in line or are separated by reveal or protruding element up to 1/2 inch (12.7 mm) wide, limit offset from true alignment to 1/16 inch (1.6 mm).
 - 2) Where surfaces are separated by reveal or protruding element from 1/2 to 1 inch (12.7 to 25.4 mm) wide, limit offset from true alignment to 1/8 inch (3.2 mm).
 - 3) Where surfaces are separated by reveal or protruding element of 1 inch (25.4 mm) wide or more, limit offset from true alignment to 1/4 inch (6 mm).

- iv Location: Limit variation from plane to 1/8 inch in 12 feet (3.2 mm in 3.6 m); 1/2 inch (12.7 mm) over total length.

27. FIELD QUALITY CONTROL

- a. Testing Agency: Owner will engage Engage a qualified testing agency to perform tests and inspections.
- b. Tests and Inspections: Perform the following tests on representative areas of aluminum-framed entrances and storefronts mockups.
 - i Water-Spray Test: Before installation of interior finishes has begun, areas designated by Architect shall be tested according to AAMA 501.2 and shall not evidence water penetration.
 - 1) Perform a minimum of two tests in areas as directed by Architect.
 - ii Air Leakage: ASTM E783 at 1.5 times the rate specified for laboratory testing in "Performance Requirements" Article but not more than 0.09 cfm/sq. ft. (0.45 L/s per sq. m) at a static-air-pressure differential of 1.57 lbf/sq. ft. (75 Pa).
 - 1) Perform a minimum of two tests in areas as directed by Architect.
 - iii Water Penetration: ASTM E1105 at a minimum uniform and cyclic static-air-pressure differential of 0.67 times the static-air-pressure differential specified for laboratory testing in "Performance Requirements" Article, but not less than 6.24 lbf/sq. ft. (300 Pa), and shall not evidence water penetration.
 - iv Structural-Sealant Adhesion: Test structural sealant according to recommendations in ASTM C1401, Destructive Test Method A, "Hand Pull Tab (Destructive)," Appendix X2.
 - 1) Test a minimum of two areas on each building facade.
 - 2) Repair installation areas damaged by testing.
- c. Aluminum-framed entrances and storefronts will be considered defective if they do not pass tests and inspections.
- d. Prepare test and inspection reports.

28. MAINTENANCE SERVICE

- a. Entrance Door Hardware Maintenance:
 - i Maintenance Tools and Instructions: Furnish a complete set of specialized tools and maintenance instructions as needed for Owner's continued adjustment, maintenance, and removal and replacement of entrance door hardware.
 - ii Initial Maintenance Service: Beginning at Substantial Completion, provide six months' full maintenance by skilled employees of entrance door hardware Installer. Include quarterly preventive maintenance, repair or replacement of worn or defective components, lubrication, cleaning, and adjusting as required for proper entrance door hardware operation at rated speed and capacity. Use parts and supplies that are the same as those used in the manufacture and installation of original equipment.

C.10 GLAZING

29. SUMMARY

- a. Section Includes:
 - i TYPE A: Bridge curtain wall - Low E, 1" Laminated, Tempered and insulated glass.
 - ii TYPE B: All curtain walls and windows at towers and 1 story connection corridor:
Low E, 1" Tempered and insulated glass
 - iii TYPE C: Tempered 1/2" glass for double door entrance
 - iv TYPE D 5/16" Fire resistive glass at double fire rated door to existing station

- v Glazing sealants.
- vi Glazing tapes.
- vii Miscellaneous glazing materials.

30. DEFINITIONS

- a. Glass Manufacturers: Firms that produce primary glass, fabricated glass, or both, as defined in referenced glazing publications.
- b. Glass Thicknesses: Indicated by thickness designations in millimeters according to ASTM C1036.
- c. IBC: International Building Code.
- d. Interspace: Space between lites of an insulating-glass unit.

31. COORDINATION

- a. Coordinate glazing channel dimensions to provide necessary bite on glass, minimum edge and face clearances, and adequate sealant thicknesses, with reasonable tolerances to achieve proper safety margins for glazing retention under each design load case, load case combination, and service condition.

32. PREINSTALLATION MEETINGS

- a. Preinstallation Conference: Conduct conference at Project site.
 - i Review and finalize construction schedule and verify availability of materials, Installer's personnel, equipment, and facilities needed to make progress and avoid delays.
 - ii Review temporary protection requirements for glazing during and after installation.

33. ACTION SUBMITTALS

- a. Product Data: For each type of product.
- b. Sustainable Design Submittals:
- c. Glass Samples: For each type of glass product other than clear monolithic vision glass the following products; 12 inches (300 mm) square.
 - i Laminated and insulated glass.
 - ii Spandrel glass.
- d. Glazing Accessory Samples: For sealants, in 12-inch (300-mm) lengths. Install sealant Samples between two strips of material representative in color of adjoining framing system.
- e. Glazing Schedule: List glass types and thicknesses for each size opening and location. Use same designations indicated on Drawings.
- f. Delegated Design Submittal: For glass indicated to comply with performance requirements and design criteria, including analysis data signed and sealed by qualified professional engineer responsible for their preparation.

34. INFORMATIONAL SUBMITTALS

- a. Qualification Data: For manufacturers of fabricated glass units
- b. Retain "Product Certificates" Paragraph below to require submittal of product certificates from manufacturers.
- c. Product Certificates: For glass.
- d. Product Test Reports: For fabricated glass and glazing sealants, for tests performed by a qualified testing agency.
 - i For glazing sealants, provide test reports based on testing current sealant formulations within previous 36-month period.

- e. Preconstruction adhesion and compatibility test report.
- f. Sample Warranties: For special warranties.

35. QUALITY ASSURANCE

- a. Fabricated-Glass Manufacturer Qualifications: A qualified manufacturer of fabricated glass units who is approved and certified by primary glass manufacturer.
- b. Installer Qualifications: A qualified glazing contractor for this Project who is certified under the North American Contractor Certification Program (NACC) for Architectural Glass & Metal (AG&M) contractors and who employs glazing technicians certified under the Architectural Glass and Metal Technician (AGMT) certification program.
- c. Glass Testing Agency Qualifications: A qualified independent testing agency accredited according to the NFRC CAP 1 Certification Agency Program.
- d. Sealant Testing Agency Qualifications: An independent testing agency qualified according to ASTM C1021 to conduct the testing indicated.
- e. Mockups: Build mockups to demonstrate aesthetic effects and to set quality standards for materials and execution.
 - i. Install glazing in mockups specified in "Aluminum-Framed Entrances and Storefronts" "Aluminum Windows" "Glazed Aluminum Curtain Walls" to match glazing systems required for Project, including glazing methods.
 - ii. Subject to compliance with requirements, approved mockups may become part of the completed Work if undisturbed at time of Substantial Completion.

36. PRECONSTRUCTION TESTING

- a. Preconstruction Adhesion and Compatibility Testing: Test each glass product, tape sealant, gasket, glazing accessory, and glass-framing member for adhesion to and compatibility with elastomeric glazing sealants.
 - i. Testing is not required if data are submitted based on previous testing of current sealant products and glazing materials matching those submitted.
 - ii. Use ASTM C1087 to determine whether priming and other specific joint-preparation techniques are required to obtain rapid, optimum adhesion of glazing sealants to glass, tape sealants, gaskets, and glazing channel substrates.
 - iii. Test no fewer than eight Samples of each type of material, including joint substrates, shims, sealant backings, secondary seals, and miscellaneous materials.
 - iv. Schedule enough time for testing and analyzing results to prevent delaying the Work.
 - v. For materials failing tests, submit sealant manufacturer's written instructions for corrective measures including use of specially formulated primers.

37. DELIVERY, STORAGE, AND HANDLING

- a. Protect glazing materials according to manufacturer's written instructions. Prevent damage to glass and glazing materials from condensation, temperature changes, direct exposure to sun, or other causes.
- b. Comply with insulating-glass manufacturer's written instructions for venting and sealing units to avoid hermetic seal ruptures due to altitude change.

38. FIELD CONDITIONS

- a. Environmental Limitations: Do not proceed with glazing when ambient and substrate temperature conditions are outside limits permitted by glazing material manufacturers and when glazing channel substrates are wet from rain, frost, condensation, or other causes.
 - i. Do not install glazing sealants when ambient and substrate temperature conditions are outside limits permitted by sealant manufacturer or are below 40 deg F (4.4 deg C).

39. WARRANTY

- a. Manufacturer's Special Warranty for Coated-Glass Products: Manufacturer agrees to replace coated-glass units that deteriorate within specified warranty period. Deterioration of coated glass is defined as defects developed from normal use that are not attributed to glass breakage or to maintaining and cleaning coated glass contrary to manufacturer's written instructions. Defects include peeling, cracking, and other indications of deterioration in coating.
 - i Warranty Period: 10 years from date of Substantial Completion.
- b. Manufacturer's Special Warranty for Laminated Glass: Manufacturer agrees to replace laminated-glass units that deteriorate within specified warranty period. Deterioration of laminated glass is defined as defects developed from normal use that are not attributed to glass breakage or to maintaining and cleaning laminated glass contrary to manufacturer's written instructions. Defects include edge separation, delamination materially obstructing vision through glass, and blemishes exceeding those allowed by referenced laminated-glass standard.
 - i Warranty Period: 10 years from date of Substantial Completion.
- c. Manufacturer's Special Warranty for Insulating Glass: Manufacturer agrees to replace insulating-glass units that deteriorate within specified warranty period. Deterioration of insulating glass is defined as failure of hermetic seal under normal use that is not attributed to glass breakage or to maintaining and cleaning insulating glass contrary to manufacturer's written instructions. Evidence of failure is obstruction of vision by dust, moisture, or film on interior surfaces of glass.
 - i Warranty Period: 10 years from date of Substantial Completion.
- d. Manufacturer's Special Warranty for Heat-Soaked Tempered Glass: Manufacturer agrees to replace heat-soaked tempered glass units that spontaneously break due to nickel sulfide (NiS) inclusions at a rate exceeding 0.3 percent (3/1000) within specified warranty period. Coverage for any other cause is excluded.
 - i Warranty Period: Five years from date of Substantial Completion.

40. MANUFACTURERS

- a. Source Limitations for Glass: Obtain tinted and coated glass from single source from single manufacturer.
- b. Source Limitations for Glazing Accessories: For each product and installation method, obtain from single source from single manufacturer.

41. PERFORMANCE REQUIREMENTS

- a. General: Installed glazing systems shall withstand normal thermal movement and wind and impact loads (where applicable) without failure, including loss or glass breakage attributable to defective manufacture, fabrication, or installation; failure of sealants or gaskets to remain watertight and airtight; deterioration of glazing materials; or other defects in construction.
- b. Delegated Design: Engage a qualified professional engineer, as defined in "Quality Requirements," to design glazing.
- c. Structural Performance: Glazing shall withstand the following design loads within limits and under conditions indicated determined according to the IBC and ASTM E1300:
 - i Design Wind Pressures: As indicated on Drawings Determine design wind pressures applicable to Project according to ASCE/SEI 7, based on heights above grade indicated on Drawings.
 - 1) Wind Design Data: As indicated on Drawings.
 - 2) Basic Wind Speed: 100 mph (49 m/s)
 - 3) Importance Factor: 1.0 >.
 - 4) Exposure Category: B

- ii Design Snow Loads: As indicated on Drawings.
 - iii Probability of Breakage for Sloped Glazing: For glass sloped more than 15 degrees from vertical, design glass for a probability of breakage not greater than 0.001.
 - iv Maximum Lateral Deflection: For glass supported on all four edges, limit center-of-glass deflection at design wind pressure to not more than 1/50 times the short-side length or 1 inch (25 mm), whichever is less.
 - v Thermal Loads: Design glazing to resist thermal stress breakage induced by differential temperature conditions and limited air circulation within individual glass lites and insulated glazing units.
- d. Windborne-Debris-Impact Resistance: Exterior glazing shall pass ASTM E1886 missile-impact and cyclic-pressure tests according to ASTM E1996 for Wind Zone 2 for protection.
- i Small-Missile Test: For glazing located between 30 feet (9.1 m) and 60 feet (18.3 m) above grade.
- e. Safety Glazing: Where safety glazing is indicated, provide glazing that complies with 16 CFR 1201, Category II.
- f. Thermal and Optical Performance Properties: Provide glass with performance properties specified, as indicated in manufacturer's published test data, based on procedures indicated below:
- i For monolithic-glass lites, properties are based on units with lites 6 mm thick of thickness indicated.
 - ii For laminated-glass lites, properties are based on products of construction indicated.
 - iii For insulating-glass units, properties are based on units of thickness indicated for overall unit and for each lite.
 - iv U-Factors: Center-of-glazing values, according to NFRC 100 and based on most current non-beta version of LBL's WINDOW computer program, expressed as Btu/sq. ft. x h x deg F (W/sq. m x K).
 - v SHGC and Visible Transmittance: Center-of-glazing values, according to NFRC 200 and based on most current non-beta version of LBL's WINDOW computer program.
 - vi Visible Reflectance: Center-of-glazing values, according to NFRC 300.

42. GLASS PRODUCTS, GENERAL

- a. Glazing Publications: Comply with published recommendations of glass product manufacturers and organizations below unless more stringent requirements are indicated. See these publications for glazing terms not otherwise defined in this Section or in referenced standards.
 - i NGA Publications: "Laminated Glazing Reference Manual" and "Glazing Manual."
 - ii AAMA Publications: AAMA GDSG-1, "Glass Design for Sloped Glazing," and AAMA TIR A7, "Sloped Glazing Guidelines."
 - iii IGMA Publication for Sloped Glazing: IGMA TB-3001, "Guidelines for Sloped Glazing."
 - iv IGMA Publication for Insulating Glass: SIGMA TM-3000, "North American Glazing Guidelines for Sealed Insulating Glass Units for Commercial and Residential Use."
- b. Safety Glazing Labeling: Where safety glazing is indicated, permanently mark glazing with certification label of the SGCC the SGCC or another certification agency acceptable to authorities having jurisdiction or manufacturer. Label shall indicate manufacturer's name, type of glass, thickness, and safety glazing standard with which glass complies.
- c. Insulating-Glass Certification Program: Permanently marked either on spacers or on at least one component lite of units with appropriate certification label of the IGCC.

- d. Thickness: Where glass thickness is indicated, it is a minimum. Provide glass that complies with performance requirements and is not less than thickness indicated.
 - i Minimum Glass Thickness for Exterior Lites: 6 mm.
 - ii Thickness of Tinted Glass: Provide same thickness for each tint color indicated throughout Project.
- e. Strength: Where annealed float glass is indicated, provide annealed float glass, heat-strengthened float glass, or fully tempered float glass as needed to comply with "Performance Requirements" Article. Where heat-strengthened float glass is indicated, provide heat-strengthened float glass or fully tempered float glass as needed to comply with "Performance Requirements" Article. Where fully tempered float glass is indicated, provide fully tempered float glass.

43. GLASS PRODUCTS

- a. Clear Annealed Float Glass: ASTM C1036, Type I, Class 1 (clear), Quality-Q3.
 - i Manufacturers: PPG Industries, Corning International or approved equal
- b. Low-Iron Annealed Float Glass: ASTM C1036, Type I, Class I (clear), Quality-Q3; and with visible light transmission of not less than 91 percent and SHGC of not less than 0.87.
 - i Manufacturers: PPG Industries, Corning International or approved equal
- c. Tinted Annealed Float Glass: ASTM C1036, Type I, Class 2 (tinted), Quality-Q3.
 - i Manufacturers: PPG Industries, Corning International or approved equal
- d. Fully Tempered Float Glass: ASTM C1048, Kind FT (fully tempered), Condition A (uncoated) unless otherwise indicated, Type I, Class 1 (clear) or Class 2 (tinted) as indicated, Quality-Q3.
 - i Fabrication Process: By horizontal (roller-hearth) process with roll-wave distortion parallel to bottom edge of glass as installed unless otherwise indicated.
 - ii Fabrication Process: By horizontal (roller-hearth) process with roll-wave distortion parallel to bottom edge of glass as installed unless otherwise indicated.
- e. Pyrolytic-Coated, Low-Maintenance Glass: Clear float glass with coating on first surface having both photocatalytic and hydrophilic properties that act to loosen dirt and to cause water to sheet evenly over the glass instead of beading.
 - i Manufacturers: PPG Industries, Corning International or approved equal
- f. Reflective- and Low-E-Coated Vision Glass: ASTM C1376.
 - i Manufacturers: PPG Industries, Corning International or approved equal
- g. Ceramic-Coated Vision Glass: ASTM C1048, Condition C, Type I, Class 1 (clear) or Class 2 (tinted) as indicated, Quality-Q3; and complying with Specification No. 95-1-31 in NGA's "Engineering Standards Manual."
- h. Ceramic-Coated Spandrel Glass: ASTM C1048, Type I, Condition B, Quality-Q3.
- i. Silicone-Coated Spandrel Glass: ASTM C1048, Type I, Condition C, Quality-Q3.
 - i Manufacturers: PPG Industries, Corning International or approved equal
- j. Fire resistive glass (120 min): TGP FireLite Plus
- k. Reflective- and Low-E-Coated Spandrel Glass: ASTM C1376, Kind CS.
 - i Manufacturers: PPG Industries, Corning International or approved equal

44. LAMINATED GLASS

- a. Windborne-Debris-Impact-Resistant Laminated Glass: Comply with requirements specified above for laminated glass except laminate glass with one of the following to comply with interlayer manufacturer's written instructions:

- i Manufacturers: PPG Industries, Corning International or approved equal
- ii Construction: Laminate glass with polyvinyl butyral interlayer reinforced with polyethylene terephthalate film ionoplast interlayer or cast-in-place and cured-transparent-resin interlayer reinforced with polyethylene terephthalate film to comply with interlayer manufacturer's written instructions.
- iii Interlayer Thickness: Provide thickness not less than that indicated and as needed to comply with requirements.
- iv Interlayer Color: Clear unless otherwise indicated.

45. INSULATING GLASS

- a. Insulating-Glass Units: Factory-assembled units consisting of sealed lites of glass separated by a dehydrated interspace, qualified according to ASTM E2190.
 - i Sealing System: Dual seal, with manufacturer's standard polyisobutylene and polysulfide polyisobutylene and silicone polyisobutylene and hot-melt butyl polyisobutylene and polyurethane primary and secondary sealants.
 - ii Perimeter Spacer: Manufacturer's standard spacer material and construction Aluminum with mill or clear anodic finish Aluminum with black, color anodic finish Aluminum with bronze, color anodic finish Aluminum with powdered metal paint finish in color selected by Architect Galvanized steel Stainless steel Polypropylene-covered stainless steel in color selected by Architect Thermally broken aluminum Nonmetallic laminate Nonmetallic tube Silicone with integral desiccant and vapor barrier.
 - iii Manufacturers: PPG Industries, Corning International or approved equal
 - iv Desiccant: Molecular sieve or silica gel, or a blend of both.

46. GLAZING SEALANTS

- a. General:
 - i Compatibility: Compatible with one another and with other materials they contact, including glass products, seals of insulating-glass units, and glazing channel substrates, under conditions of service and application, as demonstrated by sealant manufacturer based on testing and field experience.
 - ii Suitability: Comply with sealant and glass manufacturers' written instructions for selecting glazing sealants suitable for applications indicated and for conditions existing at time of installation.
 - iii Colors of Exposed Glazing Sealants: As indicated by manufacturer's designations Match Architect's samples As selected by Architect from manufacturer's full range of industry colors.
- b. Neutral-Curing Silicone Glazing Sealant, Class 100/50: Complying with ASTM C920, Type S, Grade NS, Use NT.
 - i Manufacturer: Per glass manufacturer recommendation.
- c. Neutral-Curing Silicone Glazing Sealant, Class 50: Complying with ASTM C920, Type S, Grade NS, Use NT.
 - i Manufacturer: Per glass manufacturer recommendation.
- d. Neutral-Curing Silicone Glazing Sealant, Class 25: Complying with ASTM C920, Type S, Grade NS, Use NT.
 - i Manufacturer: Per glass manufacturer recommendation.

47. GLAZING TAPES

- a. Back-Bedding Mastic Glazing Tapes: Preformed, butyl-based, 100 percent solids elastomeric tape; nonstaining and nonmigrating in contact with nonporous surfaces; with or without spacer rod as recommended in writing by tape and glass manufacturers for application indicated; and complying with ASTM C1281 and AAMA 800 for products indicated below:

- i AAMA 804.3 tape, where indicated.
 - ii AAMA 806.3 tape, for glazing applications in which tape is subject to continuous pressure.
 - iii AAMA 807.3 tape, for glazing applications in which tape is not subject to continuous pressure.
- b. Expanded Cellular Glazing Tapes: Closed-cell, PVC foam tapes; factory coated with adhesive on both surfaces; and complying with AAMA 800 for the following types:
- i AAMA 810.1, Type 1, for glazing applications in which tape acts as primary sealant.
 - ii AAMA 810.1, Type 2, for glazing applications in which tape is used in combination with a full bead of liquid sealant.

48. MISCELLANEOUS GLAZING MATERIALS

- a. General: Provide products of material, size, and shape complying with referenced glazing standard, recommended in writing by manufacturers of glass and other glazing materials for application indicated, and with a proven record of compatibility with surfaces contacted in installation.
- b. Cleaners, Primers, and Sealers: Types recommended by sealant or gasket manufacturer.
- c. Setting Blocks:
- i EPDM Silicone with Shore A durometer hardness of 85, plus or minus 5.
 - ii Type recommended in writing by sealant or glass manufacturer.
- d. Spacers:
- i Neoprene blocks or continuous extrusions of hardness required by glass manufacturer to maintain glass lites in place for installation indicated.
 - ii Type recommended in writing by sealant or glass manufacturer.
- e. Edge Blocks:
- i EPDM Silicone with Shore A durometer hardness per manufacturer's written instructions.
 - ii Type recommended in writing by sealant or glass manufacturer.
- f. Cylindrical Glazing Sealant Backing: ASTM C1330, Type O (open-cell material), of size and density to control glazing sealant depth and otherwise produce optimum glazing sealant performance.

49. FABRICATION OF GLAZING UNITS

- a. Fabricate glazing units in sizes required to fit openings indicated for Project, with edge and face clearances, edge and surface conditions, and bite complying with written instructions of product manufacturer and referenced glazing publications, to comply with system performance requirements.
- i Allow for thermal movements from ambient and surface temperature changes acting on glass framing members and glazing components.
 - 1) Temperature Change: 120 deg F (67 deg C), ambient; 180 deg F (100 deg C), material surfaces.
 - ii Clean-cut or flat-grind vertical edges of butt-glazed monolithic lites to produce square edges with slight chamfers at junctions of edges and faces.
 - iii Grind smooth and polish exposed glass edges and corners.

50. EXAMINATION

- a. Examine framing, glazing channels, and stops, with Installer present, for compliance with the following:
 - i Manufacturing and installation tolerances, including those for size, squareness, and offsets at corners.
 - ii Presence and functioning of weep systems.
 - iii Minimum required face and edge clearances.
 - iv Effective sealing between joints of glass-framing members.
- b. Proceed with installation only after unsatisfactory conditions have been corrected.

51. PREPARATION

- a. Clean glazing channels and other framing members receiving glass immediately before glazing. Remove coatings not firmly bonded to substrates.
- b. Examine glazing units to locate exterior and interior surfaces. Label or mark units as needed so that exterior and interior surfaces are readily identifiable. Do not use materials that leave visible marks in the completed Work.

52. GLAZING, GENERAL

- a. Comply with combined written instructions of manufacturers of glass, sealants, gaskets, and other glazing materials, unless more stringent requirements are indicated, including those in referenced glazing publications.
- b. Protect glass edges from damage during handling and installation. Remove damaged glass from Project site and legally dispose of off Project site. Damaged glass includes glass with edge damage or other imperfections that, when installed, could weaken glass, impair performance, or impair appearance.
- c. Apply primers to joint surfaces where required for adhesion of sealants, as determined by preconstruction testing.
- d. Install setting blocks in sill rabbets, sized and located to comply with referenced glazing publications, unless otherwise required by glass manufacturer. Set blocks in thin course of compatible sealant suitable for heel bead.
- e. Do not exceed edge pressures stipulated by glass manufacturers for installing glass lites.
- f. Provide spacers for glass lites where length plus width is larger than 50 inches (1270 mm).
 - i Locate spacers directly opposite each other on both inside and outside faces of glass. Install correct size and spacing to preserve required face clearances, unless gaskets and glazing tapes are used that have demonstrated ability to maintain required face clearances and to comply with system performance requirements.
 - ii Provide 1/8-inch- (3-mm-) minimum bite of spacers on glass and use thickness equal to sealant width. With glazing tape, use thickness slightly less than final compressed thickness of tape.
- g. Provide edge blocking where indicated or needed to prevent glass lites from moving sideways in glazing channel, as recommended in writing by glass manufacturer and according to requirements in referenced glazing publications.
- h. Set glass lites in each series with uniform pattern, draw, bow, and similar characteristics.
- i. Set glass lites with proper orientation so that coatings face exterior or interior as specified.
- j. Where wedge-shaped gaskets are driven into one side of channel to pressurize sealant or gasket on opposite side, provide adequate anchorage so gasket cannot walk out when installation is subjected to movement.

- k. Square cut wedge-shaped gaskets at corners and install gaskets in a manner recommended by gasket manufacturer to prevent corners from pulling away; seal corner joints and butt joints with sealant recommended in writing by gasket manufacturer.

53. TAPE GLAZING

- a. Position tapes on fixed stops so that, when compressed by glass, their exposed edges are flush with or protrude slightly above sightline of stops.
- b. Install tapes continuously, but not necessarily in one continuous length. Do not stretch tapes to make them fit opening.
- c. Cover vertical framing joints by applying tapes to heads and sills first, then to jambs. Cover horizontal framing joints by applying tapes to jambs, then to heads and sills.
- d. Place joints in tapes at corners of opening with adjoining lengths butted together, not lapped. Seal joints in tapes with compatible sealant approved by tape manufacturer.
- e. Do not remove release paper from tape until right before each glazing unit is installed.
- f. Apply heel bead of elastomeric sealant.
- g. Center glass lites in openings on setting blocks, and press firmly against tape by inserting dense compression gaskets formed and installed to lock in place against faces of removable stops. Start gasket applications at corners and work toward centers of openings.
- h. Apply cap bead of elastomeric sealant over exposed edge of tape.

54. GASKET GLAZING (DRY)

- a. Cut compression gaskets to lengths recommended by gasket manufacturer to fit openings exactly, with allowance for stretch during installation.
- b. Insert soft compression gasket between glass and frame or fixed stop so it is securely in place with joints miter cut and bonded together at corners.
- c. Installation with Drive-in Wedge Gaskets: Center glass lites in openings on setting blocks, and press firmly against soft compression gasket by inserting dense compression gaskets formed and installed to lock in place against faces of removable stops. Start gasket applications at corners and work toward centers of openings. Compress gaskets to produce a weathertight seal without developing bending stresses in glass. Seal gasket joints with sealant recommended in writing by gasket manufacturer.
- d. Installation with Pressure-Glazing Stops: Center glass lites in openings on setting blocks, and press firmly against soft compression gasket. Install dense compression gaskets and pressure-glazing stops, applying pressure uniformly to compression gaskets. Compress gaskets to produce a weathertight seal without developing bending stresses in glass. Seal gasket joints with sealant recommended in writing by gasket manufacturer.
- e. Install gaskets so they protrude past face of glazing stops.

55. SEALANT GLAZING (WET)

- a. Install continuous spacers, or spacers combined with cylindrical sealant backing, between glass lites and glazing stops to maintain glass face clearances and to prevent sealant from extruding into glass channel and blocking weep systems until sealants cure. Secure spacers or spacers and backings in place and in position to control depth of installed sealant relative to edge clearance for optimum sealant performance.
- b. Force sealants into glazing channels to eliminate voids and to ensure complete wetting or bond of sealant to glass and channel surfaces.
- c. Tool exposed surfaces of sealants to provide a substantial wash away from glass.

56. CLEANING AND PROTECTION

- a. Immediately after installation, remove nonpermanent labels and clean surfaces.

- b. Protect glass from contact with contaminating substances resulting from construction operations. Examine glass surfaces adjacent to or below exterior concrete and other masonry surfaces at frequent intervals during construction, but not less than once a month, for buildup of dirt, scum, alkaline deposits, or stains.
 - i If, despite such protection, contaminating substances do contact with glass, remove substances immediately as recommended in writing by glass manufacturer. Remove and replace glass that cannot be cleaned without damage to coatings.
- c. Remove and replace glass that is damaged during construction period.
- d. Wash glass on both exposed surfaces not more than four days before date scheduled for inspections that establish date of Substantial Completion. Wash glass as recommended in writing by glass manufacturer.

57. MONOLITHIC GLASS SCHEDULE

- a. Clear Glass Type: Fully tempered float glass.
 - i Minimum Thickness: 6 mm.
 - ii Safety glazing required.
- b. Low-Iron Glass Type: Fully tempered float glass.
 - i Basis-of-Design Product: PPG / Vitro Glass .
 - ii Minimum Thickness: 6 mm.
 - iii Safety glazing required.
- c. Pyrolytic-Coated, Low-Maintenance Glass Type: Clear annealed heat-strengthened fully tempered float glass.
 - i Basis-of-Design Product: PPG / Vitro Glass.
 - ii Minimum Thickness: 6 mm.
 - iii Safety glazing required.
- d. Tinted Glass Type : Fully tempered float glass.
 - i Basis-of-Design Product: .PPG / Vitro Glass
 - ii Tint Color: Blue Blue-green Bronze Green Gray.
 - iii Minimum Thickness: 6 mm.
 - iv Winter Nighttime U-Factor: 36 maximum.
 - v Summer Daytime U-Factor: 36 maximum.
 - vi Visible Light Transmittance: TBD percent minimum.
 - vii SHGC: 0.64.maximum.
 - viii Safety glazing required.
- e. Ceramic-Coated Vision Glass Type : Heat-strengthened Fully tempered float glass.
- f. Basis-of-Design Product: Vitro Glass.
- g. Glass: Clear Low-iron Tinted float glass.
- h. Ceramic Coating Color and Pattern: As selected by Architect from manufacturer's full range Match Architect's samples .
- i. Minimum Thickness: 6 mm.
- j. Coating Location: Second surface.
- k. Winter Nighttime U-Factor: 36 maximum.
- l. Summer Daytime U-Factor: 36 maximum.

- m. Visible Light Transmittance: percent minimum.
- n. SHGC: 0.64 maximum.
- o. Safety glazing required.
- p. Reflective-Coated Vision Glass Type : Annealed Heat-strengthened Fully tempered float glass.
 - i Basis-of-Design Product: PPG / Vitro Glass.
 - ii Kind CV (coated vision glass), except that Kind CO (coated overhead glass) may be used where lower edge of glass is more than 6 feet (1.8 m) above the adjacent floor level or cannot be approached closer than 10 feet (3.0 m).
 - iii Coating Type: Pyrolytic Sputter-coating (vacuum deposition process).
 - iv Coating Color: Gold Pewter Silver.
 - v Glass: Clear Tinted float glass.
 - vi Tint Color: Blue Blue-green Bronze Green Gray.
 - vii Minimum Thickness: 6 mm.
 - viii Coating Location: First Second surface.
 - ix Outdoor Visible Reflectance: TBD percent maximum.
 - x Winter Nighttime U-Factor: 36 maximum.
 - xi Summer Daytime U-Factor: 36 maximum.
 - xii Visible Light Transmittance: percent minimum.
 - xiii SHGC: 0.64 maximum.
 - xiv Low-Maintenance Coating: Pyrolytic coating on first surface.
 - xv Safety glazing required.
- q. Reflective-Coated Spandrel Glass Type : Heat-strengthened Fully tempered float glass.
 - i Basis-of-Design Product: PPG / Vitro Glass.
 - ii Coating Type: Pyrolytic Sputter-coating (vacuum deposition process).
 - iii Coating Color: Gold Pewter Silver.
 - iv Glass: Clear Low-iron Tinted float glass.
 - v Tint Color: Blue Blue-green Bronze Green Gray.
 - vi Minimum Thickness: 6 mm.
 - vii Coating Location: First Second surface.
 - viii Outdoor Visible Reflectance: TBD percent maximum.
 - ix Winter Nighttime U-Factor: 36 maximum.
 - x Summer Daytime U-Factor: 36 maximum.
 - xi Fallout Resistance: Passes fallout-resistance test in ASTM C1048 for an assembly of glass and adhered reinforcing material.
 - xii Factory apply manufacturer's standard opacifier of the following material to coated on second surface of lites, with resulting products complying with Specification No. 89-1-6 in NGA's "Engineering Standards Manual":
 - 1) Manufacturer's standard opacifier material.
 - 2) Polyester film laminated to glass with solvent-based adhesive.

58. INSULATING-LAMINATED-GLASS SCHEDULE

- a. Clear Insulating, Laminated Glass Type:
 - i Basis-of-Design Product: PPG Solar Cool series
 - ii Overall Unit Thickness: 1-3/16 inch (30 mm) 1 inch (25 mm) 3/4 inch (19 mm).
 - iii Minimum Thickness of Outdoor Lite: 3 mm 4 mm 5 mm 6 mm.
 - iv Outdoor Lite: Clear heat-strengthened fully tempered float glass.
 - v Interspace Content: Air Argon.
 - vi Indoor Lite: Clear laminated glass with two plies of annealed heat-strengthened fully tempered float glass.
 - 1) Minimum Thickness of Each Glass Ply: 3 mm 4 mm 5 mm 6 mm as indicated.
 - 2) Interlayer Thickness: 0.030 inch (0.76 mm) 0.060 inch (1.52 mm) 0.090 inch (2.29 mm).
 - vii Winter Nighttime U-Factor: 36 maximum.
 - viii Summer Daytime U-Factor: 36 maximum.
 - ix SGHC: 0.64 maximum.
 - x Safety glazing required.
- b. Low-E-Coated, Clear Insulating Laminated Glass Type:
 - i Basis-of-Design Product: PPG / Vitro Glass.
 - ii Overall Unit Thickness: 1 inch (25 mm)
 - iii Minimum Thickness of Outdoor Lite: 6 mm.
 - iv Outdoor Lite: Clear heat-strengthened fully tempered float glass.
 - v Interspace Content: Air Argon.
 - vi Indoor Lite: Clear laminated glass with two plies of annealed heat-strengthened fully tempered float glass.
 - 1) Minimum Thickness of Each Glass Ply: 4 mm as indicated.
 - 2) Interlayer Thickness: 0.030 inch (0.76 mm) 0.060 inch (1.52 mm) 0.090 inch (2.29 mm).
 - vii Low-E Coating: Pyrolytic on second Pyrolytic on third Sputtered on second Sputtered on third Pyrolytic or sputtered on second or third surface.
 - viii Winter Nighttime U-Factor: 36 maximum.
 - ix Summer Daytime U-Factor: 36 maximum.
 - x Visible Light Transmittance: percent minimum.
 - xi SGHC: 0.64 maximum.
 - xii Safety glazing required.
- c. Tinted, Insulating Laminated Glass Type :
- d. Basis-of-Design Product: PPG /Vitro Glass.
- e. Overall Unit Thickness: 1-3/16 inch (30 mm) 1 inch (25 mm) 3/4 inch (19 mm).
- f. Minimum Thickness of Outdoor Lite: 3 mm 4 mm 5 mm 6 mm.
- g. Outdoor Lite: Tinted heat-strengthened fully tempered float glass.
- h. Tint Color: Blue Blue-green Bronze Green Gray.
- i. Interspace Content: Air Argon.

- j. Indoor Lite: Clear laminated glass with two plies of annealed heat-strengthened fully tempered float glass.
 - i Minimum Thickness of Each Glass Ply: 4 mm
 - ii Interlayer Thickness: 0.030 inch (0.76 mm) 0.060 inch
- k. Winter Nighttime U-Factor: 36 maximum.
- l. Summer Daytime U-Factor: 36 maximum.
- m. Visible Light Transmittance: percent minimum.
- n. SGHC: 0.64 maximum.
- o. Safety glazing required.
- p. Low-E-Coated, Tinted, Insulating Laminated Glass Type:
 - i Basis-of-Design Product: PPG / Vitro Glass .
 - ii Overall Unit Thickness: 1 inch (25 mm)
 - iii Minimum Thickness of Outdoor Lite: 6 mm.
 - iv Outdoor Lite: Tinted heat-strengthened fully tempered float glass.
 - v Tint Color: Blue Blue-green Bronze Green Gray.
 - vi Interspace Content: Air Argon.
 - vii Indoor Lite: Clear laminated glass with two plies of annealed heat-strengthened fully tempered float glass.
 - 1) Minimum Thickness of Each Glass Ply: 4 mm
 - 2) Interlayer Thickness: 0.030 inch (0.76 mm) 0.060 inch
 - viii Low-E Coating: Pyrolytic on second Pyrolytic on third Sputtered on second Sputtered on third Pyrolytic or sputtered on second or third surface.
 - ix Winter Nighttime U-Factor: 36 maximum.
 - x Summer Daytime U-Factor: 36 maximum.
 - xi Visible Light Transmittance: percent minimum.
 - xii SGHC: 0.64 maximum.
 - xiii Safety glazing required.
- q. Reflective-Coated, Insulating Laminated Glass Type:
 - i Basis-of-Design Product: PPG / Vitro Glass.
 - ii Kind CV (coated vision glass), except that Kind CO (coated overhead glass) may be used where lower edge of glass is more than 6 feet (1.8 m) above the adjacent floor level or cannot be approached closer than 10 feet (3.0 m).
 - iii Coating Type: Pyrolytic Sputter-coating (vacuum deposition process).
 - iv Coating Color: Gold Pewter Silver.
 - v Overall Unit Thickness: 1-3/16 inch (30 mm) 1 inch (25 mm).
 - vi Minimum Thickness of Outdoor Lite: 6 mm.
 - vii Outdoor Lite: Clear heat-strengthened Clear fully tempered Tinted heat-strengthened Tinted fully tempered float glass.
 - viii Tint Color: Blue Blue-green Bronze Green Gray.
 - ix Interspace Content: Air Argon.

- x Indoor Lite: Clear laminated glass with two plies of annealed heat-strengthened fully tempered float glass.
 - 1) Minimum Thickness of Each Glass Ply: 4 mm as indicated.
 - 2) Interlayer Thickness: 0.060 inch (1.52 mm)
- xi Coating Location: First Second Third surface.
- xii Outdoor Visible Reflectance: percent maximum.
- xiii Winter Nighttime U-Factor: 36 maximum.
- xiv Summer Daytime U-Factor: 36 maximum.
- xv Visible Light Transmittance: TBD percent minimum.
- xvi SGHC: 0.64 maximum.
- xvii Low-Maintenance Coating: Pyrolytic coating on first surface.
- xviii Safety glazing required.

D Measurement

The department will measure Aluminum and Glass Curtain Walls in area by the square foot, acceptably completed. The quantity to be paid for will be the sum of the areas of exposed faces at the locations shown on the plans. Area will be determined from measurements taken in the plane of the exposed face of the curtain walls.

E Payment

The department will pay for the measured quantities at the contract unit price under the following bid item:

ITEM NUMBER	DESCRIPTION	UNIT
SPV.0165.03	Aluminum and Glass Curtain Walls	SF

Payment is full compensation for design, shop drawings, samples, mockups, testing, fabrication, and installation.

67. Roofing and Accessories, Item SPV.0165.04.

A Description

A.1 RELATED DOCUMENTS

- a. Drawings and general provisions of the Contract, including General and Supplementary Conditions, apply to this Section.

A.2 SUMMARY

- a. Section Includes:
 - i Standing-seam aluminum roof panels (towers).
 - ii Structural standing seam metal roof panel with open framing (Platform canopy).
 - iii Metal soffit panels.
 - iv Self-adhering Mechanically fastened EPDM roofing system.
 - v Accessory roofing materials.
 - vi Substrate board.
 - vii Vapor retarder.
 - viii Roof insulation.
 - ix Insulation accessories and cover board.

- x Ballast.
 - xi Roof Pads.
 - xii Roof-drainage sheet metal fabrications.
 - xiii Low-slope roof sheet metal fabrications.
 - xiv Steep-slope roof sheet metal fabrications.
 - xv Wall sheet metal fabrications.
 - xvi Miscellaneous sheet metal fabrications.
 - xvii Flanged bellows-type roof expansion joints.
 - xviii Extruded bellows roof expansion joints.
 - xix Aluminum roof expansion joints.
 - xx Preformed foam sealant-type roof expansion joints.
 - xxi Roof curbs for equipment.
 - xxii Pipe and duct support.
 - xxiii Preformed flashing sleeves.
 - xxiv Pipe Portals
 - xxv Pad-type, flat-mounted metal snow guards.
 - xxvi Rail-type, flat mounted snow guards.
- b. Related Sections:
- i "Soffit Panels" for metal panels used in horizontal soffit applications.
 - ii "Snow Guards" for prefabricated devices designed to hold snow on the roof surface, allowing it to melt and drain off slowly.

A.3 Standing Seam Roof Panels

Section Includes:

- Standing-seam aluminum roof panels (towers).
- Structural standing seam metal roof panel with open framing (Platform canopy).

Related Sections:

- "Soffit Panels" for metal panels used in horizontal soffit applications.
- "Snow Guards" for prefabricated devices designed to hold snow on the roof surface, allowing it to melt and drain off slowly.

1. PREINSTALLATION MEETINGS

- a. Preinstallation Conference: Conduct conference at Project site.
- i Meet with Owner, Architect, Owner's insurer if applicable, metal panel Installer, metal panel manufacturer's representative, structural-support Installer, and installers whose work interfaces with or affects metal panels, including installers of roof accessories and roof-mounted equipment.
 - ii Review and finalize construction schedule and verify availability of materials, Installer's personnel, equipment, and facilities needed to make progress and avoid delays.
 - iii Review methods and procedures related to metal panel installation, including manufacturer's written instructions.
 - iv Examine support conditions for compliance with requirements, including alignment between and attachment to structural members.
 - v Review structural loading limitations of deck purlins and rafters during and after roofing.

- vi Review flashings, special details, drainage, penetrations, equipment curbs, and condition of other construction that affect metal panels.
 - vii Review governing regulations and requirements for insurance, certificates, and tests and inspections if applicable.
 - viii Review temporary protection requirements for metal panel systems during and after installation.
 - ix Review procedures for repair of metal panels damaged after installation.
 - x Document proceedings, including corrective measures and actions required, and furnish copy of record to each participant.
2. ACTION SUBMITTALS
- a. Product Data: For each type of product.
 - i Include construction details, material descriptions, dimensions of individual components and profiles, and finishes for each type of panel and accessory.
 - b. Shop Drawings:
 - i Include fabrication and installation layouts of metal panels; details of edge conditions, joints, panel profiles, corners, anchorages, attachment system, trim, flashings, closures, and accessories; and special details.
 - ii Accessories: Include details of the flashing, trim, and anchorage systems, at a scale of not less than 1-1/2 inches per 12 inches (1:10).
 - c. Samples for Initial Selection: For each type of metal panel indicated with factory-applied color finishes.
 - i Include similar Samples of trim and accessories involving color selection.
 - d. Samples for Verification: For each type of exposed finish required, prepared on Samples of size indicated below.
 - i Metal Panels: 12 inches (305 mm) long by actual panel width. Include clips, fasteners, closures, and other metal panel accessories.
3. INFORMATIONAL SUBMITTALS
- a. Qualification Data: For Installer.
 - b. Product Test Reports: For each product, for tests performed by a qualified testing agency.
 - c. Field quality-control reports.
 - d. Sample Warranties: For special warranties.
4. CLOSEOUT SUBMITTALS
- a. Maintenance Data: For metal panels to include in maintenance manuals.
5. QUALITY ASSURANCE
- a. Installer Qualifications: An entity that employs installers and supervisors who are trained and approved by manufacturer.
 - b. UL-Certified, Portable Roll-Forming Equipment: UL-certified, portable roll-forming equipment capable of producing metal panels warranted by manufacturer to be the same as factory-formed products. Maintain UL certification of portable roll-forming equipment for duration of work.
 - c. Mockups: Build mockups to verify selections made under Sample submittals and to demonstrate aesthetic effects and set quality standards for fabrication and installation.
 - i Build mockup of typical roof area and eave, including fascia, and soffit as shown on Drawings; approximately 48 inches (1200 mm) 12 feet (3.5 m) square by full thickness, including attachments, underlayment, and accessories.

- ii Build mockups for typical roof area only, including accessories.
 - 1) Size: 12 feet (3.5 m) long by 6 feet (1.75 m).
 - 2) Each type of exposed seam and seam termination .
- iii Approval of mockups does not constitute approval of deviations from the Contract Documents contained in mockups unless Architect specifically approves such deviations in writing.
- iv Approved mockups may become part of the completed Work if undisturbed at time of Substantial Completion.

6. DELIVERY, STORAGE, AND HANDLING

- a. Deliver components, metal panels, and other manufactured items so as not to be damaged or deformed. Package metal panels for protection during transportation and handling.
- b. Unload, store, and erect metal panels in a manner to prevent bending, warping, twisting, and surface damage.
- c. Stack metal panels horizontally on platforms or pallets, covered with suitable weathertight and ventilated covering. Store metal panels to ensure dryness, with positive slope for drainage of water. Do not store metal panels in contact with other materials that might cause staining, denting, or other surface damage.
- d. Retain strippable protective covering on metal panels during installation.

7. FIELD CONDITIONS

- a. Weather Limitations: Proceed with installation only when existing and forecasted weather conditions permit assembly of metal panels to be performed according to manufacturers' written instructions and warranty requirements.

8. COORDINATION

- a. Coordinate sizes and locations of roof curbs, equipment supports, and roof penetrations with actual equipment provided.
- b. Coordinate metal panel installation with rain drainage work, flashing, trim, construction of soffits, and other adjoining work to provide a leakproof, secure, and noncorrosive installation.

9. WARRANTY

- a. Special Warranty: Manufacturer's standard form in which manufacturer agrees to repair or replace components of metal panel systems that fail in materials or workmanship within specified warranty period.
 - i Failures include, but are not limited to, the following:
 - 1) Structural failures including rupturing, cracking, or puncturing.
 - 2) Deterioration of metals and other materials beyond normal weathering.
 - b. Warranty Period: Two years from date of Substantial Completion.
 - c. Special Warranty on Panel Finishes: Manufacturer's standard form in which manufacturer agrees to repair finish or replace metal panels that show evidence of deterioration of factory-applied finishes within specified warranty period.
 - i Exposed Panel Finish: Deterioration includes, but is not limited to, the following:
 - 1) Color fading more than 5 Delta E units when tested according to ASTM D2244.
 - 2) Chalking in excess of a No. 8 rating when tested according to ASTM D4214.
 - 3) Cracking, checking, peeling, or failure of paint to adhere to bare metal.
 - ii Finish Warranty Period: 10 years from date of Substantial Completion.

- d. Special Weathertightness Warranty: Manufacturer's standard form in which manufacturer agrees to repair or replace standing-seam metal roof panel assemblies that fail to remain weathertight, including leaks, within specified warranty period.
 - i. Warranty Period: 20 years from date of Substantial Completion.

A.4 Metal Soffit Panels

1. RELATED DOCUMENTS
 - a. Drawings and general provisions of the Contract, including General and Supplementary Conditions, apply to this Section.
2. SUMMARY
 - a. Section Includes:
 - i. Metal soffit panels.
 - b. Related Sections:
 - i. "Formed Metal Roof Panels" for lap-seam metal roof panels.
3. PREINSTALLATION MEETINGS
 - a. Preinstallation Conference: Conduct conference at Project site.
4. ACTION SUBMITTALS
 - a. Product Data: For each type of product.
 - i. Include construction details, material descriptions, dimensions of individual components and profiles, and finishes for each type of panel and accessory.
 - b. Shop Drawings:
 - i. Include fabrication and installation layouts of metal panels; details of edge conditions, joints, panel profiles, corners, anchorages, attachment system, trim, flashings, closures, and accessories; and special details.
 - ii. Accessories: Include details of flashing, trim, and anchorage systems, at a scale of not less than 1-1/2 inches per 12 inches (1:10).
 - c. Samples for Initial Selection: For each type of metal panel indicated with factory-applied color finishes.
 - i. Include similar Samples of trim and accessories involving color selection.
 - d. Samples for Verification: For each type of exposed finish required, prepared on Samples of size indicated below:
 - i. Metal Panels: 12 inches (305 mm) long by actual panel width. Include fasteners, closures, and other metal panel accessories.
5. INFORMATIONAL SUBMITTALS
 - a. Qualification Data: For Installer.
 - b. Product Test Reports: For each product, tests performed by a qualified testing agency.
 - c. Sample Warranties: For special warranties.
6. CLOSEOUT SUBMITTALS
 - a. Maintenance Data: For metal panels to include in maintenance manuals.
7. QUALITY ASSURANCE
 - a. Installer Qualifications: An entity that employs installers and supervisors who are trained and approved by manufacturer.

- b. UL-Certified, Portable Roll-Forming Equipment: UL-certified, portable roll-forming equipment capable of producing metal panels warranted by manufacturer to be the same as factory-formed products. Maintain UL certification of portable roll-forming equipment for duration of work.
- c. Mockups: Build mockups to verify selections made under Sample submittals and to demonstrate aesthetic effects and set quality standards for fabrication and installation.
 - i. Build mockup of typical roof eave, including fascia, and soffit as shown on Drawings; approximately four panels wide by full eave width, including attachments and accessories.
 - ii. Approval of mockups does not constitute approval of deviations from the Contract Documents contained in mockups unless Architect specifically approves such deviations in writing.
 - iii. Subject to compliance with requirements, approved mockups may become part of the completed Work if undisturbed at time of Substantial Completion.

8. DELIVERY, STORAGE, AND HANDLING

- a. Deliver components, metal panels, and other manufactured items so as not to be damaged or deformed. Package metal panels for protection during transportation and handling.
- b. Unload, store, and erect metal panels in a manner to prevent bending, warping, twisting, and surface damage.
- c. Stack metal panels horizontally on platforms or pallets, covered with suitable weathertight and ventilated covering. Store metal panels to ensure dryness, with positive slope for drainage of water. Do not store metal panels in contact with other materials that might cause staining, denting, or other surface damage.
- d. Retain strippable protective covering on metal panels during installation.
- e. Copper Panels: Wear gloves when handling to prevent fingerprints and soiling of surface.

9. FIELD CONDITIONS

- a. Weather Limitations: Proceed with installation only when existing and forecasted weather conditions permit assembly of metal panels to be performed according to manufacturers' written instructions and warranty requirements.

10. COORDINATION

- a. Coordinate metal panel installation with rain drainage work, flashing, trim, construction of walls, and other adjoining work to provide a leakproof, secure, and noncorrosive installation.

11. WARRANTY

- a. Special Warranty: Manufacturer's standard form in which manufacturer agrees to repair or replace components of metal panel systems that fail in materials or workmanship within specified warranty period.
 - i. Failures include, but are not limited to, the following:
 - 1) Structural failures including rupturing, cracking, or puncturing.
 - 2) Deterioration of metals and other materials beyond normal weathering.
 - ii. Warranty Period: Two years from date of Substantial Completion.
- b. Special Warranty on Panel Finishes: Manufacturer's standard form in which manufacturer agrees to repair finish or replace metal panels that show evidence of deterioration of factory-applied finishes within specified warranty period.
 - i. Exposed Panel Finish: Deterioration includes, but is not limited to, the following:
 - 1) Color fading more than 5 Delta E units when tested according to ASTM D2244.
 - 2) Chalking in excess of a No. 8 rating when tested according to ASTM D4214.

- 3) Cracking, checking, peeling, or failure of paint to adhere to bare metal.
- ii Finish Warranty Period: 10 years from date of Substantial Completion.

A.5 EPDM Roofing

1. SUMMARY

a. Section Includes:

- i Self-adhering Mechanically fastened EPDM roofing system.
- ii Accessory roofing materials.
- iii Substrate board.
- iv Vapor retarder.
- v Roof insulation.
- vi Insulation accessories and cover board.
- vii Asphalt materials.
- viii Ballast.
- ix Walkways.

b. Related Requirements:

- i "Rough Carpentry for wood nailers, curbs, and blocking and for wood-based, structural-use roof deck panels.
- ii "Sheathing" for wood-based, structural-use roof deck panels.
- iii "Thermal Insulation" for insulation beneath the roof deck.
- iv "Sheet Metal Flashing and Trim" for metal roof flashings and counterflashings.
- v "Roof Specialties" for manufactured copings and roof edge flashings.
- vi "Manufactured Roof Expansion Joints" for manufactured roof expansion-joint assemblies.
- vii "Joint Sealants" for joint sealants, joint fillers, and joint preparation.
- viii "Storm Drainage Piping Specialties" for roof drains.

2. DEFINITIONS

- a. Roofing Terminology: Definitions in ASTM D1079 and glossary of NRCA's "The NRCA Roofing Manual: Membrane Roof Systems" apply to work of this Section.

3. PREINSTALLATION MEETINGS

- a. Preliminary Roofing Conference: Before starting roof deck construction, conduct conference at Project site.
 - i Meet with Owner, Architect, Construction Manager, Owner's insurer if applicable, testing and inspecting agency representative, roofing Installer, roofing system manufacturer's representative, deck Installer, air barrier Installer, and installers whose work interfaces with or affects roofing, including installers of roof accessories and roof-mounted equipment.
 - ii Review methods and procedures related to roofing installation, including manufacturer's written instructions.
 - iii Review and finalize construction schedule, and verify availability of materials, Installer's personnel, equipment, and facilities needed to make progress and avoid delays.
 - iv Review deck substrate requirements for conditions and finishes, including flatness and fastening.
 - v Review structural loading limitations of roof deck during and after roofing.

- vi Review base flashings, special roofing details, roof drainage, roof penetrations, equipment curbs, and condition of other construction that affects roofing system.
 - vii Review governing regulations and requirements for insurance and certificates if applicable.
 - viii Review temporary protection requirements for roofing system during and after installation.
 - ix Review roof observation and repair procedures after roofing installation.
- b. Preinstallation Roofing Conference: Conduct conference at Project site.
- i Meet with Owner, Architect, Construction Manager, Owner's insurer if applicable, testing and inspecting agency representative, roofing Installer, roofing system manufacturer's representative, deck Installer, air barrier Installer, and installers whose work interfaces with or affects roofing, including installers of roof accessories and roof-mounted equipment.
 - ii Review methods and procedures related to roofing installation, including manufacturer's written instructions.
 - iii Review and finalize construction schedule, and verify availability of materials, Installer's personnel, equipment, and facilities needed to make progress and avoid delays.
 - iv Examine deck substrate conditions and finishes, including flatness and fastening.
 - v Review structural loading limitations of roof deck during and after roofing.
 - vi Review base flashings, special roofing details, roof drainage, roof penetrations, equipment curbs, and condition of other construction that affects roofing system.
 - vii Review governing regulations and requirements for insurance and certificates if applicable.
 - viii Review temporary protection requirements for roofing system during and after installation.
 - ix Review roof observation and repair procedures after roofing installation.

4. ACTION SUBMITTALS

- a. Product Data: For each type of product.
 - i For insulation and roof system component fasteners, include copy of SPRI's Directory of Roof Assemblies listing.
- b. Shop Drawings: Include roof plans, sections, details, and attachments to other work, including the following:
 - i Layout and thickness of insulation.
 - ii Base flashings and membrane terminations.
 - iii Flashing details at penetrations.
 - iv Tapered insulation, thickness, and slopes.
 - v Roof plan showing orientation of steel roof deck and orientation of roof membrane and fastening spacings and patterns for mechanically fastened roofing system.
 - vi Insulation fastening patterns for corner, perimeter, and field-of-roof locations.
 - vii Tie-in with air barrier.
- c. Samples for Verification: For the following products:
 - i Roof membrane and flashings of color required.
 - ii Aggregate surfacing material in gradation and color required.

- iii Roof paver, full sized, in each color and texture required.
 - iv Walkway pads or rolls, of color required.
 - d. Wind Uplift Resistance Submittal: For roofing system, indicating compliance with wind uplift performance requirements.
- 5. INFORMATIONAL SUBMITTALS
 - a. Qualification Data: For Installer and manufacturer.
 - b. Manufacturer Certificates:
 - i Performance Requirement Certificate: Signed by roof membrane manufacturer, certifying that roofing system complies with requirements specified in "Performance Requirements" Article.
 - 1) Submit evidence of complying with performance requirements.
 - ii Special Warranty Certificate: Signed by roof membrane manufacturer, certifying that all materials supplied under this Section are acceptable for special warranty.
 - c. Product Test Reports: For components of roof membrane and insulation, for tests performed by a qualified testing agency, indicating compliance with specified requirements.
 - d. Evaluation Reports: For components of roofing system, from ICC-ES.
 - i Field Test Reports:
 - ii Concrete internal relative humidity test reports.
 - iii Fastener-pullout test results and manufacturer's revised requirements for fastener patterns.
 - e. Field quality-control reports.
 - f. Sample Warranties: For manufacturer's special warranties.
- 6. CLOSEOUT SUBMITTALS
 - a. Maintenance Data: For roofing system to include in maintenance manuals.
 - b. Certified statement from existing roof membrane manufacturer stating that existing roof warranty has not been affected by Work performed under this Section.
- 7. QUALITY ASSURANCE
 - a. Qualifications:
 - i Manufacturers: A qualified manufacturer that is UL listed listed in SPRI's Directory of Roof Assemblies for roofing system identical to that used for this Project.
 - ii Installers: A qualified firm that is approved, authorized, or licensed by roofing system manufacturer to install manufacturer's product and that is eligible to receive manufacturer's special warranty.
- 8. DELIVERY, STORAGE, AND HANDLING
 - a. Deliver roofing materials to Project site in original containers with seals unbroken and labeled with manufacturer's name, product brand name and type, date of manufacture, approval or listing agency markings, and directions for storing and mixing with other components.
 - b. Store liquid materials in their original undamaged containers in a clean, dry, protected location and within the temperature range required by roofing system manufacturer. Protect stored liquid material from direct sunlight.
 - i Discard and legally dispose of liquid material that cannot be applied within its stated shelf life.
 - c. Protect roof insulation materials from physical damage and from deterioration by sunlight, moisture, soiling, and other sources. Store in a dry location. Comply with insulation manufacturer's written instructions for handling, storing, and protecting during installation.

- d. Handle and store roofing materials, and place equipment in a manner to avoid permanent deflection of deck.

9. FIELD CONDITIONS

- a. Weather Limitations: Proceed with installation only when existing and forecasted weather conditions permit roofing system to be installed according to manufacturer's written instructions and warranty requirements.

10. WARRANTY

- a. Special Warranty: Manufacturer agrees to repair or replace components of roofing system that fail in materials or workmanship within specified warranty period.
 - i Special warranty includes roof membrane, base flashings, roof insulation, fasteners, cover boards, substrate board, roof pavers, and other components of roofing system.
 - ii Warranty Period: 20 years from Date of Substantial Completion.
- b. Special Project Warranty: Submit roofing Installer's warranty, on warranty form at end of this Section, signed by Installer, covering the Work of this Section, including all components of roofing system such as roof membrane, base flashing, roof insulation, fasteners, cover boards, substrate boards, vapor retarders, roof pavers, and walkway products, for the following warranty period:
 - i Warranty Period: One year from Date of Substantial Completion.

A.6 Sheet Metal Flashing and Trim

1. SUMMARY

- a. Section Includes:
 - i Roof-drainage sheet metal fabrications.
 - ii Low-slope roof sheet metal fabrications.
 - iii Steep-slope roof sheet metal fabrications.
 - iv Wall sheet metal fabrications.
 - v Miscellaneous sheet metal fabrications.

2. COORDINATION

- a. Coordinate sheet metal flashing and trim layout and seams with sizes and locations of penetrations to be flashed, and joints and seams in adjacent materials.
- b. Coordinate sheet metal flashing and trim installation with adjoining roofing and wall materials, joints, and seams to provide leakproof, secure, and noncorrosive installation.

3. PREINSTALLATION MEETINGS

- a. Preinstallation Conference: Conduct conference at Project site.
 - i Review construction schedule. Verify availability of materials, Installer's personnel, equipment, and facilities needed to make progress and avoid delays.
 - ii Review special roof details, roof drainage, roof-penetration flashing, equipment curbs, and condition of other construction that affect sheet metal flashing and trim.
 - iii Review requirements for insurance and certificates if applicable.
 - iv Review sheet metal flashing observation and repair procedures after flashing installation.

4. ACTION SUBMITTALS

- a. Product Data: For each of the following
 - i Underlayment materials.
 - ii Elastomeric sealant.
 - iii Butyl sealant.
 - iv Epoxy seam sealer.
- b. Sustainable Design Submittals:
- c. Shop Drawings: For sheet metal flashing and trim.
 - i Include plans, elevations, sections, and attachment details.
 - ii Detail fabrication and installation layouts, expansion-joint locations, and keyed details. Distinguish between shop- and field-assembled Work.
 - iii Include identification of material, thickness, weight, and finish for each item and location in Project.
 - iv Include details for forming, including profiles, shapes, seams, and dimensions.
 - v Include details for joining, supporting, and securing, including layout and spacing of fasteners, cleats, clips, and other attachments. Include pattern of seams.
 - vi Include details of termination points and assemblies.
 - vii Include details of expansion joints and expansion-joint covers, including showing direction of expansion and contraction from fixed points.
 - viii Include details of roof-penetration flashing.
 - ix Include details of edge conditions, including eaves, ridges, valleys, rakes, crickets, flashings, and counterflashings.
 - x Include details of special conditions.
 - xi Include details of connections to adjoining work.
 - xii Detail formed flashing and trim at scale of not less than 1-1/2 inches per 12 inches (1:10)
 - xiii Retain "Samples" Paragraph below for single-stage Samples, with a subordinate list if applicable. Retain "Samples for Initial Selection" and "Samples for Verification" paragraphs for two-stage Samples.
- d. Samples: For each exposed product and for each color and texture specified, 12 inches (300 mm) long by actual width.
- e. Samples for Initial Selection: For each type of sheet metal and accessory indicated with factory-applied finishes.
- f. Samples for Verification: For each type of exposed finish.
 - i Sheet Metal Flashing: 12 inches (300 mm) long by actual width of unit, including finished seam and in required profile. Include fasteners, cleats, clips, closures, and other attachments.
 - ii Trim, Metal Closures, Expansion Joints, Joint Intersections, and Miscellaneous Fabrications: 12 inches (300 mm) long and in required profile. Include fasteners and other exposed accessories.
 - iii Unit-Type Accessories and Miscellaneous Materials: Full-size Sample.
 - iv Anodized Aluminum Samples: Samples to show full range to be expected for each color required.

5. INFORMATIONAL SUBMITTALS

- a. Qualification Data: For fabricator.
- b. Product Certificates: For each type of coping and roof edge flashing that is ANSI/SPRI/FM 4435/ES-1 tested and FM Approvals approved.
- c. Product Test Reports: For each product, for tests performed by a qualified testing agency.
- d. Evaluation Reports: For copings and roof edge flashing, from an agency acceptable to authority having jurisdiction ICC-ES showing compliance with ANSI/SPRI/FM 4435/ES-1.
- e. Sample Warranty: For special warranty.

6. CLOSEOUT SUBMITTALS

- a. Maintenance Data: For sheet metal flashing and trim, and its accessories, to include in maintenance manuals.
- b. Special warranty.

7. QUALITY ASSURANCE

- a. Fabricator Qualifications: Employs skilled workers who custom fabricate sheet metal flashing and trim similar to that required for this Project and whose products have a record of successful in-service performance.
 - i For copings and roof edge flashings that are ANSI/SPRI/FM 4435/ES-1 tested and FM Approvals approved, shop is to be listed as able to fabricate required details as tested and approved.
- b. Mockups: Build mockups to verify selections made under Sample submittals, to demonstrate aesthetic effects, and to set quality standards for fabrication and installation.
 - i Build mockup of typical roof edge eave, including built-in gutter fascia trim apron flashing, approximately 10 feet (3.0 m) long, including supporting construction cleats, seams, attachments, underlayment, and accessories.
 - ii Approval of mockups does not constitute approval of deviations from the Contract Documents contained in mockups unless Owner specifically approves such deviations in writing.
 - iii Subject to compliance with requirements, approved mockups may become part of the completed Work if undisturbed at time of Substantial Completion.

8. DELIVERY, STORAGE, AND HANDLING

- a. Do not store sheet metal flashing and trim materials in contact with other materials that might cause staining, denting, or other surface damage.
 - i Store sheet metal flashing and trim materials away from uncured concrete and masonry.
 - ii Protect stored sheet metal flashing and trim from contact with water.
- b. Protect strippable protective covering on sheet metal flashing and trim from exposure to sunlight and high humidity, except to extent necessary for period of sheet metal flashing and trim installation.

9. WARRANTY

- a. Special Warranty on Finishes: Manufacturer agrees to repair finish or replace sheet metal flashing and trim that shows evidence of deterioration of factory-applied finishes within specified warranty period.
 - i Exposed Panel Finish: Deterioration includes, but is not limited to, the following:
 - 1) Color fading more than 5 Delta E units when tested according to ASTM D2244.
 - 2) Chalking in excess of a No. 8 rating when tested according to ASTM D4214.

- 3) Cracking, checking, peeling, or failure of paint to adhere to bare metal.
- ii Finish Warranty Period: 20 years from date of Substantial Completion.

A.7 Manufactured Roof Expansion Joints

1. RELATED DOCUMENTS

- a. Drawings and general provisions of the Contract, including General and Supplementary Conditions, apply to this Section.

2. SUMMARY

a. Section Includes:

- i Flanged bellows-type roof expansion joints.
- ii Extruded bellows roof expansion joints.
- iii Aluminum roof expansion joints.
- iv Preformed foam sealant-type roof expansion joints.

b. Related Requirements:

- i "Rough Carpentry" for wooden curbs or cants for mounting roof expansion joints.
- ii "Sheet Metal Flashing and Trim" for shop- and field-fabricated sheet metal expansion-joint systems, flashing, and other sheet metal items.
- iii "Roof Accessories" for manufactured and prefabricated metal roof curbs.

3. PREINSTALLATION MEETINGS

- a. Preinstallation Conference: Conduct conference at Project site.

4. ACTION SUBMITTALS

- a. Product Data: For each type of product.

- b. Shop Drawings: For roof expansion joints.

- i Include plans, elevations, sections, and attachment details.
- ii Include details of splices, intersections, transitions, fittings, method of field assembly, and location and size of each field splice.
- iii Provide isometric drawings of intersections, terminations, changes in joint direction or planes, and transition to other expansion joint systems depicting how components interconnect with each other and adjacent construction to allow movement and achieve waterproof continuity.

- c. Samples: For each exposed product and for each color specified, 6 inches (150 mm) in size.

5. INFORMATIONAL SUBMITTALS

- a. Qualification Data: For Installer.

- b. Product Test Reports: For each fire-barrier provided as part of a roof-expansion-joint assembly, for tests performed by a qualified testing agency.

- c. Sample Warranties: For special warranties.

6. QUALITY ASSURANCE

- a. Installer Qualifications: Installer of roofing membrane.

7. WARRANTY

- a. Special Warranty: Manufacturer agrees to repair or replace roof expansion joints and components that leak, deteriorate beyond normal weathering, or otherwise fail in materials or workmanship within specified warranty period.

- i Warranty Period: Two years from date of Substantial Completion.

- b. Special Warranty on Painted Finishes: Manufacturer's standard form in which manufacturer agrees to repair finish or replace roof expansion joints that show evidence of deterioration of factory-applied finishes within specified warranty period.
 - i Fluoropolymer Finish: Deterioration includes, but is not limited to, the following:
 - 1) Color fading more than 5 Delta E units when tested according to ASTM D2244.
 - 2) Chalking in excess of a No. 8 rating when tested according to ASTM D4214.
 - 3) Cracking, checking, peeling, or failure of paint to adhere to bare metal.
 - ii Warranty Period: 20 years from date of Substantial Completion.

A.8 Roof Accessories

1. SUMMARY

a. Section Includes:

- i Roof curbs for equipment.
- ii Pipe and duct supports.
- iii Preformed flashing sleeves.
- iv Pipe Portals

b. Related Requirements:

- i "Metal Fabrications" for metal vertical ladders, ships' ladders, and stairs for access to roof hatches.
- ii "Pipe and Tube Railings" for safety railing systems not attached to roof-hatch curbs.
- iii "Sheet Metal Roofing" for shop- and field-formed roof curbs and snow guards for sheet metal roofing.
- iv "Sheet Metal Flashing and Trim" for shop- and field-formed metal flashing, roof-drainage systems, roof expansion-joint covers, and miscellaneous sheet metal trim and accessories.
- v "Manufactured Roof Expansion Joints" for manufactured roof expansion-joint covers.
- vi "Snow Guards" for snow guards.

2. COORDINATION

- a. Coordinate layout and installation of roof accessories with roofing membrane and base flashing and interfacing and adjoining construction to provide a leakproof, weathertight, secure, and noncorrosive installation.
- b. Coordinate dimensions with rough-in information or Shop Drawings of equipment to be supported.

3. ACTION SUBMITTALS

a. Product Data: For each type of roof accessory.

- i Include construction details, material descriptions, dimensions of individual components and profiles, and finishes.

b. Shop Drawings: For roof accessories.

- i Include plans, elevations, keyed details, and attachments to other work. Indicate dimensions, loadings, and special conditions. Distinguish between plant- and field-assembled work.

- c. Samples: For each exposed product and for each color and texture specified, prepared on Samples of size to adequately show color.

- d. Delegated Design Submittals: For roof curbs indicated to comply with performance requirements and design criteria, including analysis data signed and sealed by the qualified professional engineer responsible for their preparation.
 - i Detail mounting, securing, and flashing of roof-mounted items to roof structure. Indicate coordinating requirements with roof membrane system.
 - ii Wind-Restraint Details: Detail fabrication and attachment of wind restraints. Show anchorage details and indicate quantity, diameter, and depth of penetration of anchors.

4. INFORMATIONAL SUBMITTALS

- a. Coordination Drawings: Roof plans, drawn to scale, and coordinating penetrations and roof-mounted items. Show the following:
 - i Size and location of roof accessories specified in this Section.
 - ii Method of attaching roof accessories to roof or building structure.
 - iii Other roof-mounted items including mechanical and electrical equipment, ductwork, piping, and conduit.
 - iv Required clearances.
- b. Sample Warranties: For manufacturer's special warranties.

5. CLOSEOUT SUBMITTALS

- a. Operation and Maintenance Data: For roof accessories to include in operation and maintenance manuals.

6. WARRANTY

- a. Special Warranty on Painted Finishes: Manufacturer's standard form in which manufacturer agrees to repair finishes or replace roof accessories that show evidence of deterioration of factory-applied finishes within specified warranty period.
 - i Fluoropolymer Finish: Deterioration includes, but is not limited to, the following:
 - 1) Color fading more than 5 Delta E units when tested according to ASTM D2244.
 - 2) Chalking in excess of a No. 8 rating when tested according to ASTM D4214.
 - 3) Cracking, checking, peeling, or failure of paint to adhere to bare metal.
 - ii Finish Warranty Period: 20 years from date of Substantial Completion.

A.9 Snow Guards

1. RELATED DOCUMENTS

- a. Drawings and general provisions of the Contract, including General and Supplementary Conditions, apply to this Section.

2. SUMMARY

- a. Section Includes:
 - i Pad-type, flat-mounted metal snow guards.
 - ii Rail-type, flat mounted snow guards.

3. ACTION SUBMITTALS

- a. Product Data: For each type of product, include construction details, material descriptions, dimensions of individual components and profiles, and finishes.
- b. Shop Drawings: Include roof plans showing layouts and attachment details of snow guards.
 - i Include details of rail-type snow guards.

- c. Samples:
 - 1) Pad-Type Snow Guards: Full-size unit with installation hardware.
 - 2) For units with factory-applied finishes, submit manufacturer's standard color selections specified color.
 - i Rail-Type Snow Guards: Bracket, 12-inch- (300-mm-) long rail, and installation hardware.
 - 1) For units with factory-applied finishes, submit manufacturer's standard color selections specified color.
- d. Delegated-Design Submittal: For snow guards, include analysis reports signed and sealed by the qualified professional engineer responsible for their preparation.
 - i Include calculation of number and location of snow guards.

4. INFORMATIONAL SUBMITTALS

- a. Qualification Data: For professional engineer's experience with providing delegated design engineering services of the kind indicated, including documentation that the engineer is licensed in the jurisdiction state in which the Project is located.
- b. Product Test Reports: For each type of snow guard, for tests performed by a qualified testing agency, indicating load at failure of attachment to roof system identical to roof system used on this Project.

5. FIELD CONDITIONS

- a. Weather Limitations: Proceed with installation only when existing and forecasted weather conditions permit adhesive-mounted snow guards to be installed, and adhesive cured, according to adhesive manufacturer's written instructions.

B Materials

B.1 Standing Seam Roof Panels

1. PERFORMANCE REQUIREMENTS

- a. Energy Performance: Provide roof panels that are listed on the EPA/DOE's ENERGY STAR "Roof Product List" for low steep-slope roof products.
- b. Energy Performance: Provide roof panels according to one of the following when tested according to CRRC-1:
 - i Three-year, aged solar reflectance of not less than 0.55 and emissivity of not less than 0.75
 - ii Three-year, aged Solar Reflectance Index of not less than 64 when calculated according to ASTM E1980.
- c. Structural Performance: Provide metal panel systems capable of withstanding the effects of the following loads, based on testing according to ASTM E1592:
 - i Wind Loads: As indicated on Drawings.
 - ii Other Design Loads: As indicated on Drawings
 - iii Deflection Limits: For wind loads, no greater than $1/180$ of the span.
- d. Air Infiltration: Air leakage of not more than 0.06 cfm/sq. ft. (0.3 L/s per sq. m) when tested according to ASTM E1680 or ASTM E283 at the following test-pressure difference:
 - i Test-Pressure Difference: 1.57 lbf/sq. ft. (75 Pa) 6.24 lbf/sq. ft. (300 Pa).
- e. Water Penetration under Static Pressure: No water penetration when tested according to ASTM E1646 or ASTM E331 at the following test-pressure difference:
 - i Test-Pressure Difference: 2.86 lbf/sq. ft. (137 Pa) 6.24 lbf/sq. ft. (300 Pa).

- f. Hydrostatic-Head Resistance: No water penetration when tested according to ASTM E2140.
- g. Wind-Uplift Resistance: Provide metal roof panel assemblies that comply with UL 580 for wind-uplift-resistance class indicated.
 - i Uplift Rating: UL 30 UL 60 UL 90.
- h. FM Global Listing: Provide metal roof panels and component materials that comply with requirements in FM Global 4471 as part of a panel roofing system and that are listed in FM Global's "Approval Guide" for Class 1 or noncombustible construction, as applicable. Identify materials with FM Global markings.
 - i Fire/Windstorm Classification: Class 1A- 60 75 90 105 120 .
 - ii Hail Resistance: MH SH.
- i. Thermal Movements: Allow for thermal movements from ambient and surface temperature changes by preventing buckling, opening of joints, overstressing of components, failure of joint sealants, failure of connections, and other detrimental effects. Base calculations on surface temperatures of materials due to both solar heat gain and nighttime-sky heat loss.
 - i Temperature Change (Range): 120 deg F (67 deg C), ambient; 180 deg F (100 deg C), material surfaces .

2. STANDING-SEAM METAL ROOF PANELS

- a. Provide factory-formed metal roof panels designed to be installed by lapping and interconnecting raised side edges of adjacent panels with joint type indicated and mechanically attaching panels to supports using concealed clips in side laps. Include clips, cleats, pressure plates, and accessories required for weathertight installation.
 - i Steel Panel Systems: Unless more stringent requirements are indicated, comply with ASTM E1514.
 - ii Aluminum Panel Systems: Unless more stringent requirements are indicated, comply with ASTM E1637.
- b. Vertical-Rib, Snap-Joint, Standing-Seam Metal Roof Panels Formed with vertical ribs at panel edges and intermediate stiffening ribs symmetrically spaced a flat pan between ribs; designed for sequential installation by mechanically attaching panels to supports using concealed clips located under one side of panels, engaging opposite edge of adjacent panels, and snapping panels together.
 - i Manufacturer: FABRAL, MS Metal Sales manufacturing or approved equal.
 - ii Metallic-Coated Steel Sheet: Zinc-coated (galvanized) steel sheet complying with ASTM A653/A653M, G90 (Z275) coating designation, or aluminum-zinc alloy-coated steel sheet complying with ASTM A792/A792M, Class AZ50 (Class AZM150) coating designation; structural quality. Prepainted by the coil-coating process to comply with ASTM A755/A755M.
 - 1) Nominal Thickness: 0.022 inch (0.56 mm) 0.028 inch (0.71 mm) 0.034 inch (0.86 mm) 0.040 inch (1.02 mm) 0.052 inch (1.32 mm).
 - 2) Exterior Finish: Two-coat fluoropolymer Three-coat fluoropolymer Mica fluoropolymer Metallic fluoropolymer FEVE fluoropolymer Siliconized polyester .
 - 3) Color: As indicated by manufacturer's designations Match Architect's samples As selected by Architect from manufacturer's full range.
 - iii Aluminum Sheet: Coil-coated sheet, ASTM B209 (ASTM B209M), alloy as standard with manufacturer, with temper as required to suit forming operations and structural performance required.
 - 1) Thickness: 0.032 inch (0.81 mm) 0.040 inch (1.02 mm).
 - 2) Surface: Smooth, flat Embossed finish.

- 3) Exterior Finish: Two-coat fluoropolymer Clear anodized Color anodized .
 - 4) Color: As indicated by manufacturer's designations Match Architect's samples As selected by Architect from manufacturer's full range.
- iv Clips: One-piece fixed to accommodate thermal movement.
- 1) Material: 0.028-inch- (0.71-mm-) 0.064-inch- (1.63-mm-) nominal thickness, zinc-coated (galvanized) or aluminum-zinc alloy-coated steel sheet.
 - 2) Material: 0.0250-inch- (0.635-mm-) 0.0625-inch- (1.587-mm-) thick, stainless steel sheet.
- v Panel Coverage: 14 inches (356 mm) 16 inches (406 mm)
- vi Panel Height: 20 GA, 22 GA
- c. Vertical-Rib, Seamed-Joint, Standing-Seam Metal Roof Panels: Formed with vertical ribs at panel edges and intermediate stiffening ribs symmetrically spaced a flat pan between ribs; designed for sequential installation by mechanically attaching panels to supports using concealed clips located under one side of panels, engaging opposite edge of adjacent panels, and mechanically seaming panels together.
- i Manufacturer: FABRAL, MS Metal Sales manufacturing or approved equal
 - ii Metallic-Coated Steel Sheet: Zinc-coated (galvanized) steel sheet complying with ASTM A653/A653M, G90 (Z275) coating designation, or aluminum-zinc alloy-coated steel sheet complying with ASTM A792/A792M, Class AZ50 (Class AZM150) coating designation; structural quality. Prepainted by the coil-coating process to comply with ASTM A755/A755M.
 - 1) Nominal Thickness: 0.022 inch (0.56 mm) 0.028 inch (0.71 mm) 0.034 inch (0.86 mm) 0.040 inch (1.02 mm) 0.052 inch (1.32 mm).
 - 2) Exterior Finish: Two-coat fluoropolymer Three-coat fluoropolymer Mica fluoropolymer Metallic fluoropolymer FEVE fluoropolymer Siliconized polyester .
 - 3) Color: As indicated by manufacturer's designations Match Architect's samples As selected by Architect from manufacturer's full range.
 - iii Aluminum Sheet: Coil-coated sheet, ASTM B209 (ASTM B209M), alloy as standard with manufacturer, with temper as required to suit forming operations and structural performance required.
 - 1) Thickness: 0.032 inch (0.81 mm) 0.040 inch (1.02 mm).
 - 2) Surface: Smooth, flat Embossed finish.
 - 3) Exterior Finish: Two-coat fluoropolymer Three-coat fluoropolymer Mica fluoropolymer Metallic fluoropolymer FEVE fluoropolymer Siliconized polyester Clear anodized Color anodized .
 - 4) Color: As indicated by manufacturer's designations Match Architect's samples as selected by Architect from manufacturer's full range.
 - iv Clips: One-piece fixed to accommodate thermal movement.
 - 1) Material: 0.028-inch- (0.71-mm-) 0.064-inch- (1.63-mm-) nominal thickness, zinc-coated (galvanized) or aluminum-zinc alloy-coated steel sheet.
 - 2) Material: 0.0250-inch- (0.635-mm-) 0.0625-inch- (1.587-mm-) thick, stainless steel sheet.
 - v Joint Type: Single folded Double folded As standard with manufacturer.
 - vi Panel Coverage: 12 inches (305 mm) 14 inches (356 mm) 16 inches (406 mm) 18 inches (457 mm) 20 inches (508 mm) 24 inches (610 mm).
 - vii Panel Height: 1.5 inches (38 mm) 2.0 inches (51 mm) 2.5 inches (64 mm).

- d. Trapezoidal-Rib, Snap-Joint, Standing-Seam Metal Roof Panels: Formed with raised trapezoidal ribs at panel edges and intermediate stiffening ribs symmetrically spaced a flat pan between ribs; designed for sequential installation by mechanically attaching panels to supports using concealed clips located under one side of panels, engaging opposite edge of adjacent panels, and snapping panels together.
 - i Manufacturer: FABRAL, MS Metal Sales manufacturing
 - ii Metallic-Coated Steel Sheet: Zinc-coated (galvanized) steel sheet complying with ASTM A653/A653M, G90 (Z275) coating designation, or aluminum-zinc alloy-coated steel sheet complying with ASTM A792/A792M, Class AZ50 (Class AZM150) coating designation; structural quality. Pre-painted by the coil-coating process to comply with ASTM A755/A755M.
 - 1) Nominal Thickness: 0.022 inch (0.56 mm) 0.028 inch (0.71 mm) 0.034 inch (0.86 mm) 0.040 inch (1.02 mm) 0.052 inch (1.32 mm).
 - 2) Exterior Finish: Two-coat fluoropolymer Three-coat fluoropolymer Mica fluoropolymer Metallic fluoropolymer FEVE fluoropolymer Siliconized polyester .
 - 3) Color: As indicated by manufacturer's designations Match Architect's samples As selected by Architect from manufacturer's full range.
 - iii Panel Coverage: 12 inches (305 mm) 18 inches (457 mm) 24 inches (610 mm).
 - iv Panel Height: 3 inches (76 mm).
- e. Trapezoidal-Rib, Seamed-Joint, Standing-Seam Metal Roof Panels : Formed with raised trapezoidal ribs at panel edges and intermediate stiffening ribs symmetrically spaced a flat pan between ribs; designed for sequential installation by mechanically attaching panels to supports using concealed clips located under one side of panels, engaging opposite edge of adjacent panels, and mechanically seaming panels together.
 - i Manufacturer: FABRAL, MS Metal Sales manufacturing
 - ii Metallic-Coated Steel Sheet: Zinc-coated (galvanized) steel sheet complying with ASTM A653/A653M, G90 (Z275) coating designation, or aluminum-zinc alloy-coated steel sheet complying with ASTM A792/A792M, Class AZ50 (Class AZM150) coating designation; structural quality. Pre-painted by the coil-coating process to comply with ASTM A755/A755M.
 - 1) Nominal Thickness: 0.022 inch (0.56 mm) 0.028 inch (0.71 mm) 0.034 inch (0.86 mm) 0.040 inch (1.02 mm) 0.052 inch (1.32 mm).
 - 2) Exterior Finish: Two-coat fluoropolymer Three-coat fluoropolymer Mica fluoropolymer Metallic fluoropolymer
 - 3) Color: As indicated by manufacturer's designations Match Architect's samples As selected by Architect from manufacturer's full range.

3. UNDERLAYMENT MATERIALS

- a. Self-Adhering, High-Temperature Underlayment: Provide self-adhering, cold-applied, sheet underlayment, a minimum of 30 mils (0.76 mm) thick, consisting of slip-resistant, polyethylene-film top surface laminated to a layer of butyl or SBS-modified asphalt adhesive, with release-paper backing. Provide primer when recommended by underlayment manufacturer.
 - i Thermal Stability: Stable after testing at 240 deg F (116 deg C); ASTM D1970.
 - ii Low-Temperature Flexibility: Passes after testing at minus 20 deg F (29 deg C); ASTM D1970.
 - iii Per manufacturer recommendation.

4. MISCELLANEOUS MATERIALS

- a. Miscellaneous Metal Subframing and Furring: ASTM C645; cold-formed, metallic-coated steel sheet, ASTM A653/A653M, G90 (Z275 hot-dip galvanized) coating designation or ASTM A792/A792M, Class AZ50 (Class AZM150) coating designation unless otherwise indicated. Provide manufacturer's standard sections as required for support and alignment of metal panel system.
- b. Panel Accessories: Provide components required for a complete, weathertight panel system including trim, copings, fasciae, mullions, sills, corner units, clips, flashings, sealants, gaskets, fillers, closure strips, and similar items. Match material and finish of metal panels unless otherwise indicated.
 - i Closures: Provide closures at eaves and ridges, fabricated of same metal as metal panels.
 - ii Backing Plates: Provide metal backing plates at panel end splices, fabricated from material recommended by manufacturer.
 - iii Closure Strips: Closed-cell, expanded, cellular, rubber or crosslinked, polyolefin-foam or closed-cell laminated polyethylene; minimum 1-inch- (25-mm-) thick, flexible closure strips; cut or premolded to match metal panel profile. Provide closure strips where indicated or necessary to ensure weathertight construction.
- c. Flashing and Trim: Provide flashing and trim formed from same material as metal panels as required to seal against weather and to provide finished appearance. Locations include, but are not limited to, eaves, rakes, corners, bases, framed openings, ridges, fasciae, and fillers. Finish flashing and trim with same finish system as adjacent metal panels.
- d. Gutters: Formed from same material as roof panels, complete with end pieces, outlet tubes, and other special pieces as required. Fabricate in minimum 96-inch- (2400-mm-) long sections, of size and metal thickness according to SMACNA's "Architectural Sheet Metal Manual." Furnish gutter supports spaced a maximum of 36 inches (914 mm) o.c., fabricated from same metal as gutters. Provide wire ball strainers of compatible metal at outlets. Finish gutters to match metal roof panels roof fascia and rake trim.
- e. Downspouts: Formed from same material as roof panels. Fabricate in 10-foot- (3-m-) long sections, complete with formed elbows and offsets, of size and metal thickness according to SMACNA's "Architectural Sheet Metal Manual." Finish downspouts to match gutters.
- f. Roof Curbs: Fabricated from same material as roof panels, 0.048-inch (1.2-mm) nominal thickness; with bottom of skirt profiled to match roof panel profiles and with welded top box and integral full-length cricket. Fabricate curb subframing of 0.060-inch- (1.52-mm-) nominal thickness, angle-, C-, or Z-shaped steel sheet. Fabricate curb and subframing to withstand indicated loads of size and height indicated. Finish roof curbs to match metal roof panels.
 - i Insulate roof curb with 1-inch- (25-mm-) thick, rigid insulation.
- g. Panel Fasteners: Self-tapping screws designed to withstand design loads.
- h. Panel Sealants: Provide sealant type recommended by manufacturer that are compatible with panel materials, are nonstaining, and do not damage panel finish.
 - i Sealant Tape: Pressure-sensitive, 100 percent solids, gray polyisobutylene compound sealant tape with release-paper backing. Provide permanently elastic, nonsag, nontoxic, nonstaining tape 1/2 inch (13 mm) wide and 1/8 inch (3 mm) thick.
 - ii Joint Sealant: ASTM C920; elastomeric polyurethane or silicone sealant; of type, grade, class, and use classifications required to seal joints in metal panels and remain weathertight; and as recommended in writing by metal panel manufacturer.
 - iii Butyl-Rubber-Based, Solvent-Release Sealant: ASTM C1311.

5. FABRICATION

- a. Fabricate and finish metal panels and accessories at the factory, by manufacturer's standard procedures and processes, as necessary to fulfill indicated performance requirements demonstrated by laboratory testing. Comply with indicated profiles and with dimensional and structural requirements.
- b. On-Site Fabrication: Subject to compliance with requirements of this Section, metal panels may be fabricated on-site using UL-certified, portable roll-forming equipment if panels are of same profile and warranted by manufacturer to be equal to factory-formed panels. Fabricate according to equipment manufacturer's written instructions and to comply with details shown.
- c. Provide panel profile, including major ribs and intermediate stiffening ribs, if any, for full length of panel.
- d. Fabricate metal panel joints with factory-installed captive gaskets or separator strips that provide a weathertight seal and prevent metal-to-metal contact, and that minimize noise from movements.
- e. Sheet Metal Flashing and Trim: Fabricate flashing and trim to comply with manufacturer's recommendations and recommendations in SMACNA's "Architectural Sheet Metal Manual" that apply to design, dimensions, metal, and other characteristics of item indicated.
 - i Form exposed sheet metal accessories that are without excessive oil canning, buckling, and tool marks and that are true to line and levels indicated, with exposed edges folded back to form hems.
 - ii Seams for Aluminum: Fabricate nonmoving seams with flat-lock seams. Form seams and seal with epoxy seam sealer. Rivet joints for additional strength.
 - iii Seams for Other Than Aluminum: Fabricate nonmoving seams in accessories with flat-lock seams. Tin edges to be seamed, form seams, and solder.
 - iv Sealed Joints: Form nonexpansion, but movable, joints in metal to accommodate sealant and to comply with SMACNA standards.
 - v Conceal fasteners and expansion provisions where possible. Exposed fasteners are not allowed on faces of accessories exposed to view.
 - vi Fabricate cleats and attachment devices from same material as accessory being anchored or from compatible, noncorrosive metal recommended in writing by metal panel manufacturer.
 - 1) Size: As recommended by SMACNA's "Architectural Sheet Metal Manual" or metal panel manufacturer for application, but not less than thickness of metal being secured.

6. FINISHES

- a. Protect mechanical and painted finishes on exposed surfaces from damage by applying a strippable, temporary protective covering before shipping.
- b. Appearance of Finished Work: Variations in appearance of abutting or adjacent pieces are acceptable if they are within one-half of the range of approved Samples. Noticeable variations in same piece are unacceptable. Variations in appearance of other components are acceptable if they are within the range of approved Samples and are assembled or installed to minimize contrast.
- c. Steel Panels and Accessories:
 - i Two-Coat Fluoropolymer: AAMA 621. Fluoropolymer finish containing not less than 70 percent polyvinylidene fluoride (PVDF) resin by weight in color coat. Prepare, pretreat, and apply coating to exposed metal surfaces to comply with coating and resin manufacturers' written instructions for seacoast and severe environments.

- ii Three-Coat Fluoropolymer: AAMA 621. Fluoropolymer finish containing not less than 70 percent polyvinylidene fluoride (PVDF) resin by weight in both color coat and clear topcoat. Prepare, pretreat, and apply coating to exposed metal surfaces to comply with coating and resin manufacturers' written instructions for seacoast and severe environments.
 - iii Mica Fluoropolymer: AAMA 621. Two-coat fluoropolymer finish with suspended mica flakes containing not less than 70 percent polyvinylidene fluoride (PVDF) resin by weight in color coat. Prepare, pretreat, and apply coating to exposed metal surfaces to comply with coating and resin manufacturers' written instructions for seacoast and severe environments.
 - iv Metallic Fluoropolymer: AAMA 621. Three-coat fluoropolymer finish with suspended metallic flakes containing not less than 70 percent polyvinylidene fluoride (PVDF) resin by weight in both color coat and clear topcoat. Prepare, pretreat, and apply coating to exposed metal surfaces to comply with coating and resin manufacturers' written instructions for seacoast and severe environments.
 - v FEVE Fluoropolymer: AAMA 621. Two-coat fluoropolymer finish containing 100 percent fluorinated ethylene vinyl ether (FEVE) resin in color coat. Prepare, pretreat, and apply coating to exposed metal surfaces to comply with coating and resin manufacturers' written instructions.
 - vi Siliconized Polyester: Epoxy primer and silicone-modified, polyester-enamel topcoat; with a dry film thickness of not less than 0.2 mil (0.005 mm) for primer and 0.8 mil (0.02 mm) for topcoat.
 - vii Concealed Finish: Apply pretreatment and manufacturer's standard white or light-colored acrylic or polyester backer finish consisting of prime coat and wash coat with a minimum total dry film thickness of 0.5 mil (0.013 mm).
- d. Aluminum Panels and Accessories:
- i Two-Coat Fluoropolymer: AAMA 2605. Fluoropolymer finish containing not less than 70 percent polyvinylidene fluoride (PVDF) resin by weight in color coat. Prepare, pretreat, and apply coating to exposed metal surfaces to comply with coating and resin manufacturers' written instructions for seacoast and severe environments.
 - ii Three-Coat Fluoropolymer: AAMA 2605. Fluoropolymer finish containing not less than 70 percent polyvinylidene fluoride (PVDF) resin by weight in both color coat and clear topcoat. Prepare, pretreat, and apply coating to exposed metal surfaces to comply with coating and resin manufacturers' written instructions for seacoast and severe environments.
 - iii Mica Fluoropolymer: AAMA 2605. Two-coat fluoropolymer finish with suspended mica flakes containing not less than 70 percent polyvinylidene fluoride (PVDF) resin by weight in color coat. Prepare, pretreat, and apply coating to exposed metal surfaces to comply with coating and resin manufacturers' written instructions for seacoast and severe environments.
 - iv Metallic Fluoropolymer: AAMA 2605. Three-coat fluoropolymer finish with suspended metallic flakes containing not less than 70 percent polyvinylidene fluoride (PVDF) resin by weight in both color coat and clear topcoat. Prepare, pretreat, and apply coating to exposed metal surfaces to comply with coating and resin manufacturers' written instructions for seacoast and severe environments.
 - v FEVE Fluoropolymer: AAMA 2605. Two-coat fluoropolymer finish containing 100 percent fluorinated ethylene vinyl ether (FEVE) resin in color coat. Prepare, pretreat, and apply coating to exposed metal surfaces to comply with coating and resin manufacturers' written instructions.
 - vi Siliconized Polyester: Epoxy primer and silicone-modified, polyester-enamel topcoat; with a dry film thickness of not less than 0.2 mil (0.005 mm) for primer and 0.8 mil (0.02 mm) for topcoat.

- vii Exposed Anodized Finish:
 - 1) Clear Anodic Finish: AAMA 611, AA-M12C22A41, Class I, 0.018 mm AA-M12C22A31, Class II, 0.010 mm or thicker.
 - 2) Color Anodic Finish: AAMA 611, AA-M12C22A42/A44, Class I, 0.018 mm AA-M12C22A32/A34, Class II, 0.010 mm or thicker.

B.2 Metal Soffit Panels

- a. Structural Performance: Provide metal panel systems capable of withstanding the effects of the following loads, based on testing according to ASTM E1592:
 - i Wind Loads: As indicated on Drawings.
 - ii Other Design Loads: As indicated on Drawings
 - iii Deflection Limits: For wind loads, no greater than 1/180 Revised rate of air leakage in "Air Infiltration" Paragraph below to suit Project.
- b. Air Infiltration: Air leakage of not more than 0.06 cfm/sq. ft. (0.3 L/s per sq. m) when tested according to ASTM E283 at the following test-pressure difference:
 - i Test-Pressure Difference: 1.57 lbf/sq. ft. (75 Pa) 6.24 lbf/sq. ft. (300 Pa).
- c. Water Penetration under Static Pressure: No water penetration when tested according to ASTM E331 at the following test-pressure difference:
 - i Test-Pressure Difference: 2.86 lbf/sq. ft. (137 Pa) 6.24 lbf/sq. ft. (300 Pa).
- d. Thermal Movements: Allow for thermal movements from ambient and surface temperature changes by preventing buckling, opening of joints, overstressing of components, failure of joint sealants, failure of connections, and other detrimental effects. Base calculations on surface temperatures of materials due to both solar heat gain and nighttime-sky heat loss.
 - i Temperature Change (Range): 120 deg F (67 deg C), ambient; 180 deg F (100 deg C), material surfaces .

2. METAL SOFFIT PANELS

- a. Provide metal soffit panels designed to be installed by lapping and interconnecting side edges of adjacent panels and mechanically attaching through panel to supports using concealed fasteners in side laps. Include accessories required for weathertight installation.
- b. Flush-Profile Metal Soffit Panels: Solid Perforated panels formed with vertical panel edges and intermediate stiffening ribs symmetrically spaced a flat pan between panel edges; with flush joint between panels.
 - i Centria or approved equal.
 - ii Aluminum Sheet: Coil-coated sheet, ASTM B209 (ASTM B209M), alloy as standard with manufacturer, with temper as required to suit forming operations and structural performance required.
 - 1) Thickness: 0.032 inch (0.81 mm) 0.040 inch (1.02 mm).
 - 2) Surface: Smooth, flat Embossed finish.
 - 3) Exterior Finish: Two-coat fluoropolymer
 - 4) Metallic fluoropolymer FEVE fluoropolymer
 - 5) Color: As indicated by manufacturer's designations selected by Architect from manufacturer's full range.
 - iii Panel Coverage: 8 inches (203 mm) 12 inches (305 mm) 16 inches (406 mm) 20 inches (508 mm).
 - iv Panel Height: 0.875 inch (22 mm) 1.0 inch (25 mm) 1.5 inches (38 mm) 3.0 inches (76 mm).

3. MISCELLANEOUS MATERIALS

- a. Miscellaneous Metal Subframing and Furring: ASTM C645, cold-formed, metallic-coated steel sheet, ASTM A653/A653M, G90 (Z275 hot-dip galvanized) coating designation or ASTM A792/A792M, Class AZ50 (Class AZM150) aluminum-zinc-alloy coating designation unless otherwise indicated. Provide manufacturer's standard sections as required for support and alignment of metal panel system.
- b. Panel Accessories: Provide components required for a complete, weathertight panel system including trim, clips, flashings, sealants, gaskets, fillers, closure strips, and similar items. Match material and finish of metal panels unless otherwise indicated.
 - i Closure Strips: Closed-cell, expanded, cellular, rubber or crosslinked, polyolefin-foam or closed-cell laminated polyethylene; minimum 1-inch- (25-mm-) thick, flexible closure strips; cut or premolded to match metal panel profile. Provide closure strips where indicated or necessary to ensure weathertight construction.
- c. Flashing and Trim: Provide flashing and trim formed from same material as metal panels as required to seal against weather and to provide finished appearance. Finish flashing and trim with same finish system as adjacent metal panels.
- d. Panel Fasteners: Self-tapping screws designed to withstand design loads. Provide exposed fasteners with heads matching color of metal panels by means of plastic caps or factory-applied coating. Provide EPDM or PVC sealing washers for exposed fasteners.
- e. Panel Sealants: Provide sealant types recommended by manufacturer that are compatible with panel materials, are nonstaining, and do not damage panel finish.
 - i Sealant Tape: Pressure-sensitive, 100 percent solids, gray polyisobutylene compound sealant tape with release-paper backing. Provide permanently elastic, nonsag, nontoxic, nonstaining tape 1/2 inch (13 mm) wide and 1/8 inch (3 mm) thick.
 - ii Joint Sealant: ASTM C920; elastomeric polyurethane or silicone sealant; of type, grade, class, and use classifications required to seal joints in metal panels and remain weathertight; and as recommended in writing by metal panel manufacturer.
 - iii Butyl-Rubber-Based, Solvent-Release Sealant: ASTM C1311.

4. FABRICATION

- a. Fabricate and finish metal panels and accessories at the factory, by manufacturer's standard procedures and processes, as necessary to fulfill indicated performance requirements demonstrated by laboratory testing. Comply with indicated profiles and with dimensional and structural requirements.
- b. On-Site Fabrication: Subject to compliance with requirements of this Section, metal panels may be fabricated on-site using UL-certified, portable roll-forming equipment if panels are of same profile and warranted by manufacturer to be equal to factory-formed panels. Fabricate according to equipment manufacturer's written instructions and to comply with details shown.
- c. Provide panel profile, including major ribs and intermediate stiffening ribs, if any, for full length of panel.
- d. Fabricate metal panel joints with factory-installed captive gaskets or separator strips that provide a weathertight seal and prevent metal-to-metal contact, and that minimize noise from movements.
- e. Sheet Metal Flashing and Trim: Fabricate flashing and trim to comply with manufacturer's recommendations and recommendations in SMACNA's "Architectural Sheet Metal Manual" that apply to design, dimensions, metal, and other characteristics of item indicated.
 - i Form exposed sheet metal accessories that are without excessive oil canning, buckling, and tool marks and that are true to line and levels indicated, with exposed edges folded back to form hems.
 - ii Seams for Aluminum: Fabricate nonmoving seams with flat-lock seams. Form seams and seal with epoxy seam sealer. Rivet joints for additional strength.

- iii Seams for Other Than Aluminum: Fabricate nonmoving seams in accessories with flat-lock seams. Tin edges to be seamed, form seams, and solder.
- iv Sealed Joints: Form nonexpansion, but movable, joints in metal to accommodate sealant and to comply with SMACNA standards.
- v Conceal fasteners and expansion provisions where possible. Exposed fasteners are not allowed on faces of accessories exposed to view.
- vi Fabricate cleats and attachment devices from same material as accessory being anchored or from compatible, noncorrosive metal recommended in writing by metal panel manufacturer.
- vii Size: As recommended by SMACNA's "Architectural Sheet Metal Manual" or metal soffit panel manufacturer for application but not less than thickness of metal being secured.

5. FINISHES

- a. Protect mechanical and painted finishes on exposed surfaces from damage by applying a strippable, temporary protective covering before shipping.
- b. Appearance of Finished Work: Variations in appearance of abutting or adjacent pieces are acceptable if they are within one-half of the range of approved Samples. Noticeable variations in same piece are not acceptable. Variations in appearance of other components are acceptable if they are within the range of approved Samples and are assembled or installed to minimize contrast.
- c. Aluminum Panels and Accessories:
 - i Two-Coat Fluoropolymer: AAMA 2605. Fluoropolymer finish containing not less than 70 percent polyvinylidene fluoride (PVDF) resin by weight in color coat. Prepare, pretreat, and apply coating to exposed metal surfaces to comply with coating and resin manufacturers' written instructions for seacoast and severe environments.
 - ii Three-Coat Fluoropolymer: AAMA 2605. Fluoropolymer finish containing not less than 70 percent polyvinylidene fluoride (PVDF) resin by weight in both color coat and clear topcoat. Prepare, pretreat, and apply coating to exposed metal surfaces to comply with coating and resin manufacturers' written instructions for seacoast and severe environments.
 - iii Mica Fluoropolymer: AAMA 2605. Two-coat fluoropolymer finish with suspended mica flakes containing not less than 70 percent polyvinylidene fluoride (PVDF) resin by weight in color coat. Prepare, pretreat, and apply coating to exposed metal surfaces to comply with coating and resin manufacturers' written instructions for seacoast and severe environments.
 - iv Metallic Fluoropolymer: AAMA 2605. Three-coat fluoropolymer finish with suspended metallic flakes containing not less than 70 percent polyvinylidene fluoride (PVDF) resin by weight in both color coat and clear topcoat. Prepare, pretreat, and apply coating to exposed metal surfaces to comply with coating and resin manufacturers' written instructions for seacoast and severe environments.
 - v FEVE Fluoropolymer: AAMA 2605. Two-coat fluoropolymer finish containing 100 percent fluorinated ethylene vinyl ether (FEVE) resin in color coat. Prepare, pretreat, and apply coating to exposed metal surfaces to comply with coating and resin manufacturers' written instructions.
 - vi Siliconized Polyester: Epoxy primer and silicone-modified, polyester-enamel topcoat; with a dry film thickness of not less than 0.2 mil (0.005 mm) for primer and 0.8 mil (0.02 mm) for topcoat.

- vii Exposed Anodized Finish:
 - 1) Clear Anodic Finish: AAMA 611, AA-M12C22A41, Class I, 0.018 mm AA-M12C22A31, Class II, 0.010 mm or thicker.
 - 2) Color Anodic Finish: AAMA 611, AA-M12C22A42/A44, Class I, 0.018 mm AA-M12C22A32/A34, Class II, 0.010 mm or thicker.

B.3 EPDM Roofing

1. PERFORMANCE REQUIREMENTS

- a. General Performance: Installed roofing system and base flashings to withstand specified uplift pressures, thermally induced movement, and exposure to weather without failure due to defective manufacture, fabrication, installation, or other defects in construction. Roofing and flashings to remain watertight.
 - i Accelerated Weathering: Roof membrane to withstand 2000 hours of exposure when tested according to ASTM G152, ASTM G154, or ASTM G155.
 - ii Impact Resistance: Roof membrane to resist impact damage when tested according to ASTM D3746, ASTM D4272, or the "Resistance to Foot Traffic Test" in FM Approvals 4470.
- b. Material Compatibility: Roofing materials to be compatible with one another and adjacent materials under conditions of service and application required, as demonstrated by roof membrane manufacturer based on testing and field experience.
- c. Wind Uplift Resistance: Design roofing system to resist the following wind uplift pressures when tested according to FM Approvals 4474, UL 580, or UL 1897:
 - i Zone 1 (Roof Area Field): <350t lbf/sq. ft. (kPa)>.
 - ii Zone 2 (Roof Area Perimeter): <350 lbf/sq. ft. (kPa)>.
 - 1) Location: From roof edge to inside roof edge.
 - iii Zone 3 (Roof Area Corners): <350 lbf/sq. ft. (kPa)>.
 - 1) Location: in each direction from building corner.
- d. FM Approvals' RoofNav Listing: Roof membrane, base flashings, and component materials comply with requirements in FM Approvals 4450 or FM Approvals 4470 as part of a roofing system, and are listed in FM Approvals' RoofNav for Class 1 or noncombustible construction, as applicable. Identify materials with FM Approvals Certification markings.
 - i Fire/Windstorm Classification: Class 1A-75 Retain one option in "Hail-Resistance Rating" Subparagraph below based on geographical location of Project or desired rating. Verify availability of roofing systems, including specified components, that comply with these ratings using FM Approvals' RoofNav.
 - ii Hail-Resistance Rating: FM Global Property Loss Prevention Data Sheet 1-34 MH SH VSH.
- e. SPRI's Directory of Roof Assemblies Listing: Roof membrane, base flashings, and component materials comply with requirements in FM Approvals 4450 or FM Approvals 4470 as part of a roofing system and are listed in SPRI's Directory of Roof Assemblies for roof assembly identical for that specified for this Project.
 - i Wind Uplift Load Capacity: 90 psf
 - ii Retain applicable "Solar Reflectance Index," "ENERGY STAR Listing," or "Energy Performance" Paragraph below if "cool-roof" performance is required. Verify that EPDM roof membrane specified complies before retaining.
- f. ENERGY STAR Listing: Roofing system to be listed on the DOE's ENERGY STAR "Roof Products Qualified Product List" for low steep-slope roof products.
- g. Energy Performance: Roofing system to have an initial solar reflectance of not less than 0.70 and an emissivity of not less than 0.75 when tested according to ANSI/CRRC S100.

- h. Exterior Fire-Test Exposure: ASTM E108 or UL 790, Class B: for application and roof slopes indicated; testing by a qualified testing agency. Identify products with appropriate markings of applicable testing agency.
 - i. Fire-Resistance Ratings: Comply with fire-resistance-rated assembly designs indicated. Identify products with appropriate markings of applicable testing agency.
2. ETHYLENE-PROPYLENE-DIENE-TERPOLYMER (EPDM) ROOFING
- a. EPDM Sheet: ASTM D4637/D4637M, Type II, scrim or fabric internally reinforced, self-adhering EPDM sheet with factory-applied seam tape.
 - i. Manufacturer Carlisle, Johns Manville or approved equal.
 - ii. Thickness: 90 mils (1.9 mm), nominal.
 - iii. Exposed Face Color: Black
 - iv. Source Limitations: Obtain components for roofing system from roof membrane manufacturer or manufacturers approved by roof membrane manufacturer.
 - b. Fabric-Backed EPDM Sheet: ASTM D4637/D4637M, Type III, nonreinforced, EPDM sheet, laminated to a nonwoven polyester fabric backing except at selvages with factory-applied seam tape.
 - i. Manufacturer Carlisle, Johns Manville or approved equal.
 - ii. Composite Thickness: 90 mils (2.3 mm).
 - iii. Exposed Face Color: Black
 - iv. Source Limitations: Obtain components for roofing system from roof membrane manufacturer or manufacturers approved by roof membrane manufacturer.
3. ACCESSORY ROOFING MATERIALS
- a. General: Accessory materials recommended by roofing system manufacturer for intended use and compatible with other roofing components.
 - i. Adhesive and Sealants: Comply with VOC limits of authorities having jurisdiction.
 - b. Sheet Flashing: 90-mil- (1.5-mm-) thick EPDM, partially cured or cured, according to application.
 - c. Protection Sheet: Epichlorohydrin or neoprene nonreinforced flexible sheet, 55 to 60 mils (1.4 to 1.5 mm) thick, recommended by EPDM manufacturer for resistance to hydrocarbons, non-aromatic solvents, grease, and oil.
 - d. Slip Sheet: ASTM D2178/D2178M, Type IV; glass fiber; asphalt-impregnated felt Manufacturer's standard, of thickness required for application.
 - e. Asphalt-Coated, Glass-Fiber-Mat, Venting Base Sheet: ASTM D4897/D4897M, Type II; nonperforated, asphalt-impregnated fiberglass reinforced, with mineral granular patterned surfacing on bottom surface.
 - f. Prefabricated Pipe Flashings: As recommended by roof membrane manufacturer.
 - g. Roof Vents: As recommended by roof membrane manufacturer.
 - i. Size: Not less than 4-inch (100-mm) diameter.
 - h. Bonding Adhesive: Manufacturer's standard, water based.
 - i. Modified Asphaltic Fabric-Backed Membrane Adhesive: Roofing system manufacturer's standard modified asphalt, asbestos-free, cold-applied adhesive formulated for compatibility and use with fabric-backed membrane roofing.
 - j. Water-Based, Fabric-Backed Membrane Adhesive: Roofing system manufacturer's standard water-based, cold-applied adhesive formulated for compatibility and use with fabric-backed membrane roofing.

- k. Low-Rise, Urethane, Fabric-Backed Membrane Adhesive: Roof system manufacturer's standard spray-applied, low-rise, two-component urethane adhesive formulated for compatibility and use with fabric-backed membrane roofing.
 - l. Seaming Material: Single-component, butyl splicing adhesive and splice cleaner Manufacturer's standard, synthetic-rubber polymer primer and 3-inch- (75-mm-) wide minimum, butyl splice tape with release film Factory-applied seam tape, width as recommended by manufacturer.
 - m. Lap Sealant: Manufacturer's standard, single-component sealant, colored to match membrane roofing.
 - n. Water Cutoff Mastic: Manufacturer's standard butyl mastic sealant.
 - o. Metal Termination Bars: Manufacturer's standard, predrilled stainless steel or aluminum bars, approximately 1 by 1/8 inch (25 by 3 mm) thick; with anchors.
 - p. Metal Battens: Manufacturer's standard, aluminum-zinc-alloy-coated or zinc-coated steel sheet, approximately 1 inch wide by 0.05 inch thick (25 mm wide by 1.3 mm thick), prepunched.
 - q. Ballast Retaining Bar: Perimeter securement system consisting of a slotted extruded-aluminum retention bar with an integrated compression fastening strip.
 - i Fasteners: 1-1/2-inch (38-mm) stainless steel fasteners with neoprene washers.
 - r. Fasteners: Factory-coated steel fasteners and metal or plastic plates complying with corrosion-resistance provisions in FM Approvals 4470, designed for fastening components to substrate, and acceptable to roofing system manufacturer.
 - s. Miscellaneous Accessories: Provide pourable sealers, preformed cone and vent sheet flashings, molded pipe boot flashings, preformed inside and outside corner sheet flashings, reinforced EPDM securement strips, T-joint covers, in-seam sealants, termination reglets, cover strips, and other accessories.
 - i Provide white flashing accessories for white EPDM membrane roofing.
 - t. Liquid Coating: Product specifically formulated for coating EPDM membrane roofing, as follows:
 - i Type: Acrylic emulsion complying with ASTM D6083 Chlorosulfonated polyethylene complying with ASTM D3468/D3468M.
 - ii Color: Gray As selected by Architect from manufacturer's full range.
4. SUBSTRATE BOARD
- a. Fiber-Reinforced Gypsum Roof Board: ASTM C1278/C1278M, cellulosic-fiber reinforced, water-resistant gypsum board.
 - i Thickness: 1/4 inch (6 mm) 3/8 inch (10 mm) 1/2 inch (13 mm) 5/8 inch (16 mm).
 - b. Perlite Board: ASTM C728, seal coated.
 - i Thickness: 3/4 inch (19 mm) 1 inch (25.4 mm).
 - c. Fasteners: Factory-coated steel fasteners and metal or plastic plates complying with corrosion-resistance provisions in FM Approvals 4470, designed for fastening substrate panel to roof deck.
5. VAPOR RETARDER
- a. Polyethylene Film: ASTM D4397, 10 mils (0.25 mm) thick, minimum, with maximum permeance rating of 0.13 perm (0.084 metric perm) 0.076 perm (0.050 metric perm).
 - i Tape: Pressure-sensitive tape of type recommended by vapor retarder manufacturer for sealing joints and penetrations in vapor retarder.
 - ii Adhesive: Manufacturer's standard lap adhesive, listed by FM Approvals for vapor retarder application.

- b. Laminated Sheet Vapor Retarder: Two-layer, fire-retardant polyethylene laminate, reinforced with cord grid.
 - i Permeance Rating: Not more than 0.062 perm (3.556 ng/Pa x s x sq. m) when tested according to ASTM E96/E96M.
 - ii Flame-Spread Index: Not more than 5 when tested according to ASTM E84.
 - iii Smoke-Developed Index: Not more than 35 when tested according to ASTM E84.
 - iv Tape: Pressure-sensitive tape of type recommended by vapor retarder manufacturer for sealing joints and penetrations in vapor retarder.
- c. Rubberized-Asphalt-Sheet Vapor Retarder, Self-Adhering: ASTM D1970/D1970M, polyethylene film laminated to layer of rubberized asphalt adhesive, minimum 40-mil (1.0-mm) total thickness; maximum permeance rating of 0.1 perm (6 ng/Pa x s x sq. m); cold applied, with slip-resisting surface and release paper backing. Provide primer when recommended by vapor retarder manufacturer.
- d. Glass-Fiber Felts: ASTM D2178/D2178M, Type IV, asphalt impregnated.

6. ROOF INSULATION

- a. General: Preformed roof insulation boards manufactured or approved by EPDM roof membrane manufacturer, approved for use in FM Approvals' RoofNav-listed roof assemblies, approved for use in SPRI's Directory of Roof Assemblies listed roof assemblies.
- b. Extruded-Polystyrene Board Insulation: ASTM C578, Type IV, 1.45-lb/cu. ft. (23-kg/cu. m) minimum density, 25 psi (173 kPa) minimum compressive strength Type V, 3.00-lb/cu. ft. (48-kg/cu. m) minimum density, 100 psi (690 kPa) minimum compressive strength square edged.
 - i Thermal Resistance: R-value of 5.0 per 1 inch (25.4 mm).
 - ii Size: 48 by 48 inches (1219 by 1219 mm) 48 by 96 inches (1219 by 2438 mm).
 - iii Thickness:
 - 1) Base Layer: 1-1/2 inches (38 mm).
 - 2) Upper Layer.
- c. Tapered Insulation: Provide factory-tapered insulation boards.
 - i Material: Match roof insulation.
 - ii Minimum Thickness: 1/4 inch (6.35 mm).
 - iii Slope:
 - 3) Roof Field: 1/4 inch per foot (1:48)
 - 4) Saddles and Crickets: 1/2 inch per foot (1:24)

7. INSULATION ACCESSORIES AND COVER BOARD

- a. General: Roof insulation accessories recommended by insulation manufacturer for intended use and compatibility with other roofing system components.
- b. Fasteners: Factory-coated steel fasteners and metal or plastic plates complying with corrosion-resistance provisions in FM Approvals 4470, designed for fastening roof insulation and cover boards to substrate, and acceptable to roofing system manufacturer.
- c. Insulation Adhesive: Insulation manufacturer's recommended adhesive formulated to attach roof insulation to substrate or to another insulation layer as follows:
 - i Modified asphaltic, asbestos-free, cold-applied adhesive.
 - ii Bead-applied, low-rise, one-component or multicomponent urethane adhesive.
 - iii Full-spread, spray-applied, low-rise, two-component urethane adhesive.

- d. Fiber-Reinforced Gypsum Roof Board: ASTM C1278/C1278M, cellulosic-fiber reinforced, water-resistant gypsum board.
 - i Thickness: 1/4 inch (6 mm) 3/8 inch (10 mm) 1/2 inch (13 mm) 5/8 inch (16 mm).
 - e. Fiber-Reinforced Cementitious Cover Board: ASTM C1325, fiber-mat-reinforced cementitious board.
 - i Thickness: 7/16 inch (11 mm) 1/2 inch (13 mm) 5/8 inch (16 mm).
 - f. Polyisocyanurate Insulation Cover Board: ASTM C1289 Type II, Class 4, Grade 1, 1/2 inch (13 mm) thick, with a minimum compressive strength of 80 psi (551 kPa).
 - g. Protection Mat: Woven or nonwoven polypropylene, polyolefin, or polyester fabric; water permeable and resistant to UV degradation; type and weight as recommended by roofing system manufacturer for application.
8. ASPHALT MATERIALS
9. BALLAST
- a. Aggregate Ballast: Smooth, washed, riverbed gravel or other acceptable smooth-faced stone Crushed gravel or crushed stone that withstands weather exposure without significant deterioration and does not contribute to membrane degradation, of the following size:
 - i Size: ASTM D448, Size 2, ranging in size from 1-1/2 to 2-1/2 inches (38 to 63 mm) Size 3, ranging in size from 1 to 2 inches (25 to 50 mm) Size 4, ranging from 3/4 to 1-1/2 inches (19 to 38 mm).
 - b. Rubber Roof Pavers: Interlocking, lightweight rubber units, 24 by 24 by 2-1/4 inches (600 by 600 by 57 mm), 6 lb/sq. ft. (30 kg/sq. m); with grooved back for four-way drainage, beveled and doweled; and as follows:
 - i Perimeter Securement Strip: Manufacturer's standard coated steel sheet channel aluminum sheet channel mill-finish aluminum sheet hold down coated aluminum sheet hold down, color as selected by Architect, and fasteners.
 - ii Color: Black

B.4 Sheet Metal Flashing and Trim

1. PERFORMANCE REQUIREMENTS
- a. Sheet metal flashing and trim assemblies, including cleats, anchors, and fasteners, are to withstand wind loads, structural movement, thermally induced movement, and exposure to weather without failure due to defective manufacture, fabrication, installation, or other defects in construction. Completed sheet metal flashing and trim are not to rattle, leak, or loosen, and are to remain watertight.
 - b. Sheet Metal Standard for Flashing and Trim: Comply with NRCA's "The NRCA Roofing Manual: Architectural Metal Flashing, Condensation and Air Leakage Control, and Reroofing" and SMACNA's "Architectural Sheet Metal Manual" requirements for dimensions and profiles shown unless more stringent requirements are indicated.
 - c. Sheet Metal Standard for Copper: Comply with CDA's "Copper in Architecture Handbook." Conform to dimensions and profiles shown unless more stringent requirements are indicated.
 - d. SPRI Wind Design Standard: Manufacture and install copings roof edge flashings tested according to ANSI/SPRI/FM 4435/ES-1 and capable of resisting the following design pressure:
 - i Design Pressure: As indicated on Drawings.
 - e. FM Approvals Listing: Manufacture and install copings roof edge flashings that are listed in FM Approvals' "RoofNav" and approved for windstorm classification, Class 1-60 Class 1-75 Class 1-90 Class 1-105 Class 1-120 . Identify materials with name of fabricator and design approved by FM Approvals.

- f. Thermal Movements: Allow for thermal movements from ambient and surface temperature changes to prevent buckling, opening of joints, overstressing of components, failure of joint sealants, failure of connections, and other detrimental effects. Base calculations on surface temperatures of materials due to both solar heat gain and nighttime-sky heat loss.
 - i Temperature Change: 120 deg F (67 deg C), ambient; 180 deg F (100 deg C), material surfaces.

2. SHEET METALS

- a. Protect mechanical and other finishes on exposed surfaces from damage by applying strippable, temporary protective film before shipping.
- b. Aluminum Sheet: ASTM B209 (ASTM B209M), alloy as standard with manufacturer for finish required, with temper as required to suit forming operations and performance required; with smooth, flat surface.
 - i Clear Anodic Finish, Coil Coated: AAMA 611, AA-M12C22A41, Class I, 0.018 mm or thicker.
 - ii Color Anodic Finish, Coil Coated: AAMA 611, AA-M12C22A42/A44, Class I, 0.018 mm or thicker.
 - 1) Color: As selected by Architect from full range of industry colors and color densities.
 - 2) Color Range: Noticeable variations in same piece are unacceptable. Variations in appearance of adjoining components are acceptable if they are within the range of approved Samples and are assembled or installed to minimize contrast.

3. UNDERLAYMENT MATERIALS

- a. Self-Adhering, High-Temperature Sheet Underlayment: Minimum 30 mils (0.76 mm) thick, consisting of a slip-resistant polyethylene- or polypropylene-film top surface laminated to a layer of butyl- or SBS-modified asphalt adhesive, with release-paper backing; specifically designed to withstand high metal temperatures beneath metal roofing. Provide primer according to underlayment manufacturer's written instructions.
 - i Manufacturer: MFM building products, Henry or approved equal.
 - ii Source Limitations: Obtain underlayment from single source from single manufacturer.
 - iii Low-Temperature Flexibility: ASTM D1970/D1970M; passes after testing at minus 20 deg F (29 deg C) or lower.
- b. Slip Sheet: Rosin-sized building paper, 3 lb/100 sq. ft. (0.16 kg/sq. m) minimum.

4. MISCELLANEOUS MATERIALS

- a. Provide materials and types of fasteners, solder, protective coatings, sealants, and other miscellaneous items as required for complete sheet metal flashing and trim installation and as recommended by manufacturer of primary sheet metal or manufactured item unless otherwise indicated.
- b. Fasteners: Wood screws, annular threaded nails, self-tapping screws, self-locking rivets and bolts, and other suitable fasteners designed to withstand design loads and recommended by manufacturer of primary sheet metal or manufactured item.
 - i General: Blind fasteners or self-drilling screws, gasketed, with hex-washer head.
 - 1) Exposed Fasteners: Heads matching color of sheet metal using plastic caps or factory-applied coating. Provide metal-backed EPDM or PVC sealing washers under heads of exposed fasteners bearing on weather side of metal.
 - 2) Blind Fasteners: High-strength aluminum or stainless steel rivets suitable for metal being fastened.
 - 3) Spikes and Ferrules: Same material as gutter; with spike with ferrule matching internal gutter width.

- ii Fasteners for Copper, Zinc-Tin Alloy-Coated Copper, or Copper-Clad Stainless Steel Sheet: Copper, hardware bronze or passivated Series 300 stainless steel.
 - iii Fasteners for Aluminum Sheet: Aluminum or Series 300 stainless steel.
 - iv Fasteners for Stainless Steel Sheet: Series 300 stainless steel.
 - v Fasteners for Zinc-Coated (Galvanized) or Aluminum-Zinc Alloy-Coated Steel Sheet: Series 300 stainless steel or hot-dip galvanized steel according to ASTM A153/A153M or ASTM F2329.
 - vi Fasteners for Zinc Sheet: Series 300 stainless steel or hot-dip galvanized steel according to ASTM A153/A153M or ASTM F2329.
- c. Sealant Tape: Pressure-sensitive, 100 percent solids, polyisobutylene compound sealant tape with release-paper backing. Provide permanently elastic, nonsag, nontoxic, nonstaining tape 1/2 inch (13 mm) wide and 1/8 inch (3 mm) thick.
- d. Elastomeric Sealant: ASTM C920, elastomeric polyurethane polysulfide silicone polymer sealant; of type, grade, class, and use classifications required to seal joints in sheet metal flashing and trim and remain watertight.
- e. Reglets: Units of type, material, and profile required, formed to provide secure interlocking of separate reglet and counterflashing pieces, and compatible with flashing indicated with factory-mitered and -welded corners and junctions and with interlocking counterflashing on exterior face, of same metal as reglet.
- i Architectural products co, KY or approved equal
 - ii Source Limitations: Obtain reglets from single source from single manufacturer.
 - iii Material: Stainless steel, 0.0188 inch (0.477 mm) thick Copper, 16 oz./sq. ft. (0.55 mm thick) Aluminum, 0.024 inch (0.61 mm) thick Galvanized steel, 0.022 inch (0.56 mm) thick.
 - iv Surface-Mounted Type: Provide with slotted holes for fastening to substrate, with neoprene or other suitable weatherproofing washers, and with channel for sealant at top edge.
 - v Stucco Type: Provide with upturned fastening flange and extension leg of length to match thickness of applied finish materials.
 - vi Concrete Type: Provide temporary closure tape to keep reglet free of concrete materials, special fasteners for attaching reglet to concrete forms, and guides to ensure alignment of reglet section ends.
 - vii Masonry Type: Provide with offset top flange for embedment in masonry mortar joint.
 - viii Accessories:
 - 1) Flexible-Flashing Retainer: Provide resilient plastic or rubber accessory to secure flexible flashing in reglet where clearance does not permit use of standard metal counterflashing or where Drawings show reglet without metal counterflashing.
 - 2) Counterflashing Wind-Restraint Clips: Provide clips to be installed before counterflashing to prevent wind uplift of counterflashing's lower edge.
 - ix Finish: Mill With manufacturer's standard color coating .

5. FABRICATION, GENERAL

- a. Custom fabricate sheet metal flashing and trim to comply with details indicated and recommendations in cited sheet metal standard that apply to design, dimensions, geometry, metal thickness, and other characteristics of item required.
 - i Fabricate sheet metal flashing and trim in shop to greatest extent possible.
 - ii Fabricate sheet metal flashing and trim in thickness or weight needed to comply with performance requirements, but not less than that specified for each application and metal.

- iii Verify shapes and dimensions of surfaces to be covered and obtain field measurements for accurate fit before shop fabrication.
 - iv Form sheet metal flashing and trim to fit substrates without excessive oil-canning, buckling, and tool marks; true to line, levels, and slopes; and with exposed edges folded back to form hems.
 - v Conceal fasteners and expansion provisions where possible. Do not use exposed fasteners on faces exposed to view.
- b. Fabrication Tolerances:
- i Fabricate sheet metal flashing and trim that is capable of installation to a tolerance of 1/4 inch in 20 feet (6 mm in 6 m) on slope and location lines indicated on Drawings and within 1/8-inch (3-mm) offset of adjoining faces and of alignment of matching profiles.
 - ii Fabricate sheet metal flashing and trim that is capable of installation to tolerances specified.
- c. Expansion Provisions: Form metal for thermal expansion of exposed flashing and trim.
- i Form expansion joints of intermeshing hooked flanges, not less than 1 inch (25 mm) deep, filled with butyl sealant concealed within joints.
 - ii Use lapped expansion joints only where indicated on Drawings.
- d. Sealant Joints: Where movable, nonexpansion-type joints are required, form metal according to cited sheet metal standard to provide for proper installation of elastomeric sealant.
- e. Fabricate cleats and attachment devices from same material as accessory being anchored or from compatible, noncorrosive metal.
- f. Fabricate cleats and attachment devices of sizes as recommended by cited sheet metal standard and by FM Global Property Loss Prevention Data Sheet 1-49 for application, but not less than thickness of metal being secured.
- g. Seams:
- i Fabricate nonmoving seams with flat-lock seams. Tin edges to be seamed, form seams, and solder.
 - ii Fabricate nonmoving seams with flat-lock seams. Form seams and seal with elastomeric sealant unless otherwise recommended by sealant manufacturer for intended use. Rivet joints where necessary for strength.

6. ROOF-DRAINAGE SHEET METAL FABRICATIONS

- a. Hanging Gutters:
- i Fabricate to cross section required, complete with end pieces, outlet tubes, and other accessories as required.
 - ii Fabricate in minimum 96-inch- (2400-mm-) long sections.
 - iii Furnish flat-stock gutter brackets and flat-stock twisted gutter spacers and straps fabricated from same metal as gutters, of size recommended by cited sheet metal standard, but with thickness not less than twice the gutter thickness dimension indicated on Drawings.
 - iv Fabricate expansion joints, expansion-joint covers, gutter bead reinforcing bars, and gutter accessories from same metal as gutters. Shop fabricate interior and exterior corners.
 - v Gutter Profile: Style A Style B Style C Style D Style E Style F Style G Style H Style I Style J Style K Style L according to cited sheet metal standard.
 - vi Expansion Joints: Lap type Butt type Butt type with cover plate built in.
 - vii Accessories: Continuous, removable leaf screen with sheet metal frame and hardware cloth screen Wire-ball downspout strainer Valley baffles.

- viii Gutters with Girth up to 15 Inches (380 mm): Fabricate from the following materials:
 - 1) Aluminum: 0.032 inch (0.81 mm) thick.
- ix Gutters with Girth 16 to 20 Inches (410 to 510 mm): Fabricate from the following materials:
 - 1) Aluminum: 0.040 inch (1.02 mm) thick.
- x Gutters with Girth 21 to 25 Inches (530 to 640 mm): Fabricate from the following materials:
 - 1) Aluminum: 0.050 inch (1.27 mm) thick.
- xi Gutters with Girth 26 to 30 Inches (660 to 760 mm): Fabricate from the following materials:
 - 1) Aluminum: 0.063 inch (1.60 mm) thick.
- xii Gutters with Girth 31 to 35 Inches (790 to 890 mm): Fabricate from the following materials:
 - 1) Aluminum: 0.063 inch (1.60 mm) thick.
- b. Built-in Gutters:
 - i Fabricate to cross section required, with riveted and soldered joints, complete with end pieces, outlet tubes, and other special accessories as required.
 - ii Fabricate in minimum 96-inch- (2400-mm-) long sections. Fabricate expansion joints and accessories from same metal as gutters unless otherwise indicated.
 - iii Fabricate gutters with built-in expansion joints and gutter-end expansion joints at walls.
 - iv Accessories: Continuous, removable leaf screen with sheet metal frame and hardware cloth screen Bronze wire-ball downspout strainer Wire-ball downspout strainer.
 - v Fabricate from the following materials:
 - 1) Zinc: 0.032 inch (0.80 mm) 0.039 inch (1.00 mm) thick.
- c. Downspouts: Fabricate rectangular open-face downspouts to dimensions indicated on Drawings, complete with mitered elbows. Furnish with metal hangers from same material as downspouts and anchors. Shop fabricate elbows.
 - i Fabricated Hanger Style: Fig. 1-35A Fig. 1-35B Fig. 1-35C Fig. 1-35D Fig. 1-35E Fig. 1-35F Fig. 1-35G Fig. 1-35H Fig. 1-35I Fig. 1-35J according to SMACNA's "Architectural Sheet Metal Manual."
 - ii Manufactured Hanger Style: Fig. 1-34A Fig. 1-34B Fig. 1-34C Fig. 1-34D Fig. 1-34E according to SMACNA's "Architectural Sheet Metal Manual."
 - iii Fabricate from the following materials:
 - 1) Aluminum: 0.024 inch (0.61 mm) thick.
- d. Parapet Scuppers: Fabricate scuppers to dimensions required, with closure flange trim to exterior, 4-inch- (100-mm-) wide wall flanges to interior, and base extending 4 inches (100 mm) beyond cant or tapered strip into field of roof. Fasten gravel guard angles to base of scupper. Fabricate from the following materials:
 - i Aluminum: 0.032 inch (0.81 mm) thick.
- e. Conductor Heads: Fabricate conductor heads with flanged back and stiffened top edge and of dimensions and shape required, complete with outlet tubes, exterior flange trim, and built-in overflows. Fabricate from the following materials:
 - i Aluminum: 0.032 inch (0.81 mm) thick.
- f. Splash Pans: Fabricate to dimensions and shape required and from the following materials:
 - i Aluminum: 0.040 inch (1.02 mm) thick.

7. SLOPE ROOF SHEET METAL FABRICATIONS

- a. Roof Edge Flashing (Gravel Stop) and Fascia Cap: Fabricate in minimum 96-inch- (2400-mm-) long, but not exceeding 12-foot- (3.6-m-) long sections. Furnish with 6-inch- (150-mm-) wide, joint cover plates. Shop fabricate interior and exterior corners.
 - i Joint Style: Overlapped, 4 inches (100 mm) wide Butted with expansion space and 6-inch- (150-mm-) wide, concealed backup plate Butted with expansion space and 6-inch- (150-mm-) wide, exposed cover plate.
 - ii Fabricate with scuppers spaced 10 feet (3 m) apart, to dimensions required with 4-inch- (100-mm-) wide flanges and base extending 4 inches (100 mm) beyond cant or tapered strip into field of roof. Fasten gravel guard angles to base of scupper.
 - iii Fabricate from the following materials:
 - 1) Aluminum: 0.050 inch (1.27 mm) thick.
- b. Copings: Fabricate in minimum 96-inch- (2400-mm-) long, but not exceeding 12-foot- (3.6-m-) long, sections. Fabricate joint plates of same thickness as copings. Furnish with continuous cleats to support edge of external leg and drill elongated holes for fasteners on interior leg. Miter corners, fasten and seal solder or weld watertight. Shop fabricate interior and exterior corners.
 - i Coping Profile: Fig. 3-4A Fig. 3-4B Fig. 3-4C Fig. 3-4D Fig. 3-4E Fig. 3-4F Fig. 3-4G according to SMACNA's "Architectural Sheet Metal Manual."
 - ii Joint Style: Butted with expansion space and 6-inch- (150-mm-) wide, concealed backup plate Butted with expansion space and 6-inch- (150-mm-) wide, exposed cover plate .
 - iii Fabricate from the following materials:
 - 1) Aluminum: 0.050 inch (1.27 mm) thick.
- c. Expansion-Joint Cover: Shop fabricate interior and exterior corners. Fabricate roof and roof-to-wall transition roof-to-roof edge-flashing (gravel-stop) transition roof-to-roof edge-flashing (gravel-stop) and fascia-cap transition expansion-joint cover from the following materials:
 - i Aluminum: 0.050 inch (1.27 mm) thick.
- d. Base Flashing: Shop fabricate interior and exterior corners. Fabricate from the following materials:
 - i Aluminum: 0.040 inch (1.02 mm) thick.
- e. Counterflashing: Shop fabricate interior and exterior corners. Fabricate from the following materials:
 - i Aluminum: 0.032 inch (0.81 mm) thick.
- f. Flashing Receivers: Fabricate from the following materials:
 - i Aluminum: 0.032 inch (0.81 mm) thick.
- g. Roof-Penetration Flashing: Fabricate from the following materials:
 - i Zinc: 0.032 inch (0.80 mm) 0.039 inch (1.00 mm) thick.
- h. Roof-Drain Flashing: Fabricate from the following materials:
 - i Copper: 12 oz./sq. ft. (0.41 mm thick).
 - ii Stainless Steel: 0.0156 inch (0.396 mm) thick.
 - iii Copper-Clad Stainless Steel: 0.016 inch (0.40 mm) thick.

8. WALL SHEET METAL FABRICATIONS

- a. Through-Wall Flashing: Fabricate continuous flashings in minimum 96-inch- (2400-mm-) long, but not exceeding 12-foot- (3.6-m-) long, sections, under copings, and at shelf angles. Fabricate discontinuous lintel, sill, and similar flashings to extend 6 inches (150 mm) beyond each side of wall openings; and form with 2-inch- (50-mm-) high, end dams. Fabricate from the following materials:
 - i Zinc-Tin Alloy-Coated Copper: 16 oz./sq. ft. (0.55 mm thick).
- b. Opening Flashings in Frame Construction: Fabricate head, sill, jamb, and similar flashings to extend 4 inches (100 mm) beyond wall openings. Form head and sill flashing with 2-inch- (50-mm-) high, end dams. Fabricate from the following materials:
 - i Aluminum: 0.032 inch (0.81 mm) thick.
- c. Wall Expansion-Joint Cover: Fabricate from the following materials:
 - i Aluminum: 0.040 inch (1.02 mm) thick.

9. MISCELLANEOUS SHEET METAL FABRICATIONS

- a. Equipment Support Flashing: Fabricate from the following materials:
 - i Galvanized Steel: 0.028 inch (0.71 mm) thick.
 - ii Copper-Clad Stainless Steel: 0.018 inch (0.46 mm) thick.
- b. Overhead-Piping Safety Pans: Fabricate from the following materials:
 - i Galvanized Steel: 0.040 inch (1.02 mm) thick.
 - ii Copper-Clad Stainless Steel: 0.027 inch (0.69 mm) thick.

B.5 Manufactured Roof Expansion Joints

1. PERFORMANCE REQUIREMENTS

- a. Thermal Movements: Allow for thermal movements from ambient and surface temperature changes to prevent buckling, opening of joints, hole elongation, overstressing of components, failure of joint seals, failure of connections, and other detrimental effects.
 - i Temperature Change: 120 deg F (67 deg C), ambient; 180 deg F (100 deg C), material surfaces.
- b. Fire-Resistance Rating: Comply with ASTM E1966 or UL 2079; testing by a qualified testing agency to resist the spread of fire and to accommodate building thermal and seismic movements without impairing its ability to resist the passage of fire and hot gases. Identify products with appropriate markings of applicable testing agency.
 - i Rating: Not less than 2-hour fire-resistance rating of the roof assembly.
 - ii Indicate design designations from UL's "Fire Resistance Directory" or from the listings of another qualified testing agency.

2. FLANGED BELLOWS-TYPE ROOF EXPANSION JOINTS

- a. Flanged Bellows-Type Roof Expansion Joint: Factory-fabricated, continuous, waterproof, joint cover consisting of exposed membrane bellows laminated to flexible, closed-cell support foam, and secured along each edge to 3- to 4-inch- (76- to 100-mm-) wide metal flange.
 - i Manufacturer: INPRO 615 series roof and wall exterior -2" wide
 - ii Source Limitations: Obtain flanged bellows-type roof expansion joints approved by roofing manufacturer and that are part of roofing membrane warranty.
 - iii Joint Movement Capability: Plus and minus 25 percent of joint size 50 percent of joint size As indicated on Drawings.
 - iv Bellows: EPDM Neoprene PVC flexible membrane, nominal 60 mils (1.5 mm) thick.

- v Flanges: Galvanized steel, 0.022 inch (0.56 mm) thick Copper, 16 oz./sq. ft. (0.55 mm) thick Stainless steel, 0.0188 inch (0.477 mm) thick Aluminum, 0.032 inch (0.81 mm) thick.
 - vi Configuration: Flat to fit cants Angle formed to fit curbs as indicated on Drawings.
 - vii Corner, Intersection, and Transition Units: Provide factory-fabricated units for corner and joint intersections and horizontal and vertical transitions including those to other building expansion joints.
 - viii Cover Membrane: EPDM Neoprene PVC flexible membrane, factory laminated to bellows and covering entire joint assembly and curbs.
 - 1) Color: Black
 - ix Accessories: Provide splicing units, adhesives, and other components as recommended by roof-expansion-joint manufacturer for complete installation.
 - x Secondary Seal: Continuous, waterproof membrane within joint and attached to substrate on sides of joint below the primary bellows assembly.
 - 1) Drain-Tube Assemblies: Equip secondary seal with drain tubes and seals to direct collected moisture to drain to exterior-wall expansion joint cover as indicated on Drawings.
 - 2) Thermal Insulation: Fill space above secondary seal with mineral-fiber blanket manufacturer's standard, factory-installed mineral-fiber insulation; with maximum flame-spread and smoke-developed indexes of 25 and 50, respectively, per ASTM E84.
 - xi Fire Barrier: Manufacturer's standard fire barrier for fire-resistance-rated expansion joint system.
- b. Materials:
- i Aluminum Sheet: ASTM B209 (ASTM B209M), mill finish, with temper to suit forming operations and performance required.
 - 1) Apply manufacturer's standard protective coating on aluminum surfaces to be placed in contact with cementitious or preservative-treated wood materials.
 - ii EPDM Membrane: ASTM D4637/D4637M, type standard with manufacturer for application.
 - iii Neoprene Membrane: Neoprene sheet recommended by EPDM manufacturer for resistance to hydrocarbons, non-aromatic solvents, grease, and oil; and as standard with roof-expansion-joint manufacturer for application.
 - iv PVC Membrane: ASTM D4434/D4434M, type standard with manufacturer for application.

3. EXTRUDED BELLOWS ROOF EXPANSION JOINTS

- a. Extruded Bellows Roof Expansion Joint: Manufactured, continuous, waterproof, joint cover assembly; consisting of primary and secondary, single-layered, elastomeric seals; secured along each edge with extruded-aluminum retainers for fastening to substrate.
 - i Manufacturer: INPRO 615 series 2" gap for walls and ceilings; Series 221 for slab
 - ii Joint Movement Capability: Plus and minus 25 percent of joint size 50 percent of joint size As indicated on Drawings.
 - iii Primary Seal: Silicone extrusion; color: Black White Bronze Sandstone Gray As selected by Architect from manufacturer's full range.
 - iv Secondary Seal: EPDM, or manufacturer's standard elastomeric seal.
 - v Drain-Tube Assemblies: Equip secondary seal with drain tubes and seals to direct collected moisture to drain to exterior-wall expansion joint cover as indicated on Drawings.

- vi Corner, Intersection, and Transition Units: Provide factory-fabricated units for corner and joint intersections and horizontal and vertical transitions including those to other building expansion joints.
- b. Materials:
- i Aluminum: ASTM B221 (ASTM B221M) for extrusions; mill finish, with temper to suit forming operations and performance required.
 - 1) Apply manufacturer's standard protective coating on aluminum surfaces in contact with cementitious or preservative-treated wood materials.
 - ii Silicone Extrusions: ASTM D2000, UV stabilized, and that does not propagate flame.
 - iii EPDM Membrane: ASTM D4637, type standard with manufacturer for application.
4. PREFORMED FOAM SEALANT-TYPE ROOF EXPANSION JOINT
- a. Preformed Sealant-Type Roof Expansion Joint: Factory-fabricated, continuous, waterproof, UV stable expansion joint consisting of exposed silicone cap laminated to each side of fire-retardant-impregnated polyurethane foam sealant.
- i INPRO 1200 series for walls, 1100 series for floor
 - ii Source Limitations: Obtain preformed sealant-type roof expansion joints approved by roofing manufacturer and that are part of roofing membrane warranty.
 - iii Joint Movement Capability: Plus and minus 25 percent of joint size 50 percent of joint size As indicated on Drawings.
 - iv Corner, Intersection, and Transition Units: Provide factory-fabricated units for corner and joint intersections and horizontal and vertical transitions, including those to other building expansion joints.
 - v Facing: Uncoated Coated on both sides.
 - 1) Color: black.
 - vi Accessories: Provide adhesives and other components as recommended by roof-expansion-joint manufacturer for complete installation.
 - vii Edge and Splice Sealant: Manufacturer's standard silicone sealant for finishing edges and splice seams.
- b. Materials:
- i Foam: Polyurethane foam impregnated with fire-retardant acrylic polymers.
 - ii Silicone Facings: ASTM C920, ultra-low-modulus, one-part, neutral-cure silicone sealant, UV stabilized, and that does not propagate flame.
5. MISCELLANEOUS MATERIALS
- a. Adhesives: As recommended by roof-expansion-joint manufacturer.
 - b. Fasteners: Manufacturer's recommended fasteners, suitable for application and designed to withstand design loads.
 - i Exposed Fasteners: Gasketed. Use screws with hex washer heads matching color of material being fastened.
 - c. Mineral-Fiber Blanket: ASTM C665.
 - d. Bituminous Coating: Cold-applied asphalt emulsion complying with ASTM D1187.

B.6 Roof Accessories

1. PERFORMANCE REQUIREMENTS

- a. General Performance: Roof accessories to withstand exposure to weather and resist thermally induced movement without failure, rattling, leaking, or fastener disengagement due to defective manufacture, fabrication, installation, or other defects in construction.

- b. Delegated Design: Engage a qualified professional engineer, to design roof curbs and equipment supports to comply with wind performance requirements, including comprehensive engineering analysis by a qualified professional engineer, using performance requirements and design criteria indicated.
- c. Wind-Restraint Performance: As indicated on Drawings.

2. ROOF CURBS

- a. Roof Curbs: Internally reinforced roof-curb units capable of supporting superimposed live and dead loads, including equipment loads and other construction indicated on Drawings, bearing continuously on roof structure, and capable of meeting performance requirements; with welded or mechanically fastened and sealed corner joints, straight sides, integral metal cant, stepped integral metal cant raised the thickness of roof insulation, and integrally formed deck-mounting flange at perimeter bottom.
- b. Size: Coordinate dimensions with roughing-in information or Shop Drawings of equipment to be supported.
- c. Supported Load Capacity: Coordinate load capacity with information on Shop Drawings of equipment to be supported.
- d. Aluminum: 0.125 inch (3.17 mm) thick sheet.
 - i Finish: Clear anodic
 - ii Color: As selected by Architect from manufacturer's full range.
- e. Construction:
 - i Curb Profile: Manufacturer's standard Profile as indicated on Drawings compatible with roofing system.
 - ii On ribbed or fluted metal roofs, form deck-mounting flange at perimeter bottom to conform to roof profile.
 - iii Fabricate curbs to minimum height of 12 inches (305 mm) above roofing surface unless otherwise indicated.
 - iv Top Surface: Level top of curb, with roof slope accommodated by sloping deck-mounting flange or by use of leveler frame.
 - v Sloping Roofs: Where roof slope exceeds 1:48, fabricate curb with perimeter curb height tapered to accommodate roof slope so that top surface of perimeter curb is level. Equip unit with water diverter or cricket on side that obstructs water flow.
 - vi Insulation: Factory insulated with 1-1/2-inch- (38-mm-) thick glass-fiber board insulation.
 - vii Liner: Same material as curb, of manufacturer's standard thickness and finish.
 - viii Nailer: Factory-installed wood nailer along top flange of curb under top flange on side of curb, continuous around curb perimeter.
 - ix Wind Restraint Straps and Base Flange Attachment: Provide wind restraint straps, welded strap connectors, and base flange attachment to roof structure at perimeter of curb, of size and spacing required to meet wind uplift requirements.
 - x Platform Cap: Where portion of roof curb is not covered by equipment, provide weathertight platform cap formed from 3/4-inch- (19-mm-) thick plywood covered with metal sheet of same type, thickness, and finish as required for curb.
 - xi Metal Counterflashing: Manufacturer's standard, removable, fabricated of same metal and finish as curb.
 - xii Damper Tray: Provide damper tray or shelf with opening 3 inches (76 mm less than interior curb dimensions indicated of size indicated).

3. PIPE AND DUCT SUPPORTS

- a. Fixed-Height Cradle-Type Pipe Supports: Polycarbonate pipe stand accommodating up to 1-1/2-inch- (38-mm-) diameter pipe or conduit; with provision for pipe retainer and with manufacturer's support pad or deck plate as recommended for penetration-free installation over roof membrane type, as required for quantity of pipe runs and sizes.
- b. Fixed-Height Roller-Bearing Pipe Supports: Polycarbonate pipe stand with polycarbonate stainless steel roller carrying assembly accommodating up to 7-inch- (178-mm-) diameter pipe or conduit; with provision for pipe retainer and with manufacturer's support pad or deck plate as recommended for penetration-free installation over roof membrane type, as required for quantity of pipe runs and sizes.
- c. Adjustable-Height Roller-Bearing Pipe Supports: Polycarbonate pipe stand base, pipe support, and roller housing, with stainless steel threaded rod designed for adjusting support height, accommodating up to 18 inch (457 mm) diameter pipe or conduit; with provision for pipe retainer and with manufacturer's support pad or deck plate as recommended for penetration-free installation over roof membrane type; as required for quantity of pipe runs and sizes.
- d. Adjustable-Height Structure-Mounted Pipe Supports: Extruded-aluminum tube, filled with urethane insulation; 2 inches (50 mm) in diameter; accommodating up to 8-inch- diameter pipe or conduit, with provision for pipe retainer; with aluminum baseplate, EPDM base seal, manufacturer's recommended hardware for mounting to structure or structural roof deck as indicated, stainless steel roller and retainer, and extruded-aluminum carrier assemblies, as required for quantity of pipe runs and sizes.
- e. Curb-Mounted Pipe Supports: Galvanized steel support with welded or mechanically fastened and sealed corner joints, straight sides, integral metal cant, stepped integral metal cant raised the thickness of roof insulation, and integrally formed deck-mounting flange at perimeter bottom; with adjustable-height roller-bearing pipe support accommodating up to 20-inch- (508-mm-) diameter pipe or conduit and with provision for pipe retainer; as required for quantity of pipe runs and sizes.
- f. Duct Supports: Extruded-aluminum, urethane-insulated supports, 2 inches (50 mm) in diameter; with manufacturer's recommended hardware for mounting to structure or structural roof deck.
 - i Finish: Manufacturer's standard.

4. PIPE PORTALS

- a. Curb-Mounted Pipe Portal: Insulated roof-curb units with welded or mechanically fastened and sealed corner joints, straight sides, integral metal cant, stepped integral metal cant raised the thickness of roof insulation, and integrally formed deck-mounting flange at perimeter bottom; with weathertight curb cover with single or multiple collared openings and pressure-sealed conically shaped EPDM protective rubber caps sized for piping indicated, with stainless steel snaplock swivel clamps.
- b. Flashing Pipe Portal: Formed aluminum membrane-mounting flashing flange and sleeve with collared opening and pressure-sealed conically shaped EPDM protective rubber cap sized for piping indicated, with stainless steel snaplock swivel clamps.

5. PREFORMED FLASHING SLEEVES

- a. Exhaust Vent Flashing: Double-walled metal flashing sleeve or boot, insulation filled, with integral deck flange, 12 inches (300 mm) high, with removable metal hood and slotted perforated metal collar.
 - i Metal: Aluminum sheet, 0.063 inch (1.60 mm) thick.
 - ii Diameter: As indicated on Drawings
 - iii Finish: Manufacturer's standard

- b. Vent Stack Flashing: Metal flashing sleeve, uninsulated, with integral deck flange.
 - i Metal: Aluminum sheet, 0.063 inch (1.60 mm) thick
 - ii Height: 13 inches (330 mm)
 - iii Diameter: As indicated on Drawings
 - iv Finish: Manufacturer's standard

6. METAL MATERIALS

- a. Aluminum Sheet: ASTM B209 (ASTM B209M), manufacturer's standard alloy for finish required, with temper to suit forming operations and performance required.
 - i Mill Finish: As manufactured.
 - ii Factory Prime Coating: Where field painting is indicated, apply pretreatment and white or light-colored, factory-applied, baked-on epoxy primer coat, with a minimum dry film thickness of 0.2 mil (0.005 mm).
 - iii Clear Anodic Finish: AAMA 611, AA-M12C22A41, Class I, 0.018 mm AA-M12C22A31, Class II, 0.010 mm or thicker.
 - iv Color Anodic Finish: AAMA 611, AA-M12C22A42/A44, Class I, 0.018 mm AA-M12C22A32/A34, Class II, 0.010 mm or thicker.
 - v Exposed Coil-Coated Finish: Prepare, pretreat, and apply coating to exposed metal surfaces to comply with coating and resin manufacturers' written instructions.
 - 1) Two-Coat Fluoropolymer Finish: AAMA 2605. System consisting of primer and fluoropolymer color topcoat containing not less than 70 percent polyvinylidene fluoride (PVDF) resin by weight.
- b. Aluminum Extrusions and Tubes: ASTM B221 (ASTM B221M), manufacturer's standard alloy and temper for type of use, finished to match assembly where used; otherwise mill finished.
- c. Stainless Steel Sheet and Shapes: ASTM A240/A240M or ASTM A666, Type 304.
- d. Steel Shapes: ASTM A36/A36M, hot-dip galvanized according to ASTM A123/A123M unless otherwise indicated.
- e. Steel Tube: ASTM A500/A500M, round tube.
- f. Galvanized-Steel Tube: ASTM A500/A500M, round tube, hot-dip galvanized according to ASTM A123/A123M.
- g. Steel Pipe: ASTM A53/A53M, galvanized.

7. MISCELLANEOUS MATERIALS

- a. Provide materials and types of fasteners, protective coatings, sealants, and other miscellaneous items required by manufacturer for a complete installation.
- b. Acrylic Glazing: ASTM D4802, thermoformable, monolithic sheet, manufacturer's standard, Type UVA (formulated with UV absorber), Finish 1 (smooth or polished).
- c. Polycarbonate Glazing: Thermoformable, monolithic polycarbonate sheets manufactured by extrusion process, burglar-resistance rated according to UL 972 with an average impact strength of 12 to 16 ft-lbf/in. (640 to 854 J/m) of width when tested according to ASTM D256, Method A (Izod).
- d. Cellulosic-Fiber Board Insulation: ASTM C208, Type II, Grade 1, thickness as indicated.
- e. Glass-Fiber Board Insulation: ASTM C726, nominal density of 3 lb/cu. ft. (48 kg/cu. m), thermal resistivity of 4.3 deg F x h x sq. ft./Btu x in. at 75 deg F (29.8 K x m/W at 24 deg C), thickness as indicated.
- f. Polyisocyanurate Board Insulation: ASTM C1289, thickness and thermal resistivity as indicated.

- g. Wood Nailers: Softwood lumber, pressure treated with waterborne preservatives for aboveground use, acceptable to authorities having jurisdiction, containing no arsenic or chromium, and complying with AWPA C2; not less than 1-1/2 inches (38 mm) thick.
- h. Bituminous Coating: Cold-applied asphalt emulsion complying with ASTM D1187/D1187M.
- i. Underlayment:
 - i Felt: ASTM D226/D226M, Type II (No. 30), asphalt-saturated organic felt, nonperforated.
 - ii Polyethylene Sheet: 6-mil- (0.15-mm-) thick polyethylene sheet complying with ASTM D4397.
 - iii Slip Sheet: Building paper, 3 lb/100 sq. ft. (0.16 kg/sq. m) minimum, rosin sized.
 - iv Self-Adhering, High-Temperature Sheet: Minimum 30 to 40 mils (0.76 to 1.0 mm) thick, consisting of slip-resisting polyethylene-film top surface laminated to layer of butyl or SBS-modified asphalt adhesive, with release-paper backing; cold applied. Provide primer when recommended by underlayment manufacturer.
- j. Fasteners: Roof accessory manufacturer's recommended fasteners suitable for application and metals being fastened. Match finish of exposed fasteners with finish of material being fastened. Provide nonremovable fastener heads to exterior exposed fasteners. Furnish the following unless otherwise indicated:
 - i Fasteners for Zinc-Coated or Aluminum-Zinc Alloy-Coated Steel: Series 300 stainless steel or hot-dip zinc-coated steel according to ASTM A153/A153M or ASTM F2329.
 - ii Fasteners for Aluminum Sheet: Aluminum or Series 300 stainless steel.
 - iii Fasteners for Stainless Steel Sheet: Series 300 stainless steel.
- k. Gaskets: Manufacturer's standard tubular or fingered design of neoprene, EPDM, PVC, or silicone or a flat design of foam rubber, sponge neoprene, or cork.
- l. Elastomeric Sealant: ASTM C920, elastomeric polyurethane silicone polymer sealant as recommended by roof accessory manufacturer for installation indicated; low modulus; of type, grade, class, and use classifications required to seal joints and remain watertight.
- m. Butyl Sealant: ASTM C1311, single-component, solvent-release butyl rubber sealant; polyisobutylene plasticized; heavy bodied for expansion joints with limited movement.
- n. Asphalt Roofing Cement: ASTM D4586/D4586M, asbestos free, of consistency required for application.

8. GENERAL FINISH REQUIREMENTS

- a. Comply with NAAMM's "Metal Finishes Manual for Architectural and Metal Products" for recommendations for applying and designating finishes.
- b. Appearance of Finished Work: Noticeable variations in same piece are not acceptable. Variations in appearance of adjoining components are acceptable if they are within the range of approved Samples and are assembled or installed to minimize contrast.

B.7 Snow Guards

1. PERFORMANCE REQUIREMENTS

- a. Delegated Design: Engage a qualified professional engineer, as defined in "Quality Requirements," to design snow guards, including attachment to roofing material and roof deck, as applicable for attachment method, based on the following:
 - i Roof snow load.
 - ii Snow drifting
 - iii Roof slope.
 - iv Roof type.

- v Roof dimensions.
 - vi Roofing substrate type and thickness.
 - vii Snow guard type.
 - viii Snow guard fastening method and strength.
 - ix Snow guard spacing.
 - x Coefficient of Friction Between Snow and Roof Surface: 0.
 - xi Factor of Safety: 3
- b. Performance Requirements: Provide snow guards that withstand exposure to weather and resist thermally induced movement without failure, rattling, or fastener disengagement due to defective manufacture, fabrication, installation, or other defects in construction.
- i Temperature Change: 120 deg F (67 deg C), ambient; 180 deg F (100 deg C), material surfaces.
- c. Structural Performance: Snow guards shall withstand the effects of gravity loads and the following loads and stresses within limits and under conditions indicated.
- i Snow Loads: As indicated on Drawings

2. PAD-TYPE SNOW GUARDS

a. Pad-Type, Flat-Mounted Metal Snow Guards:

- i Manufacturers: Drexel Metals, Alpine SnowGuards or approved equal
- ii Material:
 - 1) ASTM B209 (ASTM B209M) aluminum sheet, not less than 0.032 inch (0.81 mm) 0.040 inch (1.02 mm) 0.050 inch (1.27 mm) 0.063 inch (1.60 mm) thick.
 - Finish: Powder coat finish complying with AAMA 2603, with a minimum dry film thickness of 1.5 mils (0.04 mm)
 - Color: Match sheet metal roofing.

3. RAIL-TYPE ALUM SNOW GUARDS

a. Rail-Type, Flat-Mounted Snow Guards:

- i Manufacturers: Drexel Metals, Alpine SnowGuards or approved equal
- ii Description: Units fabricated from metal baseplate anchored to fixed bracket and equipped with two rail(s), or pipe(s).
- iii Brackets and Baseplate: ASTM B209 (ASTM B209M) aluminum; mill finished ASTM B209 (ASTM B209M) aluminum; clear anodized
- iv Bars: ASTM B221 (ASTM B221M) aluminum; mill finish ASTM B221 (ASTM B221M) aluminum; clear anodized
 - 1) Profile: Square with integral track to accept color-matching inserts of material and finish used for metal roof.

Color to match roofing color.

- v Seam clamps: ASTM B221 (ASTM B221M) aluminum extrusion or ASTM B85/B85M aluminum casting with stainless steel set screws incorporating round nonpenetrating point; designed for use with applicable roofing system to which clamp is attached.

C Construction

C.1 Standing Seam Roof Panels

1. EXAMINATION

- a. Examine substrates, areas, and conditions, with Installer present, for compliance with requirements for installation tolerances, metal panel supports, and other conditions affecting performance of the Work.
 - i Examine primary and secondary roof framing to verify that rafters, purlins, angles, channels, and other structural panel support members and anchorages have been installed within alignment tolerances required by metal roof panel manufacturer.
 - ii Examine solid roof sheathing to verify that sheathing joints are supported by framing or blocking and that installation is within flatness tolerances required by metal roof panel manufacturer.
 - 1) Verify that air- or water-resistive barriers have been installed over sheathing or backing substrate to prevent air infiltration or water penetration.
- b. Examine roughing-in for components and systems penetrating metal panels to verify actual locations of penetrations relative to seam locations of metal panels before installation.
- c. Proceed with installation only after unsatisfactory conditions have been corrected.

2. PREPARATION

- a. Miscellaneous Supports: Install subframing, furring, and other miscellaneous panel support members and anchorages according to ASTM C754 and metal panel manufacturer's written recommendations.

3. INSTALLATION OF UNDERLAYMENT

- a. Self-Adhering Sheet Underlayment: Apply primer if required by manufacturer. Comply with temperature restrictions of underlayment manufacturer for installation. Apply at locations indicated below on Drawings, wrinkle free, in shingle fashion to shed water, and with end laps of not less than 6 inches (152 mm) staggered 24 inches (610 mm) between courses. Overlap side edges not less than 3-1/2 inches (90 mm). Extend underlayment into gutter trough. Roll laps with roller. Cover underlayment within 14 days.
 - i Apply over the entire roof surface for Towers construction.
 - 1) Roof perimeter for a distance up from eaves of 24 inches (610 mm) 36 inches (914 mm) beyond interior wall line.
 - 2) Valleys, from lowest point to highest point, for a distance on each side of 18 inches (460 mm). Overlap ends of sheets not less than 6 inches (152 mm).
 - 3) Rake edges for a distance of 18 inches (460 mm).
 - 4) Hips and ridges for a distance on each side of 12 inches (305 mm).
 - 5) Roof-to-wall intersections for a distance from wall of 18 inches (460 mm).
 - 6) Around dormers, chimneys, skylights, and other penetrating elements for a distance from element of 18 inches (460 mm).

4. INSTALLATION OF STANDING SEAM METAL ROOF PANELS

- a. Install metal panels according to manufacturer's written instructions in orientation, sizes, and locations indicated. Install panels perpendicular to supports unless otherwise indicated. Anchor metal panels and other components of the Work securely in place, with provisions for thermal and structural movement.
 - i Shim or otherwise plumb substrates receiving metal panels.
 - ii Flash and seal metal panels at perimeter of all openings. Fasten with self-tapping screws. Do not begin installation until air- or water-resistive barriers and flashings that will be concealed by metal panels are installed.

- iii Install screw fasteners in predrilled holes.
 - iv Locate and space fastenings in uniform vertical and horizontal alignment.
 - v Install flashing and trim as metal panel work proceeds.
 - vi Locate panel splices over, but not attached to, structural supports. Stagger panel splices and end laps to avoid a four-panel lap splice condition.
 - vii Align bottoms of metal panels and fasten with blind rivets, bolts, or self-tapping screws. Fasten flashings and trim around openings and similar elements with self-tapping screws.
 - viii Provide weathertight escutcheons for pipe- and conduit-penetrating panels.
- b. Fasteners:
- i Steel Panels: Use stainless steel fasteners for surfaces exposed to the exterior; use galvanized-steel fasteners for surfaces exposed to the interior.
 - ii Aluminum Panels: Use aluminum or stainless steel fasteners for surfaces exposed to the exterior; use aluminum or galvanized-steel fasteners for surfaces exposed to the interior.
 - iii Copper Panels: Use copper, stainless steel, or hardware-bronze fasteners.
 - iv Stainless Steel Panels: Use stainless steel fasteners.
- c. Anchor Clips: Anchor metal roof panels and other components of the Work securely in place, using manufacturer's approved fasteners according to manufacturers' written instructions.
- d. Metal Protection: Where dissimilar metals contact each other or corrosive substrates, protect against galvanic action as recommended in writing by metal panel manufacturer.
- e. Standing-Seam Metal Roof Panel Installation: Fasten metal roof panels to supports with concealed clips at each standing-seam joint at location, spacing, and with fasteners recommended in writing by manufacturer.
- i Install clips to supports with self-tapping fasteners.
 - ii Install pressure plates at locations indicated in manufacturer's written installation instructions.
 - iii Snap Joint: Nest standing seams and fasten together by interlocking and completely engaging factory-applied sealant.
 - iv Seamed Joint: Crimp standing seams with manufacturer-approved, motorized seamer tool so clip, metal roof panel, and factory-applied sealant are completely engaged.
 - v Watertight Installation:
 - 1) Apply a continuous ribbon of sealant or tape to seal joints of metal panels, using sealant or tape as recommend in writing by manufacturer as needed to make panels watertight.
 - 2) Provide sealant or tape between panels and protruding equipment, vents, and accessories.
 - 3) At panel splices, nest panels with minimum 6-inch (152-mm) end lap, sealed with sealant and fastened together by interlocking clamping plates.
- f. Clipless Metal Panel Installation: Fasten metal panels to supports with screw fasteners at each lapped joint at location and spacing recommended by manufacturer.
- g. Accessory Installation: Install accessories with positive anchorage to building and weathertight mounting and provide for thermal expansion. Coordinate installation with flashings and other components.

- i Install components required for a complete metal panel system including trim, copings, corners, seam covers, flashings, sealants, gaskets, fillers, closure strips, and similar items. Provide types indicated by metal roof panel manufacturers; or, if not indicated, types recommended by metal roof panel manufacturer.
- h. Flashing and Trim: Comply with performance requirements, manufacturer's written installation instructions, and SMACNA's "Architectural Sheet Metal Manual." Provide concealed fasteners where possible and set units true to line and level as indicated. Install work with laps, joints, and seams that will be permanently watertight and weather resistant.
 - i Install exposed flashing and trim that is without buckling and tool marks, and that is true to line and levels indicated, with exposed edges folded back to form hems. Install sheet metal flashing and trim to fit substrates and achieve waterproof and weather-resistant performance.
 - ii Expansion Provisions: Provide for thermal expansion of exposed flashing and trim. Space movement joints at a maximum of 10 feet (3 m) with no joints allowed within 24 inches (610 mm) of corner or intersection. Where lapped expansion provisions cannot be used or would not be sufficiently weather resistant and waterproof, form expansion joints of intermeshing hooked flanges, not less than 1 inch (25 mm) deep, filled with mastic sealant (concealed within joints).
- i. Gutters: Join sections with riveted and soldered or lapped and sealed joints. Attach gutters to eave with gutter hangers spaced not more than 36 inches (914 mm) o.c. using manufacturer's standard fasteners. Provide end closures and seal watertight with sealant. Provide for thermal expansion.
- j. Downspouts: Join sections with telescoping joints. Provide fasteners designed to hold downspouts securely 1 inch (25 mm) away from walls; locate fasteners at top and bottom and at approximately 60 inches (1524 mm) o.c. in between.
 - i Provide elbows at base of downspouts to direct water away from building.
 - ii Connect downspouts to underground drainage system indicated.
- k. Roof Curbs: Install flashing around bases where they meet metal roof panels.
- l. Pipe Flashing: Form flashing around pipe penetration and metal roof panels. Fasten and seal to metal roof panels as recommended by manufacturer.

5. ERECTION TOLERANCES

- a. Installation Tolerances: Shim and align metal panel units within installed tolerance of 1/4 inch in 20 feet (6 mm in 6 m) on slope and location lines as indicated and within 1/8-inch (3-mm) offset of adjoining faces and of alignment of matching profiles.

6. FIELD QUALITY CONTROL

- a. Manufacturer's Field Service: Engage a factory-authorized service representative to test and inspect metal roof panel installation, including accessories. Report results in writing.
- b. Remove and replace applications of metal roof panels where tests and inspections indicate that they do not comply with specified requirements.
- c. Additional tests and inspections, at contractor's expense, are performed to determine compliance of replaced or additional work with specified requirements.
- d. Prepare test and inspection reports.

7. CLEANING AND PROTECTION

- a. Remove temporary protective coverings and strippable films, if any, as metal panels are installed, unless otherwise indicated in manufacturer's written installation instructions. On completion of metal panel installation, clean finished surfaces as recommended by metal panel manufacturer. Maintain in a clean condition during construction.
- b. Replace metal panels that have been damaged or have deteriorated beyond successful repair by finish touchup or similar minor repair procedures.

C.2 Metal Soffit Panels

1. EXAMINATION

- a. Examine substrates, areas, and conditions, with Installer present, for compliance with requirements for installation tolerances, metal panel supports, and other conditions affecting performance of the Work.
 - i Examine framing to verify that girts, angles, channels, studs, and other structural panel support members and anchorage have been installed within alignment tolerances required by metal panel manufacturer.
 - ii Examine sheathing to verify that sheathing joints are supported by framing or blocking and that installation is within flatness tolerances required by metal panel manufacturer.
 - 1) Verify that air- or water-resistive barriers been installed over sheathing or backing substrate to prevent air infiltration or water penetration.
- b. Examine roughing-in for components and systems penetrating metal panels to verify actual locations of penetrations relative to seam locations of metal panels before installation.
- c. Proceed with installation only after unsatisfactory conditions have been corrected.

2. PREPARATION

- a. Miscellaneous Supports: Install subframing, furring, and other miscellaneous panel support members and anchorages according to ASTM C754 and metal panel manufacturer's written recommendations.
 - i Soffit Framing: Wire tie or clip furring channels to supports, as required to comply with requirements for assemblies indicated.

3. INSTALLATION

- a. Install metal panels according to manufacturer's written instructions in orientation, sizes, and locations indicated. Install panels perpendicular to supports unless otherwise indicated. Anchor metal panels and other components of the Work securely in place, with provisions for thermal and structural movement.
 - i Shim or otherwise plumb substrates receiving metal panels.
 - ii Flash and seal metal panels at perimeter of all openings. Fasten with self-tapping screws. Do not begin installation until air- or water-resistive barriers and flashings that will be concealed by metal panels are installed.
 - iii Install screw fasteners in predrilled holes.
 - iv Locate and space fastenings in uniform vertical and horizontal alignment.
 - v Install flashing and trim as metal panel work proceeds.
 - vi Locate panel splices over, but not attached to, structural supports. Stagger panel splices and end laps to avoid a four-panel lap splice condition.
 - vii Provide weathertight escutcheons for pipe- and conduit-penetrating panels.
- b. Fasteners:
 - i Steel Panels: Use stainless steel fasteners for surfaces exposed to the exterior; use galvanized-steel fasteners for surfaces exposed to the interior.
 - ii Aluminum Panels: Use aluminum or stainless steel fasteners for surfaces exposed to the exterior; use aluminum or galvanized-steel fasteners for surfaces exposed to the interior.
 - iii Copper Panels: Use copper, stainless steel, or hardware-bronze fasteners.
 - iv Stainless Steel Panels: Use stainless steel fasteners.
- c. Metal Protection: Where dissimilar metals contact each other or corrosive substrates, protect against galvanic action as recommended in writing by metal panel manufacturer.

- d. Lap-Seam Metal Panels: Fasten metal panels to supports with fasteners at each lapped joint at location and spacing recommended by manufacturer.
 - i Apply panels and associated items true to line for neat and weathertight enclosure.
 - ii Provide metal-backed washers under heads of exposed fasteners bearing on weather side of metal panels.
 - iii Locate and space exposed fasteners in uniform vertical and horizontal alignment. Use proper tools to obtain controlled uniform compression for positive seal without rupture of washer.
 - iv Install screw fasteners with power tools having controlled torque adjusted to compress washer tightly without damage to washer, screw threads, or panels. Install screws in predrilled holes.
- e. Watertight Installation:
 - i Apply a continuous ribbon of sealant or tape to seal lapped joints of metal panels, using sealant or tape as recommend by manufacturer on side laps of nesting-type panels and elsewhere as needed to make panels watertight.
 - ii Provide sealant or tape between panels and protruding equipment, vents, and accessories.
 - iii At panel splices, nest panels with minimum 6-inch (152-mm) end lap, sealed with sealant and fastened together by interlocking clamping plates.
- f. Accessory Installation: Install accessories with positive anchorage to building and weathertight mounting and provide for thermal expansion. Coordinate installation with flashings and other components.
 - i Install components required for a complete metal panel system including trim, corners, seam covers, flashings, sealants, gaskets, fillers, closure strips, and similar items. Provide types indicated by metal panel manufacturer; or, if not indicated, provide types recommended by metal panel manufacturer.
- g. Flashing and Trim: Comply with performance requirements, manufacturer's written installation instructions, and SMACNA's "Architectural Sheet Metal Manual." Provide concealed fasteners where possible and set units true to line and level as indicated. Install work with laps, joints, and seams that are permanently watertight.
 - i Install exposed flashing and trim that is without buckling, and tool marks, and that is true to line and levels indicated, with exposed edges folded back to form hems. Install sheet metal flashing and trim to fit substrates and to achieve waterproof performance.
 - ii Expansion Provisions: Provide for thermal expansion of exposed flashing and trim. Space movement joints at a maximum of 10 feet (3 m) with no joints allowed within 24 inches (610 mm) of corner or intersection. Where lapped expansion provisions cannot be used or would not be waterproof, form expansion joints of intermeshing hooked flanges, not less than 1 inch (25 mm) deep, filled with mastic sealant (concealed within joints).

4. CLEANING AND PROTECTION

- a. Remove temporary protective coverings and strippable films, if any, as metal panels are installed unless otherwise indicated in manufacturer's written installation instructions. On completion of metal panel installation, clean finished surfaces as recommended by metal panel manufacturer. Maintain in a clean condition during construction.
- b. After metal panel installation, clear weep holes and drainage channels of obstructions, dirt, and sealant.
- c. Replace metal panels that have been damaged or have deteriorated beyond successful repair by finish touchup or similar minor repair procedures.

C.3 EPDM Roofing

1. EXAMINATION

- a. Examine substrates, areas, and conditions, with Installer present, for compliance with requirements and other conditions affecting performance of the Work.
 - i. Verify that roof openings and penetrations are in place, curbs are set and braced, and roof-drain bodies are securely clamped in place.
 - ii. Verify that wood blocking, curbs, and nailers are securely anchored to roof deck at penetrations and terminations and that nailers match thicknesses of insulation.
 - iii. Verify that surface plane flatness and fastening of steel roof deck complies with requirements in Section "Steel Decking."
 - iv. Verify that minimum concrete drying period recommended by roofing system manufacturer has passed.
 - v. Verify that concrete substrate is visibly dry and free of moisture, and that minimum concrete internal relative humidity is not more than 75 percent, or as recommended by roofing system manufacturer when tested according to ASTM F2170.
 - 1) Test Frequency: One test probe per each 1000 sq. ft. (93 sq. m), or portion thereof, of roof deck, with not less than three test probes.
 - 2) Submit test reports within 24 hours of performing tests.
 - vi. Verify that concrete-curing compounds that will impair adhesion of roofing components to roof deck have been removed.
 - vii. Verify that joints in precast concrete roof decks have been grouted flush with top of concrete.
 - viii. Verify that minimum curing period recommended by roof system manufacturer for lightweight insulating concrete roof decks has passed.

2. PREPARATION

- a. Clean substrate of dust, debris, moisture, and other substances detrimental to roofing system installation according to roofing system manufacturer's written instructions. Remove sharp projections.
- b. Prevent materials from entering and clogging roof drains and conductors and from spilling or migrating onto surfaces of other construction. Remove roof-drain plugs when no work is taking place or when rain is forecast.
- c. Perform fastener-pullout tests according to roof system manufacturer's written instructions.
 - i. Submit test result within 24 hours of performing tests.
 - 1) Include manufacturer's requirements for any revision to previously submitted fastener patterns required to achieve specified wind uplift requirements.
- d. Install sound-absorbing insulation strips according to acoustical roof deck manufacturer's written instructions.

3. INSTALLATION OF ROOFING, GENERAL

- i. Install roofing system according to roofing system manufacturer's written instructions, SPRI's Directory of Roof Assemblies assembly requirements, and FM Global Property Loss Prevention Data Sheet 1-29.
- ii. Complete terminations and base flashings and provide temporary seals to prevent water from entering completed sections of roofing system at end of workday or when rain is forecast. Remove and discard temporary seals before beginning work on adjoining roofing.
- iii. Install roof membrane and auxiliary materials to tie in to existing roofing to maintain weathertightness of transition and to not void warranty for existing roofing system.

- iv Coordinate installation and transition of roofing system component serving as an air barrier with air barrier specified under Section "Modified Bituminous Sheet Air Barriers." Section "Nonbituminous Self-Adhering Sheet Air Barriers." Section "Fluid-Applied Membrane Air Barriers."

4. INSTALLATION OF SUBSTRATE BOARD

- a. Install substrate board with long joints in continuous straight lines, with end joints staggered not less than 24 inches (610 mm) in adjacent rows.
 - i At steel roof decks, install substrate board at right angle to flutes of deck.
 - 1) Locate end joints over crests of steel roof deck.
 - ii Tightly butt substrate boards together.
 - iii Cut substrate board to fit tight around penetrations and projections, and to fit tight to intersecting sloping roof decks.
 - iv Fasten substrate board to top flanges of steel deck according to recommendations in FM Approvals' RoofNav listed roof assembly requirements for specified Windstorm Resistance Classification SPRI's Directory of Roof Assemblies listed roof assembly requirements for specified Wind Uplift Load Capacity and FM Global Property Loss Prevention Data Sheet 1-29.
 - v Fasten substrate board to top flanges of steel deck to resist uplift pressure at corners, perimeter, and field of roof according to roofing system manufacturers' written instructions.
 - vi Loosely lay substrate board over roof deck.

5. INSTALLATION OF VAPOR RETARDER

- a. Polyethylene Film: Loosely lay polyethylene-film vapor retarder in a single layer over area to receive vapor retarder, side and end lapping each sheet a minimum of 2 and 6 inches (50 and 150 mm), respectively.
 - i Extend vertically up parapet walls and projections to a minimum height equal to height of insulation and cover board.
 - ii Continuously seal side and end laps with tape adhesive.
- b. Laminate Sheet: Loosely lay laminate-sheet vapor retarder in a single layer over area to receive vapor retarder, side and end lapping each sheet a minimum of 2 and 6 inches (50 and 150 mm), respectively.
 - i Extend vertically up parapet walls and projections to a minimum height equal to height of insulation and cover board.
 - ii Continuously seal side and end laps with tape.
- c. Self-Adhering-Sheet Vapor Retarder: Prime substrate if required by manufacturer. Install self-adhering-sheet vapor retarder over area to receive vapor retarder, side and end lapping each sheet a minimum of 3-1/2 and 6 inches (90 and 150 mm), respectively.
 - i Extend vertically up parapet walls and projections to a minimum height equal to height of insulation and cover board.
 - ii Seal laps by rolling.
- d. Completely seal vapor retarder at terminations, obstructions, and penetrations to prevent air movement into roofing system.

6. INSTALLATION OF INSULATION

- a. Coordinate installing roofing system components so insulation is not exposed to precipitation or left exposed at end of workday.
- b. Comply with roofing system and insulation manufacturer's written instructions for installing roof insulation.

c. Installation Over Metal Decking:

- i Install base layer of insulation with joints staggered not less than 24 inches (610 mm) in adjacent rows end joints staggered not less than 12 inches (305 mm) in adjacent rows and with long joints continuous at right angle to flutes of decking.
 - 1) Locate end joints over crests of decking.
- ii Install upper layers of insulation and tapered insulation with joints of each layer offset not less than 12 inches (305 mm) from previous layer of insulation.
 - 1) Staggered end joints within each layer not less than 24 inches (610 mm) in adjacent rows.
 - 2) Install with long joints continuous and with end joints staggered not less than 12 inches (305 mm) in adjacent rows.
 - 3) Trim insulation neatly to fit around penetrations and projections, and to fit tight to intersecting sloping roof decks.
 - 4) Make joints between adjacent insulation boards not more than 1/4 inch (6 mm) in width.
 - 5) At internal roof drains, slope insulation to create a square drain sump with each side equal to the diameter of the drain bowl plus 24 inches (610 mm).
 - 6) Trim insulation so that water flow is unrestricted.
 - 7) Fill gaps exceeding 1/4 inch (6 mm) with insulation.
 - 8) Cut and fit insulation within 1/4 inch (6 mm) of nailers, projections, and penetrations.
 - 9) Loosely lay each layer of insulation units over substrate.
 - 10) Adhere each layer of insulation to substrate using adhesive according to FM Approvals' RoofNav listed roof assembly requirements for specified Windstorm Resistance Classification SPRI's Directory of Roof Assemblies listed roof assembly requirements for specified Wind Uplift Load Capacity and FM Global Property Loss Prevention Data Sheet 1-29, as follows:
 - Set each layer of insulation in ribbons of bead-applied insulation adhesive, firmly pressing and maintaining insulation in place.
 - Set each layer of insulation in a uniform coverage of full-spread insulation adhesive, firmly pressing and maintaining insulation in place.

d. Installation Over Concrete Decks:

- i Install base layer of insulation with joints staggered not less than 24 inches (610 mm) in adjacent rows end joints staggered not less than 12 inches (305 mm) in adjacent rows.
 - 1) Where installing composite and noncomposite insulation in two or more layers, install noncomposite board insulation for bottom layer and intermediate layers, if applicable, and install composite board insulation for top layer.
 - 2) Trim insulation neatly to fit around penetrations and projections, and to fit tight to intersecting sloping roof decks.
 - 3) Make joints between adjacent insulation boards not more than 1/4 inch (6 mm) in width.
 - 4) At internal roof drains, slope insulation to create a square drain sump with each side equal to the diameter of the drain bowl plus 24 inches (610 mm).
 - Trim insulation so that water flow is unrestricted.
 - 5) Fill gaps exceeding 1/4 inch (6 mm) with insulation.

- 6) Cut and fit insulation within 1/4 inch (6 mm) of nailers, projections, and penetrations.
 - 7) Loosely lay base layer of insulation units over substrate.
 - 8) Adhere base layer of insulation to concrete roof deck vapor retarder according to FM Approvals' RoofNav listed roof assembly requirements for specified Windstorm Resistance Classification SPRI's Directory of Roof Assemblies listed roof assembly requirements for specified Wind Uplift Load Capacity and FM Global Property Loss Prevention Data Sheet 1-29, as follows:
 - Prime surface of concrete deck with asphalt primer at rate of 3/4 gal./100 sq. ft. (0.3 L/sq. m), and allow primer to dry.
 - Set insulation in a solid mopping of hot roofing asphalt, applied within plus or minus 25 deg F (14 deg C) of equiviscous temperature.
 - Set insulation in ribbons of bead-applied insulation adhesive, firmly pressing and maintaining insulation in place.
 - Set insulation in a uniform coverage of full-spread insulation adhesive, firmly pressing and maintaining insulation in place.
- ii Install upper layers of insulation and tapered insulation with joints of each layer offset not less than 12 inches (305 mm) from previous layer of insulation.
- 1) Staggered end joints within each layer not less than 24 inches (305 mm) in adjacent rows.
 - 2) Install with long joints continuous and with end joints staggered not less than 12 inches (305 mm) in adjacent rows.
 - 3) Trim insulation neatly to fit around penetrations and projections, and to fit tight to intersecting sloping roof decks.
 - 4) Make joints between adjacent insulation boards not more than 1/4 inch (6 mm) in width.
 - 5) At internal roof drains, slope insulation to create a square drain sump with each side equal to the diameter of the drain bowl plus 24 inches (610 mm).
 - Trim insulation so that water is unrestricted.
 - 6) Fill gaps exceeding 1/4 inch (6 mm) with insulation.
 - 7) Cut and fit insulation within 1/4 inch (6 mm) of nailers, projections, and penetrations.
 - 8) Loosely lay each layer of insulation units over substrate.
 - 9) Adhere each layer of insulation to substrate using adhesive according to SPRI's Directory of Roof Assemblies listed roof assembly requirements for specified Wind Uplift Load Capacity and FM Global Property Loss Prevention Data Sheet 1-29, as follows:
 - Set each layer of insulation in a solid mopping of hot roofing asphalt, applied within plus or minus 25 deg F (14 deg C) of equiviscous temperature.
 - Set each layer of insulation in ribbons of bead-applied insulation adhesive, firmly pressing and maintaining insulation in place.
 - Set each layer of insulation in a uniform coverage of full-spread insulation adhesive, firmly pressing and maintaining insulation in place.

7. INSTALLATION OF COVER BOARDS

- a. Install cover boards over insulation with long joints in continuous straight lines with end joints staggered between rows. Offset joints of insulation below a minimum of 6 inches (150 mm) in each direction.

- i Trim cover board neatly to fit around penetrations and projections, and to fit tight to intersecting sloping roof decks.
 - ii At internal roof drains, conform to slope of drain sump.
 - 1) Trim cover board so that water flow is unrestricted.
 - iii Cut and fit cover board tight to nailers, projections, and penetrations.
 - iv Loosely lay cover board over substrate.
 - v Adhere cover board to substrate using adhesive according to FM Approvals' RoofNav listed roof assembly requirements for specified Windstorm Resistance Classification SPRI's Directory of Roof Assemblies listed roof assembly requirements for specified Wind Uplift Load Capacity and FM Global Property Loss Prevention Data Sheet 1-29, as follows:
 - 1) Set cover board in a solid mopping of hot roofing asphalt, applied within plus or minus 25 deg F (14 deg C) of equiviscous temperature.
 - vi Set cover board in ribbons of bead-applied insulation adhesive, firmly pressing and maintaining insulation in place.
 - vii Set cover board in a uniform coverage of full-spread insulation adhesive, firmly pressing and maintaining insulation in place.
- b. Install slip sheet over cover board and immediately beneath roofing.
8. INSTALLATION OF ADHERED ROOF MEMBRANE
- a. Adhere roof membrane over area to receive roofing according to roofing system manufacturer's written instructions.
 - b. Unroll membrane roof membrane and allow to relax before installing.
 - c. Start installation of roofing in presence of roofing system manufacturer's technical personnel and Owner's testing and inspection agency.
 - d. Accurately align roof membrane, and maintain uniform side and end laps of minimum dimensions required by manufacturer. Stagger end laps.
 - e. Bonding Adhesive: Apply to substrate and underside of roof membrane at rate required by manufacturer, and allow to partially dry before installing roof membrane. Do not apply to splice area of roof membrane.
 - f. Fabric-Backed Roof Membrane Adhesive: Apply to substrate at rate required by manufacturer, and install fabric-backed roof membrane.
 - g. In addition to adhering, mechanically fasten roof membrane securely at terminations, penetrations, and perimeters.
 - h. Apply roof membrane with side laps shingled with slope of roof deck where possible.
 - i. Adhesive Seam Installation: Clean both faces of splice areas, apply splicing cement.
 - i Firmly roll side and end laps of overlapping roof membrane to ensure a watertight seam installation.
 - ii Apply lap sealant and seal exposed edges of roofing terminations.
 - iii Apply a continuous bead of in-seam sealant before closing splice if required by roofing system manufacturer.
 - j. Tape Seam Installation: Clean and prime both faces of splice areas, apply splice tape.
 - i Firmly roll side and end laps of overlapping roof membrane to ensure a watertight seam installation.
 - ii Apply lap sealant and seal exposed edges of roofing terminations.

- k. Factory-Applied Seam Tape Installation: Clean and prime surface to receive tape.
 - i. Firmly roll side and end laps of overlapping roof membrane to ensure a watertight seam installation.
 - ii. Apply lap sealant and seal exposed edges of roofing terminations.
 - l. Repair tears, voids, and lapped seams in roof membrane that do not comply with requirements.
 - m. Spread sealant or mastic bed over deck-drain flange at roof drains, and securely seal roof membrane in place with clamping ring.
 - n. Adhere protection sheet over roof membrane at locations indicated.
9. INSTALLATION OF SELF-ADHERING ROOF MEMBRANE
- a. Adhere roof membrane over area to receive roofing according to roofing system manufacturer's written instructions.
 - b. Unroll roof membrane and allow to relax before installing.
 - c. Start installation of roofing in presence of roofing system manufacturer's technical personnel and Owner's testing and inspection agency.
 - d. Accurately align roof membrane and maintain uniform side and end laps of minimum dimensions required by manufacturer. Stagger end laps.
 - e. Fold roof membrane to expose half of sheet width's bottom surface.
 - i. Remove release liner on exposed half of sheet.
 - ii. Roll roof membrane over substrate while avoiding wrinkles.
 - f. Fold remaining half of roof membrane to expose bottom surface.
 - i. Remove release liner on exposed half of sheet.
 - ii. Roll roof membrane over substrate while avoiding wrinkles.
 - g. In addition to adhering, mechanically fasten roof membrane securely at terminations, penetrations, and perimeter of roofing.
 - h. Apply roof membrane with side laps shingled with slope of roof deck where possible.
 - i. Adhesive Seam Installation: Clean both faces of splice areas, apply splicing cement.
 - i. Firmly roll side and end laps of overlapping roof membrane to ensure a watertight seam installation.
 - ii. Apply lap sealant and seal exposed edges of roofing terminations.
 - iii. Apply a continuous bead of in-seam sealant before closing splice if required by roofing system manufacturer.
 - j. Tape Seam Installation: Clean and prime both faces of splice areas, apply splice tape.
 - i. Firmly roll side and end laps of overlapping roof membrane to ensure a watertight seam installation.
 - ii. Apply lap sealant and seal exposed edges of roofing terminations.
 - k. Factory-Applied Seam Tape Installation: Clean and prime surface to receive tape.
 - i. Firmly roll side and end laps of overlapping roof membrane to ensure a watertight seam installation.
 - ii. Apply lap sealant and seal exposed edges of roofing terminations.
 - l. Repair tears, voids, and lapped seams in roof membrane that do not comply with requirements.

- m. Spread sealant or mastic bed over deck-drain flange at roof drains, and securely seal roof membrane in place with clamping ring.
- n. Adhere protection sheet over roof membrane at locations indicated.

10. INSTALLATION OF MECHANICALLY FASTENED ROOF MEMBRANE

- a. Mechanically fasten roof membrane over area to receive roofing according to roofing system manufacturer's written instructions.
- b. Unroll roofing membrane and allow to relax before installing.
- c. For in-splice attachment, install roof membrane with long dimension perpendicular to steel roof deck flutes.
- d. Start installation of roofing in presence of roofing system manufacturer's technical personnel and Owner's testing and inspection agency.
- e. Accurately align roof membrane, and maintain uniform side and end laps of minimum dimensions required by manufacturer. Stagger end laps.
- f. Mechanically fasten or adhere roof membrane securely at terminations, penetrations, and perimeter of roofing.
- g. Apply roof membrane with side laps shingled with slope of roof deck where possible.
- h. Adhesive Seam Installation: Clean both faces of splice areas, apply splicing cement.
 - i. Firmly roll side and end laps of overlapping roof membrane to ensure a watertight seam installation.
 - ii. Apply lap sealant and seal exposed edges of roofing terminations.
 - iii. Apply a continuous bead of in-seam sealant before closing splice if required by roofing system manufacturer.
- i. Tape Seam Installation: Clean and prime both faces of splice areas, apply splice tape.
 - i. Firmly roll side and end laps of overlapping roof membrane to ensure a watertight seam installation.
 - ii. Apply lap sealant and seal exposed edges of roofing terminations.
- j. Factory-Applied Seam Tape Installation: Clean and prime surface to receive tape.
 - i. Firmly roll side and end laps of overlapping roof membrane to ensure a watertight seam installation.
 - ii. Apply lap sealant and seal exposed edges of roofing terminations.
- k. Repair tears, voids, and lapped seams in roof membrane that do not comply with requirements.
- l. Spread sealant or mastic bed over deck-drain flange at roof drains, and securely seal roof membrane in place with clamping ring.
- m. In-Splice Attachment: Secure one edge of roof membrane using fastening plates or metal battens centered within splice, and mechanically fasten roof membrane to roof deck. Field splice seam.
- n. Through-Membrane Attachment: Secure roofing using fastening plates or metal battens, and mechanically fasten roof membrane to roof deck. Cover battens and fasteners with a continuous cover strip.
- o. Adhere protection sheet over roof membrane at locations indicated.

11. INSTALLATION OF BASE FLASHING

- a. Install sheet flashings and preformed flashing accessories and adhere to substrates according to roofing system manufacturer's written instructions.

- b. Apply bonding adhesive to substrate and underside of sheet flashing at required rate and allow to partially dry. Do not apply to seam area of flashing.
- c. Flash penetrations and field-formed inside and outside corners with cured or uncured sheet flashing.
- d. Clean splice areas, apply splicing cement, and firmly roll side and end laps of overlapping sheets to ensure a watertight seam installation. Apply lap sealant and seal exposed edges of sheet flashing terminations.
- e. Terminate and seal top of sheet flashings and mechanically anchor to substrate through termination bars.

12. INSTALLATION OF COATINGS

- a. Apply coatings to roof membrane and base flashings according to manufacturer's written recommendations, by spray, roller, or other suitable application method.

13. FIELD QUALITY CONTROL

- a. Testing Agency: Owner will engage Engage a qualified testing agency to inspect substrate conditions, surface preparation, roof membrane application, sheet flashings, protection, and drainage components, and to furnish reports to Architect.
- b. Perform the following tests:
 - i. Flood Testing: Flood test each roofing area for leaks, according to recommendations in ASTM D5957, after completing roofing and flashing. Install temporary containment assemblies, plug or dam drains, and flood with potable water.
 - 1) Perform tests before overlying construction is placed.
 - 2) Flood to an average depth of 2-1/2 inches (65 mm) with a minimum depth of 1 inch (25 mm) and not exceeding a depth of 4 inches (100 mm). Maintain 2 inches (50 mm) of clearance from top of base flashing.
 - 3) Flood each area for 24 48 72 hours.
 - 4) After flood testing, repair leaks, repeat flood tests, and make further repairs until roofing and flashing installations are watertight.
 - Cost of retesting is contractor's responsibility.
 - 5) Testing agency to prepare survey report indicating locations initial leaks, if any, and final survey report.
 - ii. Infrared Thermography: Testing agency surveys entire roof area using infrared color thermography according to ASTM C1153.
 - 1) Perform tests before overlying construction is placed.
 - 2) After infrared scan, locate specific areas of leaks by electrical capacitance/impedance testing or nuclear hydrogen detection tests.
 - 3) After testing, repair leaks, repeat tests, and make further repairs until roofing and flashing installations are watertight.
 - Cost of retesting is contractor's responsibility.
 - 4) Testing agency to prepare survey report of initial scan indicating locations of entrapped moisture, if any.
 - iii. Electrical Capacitance/Impedance Testing: Testing agency surveys entire roof area for entrapped water within roof assembly according to ASTM D7954/D7954M.
 - 1) Perform tests before overlying construction is placed.
 - 2) After testing, repair leaks, repeat tests, and make further repairs until roofing and flashing installations are watertight.
 - Cost of retesting is contractor's responsibility.

- 3) Testing agency to prepare survey report indicating locations of entrapped moisture, if any.
- iv Nuclear Hydrogen Detection Testing: Testing agency surveys entire roof area for entrapped water within roof assembly according to ANSI/SPRI/RCI NT-1.
 - 1) Perform tests before overlying construction is placed.
 - 2) After testing, repair leaks, repeat tests, and make further repairs until roofing and flashing installations are watertight.
 - Cost of retesting is contractor's responsibility.
 - 3) Testing agency to prepare survey report indicating locations of entrapped moisture, if any.
- c. Final Roof Inspection: Arrange for roofing system manufacturer's technical personnel to inspect roofing installation on completion, in presence of Architect, and to prepare inspection report.
- d. Repair or remove and replace components of roofing system where inspections indicate that they do not comply with specified requirements.
- e. Additional testing and inspecting, at contractor's expense, will be performed to determine if replaced or additional work complies with specified requirements.

14. PROTECTING AND CLEANING

- a. Protect roofing system from damage and wear during remainder of construction period. When remaining construction does not affect or endanger roofing system, inspect roofing system for deterioration and damage, describing its nature and extent in a written report, with copies to Architect and Owner.
- b. Correct deficiencies in or remove roofing system that does not comply with requirements, repair substrates, and repair or reinstall roofing system to a condition free of damage and deterioration at time of Substantial Completion and according to warranty requirements.
- c. Clean overspray and spillage from adjacent construction using cleaning agents and procedures recommended by manufacturer of affected construction.

15. ROOFING INSTALLER'S WARRANTY

- a. WHEREAS _____ of _____, herein called the "Roofing Installer," has performed roofing and associated work ("work") on the following project:
 - i Owner: <Insert name of Owner>.
 - ii Owner Address: <Insert address>.
 - iii Building Name/Type: <Insert information>.
 - iv Building Address: <Insert address>.
 - v Area of Work: <Insert information>.
 - vi Acceptance Date: _____.
 - vii Warranty Period: <Insert time>.
 - viii Expiration Date: _____.
- b. AND WHEREAS Roofing Installer has contracted (either directly with Owner or indirectly as a subcontractor) to warrant said work against leaks and faulty or defective materials and workmanship for designated Warranty Period,

- c. NOW THEREFORE Roofing Installer hereby warrants, subject to terms and conditions herein set forth, that during Warranty Period Roofing Installer will, at Roofing Installer's own cost and expense, make or cause to be made such repairs to or replacements of said work as are necessary to correct faulty and defective work and as are necessary to maintain said work in a watertight condition.
- d. This Warranty is made subject to the following terms and conditions:
- i Specifically excluded from this Warranty are damages to work and other parts of the building, and to building contents, caused by:
 - 1) lightning;
 - 2) peak gust wind speed exceeding <120 mph (m/s)>;
 - 3) fire;
 - 4) failure of roofing system substrate, including cracking, settlement, excessive deflection, deterioration, and decomposition;
 - 5) faulty construction of parapet walls, copings, chimneys, skylights, vents, equipment supports, and other edge conditions and penetrations of the work;
 - 6) vapor condensation on bottom of roofing; and
 - 7) activity on roofing by others, including construction contractors, maintenance personnel, other persons, and animals, whether authorized or unauthorized by Owner.
 - ii When work has been damaged by any of foregoing causes, Warranty shall be null and void until such damage has been repaired by Roofing Installer and until cost and expense thereof have been paid by Owner or by another responsible party so designated.
 - iii Roofing Installer is responsible for damage to work covered by this Warranty but is not liable for consequential damages to building or building contents resulting from leaks or faults or defects of work.
 - iv During Warranty Period, if Owner allows alteration of work by anyone other than Roofing Installer, including cutting, patching, and maintenance in connection with penetrations, attachment of other work, and positioning of anything on roof, this Warranty shall become null and void on date of said alterations, but only to the extent said alterations affect work covered by this Warranty. If Owner engages Roofing Installer to perform said alterations, Warranty shall not become null and void unless Roofing Installer, before starting said work, shall have notified Owner in writing, showing reasonable cause for claim, that said alterations would likely damage or deteriorate work, thereby reasonably justifying a limitation or termination of this Warranty.
 - v During Warranty Period, if original use of roof is changed and it becomes used for, but was not originally specified for, a promenade, work deck, spray-cooled surface, flooded basin, or other use or service more severe than originally specified, this Warranty shall become null and void on date of said change, but only to the extent said change affects work covered by this Warranty.
 - vi Owner shall promptly notify Roofing Installer of observed, known, or suspected leaks, defects, or deterioration and shall afford reasonable opportunity for Roofing Installer to inspect work and to examine evidence of such leaks, defects, or deterioration.
 - vii This Warranty is recognized to be the only warranty of Roofing Installer on said work and shall not operate to restrict or cut off Owner from other remedies and resources lawfully available to Owner in cases of roofing failure. Specifically, this Warranty shall not operate to relieve Roofing Installer of responsibility for performance of original work according to requirements of the Contract Documents, regardless of whether Contract was a contract directly with owner or a subcontract with owner's general contractor.

- e. IN WITNESS THEREOF, this instrument has been duly executed this _____ day of _____, _____.
- i Authorized Signature: _____.
 - ii Name: _____.
 - iii Title: _____.

C.4 Sheet Metal Flashing and Trim

1. EXAMINATION

- a. Examine substrates, areas, and conditions, with installer present, for compliance with requirements for installation tolerances, substrate, and other conditions affecting performance of the Work.
 - i Verify compliance with requirements for installation tolerances of substrates.
 - ii Verify that substrate is sound, dry, smooth, clean, sloped for drainage, and securely anchored.
 - iii Verify that air- or water-resistant barriers have been installed over sheathing or backing substrate to prevent air infiltration or water penetration.
- b. Proceed with installation only after unsatisfactory conditions have been corrected.

2. INSTALLATION OF UNDERLAYMENT

- a. Felt Underlayment: Install felt underlayment, wrinkle free, using adhesive to minimize use of mechanical fasteners under sheet metal flashing and trim.
 - i Install in shingle fashion to shed water.
 - ii Lap joints not less than 2 inches (50 mm).
- b. Synthetic Underlayment: Install synthetic underlayment, wrinkle free, according to manufacturers' written instructions, and using adhesive where possible to minimize use of mechanical fasteners under sheet metal.
 - i Lap horizontal joints not less than 4 inches (100 mm).
 - ii Lap end joints not less than 12 inches (300 mm).
- c. Self-Adhering, High-Temperature Sheet Underlayment:
 - i Install self-adhering, high-temperature sheet underlayment; wrinkle free.
 - ii Prime substrate if recommended by underlayment manufacturer.
 - iii Comply with temperature restrictions of underlayment manufacturer for installation; use primer for installing underlayment at low temperatures.
 - iv Apply in shingle fashion to shed water, with end laps of not less than 6 inches (150 mm) staggered 24 inches (600 mm) between courses.
 - v Overlap side edges not less than 3-1/2 inches (90 mm). Roll laps and edges with roller.
 - vi Roll laps and edges with roller.
 - vii Cover underlayment within 14 days.
- d. Install slip sheet, wrinkle free, over underlayment directly on substrate before installing sheet metal flashing and trim.
 - i Install in shingle fashion to shed water.
 - ii Lapp joints not less than 4 inches (100 mm).

3. INSTALLATION, GENERAL

- a. Install sheet metal flashing and trim to comply with details indicated and recommendations of cited sheet metal standard that apply to installation characteristics required unless otherwise indicated on Drawings.
 - i Install fasteners, solder, protective coatings, separators, sealants, and other miscellaneous items as required to complete sheet metal flashing and trim system.
 - ii Install sheet metal flashing and trim true to line, levels, and slopes. Provide uniform, neat seams with minimum exposure of solder welds sealant.
 - iii Anchor sheet metal flashing and trim and other components of the Work securely in place, with provisions for thermal and structural movement.
 - iv Install sheet metal flashing and trim to fit substrates and to result in watertight performance.
 - v Install continuous cleats with fasteners spaced not more than 12 inches (300 mm) o.c.
 - vi Space individual cleats not more than 12 inches (300 mm) apart. Attach each cleat with at least two fasteners. Bend tabs over fasteners.
 - vii Install exposed sheet metal flashing and trim with limited oil-canning, and free of buckling and tool marks.
 - viii Do not field cut sheet metal flashing and trim by torch.
 - ix Do not use graphite pencils to mark metal surfaces.
- b. Metal Protection: Where dissimilar metals contact each other, or where metal contacts pressure-treated wood or other corrosive substrates, protect against galvanic action or corrosion by painting contact surfaces with bituminous coating or by other permanent separation as recommended by sheet metal manufacturer or cited sheet metal standard.
 - i Coat concealed side of uncoated-aluminum and sheet metal flashing and trim with bituminous coating where flashing and trim contact wood, ferrous metal, or cementitious construction.
 - ii Underlayment: Where installing sheet metal flashing and trim directly on cementitious or wood substrates, install underlayment and cover with slip sheet.
- c. Expansion Provisions: Provide for thermal expansion of exposed flashing and trim.
 - i Space movement joints at maximum of 10 feet (3 m) with no joints within 24 inches (600 mm) of corner or intersection.
 - ii Form expansion joints of intermeshing hooked flanges, not less than 1 inch (25 mm) deep, filled with sealant concealed within joints.
 - iii Use lapped expansion joints only where indicated on Drawings.
- d. Fasteners: Use fastener sizes that penetrate wood blocking or sheathing not less than 1-1/4 inches (32 mm) for nails and not less than 3/4 inch (19 mm) for wood screws substrate not less than recommended by fastener manufacturer to achieve maximum pull-out resistance .
- e. Conceal fasteners and expansion provisions where possible in exposed work and locate to minimize possibility of leakage. Cover and seal fasteners and anchors as required for a tight installation.
- f. Seal joints as required for watertight construction.
 - i Use sealant-filled joints unless otherwise indicated.
 - 1) Embed hooked flanges of joint members not less than 1 inch (25 mm) into sealant.
 - 2) Form joints to completely conceal sealant.

- 3) When ambient temperature at time of installation is between 40 and 70 deg F (4 and 21 deg C), set joint members for 50 percent movement each way.
 - 4) Adjust setting proportionately for installation at higher ambient temperatures.
 - Do not install sealant-type joints at temperatures below 40 deg F (4 deg C).
 - 5) Prepare joints and apply sealants to comply with requirements in Section "Joint Sealants."
- g. Soldered Joints: Clean surfaces to be soldered, removing oils and foreign matter.
- i Pretin edges of sheets with solder to width of 1-1/2 inches (38 mm); however, reduce pretinning where pretinned surface would show in completed Work.
 - ii Do not solder metallic-coated steel and aluminum sheet.
 - iii Do not pretin zinc-tin alloy-coated copper.
 - iv Do not use torches for soldering.
 - v Heat surfaces to receive solder, and flow solder into joint.
 - 1) Fill joint completely.
 - 2) Completely remove flux and spatter from exposed surfaces.
 - vi Stainless Steel Soldering:
 - 3) Tin edges of uncoated sheets, using solder for stainless steel and acid flux.
 - 4) Promptly remove acid-flux residue from metal after tinning and soldering.
 - 5) Comply with solder manufacturer's recommended methods for cleaning and neutralization.
 - vii Copper Soldering: Tin edges of uncoated sheets, using solder for copper.
 - viii Copper-Clad Stainless Steel Soldering: Tin edges of uncoated sheets, using solder for copper-clad stainless steel.
- h. Rivets: Rivet joints in uncoated aluminum zinc where necessary for strength.

4. INSTALLATION OF ROOF-DRAINAGE SYSTEM

- a. Install sheet metal roof-drainage items to produce complete roof-drainage system according to cited sheet metal standard unless otherwise indicated. Coordinate installation of roof perimeter flashing with installation of roof-drainage system.
- b. Hanging Gutters:
 - i Join sections with riveted and soldered joints or joints sealed with sealant.
 - ii Provide for thermal expansion.
 - iii Attach gutters at eave or fascia to firmly anchor them in position.
 - iv Provide end closures and seal watertight with sealant.
 - v Slope to downspouts.
 - vi Fasten gutter spacers to front and back of gutter.
 - vii Anchor and loosely lock back edge of gutter to continuous cleat eave or apron flashing.
 - viii Anchor back of gutter that extends onto roof deck with cleats spaced not more than 24 inches (600 mm) apart.
 - ix Anchor gutter with gutter brackets straps twisted straps spaced not more than 24 inches (600 mm) 30 inches (760 mm) 36 inches (910 mm) apart to roof deck unless otherwise indicated, and loosely lock to front gutter bead.
 - x Anchor gutter with spikes and ferrules spaced not more than 24 inches (600 mm) 30 inches (760 mm) apart.

- xi Install gutter with expansion joints at locations indicated on Drawings, but not exceeding, 50 feet (15.2 m) apart. Install expansion-joint caps.
 - xii Install continuous gutter screens on gutters with noncorrosive fasteners, removable hinged to swing open for cleaning gutters.
- c. Built-in Gutters:
- i Join sections with riveted and soldered joints or joints sealed with sealant.
 - ii Provide for thermal expansion.
 - iii Slope to downspouts.
 - iv Provide end closures and seal watertight with sealant.
 - v Install underlayment layer in built-in gutter trough and extend to drip edge at eaves and under underlayment on roof sheathing.
 - 1) Lap sides minimum of 2 inches (50 mm) over underlying course.
 - 2) Lap ends minimum of 4 inches (100 mm).
 - 3) Stagger end laps between succeeding courses at least 72 inches (1830 mm).
 - 4) Fasten with roofing nails.
 - 5) Install slip sheet over underlayment.
 - vi Anchor and loosely lock back edge of gutter to continuous cleat eave or apron flashing.
 - vii Anchor back of gutter that extends onto roof deck with cleats spaced not more than 18 inches (460 mm) apart.
 - viii Install gutter with expansion joints at locations indicated on Drawings, but not exceeding, 50 feet (15.2 m) apart. Install expansion-joint caps.
- d. Downspouts:
- i Join sections with 1-1/2-inch (38-mm) telescoping joints.
 - ii Provide hangers with fasteners designed to hold downspouts securely to walls.
 - iii Locate hangers at top and bottom and at approximately 60 inches (1500 mm) o.c.
 - iv Provide elbows at base of downspout to direct water away from building.
 - v Connect downspouts to underground drainage system.
- e. Splash Pans:
- i Install where downspouts discharge on low-slope roofs.
 - ii Set in asphalt roofing cement or elastomeric sealant compatible with the substrate.
- f. Parapet Scuppers:
- i Continuously support scupper, set to correct elevation, and seal flanges to interior wall face, over cants or tapered edge strips, and under roofing membrane.
 - ii Anchor scupper closure trim flange to exterior wall and solder or seal with elastomeric sealant to scupper.
 - iii Loosely lock front edge of scupper with conductor head.
 - iv Solder or seal with elastomeric sealant exterior wall scupper flanges into back of conductor head.
- g. Conductor Heads: Anchor securely to wall, with elevation of conductor head rim at minimum of 1 inch (25 mm) below scupper or gutter discharge.
- h. Expansion-Joint Covers: Install expansion-joint covers at locations and of configuration indicated on Drawings. Lap joints minimum of 4 inches (100 mm) in direction of water flow.

5. INSTALLATION OF ROOF FLASHINGS

- a. Install sheet metal flashing and trim to comply with performance requirements, sheet metal manufacturer's written installation instructions, and cited sheet metal standard.
 - i Provide concealed fasteners where possible, and set units true to line, levels, and slopes.
 - ii Install work with laps, joints, and seams that are permanently watertight and weather resistant.
- b. Roof Edge Flashing:
 - i Install roof edge flashings according to ANSI/SPRI/FM 4435/ES-1.
 - ii Anchor to resist uplift and outward forces according to recommendations in cited sheet metal standard unless otherwise indicated. Interlock bottom edge of roof edge flashing with continuous cleat anchored to substrate at staggered 3-inch (75-mm) centers.
 - iii Anchor to resist uplift and outward forces according to recommendations in FM Global Property Loss Prevention Data Sheet 1-49 for FM Approvals' listing for required windstorm classification.
- c. Copings:
 - i Install roof edge flashings according to ANSI/SPRI/FM 4435/ES-1.
 - ii Anchor to resist uplift and outward forces according to recommendations in cited sheet metal standard unless otherwise indicated.
 - 1) Interlock exterior bottom edge of coping with continuous cleat anchored to substrate at 24-inch (600-mm) 16-inch (400-mm) centers.
 - 2) Anchor interior leg of coping with washers and screw fasteners through slotted holes at 24-inch (600-mm) centers.
 - iii Anchor to resist uplift and outward forces according to recommendations in FM Global Property Loss Prevention Data Sheet 1-49 for specified FM Approvals' listing for required windstorm classification.
- d. Pipe or Post Counterflashing: Install counterflashing umbrella with close-fitting collar with top edge flared for elastomeric sealant, extending minimum of 4 inches (100 mm) over base flashing. Install stainless steel draw band and tighten.
- e. Counterflashing: Coordinate installation of counterflashing with installation of base flashing.
 - i Insert counterflashing in reglets or receivers and fit tightly to base flashing.
 - ii Extend counterflashing 4 inches (100 mm) over base flashing.
 - iii Lap counterflashing joints minimum of 4 inches (100 mm).
 - iv Secure in waterproof manner by means of snap-in installation and sealant or lead wedges and sealant interlocking folded seam or blind rivets and sealant anchor and washer spaced at 12 inches (300 mm) o.c. along perimeter and 6 inches (150 mm) o.c. at corners areas unless otherwise indicated.
- f. Roof-Penetration Flashing: Coordinate installation of roof-penetration flashing with installation of roofing and other items penetrating roof. Seal with elastomeric butyl sealant and clamp flashing to pipes that penetrate roof.

6. INSTALLATION OF WALL FLASHINGS

- a. Install sheet metal wall flashing to intercept and exclude penetrating moisture according to cited sheet metal standard unless otherwise indicated. Coordinate installation of wall flashing with installation of wall-opening components such as windows, doors, and louvers.

- b. Opening Flashings in Frame Construction: Install continuous head, sill, jamb, and similar flashings to extend 4 inches (100 mm) beyond wall openings.

7. INSTALLATION OF MISCELLANEOUS FLASHING

- a. Equipment Support Flashing:
 - i. Coordinate installation of equipment support flashing with installation of roofing and equipment.
 - ii. Weld or seal flashing with elastomeric sealant to equipment support member.
- b. Overhead-Piping Safety Pans:
 - i. Suspend pans from structure above, independent of other overhead items such as equipment, piping, and conduit, unless otherwise indicated on Drawings.
 - ii. Pipe and install drain line to plumbing waste or drainage system.

8. INSTALLATION TOLERANCES

- a. Installation Tolerances: Shim and align sheet metal flashing and trim within installed tolerance of 1/4 inch in 20 feet (6 mm in 6 m) on slope and location lines indicated on Drawings and within 1/8-inch (3-mm) offset of adjoining faces and of alignment of matching profiles.

9. CLEANING

- a. Clean exposed metal surfaces of substances that interfere with uniform oxidation and weathering.
- b. Clean and neutralize flux materials. Clean off excess solder.
- c. Clean off excess sealants.

10. PROTECTION

- a. Remove temporary protective coverings and strippable films as sheet metal flashing and trim are installed unless otherwise indicated in manufacturer's written installation instructions.
- b. On completion of sheet metal flashing and trim installation, remove unused materials and clean finished surfaces as recommended in writing by sheet metal flashing and trim manufacturer.
- c. Maintain sheet metal flashing and trim in clean condition during construction.
- d. Replace sheet metal flashing and trim that have been damaged or that have deteriorated beyond successful repair by finish touchup or similar minor repair procedures, as determined by Architect.

C.5 Manufactured Roof Expansion Joints

1. EXAMINATION

- a. Examine joint openings, substrates, and expansion-control joint systems that interface with roof expansion joints, for suitable conditions where roof expansion joints will be installed.
- b. Proceed with installation only after unsatisfactory conditions have been corrected.

2. INSTALLATION, GENERAL

- a. Comply with manufacturer's written instructions for handling and installing roof expansion joints.
 - i. Anchor roof expansion joints securely in place, with provisions for required movement. Use fasteners, protective coatings, sealants, and miscellaneous items as required to complete roof expansion joints.
 - ii. Install roof expansion joints true to line and elevation; and without warping, jogs in alignment, buckling, or tool marks.
 - iii. Provide for linear thermal expansion of roof-expansion-joint materials.

- iv Provide uniform profile of roof expansion joint throughout its length; do not stretch or squeeze membranes.
- v Provide uniform, neat seams.
- vi Install roof expansion joints to fit substrates and to result in watertight performance.
- b. Directional Changes: Install factory-fabricated units at directional changes to provide continuous, uninterrupted, and watertight joints.
- c. Transitions to Other Expansion-Control Joint Assemblies: Coordinate installation of roof expansion joints with other exterior expansion-control joint assemblies specified in Section "Exterior Expansion Joint Cover Assemblies" to result in watertight performance. Install factory-fabricated units at transitions between roof expansion joints and exterior expansion-control joint systems.
- d. Splices: Splice roof expansion joints to provide continuous, uninterrupted, and waterproof joints.
 - i Install waterproof splices and prefabricated end dams to prevent leakage of secondary-seal membrane.
- e. Fire Barrier: Install fire barrier as required by manufacturer to provide continuous, uninterrupted fire resistance throughout length of roof expansion joint, including transitions and end joints.
- f. Metal Protection: Protect metals against galvanic action by separating dissimilar metals from contact with each other or with corrosive substrates by painting contact surfaces with bituminous coating or by other permanent separation as recommended by manufacturer.

C.6 Roof Accessories

1. EXAMINATION

- a. Examine substrates, areas, and conditions, with Installer present, to verify actual locations, dimensions, and other conditions affecting performance of the Work.
- b. Verify that substrate is sound, dry, smooth, clean, sloped for drainage, and securely anchored.
- c. Verify dimensions of roof openings for roof accessories.
- d. Proceed with installation only after unsatisfactory conditions have been corrected.

2. INSTALLATION

- a. Install roof accessories according to manufacturer's written instructions.
 - i Install roof accessories level; plumb; true to line and elevation; and without warping, jogs in alignment, buckling, or tool marks.
 - ii Anchor roof accessories securely in place so they are capable of resisting indicated loads.
 - iii Use fasteners, separators, sealants, and other miscellaneous items as required to complete installation of roof accessories and fit them to substrates.
 - iv Install roof accessories to resist exposure to weather without failing, rattling, leaking, or loosening of fasteners and seals.
- b. Metal Protection: Protect metals against galvanic action by separating dissimilar metals from contact with each other or with corrosive substrates by painting contact surfaces with bituminous coating or by other permanent separation as recommended by manufacturer.
 - i Coat concealed side of uncoated aluminum stainless steel roof accessories with bituminous coating where in contact with wood, ferrous metal, or cementitious construction.

- ii Underlayment: Where installing roof accessories directly on cementitious or wood substrates, install a course of underlayment and cover with manufacturer's recommended slip sheet.
 - iii Bed flanges in thick coat of asphalt roofing cement where required by manufacturers of roof accessories for waterproof performance.
- c. Roof Curb Installation: Install each roof curb so top surface is level.
 - d. Equipment Support Installation: Install equipment supports so top surfaces are level with each other.
3. REPAIR AND CLEANING
- a. Galvanized Surfaces: Clean field welds, bolted connections, and abraded areas and repair galvanizing according to ASTM A780/A780M.
 - b. Touch up factory-primed surfaces with compatible primer ready for field painting according to Section "Exterior Painting."
 - c. Clean exposed surfaces according to manufacturer's written instructions.
 - d. Clean off excess sealants.
 - e. Replace roof accessories that have been damaged or that cannot be successfully repaired by finish touchup or similar minor repair procedures.

C.7 Snow Guards

1. EXAMINATION
- a. Examine substrates and conditions, with Installer present, for compliance with requirements for installation tolerances, snow guard attachment, and other conditions affecting performance of the Work.
 - i Verify compatibility with and suitability of substrates, including compatibility with existing finishes or primers.
 - b. Proceed with installation only after unsatisfactory conditions have been corrected.
2. PREPARATION
- a. Clean and prepare substrates for bonding snow guards.
 - b. Prime substrates according to snow guard manufacturer's written instructions.
3. INSTALLATION
- a. Install snow guards according to manufacturer's written instructions.
 - i Space rows as indicated on Shop Drawings.
 - ii Space rows as recommended by manufacturer.
 - b. Attachment for Standing-Seam Metal Roofing:
 - i Do not use fasteners that will penetrate metal roofing or fastening methods that void metal roofing finish warranty.
 - ii Pad-Type, Flat-Mounted Snow Guards:
 - 1) Mechanically attach Adhere to metal roofing according to manufacturer's instructions.
 - 2) Solder to copper roofing according to manufacturer's instructions.
 - iii Pad-Type, Seam-Mounted Snow Guards:
 - 1) Install snow guards in straight rows.
 - 2) Secure in place using stainless steel set screws, incorporating round nonpenetrating point.

- 3) Torque set screw according to manufacturer's instructions.
- iv Rail-Type, Seam-Mounted Snow Guards:
 - 1) Install brackets to vertical ribs in straight rows.
 - 2) Secure with stainless steel set screws, incorporating round nonpenetrating point, on same side of standing seam.
 - 3) Torque set screw according to manufacturer's instructions.
 - 4) Install cross members to brackets.
- c. Attachment for Exposed Fastened Metal Roofing:
 - i Do not use fasteners that will void metal roofing finish warranty.
 - ii Pad-Type, Flat-Mounted Snow Guards:
 - 1) Adhere to metal roofing according to manufacturer's instructions.
 - 2) Mechanically fasten to metal roofing, using fasteners identical to those used to secure metal roofing to substrate.
 - 3) Solder to copper roofing according to manufacturer's instructions.
 - iii Rail-Type, Flat-Mounted Snow Guards:
 - 1) Install brackets in straight rows.
 - 2) Mechanically fasten to metal roofing, using sealant and mechanical fasteners identical to those used to secure metal roofing to substrate.
 - 3) Install cross members to brackets.

D Measurement

The department will measure Roofing and Accessories work by the square foot, acceptably completed. The quantity to be paid for will be the sum of the areas of exposed faces at the locations shown on the plans. Area will be determined from measurements taken in the plane of the exposed face of the roofing.

E Payment

The department will pay for measured quantities at the contract unit price under the following bid item:

ITEM NUMBER	DESCRIPTION	UNIT
SPV.0165.04	Roofing and Accessories	SF

Payment is full compensation for design, shop drawings, samples, mockups, testing, fabrication, and installation of roofing materials including but not limited to standing seam roof panels, soffit panels, EPDM roofing and other roof accessories.

68. Exterior Metal Panels, Item SPV.0165.05

A Description

A.1 SUMMARY

- a. Section Includes:
 - i Exterior Foamed-insulation-core metal wall panels smooth finish.
 - ii Exterior Foamed-insulation-core metal wall panels with horizontal ribbed appearance
 - iii Interior L shaped non insulated steel cladding panels - knee wall under curtain walls
 - iv 9'-1" high interior laminated aluminum panels to full high gypsum board walls at public areas.

- b. Related Requirements:
 - i "Soffit Panels" for metal panels used in horizontal soffit applications.

A.2 PREINSTALLATION MEETINGS

- a. Preinstallation Conference: Conduct conference at Project site
 - i Meet with Owner, Architect, Owner's insurer if applicable, metal panel Installer, metal panel manufacturer's representative, structural-support Installer, and installers whose work interfaces with or affects metal panels, including installers of doors, windows, and louvers.
 - ii Review and finalize construction schedule and verify availability of materials, Installer's personnel, equipment, and facilities needed to make progress and avoid delays.
 - iii Review methods and procedures related to metal panel installation, including manufacturer's written instructions.
 - iv Examine support conditions for compliance with requirements, including alignment between and attachment to structural members.
 - v Review flashings, special siding details, wall penetrations, openings, and condition of other construction that affect metal panels.
 - vi Review governing regulations and requirements for insurance, certificates, and tests and inspections if applicable.
 - vii Review temporary protection requirements for metal panel assembly during and after installation.
 - viii Review procedures for repair of metal panels damaged after installation.
 - ix Document proceedings, including corrective measures and actions required, and furnish copy of record to each participant.

A.3 ACTION SUBMITTALS

- a. Product Data: For each type of product.
 - i Include construction details, material descriptions, dimensions of individual components and profiles, and finishes for each type of panel and accessory.
- b. Sustainable Design Submittals:
- c. Shop Drawings:
 - i Include fabrication and installation layouts of metal panels; details of edge conditions, joints, panel profiles, corners, anchorages, attachment system, trim, flashings, closures, and accessories; and special details.
 - ii Accessories: Include details of the flashing, trim, and anchorage systems, at a scale of not less than 1-1/2 inches per 12 inches (1:10).
- d. Samples for Initial Selection: For each type of metal panel indicated with factory-applied color finishes.
 - i Include similar Samples of trim and accessories involving color selection.
- e. Samples for Verification: For each type of exposed finish, prepared on Samples of size indicated below.
 - i Metal Panels: 12 inches (305 mm) long by actual panel width. Include fasteners, closures, and other metal panel accessories.

A.4 INFORMATIONAL SUBMITTALS

- a. Qualification Data: For Installer.
- b. Product Test Reports: For each product, tests performed by a qualified testing agency.

- c. Field quality-control reports.
- d. Sample Warranties: For special warranties.

A.5 CLOSEOUT SUBMITTALS

- a. Maintenance Data: For metal panels to include in maintenance manuals.

A.6 QUALITY ASSURANCE

- a. Installer Qualifications: An entity that employs installers and supervisors who are trained and approved by manufacturer.
- b. Mockups: Build mockups to verify selections made under Sample submittals and to demonstrate aesthetic effects and set quality standards for fabrication and installation.
 - i. Build mockup of typical metal panel assembly as shown on Drawings, including corner, soffits, supports, attachments, and accessories.
 - ii. Water-Spray Test: Conduct water-spray test of metal panel assembly mockup, testing for water penetration according to AAMA 501.2.
 - iii. Approval of mockups does not constitute approval of deviations from the Contract Documents contained in mockups unless Architect specifically approves such deviations in writing.
 - iv. Subject to compliance with requirements, approved mockups may become part of the completed Work if undisturbed at time of Substantial Completion.

A.7 DELIVERY, STORAGE, AND HANDLING

- a. Deliver components, metal panels, and other manufactured items so as not to be damaged or deformed. Package metal panels for protection during transportation and handling.
- b. Unload, store, and erect metal panels in a manner to prevent bending, warping, twisting, and surface damage.
- c. Stack metal panels horizontally on platforms or pallets, covered with suitable weathertight and ventilated covering. Store metal panels to ensure dryness, with positive slope for drainage of water. Do not store metal panels in contact with other materials that might cause staining, denting, or other surface damage.
- d. Retain strippable protective covering on metal panels during installation.

A.8 FIELD CONDITIONS

- a. Weather Limitations: Proceed with installation only when existing and forecasted weather conditions permit assembly of metal panels to be performed according to manufacturers' written instructions and warranty requirements.

A.9 COORDINATION

- a. Coordinate metal panel installation with rain drainage work, flashing, trim, construction of soffits, and other adjoining work to provide a leakproof, secure, and noncorrosive installation.

A.10 WARRANTY

- a. Special Warranty: Manufacturer's standard form in which manufacturer agrees to repair or replace components of metal panel systems that fail in materials or workmanship within specified warranty period.
 - i. Failures include, but are not limited to, the following:
 - 1) Structural failures including rupturing, cracking, or puncturing.
 - 2) Deterioration of metals and other materials beyond normal weathering.
 - ii. Warranty Period: Two years from date of Substantial Completion.

- b. Special Warranty on Panel Finishes: Manufacturer's standard form in which manufacturer agrees to repair finish or replace metal panels that show evidence of deterioration of factory-applied finishes within specified warranty period.
 - i Exposed Panel Finish: Deterioration includes, but is not limited to, the following:
 - 3) Color fading more than 5 Hunter units when tested according to ASTM D2244.
 - 4) Chalking in excess of a No. 8 rating when tested according to ASTM D4214.
 - 5) Cracking, checking, peeling, or failure of paint to adhere to bare metal.
 - ii Finish Warranty Period: 10 years from date of Substantial Completion.

B Materials

B.1 PERFORMANCE REQUIREMENTS

- i Structural Performance: Provide metal panel systems capable of withstanding the effects of the following loads, based on testing according to ASTM E72:
 - ii Wind Loads: As indicated on Drawings.
 - iii Other Design Loads: As indicated on Drawings
 - iv Deflection Limits: For wind loads, no greater than 1/180
- b. Air Infiltration: Air leakage of not more than 0.06 cfm/sq. ft. (0.3 L/s per sq. m) when tested according to ASTM E283 at the following test-pressure difference:
 - i Test-Pressure Difference: 1.57 lbf/sq. ft. (75 Pa)
- c. Water Penetration under Static Pressure: No water penetration when tested according to ASTM E331 at the following test-pressure difference:
 - i Test-Pressure Difference: 2.86 lbf/sq. ft. (137 Pa)
- d. Thermal Movements: Allow for thermal movements from ambient and surface temperature changes by preventing buckling, opening of joints, overstressing of components, failure of joint sealants, failure of connections, and other detrimental effects. Base calculations on surface temperatures of materials due to both solar heat gain and nighttime-sky heat loss.
 - i Temperature Change (Range): 120 deg F (67 deg C), ambient.
- e. Fire-Test-Response Characteristics: Provide metal wall panels and system components with the following fire-test-response characteristics, as determined by testing identical panels and system components per test method indicated below by UL or another testing and inspecting agency acceptable to authorities having jurisdiction. Identify products with appropriate markings of applicable testing agency.
 - i Fire-Resistance Characteristics: Provide materials and construction tested for fire resistance per ASTM E119.
 - ii Intermediate-Scale Multistory Fire Test: Tested mockup, representative of completed multistory wall assembly of which wall panel is a part, complies with NFPA 285 for test method and required fire-test-response characteristics of exterior non-load-bearing wall panel assemblies.
 - iii Radiant Heat Exposure: No ignition when tested according to NFPA 268.
 - iv Potential Heat: Acceptable level when tested according to NFPA 259.
 - v Surface-Burning Characteristics: Provide wall panels with a flame-spread index of 25 or less and a smoke-developed index of 450 or less, per ASTM E84.

B.2 FOAMED-INSULATION-CORE METAL WALL PANELS

1. General: Provide factory-formed and -assembled metal wall panels fabricated from two metal facing sheets and insulation core foamed in place during fabrication, and with joints between panels designed to form weathertight seals. Include accessories required for weathertight installation.
 - a. Insulation Core: Modified isocyanurate or polyurethane foam using a non-CFC blowing agent, with maximum flame-spread and smoke-developed indexes of 25 and 450, respectively.
 - i Closed-Cell Content: 90 percent when tested according to ASTM D6226.
 - ii Density: 2.0 to 2.6 lb/cu. ft. (32 to 42 kg/cu. m) when tested according to ASTM D1622.
 - iii Compressive Strength: Minimum 20 psi (140 kPa) when tested according to ASTM D1621.
 - iv Shear Strength: 26 psi (179 kPa) when tested according to ASTM C273/C273M.
 - b. Concealed-Fastener, Foamed-Insulation-Core Metal Wall Panels >: Formed with tongue-and-groove panel edges; designed for sequential installation by interlocking panel edges and mechanically attaching panels to supports using concealed clips or fasteners.
 - i Manufacturer: CENTRIA or Approved Equal
 - ii Backer Board: On back side of exterior facing.
 - iii Snap-on Batten: Same material, finish, and color as exterior facings of wall panels.
 - iv Panel Coverage: 36 inches (914 mm) 40 inches (1016 mm) nominal.
 - v Panel Thickness: 2.0 inches (51 mm)
 - vi Thermal-Resistance Value (R-Value): <20> according to ASTM C1363.

B.3 NON INSULATED METAL PANELS

1. General: Fabricate products from sheet metal without pitting, seam marks, roller marks, stains, discolorations, or other imperfections where exposed to view on finished units.
2. Aluminum Sheet: Flat sheet complying with ASTM B209 (ASTM B209M), alloy and temper recommended by aluminum producer and finisher for type of use and finish indicated, and with strength and durability properties of not less than Alloy 5005-H32.
 - a. Aluminum Sheet: 0.063 inch (1.60 mm).
 - i Finish: Baked enamel or powder coat
3. Type 316 stainless steel is more corrosion resistant and more expensive than Type 304.
4. Galvanized-Steel Sheet: ASTM A240/A240M or ASTM A666, Type 304 Type 316, stretcher-leveled standard of flatness.
5. Form closures and trim from metal of type and thickness indicated below. Fabricate to fit tightly to adjoining construction. Retain one of three subparagraphs below or revise to specify another metal or thickness.
 - a. Galvanized-Steel Sheet: 0.052 inch (1.32 mm).
 - i Finish: Baked enamel

B.4 MISCELLANEOUS MATERIALS

1. Miscellaneous Metal Subframing and Furring: ASTM C645, cold-formed, metallic-coated steel sheet, ASTM A653/A653M, G90 (Z275 hot-dip galvanized) coating designation or ASTM A792/A792M, Class AZ50 (Class AZM150) aluminum-zinc-alloy coating designation unless otherwise indicated. Provide manufacturer's standard sections as required for support and alignment of metal panel system.

2. Panel Accessories: Provide components required for a complete, weathertight panel system including trim, copings, fasciae, mullions, sills, corner units, clips, flashings, sealants, gaskets, fillers, closure strips, and similar items. Match material and finish of metal panels unless otherwise indicated.
 - a. Closures: Provide closures at eaves and rakes, fabricated of same metal as metal panels.
 - b. Backing Plates: Provide metal backing plates at panel end splices, fabricated from material recommended by manufacturer.
 - c. Closure Strips: Closed-cell, expanded, cellular, rubber or crosslinked, polyolefin-foam or closed-cell laminated polyethylene; minimum 1-inch- (25-mm-) thick, flexible closure strips; cut or pre-molded to match metal panel profile. Provide closure strips where indicated or necessary to ensure weathertight construction.
 - i Backer Board: Hardboard complying with ANSI A135.4, Class 1 tempered, 1/8 inch (3 mm) 1/4 inch (6 mm) thick unless otherwise indicated.
 - ii Flashing and Trim: Provide flashing and trim formed from same material as metal panels as required to seal against weather and to provide finished appearance. Locations include, but are not limited to, bases, drips, sills, jambs, corners, endwalls, framed openings, rakes, fasciae, parapet caps, soffits, reveals, and fillers. Finish flashing and trim with same finish system as adjacent metal panels.
 - iii Panel Fasteners: Self-tapping screws designed to withstand design loads. Provide exposed fasteners with heads matching color of metal panels by means of plastic caps or factory-applied coating. Provide EPDM or PVC sealing washers for exposed fasteners.
 - iv Panel Sealants: Provide sealant type recommended by manufacturer that are compatible with panel materials, are nonstaining, and do not damage panel finish.
 - 1) Sealant Tape: Pressure-sensitive, 100 percent solids, gray polyisobutylene compound sealant tape with release-paper backing. Provide permanently elastic, nonsag, nontoxic, nonstaining tape 1/2 inch (13 mm) wide and 1/8 inch (3 mm) thick.
 - 2) Joint Sealant: ASTM C920; elastomeric polyurethane or silicone sealant; of type, grade, class, and use classifications required to seal joints in metal panels and remain weathertight; and as recommended in writing by metal panel manufacturer.
 - 3) Butyl-Rubber-Based, Solvent-Release Sealant: ASTM C1311.
 - d. Anchors: Provide fastener systems with an evaluation report acceptable to authorities having jurisdiction, based on ICC-ES AC193 or ICC-ES AC308.
 - e. Anchor Materials:
 - i Material in "Material for Interior Locations" Subparagraph below protects against corrosion in an indoor atmosphere. Material for Interior Locations: Carbon-steel components zinc plated to comply with ASTM B633 or ASTM F1941 (ASTM F1941M), Class Fe/Zn 5, unless otherwise indicated.
 - ii Alloy Group 1 (A1) refers to Type 304 and similar alloys, and Alloy Group 2 (A4) refers to Type 316 and similar alloys. Material for Exterior Locations and Where Stainless Steel Is Indicated: Alloy Group 1 (A1) Group 2 (A4) stainless-steel bolts, ASTM F593 (ASTM F738M), and nuts, ASTM F594 (ASTM F836M).

B.5 FABRICATION

- a. General: Fabricate and finish metal panels and accessories at the factory, by manufacturer's standard procedures and processes, as necessary to fulfill indicated performance requirements demonstrated by laboratory testing. Comply with indicated profiles and with dimensional and structural requirements.

- b. Provide panel profile, including major ribs and intermediate stiffening ribs, if any, for full length of panel.
- c. Fabricate metal panel joints with factory-installed captive gaskets or separator strips that provide a weathertight seal and prevent metal-to-metal contact, and that minimize noise from movements.
- d. Honeycomb-Core Metal Wall Panels: Fabricate panels using manufacturer's standard thermosetting structural adhesive in a lamination process that bonds panel under minimum 10-psi (69-kPa) pressure. Use of contact adhesives with pinch-roll process is unacceptable.
 - 1) Panel Bow Tolerance: Not more than 0.5 percent of panel width or length.
- e. Sheet Metal Flashing and Trim: Fabricate flashing and trim to comply with manufacturer's recommendations and recommendations in SMACNA's "Architectural Sheet Metal Manual" that apply to design, dimensions, metal, and other characteristics of item indicated.
 - i Form exposed sheet metal accessories that are without excessive oil canning, buckling, and tool marks and that are true to line and levels indicated, with exposed edges folded back to form hems.
 - ii Seams for Aluminum: Fabricate nonmoving seams with flat-lock seams. Form seams and seal with epoxy seam sealer. Rivet joints for additional strength.
 - iii Seams for Other Than Aluminum: Fabricate nonmoving seams in accessories with flat-lock seams. Tin edges to be seamed, form seams, and solder.
 - iv Sealed Joints: Form nonexpansion, but movable, joints in metal to accommodate sealant and to comply with SMACNA standards.
 - v Conceal fasteners and expansion provisions where possible. Exposed fasteners are not allowed on faces of accessories exposed to view.
 - vi Fabricate cleats and attachment devices from same material as accessory being anchored or from compatible, noncorrosive metal recommended in writing by metal panel manufacturer.
 - 1) Size: As recommended by SMACNA's "Architectural Sheet Metal Manual" or metal wall panel manufacturer for application but not less than thickness of metal being secured.

B.6 FINISHES

1. Protect mechanical and painted finishes on exposed surfaces from damage by applying a strippable, temporary protective covering before shipping.
2. Appearance of Finished Work: Variations in appearance of abutting or adjacent pieces are acceptable if they are within one-half of the range of approved Samples. Noticeable variations in same piece are not acceptable. Variations in appearance of other components are acceptable if they are within the range of approved Samples and are assembled or installed to minimize contrast.
3. Interior Steel Panels and Accessories:
 - a. Finish: Baked enamel
4. Aluminum Exterior Panels and Accessories (if color is specified):
 - a. Three-Coat Fluoropolymer: AAMA 2605. Fluoropolymer finish containing not less than 70 percent PVDF resin by weight in both color coat and clear topcoat. Prepare, pretreat, and apply coating to exposed metal surfaces to comply with coating and resin manufacturers' written instructions.
 - b. Exposed Anodized Finish:
 - i Color Anodic Finish: AAMA 611, AA-M12C22A42/A44, Class I, 0.018 mm AA-M12C22A32/A34, Class II, 0.010 mm or thicker.

C Construction

C.1 EXAMINATION

1. Examine substrates, areas, and conditions, with Installer present, for compliance with requirements for installation tolerances, metal panel supports, and other conditions affecting performance of the Work.
 - a. Examine wall framing to verify that girts, angles, channels, studs, and other structural panel support members and anchorage have been installed within alignment tolerances required by metal wall panel manufacturer.
 - b. Examine wall sheathing to verify that sheathing joints are supported by framing or blocking and that installation is within flatness tolerances required by metal wall panel manufacturer.
 - i. Verify that air- or water-resistive barriers have been installed over sheathing or backing substrate to prevent air infiltration or water penetration.
2. Examine roughing-in for components and systems penetrating metal panels to verify actual locations of penetrations relative to seam locations of metal panels before installation.
3. Proceed with installation only after unsatisfactory conditions have been corrected.

C.2 PREPARATION

1. Miscellaneous Supports: Install subframing, furring, and other miscellaneous panel support members and anchorages according to ASTM C754 and metal panel manufacturer's written recommendations.

C.3 INTERIOR METAL PANEL INSTALLATION

1. General: Install metal panels according to manufacturer's written instructions in orientation, sizes, and locations indicated. Install panels perpendicular to supports unless otherwise indicated. Anchor metal panels and other components of the Work securely in place, with provisions for thermal and structural movement.
 - a. Shim or otherwise plumb substrates receiving metal panels.
 - b. Flash and seal metal panels at perimeter of all openings. Fasten with self-tapping screws. Do not begin installation until air- or water-resistive barriers and flashings that will be concealed by metal panels are installed.
 - c. Install screw fasteners in predrilled holes.
 - d. Locate and space fastenings in uniform vertical and horizontal alignment.
 - e. Install flashing and trim as metal panel work proceeds.
 - f. Locate panel splices over, but not attached to, structural supports. Stagger panel splices and end laps to avoid a four-panel lap splice condition.
 - g. Align bottoms of metal panels and fasten with blind rivets, bolts, or self-tapping screws. Fasten flashings and trim around openings and similar elements with self-tapping screws.
 - h. Provide weathertight escutcheons for pipe- and conduit-penetrating panels.
2. Fasteners:
 - a. Steel Panels: Use stainless-steel fasteners for surfaces exposed to the exterior; use galvanized-steel fasteners for surfaces exposed to the interior.
 - b. Aluminum Panels: Use aluminum or stainless-steel fasteners for surfaces exposed to the exterior; use aluminum or galvanized-steel fasteners for surfaces exposed to the interior.
3. Metal Protection: Where dissimilar metals contact each other or corrosive substrates, protect against galvanic action as recommended in writing by metal panel manufacturer.

4. Joint Sealers: Install gaskets, joint fillers, and sealants where indicated and where required for weathertight performance of metal wall panel assemblies. Provide types of gaskets, fillers, and sealants indicated by metal panel manufacturer; or, if not indicated, provide types recommended by metal wall panel manufacturer.
 - a. Seal metal wall panel end laps with double beads of tape or sealant, full width of panel. Seal side joints where recommended by metal wall panel manufacturer.
 - b. Prepare joints and apply sealants to comply with requirements in Section "Joint Sealants."

C.4 INSULATED METAL WALL PANEL INSTALLATION

1. General: Apply continuous ribbon of sealant to panel joint on concealed side of insulated metal wall panels as vapor seal; apply sealant to panel joint on exposed side of panels for weather seal.
 - a. Fasten foamed-insulation-core metal wall panels to supports with fasteners at each lapped joint at location and spacing and with fasteners recommended by manufacturer.
 - b. Apply panels and associated items true to line for neat and weathertight enclosure. Avoid "panel creep" or application not true to line.
 - c. Provide metal-backed washers under heads of exposed fasteners on weather side of insulated metal wall panels.
 - d. Locate and space exposed fasteners in uniform vertical and horizontal alignment. Use proper tools to obtain controlled uniform compression for positive seal without rupture of washer.
 - e. Provide sealant tape at lapped joints of insulated metal wall panels and between panels and protruding equipment, vents, and accessories.
 - f. Apply a continuous ribbon of sealant tape to panel side laps and elsewhere as needed to make panels weathertight.
 - g. Apply snap-on battens to exposed-fastener, insulated-core metal wall panel seams to conceal fasteners.
2. Foamed-Insulation-Core Metal Wall Panels: Fasten metal wall panels to supports with concealed clips at each joint at location and spacing and with fasteners recommended by manufacturer. Fully engage tongue and groove of adjacent panels.
 - a. Install clips to supports with self-tapping fasteners.
3. Laminated-Insulation-Core Metal Wall Panels:
 - a. Wrapped-Edge Panels: Mechanically attach wall panels to supports using staggered, concealed side clips engaging wrapped panel edges. Install clips to supports with self-tapping fasteners. Seal joints with backer rod and sealant manufacturer's standard gaskets.
 - b. Wrapped-Edge Panels: Mechanically attach wall panels through extended edge of panels to supports using self-tapping fasteners. Seal joints with backer rod and sealant manufacturer's standard gaskets.
 - c. Shiplap-Edge Panels: Mechanically attach wall panels to supports using staggered, concealed side clips engaging tongue-and-groove panel edges. Install clips to supports with self-tapping fasteners.
 - i. Vertical Joints: Maintain reveal joint of consistent width Seal joints with backer rod and sealant Seal joints with manufacturer's standard gaskets.
 - d. Framed-Edge Panels: Mechanically attach wall panels through integral, extruded edge members to supports using self-tapping fasteners. Seal joints with manufacturer's standard gaskets.

C.5 FIELD QUALITY CONTROL

1. Testing Agency: Engage a qualified testing agency to perform tests and inspections.
2. Water-Spray Test: After installation, test area of assembly shown on Drawings as directed by Architect for water penetration according to AAMA 501.2.

3. Manufacturer's Field Service: Engage a factory-authorized service representative to test and inspect completed metal wall panel installation, including accessories.
4. Metal wall panels will be considered defective if they do not pass test and inspections.
5. Additional tests and inspections, at contractor's expense, are performed to determine compliance of replaced or additional work with specified requirements.
6. Prepare test and inspection reports.

C.6 CLEANING AND PROTECTION

1. Remove temporary protective coverings and strippable films, if any, as metal panels are installed, unless otherwise indicated in manufacturer's written installation instructions. On completion of metal panel installation, clean finished surfaces as recommended by metal panel manufacturer. Maintain in a clean condition during construction.
2. After metal panel installation, clear weep holes and drainage channels of obstructions, dirt, and sealant.
3. Replace metal panels that have been damaged or have deteriorated beyond successful repair by finish touchup or similar minor repair procedures.

D Measurement

The department will measure Exterior Metal Panels by the square foot, acceptably completed. The quantity to be paid for will be the sum of the areas of exposed faces at the locations shown on the plans. Area will be determined from measurements taken in the plane of the exposed face of the panels.

E Payment

The department will pay for measured quantities at the contract unit price under the following bid item:

ITEM NUMBER	DESCRIPTION	UNIT
SPV.0165.05	Exterior Metal Panels	SF

Payment is full compensation for design, shop drawings, samples, mockups, testing, fabrication, and installation.

69. Louvers, Item SPV.0165.06

A Description

A.1 SUMMARY

1. Section Includes:
 - a. Fixed extruded-aluminum louvers.
 - b. Blank-off panels for louvers

A.2 DEFINITIONS

1. Louver Terminology: Definitions of terms for metal louvers contained in AMCA 501 apply to this Section unless otherwise defined in this Section or in referenced standards.
2. Horizontal Louver: Louver with horizontal blades (i.e., the axis of the blades are horizontal).
3. Vertical Louver: Louver with vertical blades (i.e., the axis of the blades are vertical).
4. Drainable-Blade Louver: Louver with blades having gutters that collect water and drain it to channels in jambs and mullions, which carry it to bottom of unit and away from opening.
5. Wind-Driven-Rain-Resistant Louver: Louver that provides specified wind-driven-rain performance, as determined by testing according to AMCA 500-L.
6. Windborne-Debris-Impact-Resistant Louver: Louver that provides specified windborne-debris-impact resistance, as determined by testing according to AMCA 540.

A.3 ACTION SUBMITTALS

1. Product Data: For each type of product.
 - a. For louvers specified to bear AMCA seal, include printed catalog pages showing specified models with appropriate AMCA Certified Ratings Seals.
2. Sustainable Design Submittals:
3. Shop Drawings: For louvers and accessories. Include plans, elevations, sections, details, and attachments to other work. Show frame profiles and blade profiles, angles, and spacing.
 - a. Show weep paths, gaskets, flashings, sealants, and other means of preventing water intrusion.
 - b. Show mullion profiles and locations.
4. Samples: For each type of metal finish required.
5. Delegated Design Submittal: For louvers indicated to comply with structural and seismic performance requirements and design criteria, including analysis data signed and sealed by the qualified professional engineer responsible for their preparation.

A.4 INFORMATIONAL SUBMITTALS

1. Product Test Reports: Based on evaluation of comprehensive tests performed according to AMCA 500-L by a qualified testing agency or by manufacturer and witnessed by a qualified testing agency, for each type of louver and showing compliance with performance requirements specified.
2. Windborne-debris-impact-resistance test reports.
3. Sample Warranties: For manufacturer's special warranties.

A.5 QUALITY ASSURANCE

1. Welding Qualifications: Qualify procedures and personnel according to the following:
 - a. AWS D1.2/D1.2M, "Structural Welding Code - Aluminum."

A.6 FIELD CONDITIONS

1. Field Measurements: Verify actual dimensions of openings by field measurements before fabrication.

A.7 WARRANTY

1. Special Finish Warranty, Factory-Applied Finishes: Standard form in which manufacturer agrees to repair finishes or replace aluminum that shows evidence of deterioration of baked enamel, powder coat, or organic finishes within specified warranty period.
 - a. Deterioration includes, but is not limited to, the following:
 - i Color fading more than 5 Delta E units when tested according to ASTM D2244.
 - ii Chalking in excess of a No. 8 rating when tested according to ASTM D4214.
 - iii Cracking, checking, peeling, or failure of paint to adhere to bare metal.
 - b. Warranty Period: 10 years from date of Substantial Completion.
2. Special Finish Warranty, Anodized Finishes: Standard form in which manufacturer agrees to repair finishes or replace aluminum that shows evidence of deterioration of anodized finishes within specified warranty period.
 - a. Deterioration includes, but is not limited to, the following:
 - i Color fading more than 5 Delta E units when tested according to ASTM D2244.
 - ii Chalking in excess of a No. 8 rating when tested according to ASTM D4214.
 - iii Cracking, peeling, or chipping.

- b. Warranty Period: 10 years from date of Substantial Completion.

B Materials

B.1 MANUFACTURERS

1. Source Limitations: Obtain fixed and operable louvers from single source from a single manufacturer where indicated to be of same type, design, or factory-applied color finish.

B.2 PERFORMANCE REQUIREMENTS

1. Delegated Design: Design louvers, including comprehensive engineering analysis by a qualified professional engineer, using structural and seismic performance requirements and design criteria indicated.
2. Structural Performance: Louvers withstand the effects of gravity loads and the following loads and stresses within limits and under conditions indicated without permanent deformation of louver components, noise or metal fatigue caused by louver-blade rattle or flutter, or permanent damage to fasteners and anchors. Wind pressures are considered to act normal to the face of the building.
 - a. Wind Loads:
 - i Determine loads based on pressures as indicated on Drawings.
3. Windborne-Debris-Impact Resistance: Louvers located within 30 feet (9.1 m) of grade pass basic enhanced protection, when tested according to AMCA 540.
4. Seismic Performance:
 - a. As indicated on Drawings.
5. Louver Performance Ratings: Provide louvers complying with requirements specified, as demonstrated by testing manufacturer's stock units identical to those provided, except for length and width according to AMCA 500-L.
6. Thermal Movements: Allow for thermal movements from ambient and surface temperature changes.
 - a. Temperature Change (Range): 120 deg F (67 deg C), ambient; 180 deg F (100 deg C), material surfaces.
7. SMACNA Standard: Comply with recommendations in SMACNA's "Architectural Sheet Metal Manual" for fabrication, construction details, and installation procedures.

B.3 FIXED EXTRUDED-ALUMINUM LOUVERS

1. Horizontal Drainable-Blade Louver, Extruded Aluminum.
 - a. Manufacturers:
 - i Architectural Louvers, OH
 - ii CENTRIA or approved equal.
 - iii Louver Depth: 6 inches (100 mm).
 - iv Frame and Blade Nominal Thickness: Not less than 0.080 inch (2.03 mm) 0.060 inch (1.52 mm) for blades and 0.080 inch (2.03 mm) for frames.
 - v Mullion Type: Exposed.
 - vi Louver Performance Ratings:
 - 1) Free Area: Not less than 7.0 sq. ft. (0.65 sq. m) 7.5 sq. ft. (0.70 sq. m) 8.0 sq. ft. (0.74 sq. m) 8.5 sq. ft. (0.79 sq. m) for 48-inch- (1220-mm-) wide by 48-inch- (1220-mm-) high louver.
 - 2) Point of Beginning Water Penetration: Not less than 900 fpm (4.6 m/s) 950 fpm (4.8 m/s) 1000 fpm (5.1 m/s) 1050 fpm (5.3 m/s) 1100 fpm (5.6 m/s).

- 3) Air Performance:
 - Not more than 0.10-inch wg (25-Pa) static pressure drop at 700-fpm (3.6-m/s) 750-fpm (3.8-m/s) 800-fpm (4.1-m/s) 850-fpm (4.3-m/s) free-area exhaust intake velocity.
 - Not more than 0.15-inch wg (37-Pa) static pressure drop at 900-fpm (4.6-m/s) 950-fpm (4.8-m/s) 1000-fpm (5.1-m/s) free-area exhaust intake velocity.
 - vii AMCA Seal: Mark units with AMCA Certified Ratings Seal.
 - viii Horizontal, Continuous-Line, Drainable-Blade Louver, Extruded Aluminum: Drainable-blade louver with blade gutters (drains) in rear two-thirds of blades only.
 - ix Louver Depth: 6 inches (150 mm).
 - x Frame and Blade Nominal Thickness: Not less than 0.080 inch (2.03 mm).
 - xi Mullion Type: Semirecessed.
 - xii Louver Performance Ratings:
 - 1) Free Area: Not less than 7.8 sq. ft. (0.72 sq. m) for 48-inch- (1220-mm-) wide by 48-inch- (1220-mm-) high louver.
 - 2) Point of Beginning Water Penetration: Not less than 850 fpm (4.3 m/s).
 - 3) Air Performance: Not more than 0.10-inch wg (25-Pa) static pressure drop at 800-fpm (4.1-m/s) free-area exhaust intake velocity.
 - xiii AMCA Seal: Mark units with AMCA Certified Ratings Seal.
2. Horizontal, Drainable-Blade, Windborne-Debris-Impact-Resistant Louver, Extruded Aluminum:
 - a. Louver Depth: 4 inches (100 mm) 6 inches (150 mm).
 - b. Frame and Blade Nominal Thickness: Not less than 0.080 inch (2.03 mm).
 - c. Mullion Type: Exposed.
 - d. Louver Performance Ratings:
 - i Free Area: Not less than 8.5 sq. ft. (0.79 sq. m) 9.0 sq. ft. (0.84 sq. m) for 48-inch- (1220-mm-) wide by 48-inch- (1220-mm-) high louver.
 - ii Point of Beginning Water Penetration: Not less than 1077 fpm (5.5 m/s) 1100 fpm (5.6 m/s).
 - iii Air Performance:
 - 1) Not more than 0.16-inch wg (40-Pa) static pressure drop at 989-fpm (5.0-m/s) free-area exhaust intake velocity.
 - 2) Not more than 0.15-inch wg (37-Pa) static pressure drop at 1077-fpm (5.5-m/s) free-area exhaust intake velocity.
 - e. AMCA Seal: Mark units with AMCA Certified Ratings Seal.
 - f. AMCA Rating: AMCA 540.

B.4 BLANK-OFF PANELS

1. Insulated Blank-Off Panels: Laminated panels consisting of an insulating core surfaced on back and front with metal sheets and attached to back of louver.
 - a. Thickness: 2 inches (50 mm).
 - b. Metal Facing Sheets, Aluminum: Not less than 0.032-inch (0.81-mm) nominal thickness.
 - c. Insulating Core: Rigid, glass-fiber-board insulation or extruded-polystyrene foam.

- d. Edge Treatment: Trim perimeter edges of blank-off panels with louver manufacturer's standard extruded-aluminum-channel frames, not less than 0.080-inch (2.03-mm) nominal thickness channel frames, with corners mitered and with same finish as panels.
- e. Seal perimeter joints between panel faces and louver frames with gaskets or sealant.
- f. Panel Finish: Same finish applied to louvers Same type of finish applied to louvers, but black color.
- g. Attach blank-off panels with clips sheet metal screws.

B.5 MATERIALS

1. Aluminum Extrusions: ASTM B221 (ASTM B221M), Alloy 6063-T5, T-52, or T6.
2. Aluminum Sheet: ASTM B209 (ASTM B209M), Alloy 3003 or 5005, with temper as required for forming, or as otherwise recommended by metal producer for required finish.
3. Fasteners: Use types and sizes to suit unit installation conditions.
 - a. Use Phillips flat-head hex-head or Phillips pan-head tamper-resistant screws for exposed fasteners unless otherwise indicated.
 - b. For fastening aluminum, use aluminum or 300 series stainless steel fasteners.
 - c. For fastening galvanized steel, use hot-dip-galvanized-steel or 300 series stainless steel fasteners.
 - d. For fastening stainless steel, use 300 series stainless steel fasteners.
 - e. For color-finished louvers, use fasteners with heads that match color of louvers.
4. Bituminous Paint: Cold-applied asphalt emulsion complying with ASTM D1187/D1187M.

B.6 FABRICATION

1. Factory assemble louvers to minimize field splicing and assembly. Disassemble units as necessary for shipping and handling limitations. Clearly mark units for reassembly and coordinated installation.
2. Vertical Assemblies: Where height of louver units exceeds fabrication and handling limitations, fabricate units to permit field-bolted assembly with close-fitting joints in jambs and mullions, reinforced with splice plates.
 - a. Continuous Vertical Assemblies: Fabricate units without interrupting blade-spacing pattern unless horizontal mullions are indicated where indicated.
 - b. Horizontal Mullions: Provide horizontal mullions at joints unless continuous vertical assemblies are indicated where indicated.
3. Maintain equal louver blade spacing, including separation between blades and frames at head and sill, to produce uniform appearance.
4. Fabricate frames, including integral sills, to fit in openings of sizes indicated, with allowances made for fabrication and installation tolerances, adjoining material tolerances, and perimeter sealant joints.
 - a. Frame Type: Channel unless otherwise indicated.
5. Include supports, anchorages, and accessories required for complete assembly.
6. Provide vertical mullions of type and at spacings indicated, but not more than is recommended by manufacturer, or 72 inches (1830 mm) o.c., whichever is less.
 - a. Exposed Mullions: Where indicated, provide units with exposed mullions of same width and depth as louver frame. Where length of louver exceeds fabrication and handling limitations, provide interlocking split mullions designed to permit expansion and contraction.

- b. Exterior Corners: Prefabricated corner units with mitered and welded blades blades with concealed close-fitting splices and with fully recessed semi-recessed mullions at corners.
7. Provide subsills made of same material as louvers or extended sills for recessed louvers.
8. Join frame members to each other and to fixed louver blades with fillet welds concealed from view, threaded fasteners, or both, as standard with louver manufacturer unless otherwise indicated or size of louver assembly makes bolted connections between frame members necessary.

B.7 ALUMINUM FINISHES

1. Finish louvers after assembly.
2. Color Anodic Finish: AAMA 611, AA-M12C22A42/A44, Class I, 0.018 mm AA-M12C22A32/A34, Class II, 0.010 mm or thicker.
 - a. Color: As selected by Architect from full range of industry colors and color densities
3. Conversion-Coated Finish: AA-C12C42, nonetched, cleaned with inhibited chemicals, and chemical conversion coated with acid chromate-fluoride-phosphate.
4. Factory-Primed Finish: AA-C12C42R1x with air-dried primer of not less than 2-mil (0.05-mm) dry film thickness.
5. Baked-Enamel or Powder-Coat Finish: AAMA 2603. Comply with coating manufacturer's written instructions for cleaning, conversion coating, and applying and baking finish.
 - a. Color and Gloss: As indicated by manufacturer's designations Match Architect's sample as selected by Architect from manufacturer's full range .
6. High-Performance Organic Finish, Two-Coat PVDF: Fluoropolymer finish complying with AAMA 2604 AAMA 2605 and containing not less than 50 70 percent PVDF resin by weight in color coat.
 - a. Prepare, pretreat, and apply coating to exposed metal surfaces to comply with coating and resin manufacturers' written instructions for seacoast and severe environments.
 - b. Color and Gloss: As indicated by manufacturer's designations Match Architect's sample as selected by Architect from manufacturer's full range.

C Construction

C.1 EXAMINATION

1. Examine substrates and openings, with Installer present, for compliance with requirements for installation tolerances and other conditions affecting performance of the Work.
2. Proceed with installation only after unsatisfactory conditions have been corrected.

C.2 PREPARATION

1. Coordinate setting drawings, diagrams, templates, instructions, and directions for installation of anchorages that are to be embedded in concrete or masonry construction. Coordinate delivery of such items to Project site.

C.3 INSTALLATION

1. Locate and place louvers level, plumb, and at indicated alignment with adjacent work.
2. Use concealed anchorages where possible. Provide brass or lead washers fitted to screws where required to protect metal surfaces and to make a weathertight connection.
3. Form closely fitted joints with exposed connections accurately located and secured.
4. Provide perimeter reveals and openings of uniform width for sealants and joint fillers, as indicated.

5. Protect unpainted galvanized- and nonferrous-metal surfaces that are in contact with concrete, masonry, or dissimilar metals from corrosion and galvanic action by applying a heavy coating of bituminous paint or by separating surfaces with waterproof gaskets or nonmetallic flashing.
6. Install concealed gaskets, flashings, joint fillers, and insulation as louver installation progresses, where weathertight louver joints are required. Comply with Section "Joint Sealants" for sealants applied during louver installation.

C.4 ADJUSTING AND CLEANING

1. Clean exposed louver surfaces that are not protected by temporary covering, to remove fingerprints and soil during construction period. Do not let soil accumulate during construction period.
2. Before final inspection, clean exposed surfaces with water and a mild soap or detergent not harmful to finishes. Thoroughly rinse surfaces and dry.
3. Restore louvers damaged during installation and construction, so no evidence remains of corrective work. If results of restoration are unsuccessful, as determined by Architect, remove damaged units and replace with new units.
 - a. Touch up minor abrasions in finishes with air-dried coating that matches color and gloss of, and is compatible with, factory-applied finish coating.

D Measurement

The department will measure Louvers by the square foot, acceptably completed. The quantity to be paid for will be the sum of the areas of exposed faces at the locations shown on the plans. Area will be determined from measurements taken in the plane of the exposed face of the louvers.

E Payment

The department will pay for measured quantities at the contract unit price under the following bid item:

ITEM NUMBER	DESCRIPTION	UNIT
SPV.0165.06	Louvers	SF

Payment is full compensation for furnishing and installation of all exterior louvers in the project.

70. Finishes, Item SPV.0165.07

A Description

A.1 Section Includes:

1. Pressed floor tile – Janitor closet.
2. Glazed wall tile -Janitor closet.
3. Thresholds.
4. Tile backing panels.
5. Waterproof membranes.
6. Crack isolation membranes.
7. Epoxy based floor coating -all interior spaces outside tile including stairs
8. Interior Painting

A.2 Description for Ceramic Tiling

Related Requirements:

- "Cold Fluid-Applied Waterproofing" for waterproofing under thickset mortar beds.

1. DEFINITIONS

- a. General: Definitions in the ANSI A108 series of tile installation standards and in ANSI A137.1 apply to Work of this Section unless otherwise specified.
- b. Face Size: Actual tile size, excluding spacer lugs.
- c. Module Size: Actual tile size plus joint width indicated.

2. PREINSTALLATION MEETINGS

- a. Preinstallation Conference: Conduct conference at Project site
 - i Review requirements in ANSI A108.01 for substrates and for preparation by other trades.

3. ACTION SUBMITTALS

- a. Product Data: For each type of product: (1) floor tile (2) wall tile.
- b. Sustainable Design Submittals:
- c. Shop Drawings: Show locations of each type of tile and tile pattern. Show widths, details, and locations of expansion, contraction, control, and isolation joints in tile substrates and finished tile surfaces.
- d. Samples for Initial Selection: For tile, grout, and accessories involving color selection.
- e. Samples for Verification:
 - i Full-size units of each type and composition of tile and for each color and finish required. For ceramic mosaic tile in color blend patterns, provide full sheets of each color blend.
 - ii Assembled samples mounted on a rigid panel, with grouted joints, for each type and composition of tile and for each color and finish required. Make samples at least 12 inches square 36 inches square, but not fewer than four tiles. Use grout of type and in color or colors approved for completed Work.
 - iii Full-size units of each type of trim and accessory for each color and finish required.
 - iv Stone thresholds in 6-inch lengths.
 - v Metal edge strips in 6-inch lengths.

4. INFORMATIONAL SUBMITTALS

- a. Qualification Data: For Installer.
- b. Master Grade Certificates: For each shipment, type, and composition of tile, signed by tile manufacturer and Installer.
- c. Product Certificates: For each type of product.
- d. Product Test Reports: For tile-setting and -grouting products and certified porcelain tile.

5. MAINTENANCE MATERIAL SUBMITTALS

- a. Furnish extra materials that match and are from same production runs as products installed and that are packaged with protective covering for storage and identified with labels describing contents.
 - i Tile and Trim Units: Furnish quantity of full-size units equal to 3 percent of amount installed for each type, composition, color, pattern, and size indicated.
 - ii Grout: Furnish quantity of grout equal to 3 percent of amount installed for each type, composition, and color indicated.

6. QUALITY ASSURANCE

a. Installer Qualifications:

- i Installer is a Five-Star member of the National Tile Contractors Association or a Trowel of Excellence member of the Tile Contractors' Association of America.
- ii Installer's supervisor for Project holds the International Masonry Institute's Foreman Certification.
- iii Installer employs only Ceramic Tile Education Foundation Certified Installers or installers recognized by the U.S. Department of Labor as Journeyman Tile Layers for Project.
- iv Installer employs at least one installer for Project that has completed the Advanced Certification for Tile Installers (ACT) certification for installation of mud floors mud walls membranes gauged porcelain tile/gauged porcelain tile panels and slabs and large format tile.

b. Mockups: Build mockups to verify selections made under Sample submittals and to demonstrate aesthetic effects and set quality standards for materials and execution.

- i Build mockup of each type of floor tile installation.
- ii Build mockup of each type of wall tile installation.
- iii Subject to compliance with requirements, approved mockups may become part of the completed Work if undisturbed at time of Substantial Completion.

7. DELIVERY, STORAGE, AND HANDLING

- a. Deliver and store packaged materials in original containers with seals unbroken and labels intact until time of use. Comply with requirements in ANSI A137.1 for labeling tile packages.
- b. Store tile and cementitious materials on elevated platforms, under cover, and in a dry location.
- c. Store aggregates where grading and other required characteristics can be maintained, and contamination can be avoided.
- d. Store liquid materials in unopened containers and protected from freezing.

8. FIELD CONDITIONS

- a. Environmental Limitations: Do not install tile until construction in spaces is complete and ambient temperature and humidity conditions are maintained at the levels indicated in referenced standards and manufacturer's written instructions.

A.3 Description for Floor Epoxy Coating (Resinous flooring)

A.3.1 Provide all epoxy coating work as indicated on the Drawings and as specified herein.

1. REFERENCES

- a. References and industry standards listed in this Section are applicable to the Work. Unless more restrictive criteria or differing requirements are explicitly stated in the Specifications, or mandated by governing codes or regulations, the recommendations, suggestions, and requirements described in the referenced standards shall be deemed mandatory and applicable to the Work.
 - i ASTM International (ASTM)
 - C307 Standard Test Method for Tensile Strength of Chemical-Resistant Mortar, Grouts, and Monolithic Surfacing.
 - C413 Standard Test Method for Absorption of Chemical-Resistant Mortars, Grouts, and Monolithic Surfacing and Polymer Concretes
 - C579 Standard Test Methods for Compressive Strength of Chemical-Resistant Mortars, Grouts, Monolithic Surfacing and Polymer Concretes

- C580 Standard Test Method for Flexural Strength and Modulus of Elasticity of Chemical-Resistant Mortars, Grouts, Monolithic Surfacing, and Polymer Concretes
- C811 Standard Practice for Surface Preparation of Concrete for Application of Chemical-Resistant Resin Monolithic Surfacing
- C1028 Standard Test Method for Determining the Static Coefficient of Friction of Ceramic Tile and Other like Surfaces by the Horizontal Dynamometer Pull-Meter Method
- D531 Standard Test Method for Rubber Property-Pusey and Jones Indentation
- D570 Standard Test Method for Water Absorption of Plastics
- D635 Standard Test Method for Rate of Burning and/or Extent and Time of Burning of Plastics in a Horizontal Position
- D638 Standard Test Method for Tensile Properties of Plastics
- D695 Standard Test Method for Compressive Properties of Rigid Plastics
- D696 Standard Test Method for Coefficient of Linear Thermal Expansion of Plastics Between -30°C and 30°C With a Vitreous Silica Dilatometer
- D790 Standard Test Methods for Flexural Properties of Unreinforced and Reinforced Plastics and Electrical Insulating Materials
- D1044 Standard Test Method for Resistance of Transparent Plastics to Surface Abrasion
- D2047 Standard Test Method for Static Coefficient of Friction of Polish-Coated Flooring Surfaces as Measured by the James Machine
- D2240 Standard Test Method for Rubber Property—Durometer Hardness
- E648 Standard Test Method for Critical Radiant Flux of Floor-Covering Systems Using a Radiant Heat Energy Source
- ii National Fire Protection Association (NFPA)
 - NFPA 253 Method of Test for Critical Radiant Flux of Floor Covering Systems Using a Radiant Heat Energy Source.
- iii Military Specifications (MIL)
 - MIL-D-3134
- iv American Concrete Institute (ACI) standards, latest editions
 - ACI 503 Adhesives for concrete
- v Wisconsin Building Code

2. SUBMITTALS

- a. Manufacturer's Data
- b. Printed preparation and application instructions for each type and class of material required.
- c. Manufacturer's certification showing material compliance with specified requirements.
- d. Manufacturer's printed maintenance instructions.
- e. Samples
 - i Samples for Initial Selection: For each type and color of exposed finish required.
 - ii Samples showing range of selected colors and texture variation for approval prior to commencement of work. Samples are to be in a "step-back" format with each layer shown.

- f. Quality Assurance
 - i. Material Test Reports: For each epoxy coating component.
 - ii. Certification that work will be supervised by manufacturer of materials.
 - iii. Core Sampling.
 - iv. Certification of Substrate Acceptability.
 - v. Mockups of floor and base.
- g. Warranty:
- h. Written 2-year Warranty covering materials, signed by Manufacturer.
- i. Low Emitting Materials Compliance Submittals:
 - i. Provide documentation for the epoxy coating to be used indicating that the epoxy coating complies with low V.O.C. requirements as stated in Specification Section G01600.

3. QUALITY ASSURANCE

- a. Certify that the work will be performed with qualified supervision by manufacturer of materials, or by a firm specializing in application of material specified, and acceptable to manufacturer and the Authority.
- b. Core Sampling: At the direction of the Authority and at locations designated by the Authority, take 1 core sample per 1000 sq. ft. (92.9 sq. m) of epoxy coating, or portion of, to verify thickness. For each sample that fails to comply with requirements, take two additional samples. Repair damage caused by coring and correct deficiencies.
- c. Substrate Acceptability
- d. Submit a certified statement issued by the manufacturer of the epoxy coating materials and countersigned by the installer, attesting that all areas and surfaces designated to receive resin matrix flooring have been inspected and found satisfactory for the reception of flooring, and are not in conflict with the manufacturer's requirements. Application of epoxy coating will be construed as acceptance of surfaces.
- e. Mockups: Apply mockups to verify selections made under sample submittals and to demonstrate aesthetic effects and set quality standards for materials and execution.
 - i. Apply full-thickness mockups on 48-inch square floor area selected by Architect.
 - ii. Include 48-inch length of integral cove base.

4. DELIVERY, STORAGE, AND HANDLING

- a. Deliver materials in manufacturer's unopened containers, with trade name, type, grade and other data. Store materials indoors in clean and dry location with temperature between 60° and 90°F.
- b. Damaged containers unsuitable for use will be rejected.

5. JOB CONDITIONS

- a. Follow the epoxy coating manufacturer's recommendations for concrete slab curing materials and methods as well as any other recommendations for concrete slab construction.

6. WARRANTY

- a. Written 2-year Warranty covering materials, signed by Manufacturer. The warranty shall cover, but not be limited to, delamination and wear through.

A.4 Description for Interior Painting

Section includes surface preparation and the application of paint systems on the following interior substrates:

- Cement board
- Concrete.
- Steel and iron (underside of decks and other elements).
- Galvanized metal.
- Gypsum board.

A.4.1 DEFINITIONS

- a. MPI Gloss Level 1: Not more than five units at 60 degrees and 10 units at 85 degrees, according to ASTM D523.
- b. MPI Gloss Level 2: Not more than 10 units at 60 degrees and 10 to 35 units at 85 degrees, according to ASTM D523.
- c. MPI Gloss Level 3: 10 to 25 units at 60 degrees and 10 to 35 units at 85 degrees, according to ASTM D523.
- d. MPI Gloss Level 4: 20 to 35 units at 60 degrees and not less than 35 units at 85 degrees, according to ASTM D523.
- e. MPI Gloss Level 5: 35 to 70 units at 60 degrees, according to ASTM D523.
- f. MPI Gloss Level 6: 70 to 85 units at 60 degrees, according to ASTM D523.
- g. MPI Gloss Level 7: More than 85 units at 60 degrees, according to ASTM D523.

A.4.2 ACTION SUBMITTALS

1. Product Data: For each type of product. Include preparation requirements and application instructions.
 - a. Include printout of current "MPI Approved Products List" for each product category specified, with the proposed product highlighted.
 - b. Indicate VOC content.
2. Sustainable Design Submittals:
3. Samples for Initial Selection: For each type of topcoat product.
4. Samples for Verification: For each type of paint system and in each color and gloss of topcoat.
 - a. Submit Samples on rigid backing, 8 inches square.
 - b. Apply coats on Samples in steps to show each coat required for system.
 - c. Label each coat of each Sample.
 - d. Label each Sample for location and application area.
5. Product List: Use same designations indicated on Drawings and in the Interior Painting Schedule to cross-reference paint systems specified in this Section. Include color designations.

A.4.3 MAINTENANCE MATERIAL SUBMITTALS

1. Furnish extra materials, from the same product run, that match products installed and that are packaged with protective covering for storage and identified with labels describing contents.
 - a. Paint: 5 percent, but not less than 1 gal. of each material and color applied.

A.4.4 QUALITY ASSURANCE

1. Mockups: Apply mockups of each paint system indicated and each color and finish selected to verify preliminary selections made under Sample submittals and to demonstrate aesthetic effects and set quality standards for materials and execution.
 - a. Architect will select one surface to represent surfaces and conditions for application of each paint system.
 - i Vertical and Horizontal Surfaces: Provide samples of at least 100 sq. feet.
 - ii Other Items: Architect will designate items or areas required.
 - b. Final approval of color selections will be based on mockups.
 - c. If preliminary color selections are not approved, apply additional mockups of additional colors selected by Architect at no added cost to Owner.
2. Approval of mockups does not constitute approval of deviations from the Contract Documents contained in mockups unless Architect specifically approves such deviations in writing.
3. Subject to compliance with requirements, approved mockups may become part of the completed Work if undisturbed at time of Substantial Completion.

A.4.5 DELIVERY, STORAGE, AND HANDLING

1. Store materials not in use in tightly covered containers in well-ventilated areas with ambient temperatures continuously maintained at not less than 45 deg F.
 - a. Maintain containers in clean condition, free of foreign materials and residue.
 - b. Remove rags and waste from storage areas daily.

A.4.6 FIELD CONDITIONS

1. Apply paints only when temperature of surfaces to be painted and ambient air temperatures are between 50 and 95 deg F.
2. Do not apply paints when relative humidity exceeds 85 percent; at temperatures of less than 5 deg F above the dew point; or to damp or wet surfaces.

B Materials

B.1 Materials for Tiling

B.1.1 MANUFACTURERS

1. Source Limitations for Tile: Obtain tile of each type and color or finish from single source or producer.
 - a. Obtain tile of each type and color or finish from same production run and of consistent quality in appearance and physical properties for each contiguous area.
2. Source Limitations for Setting and Grouting Materials: Obtain ingredients of a uniform quality for each mortar, adhesive, and grout component from single manufacturer and each aggregate from single source or producer.
 - a. Obtain setting and grouting materials, except for unmodified Portland cement and aggregate, from single manufacturer.
 - b. Obtain waterproof membrane and crack isolation membrane, except for sheet products, from manufacturer of setting and grouting materials.
3. Source Limitations for Other Products: Obtain each of the following products specified in this Section from a single manufacturer:
 - a. Stone thresholds.
 - b. Waterproof membrane.
 - c. Cementitious backer units.

B.1.2 PRODUCTS, GENERAL

1. ANSI Ceramic Tile Standard: Provide tile that complies with ANSI A137.1 for types, compositions, and other characteristics indicated.
 - a. Provide tile complying with Standard grade requirements.
2. ANSI Standards for Tile Installation Materials: Provide materials complying with ANSI A108.02, ANSI standards referenced in other Part 2 articles, ANSI standards referenced by TCNA installation methods specified in tile installation schedules, and other requirements specified.
3. Factory Blending: For tile exhibiting color variations within ranges, blend tile in factory and package so tile units taken from one package show same range in colors as those taken from other packages and match approved Samples.
4. Mounting: For factory-mounted tile, provide back- or edge-mounted tile assemblies as standard with manufacturer unless otherwise indicated.
 - a. Where tile is indicated for installation in wet areas, do not use back- or edge-mounted tile assemblies unless tile manufacturer specifies in writing that this type of mounting is suitable for installation indicated and has a record of successful in-service performance.

B.1.3 TILE PRODUCTS

1. Pressed Floor Tile Type Unglazed.

B.1.4 Manufacturers:

1. American Olean, Daltile, Morrazi USA or approved equal. Composition: porcelain
 - a. Face Size: 11-13/16 by 11-13/16 inches Retain "Face Size Variation" Subparagraph below if required for narrow joints. Calibrated tiles are sorted by the manufacturer to reduce face size variation; rectified tiles have their edges ground to minimize face size variation. See the Evaluations.
 - b. Face Size Variation: Calibrated or rectified.
 - c. Thickness: 1/4 inch
 - d. Face: Plain with cushion edges.
 - e. Dynamic Coefficient of Friction: Not less than 0.42.
 - f. Glaze: Mat, clear.
 - g. Tile Color and Pattern: As selected by Architect from manufacturer's full range
 - h. Grout Color: As selected by Architect from manufacturer's full range Verify availability before retaining "Trim Units" Subparagraph below. If trim units do not match adjoining flat tile, copy and re-edit this "Ceramic Tile Type" Paragraph separately for trim units, deleting option below.
 - i. Trim Units: Coordinated with sizes and coursing of adjoining flat tile where applicable and matching characteristics of adjoining flat tile. Provide shapes as follows, selected from manufacturer's standard shapes:
 - i Base Cove: Cove, module size same as adjoining flat tile.
 - ii Base Cap for Portland Cement Mortar Installations: Bead (bullnose), module size same as adjoining flat tile
 - iii External Corners for Portland Cement Mortar Installations: Bead (bullnose), module size same as adjoining flat tile

- iv Internal Corners:
 - 1) Cove, module size same as adjoining flat tile.
 - 2) Field-buttet square corners. For coved base and cap, use angle pieces designed to fit with stretcher shapes.
 - v Tapered Transition Tile: Shape designed to effect transition between thickness of tile floor and adjoining floor finishes of different thickness, tapered to provide reduction in thickness from 1/2 to 1/4 inch across nominal 4-inch dimension.
3. Porcelain Wall Tile Type: Glazed.

B.1.5 Manufacturers: American Olean, Daltile, Morrazi USA Certification: Tile certified by the Porcelain Tile Certification Agency.

1. Face Size: 11-13/16 by 5-13/16 inches
2. Face Size Variation: Rectified.
3. Thickness: 1/4 inch 3/8 inch
4. Face: Plain with cushion edges.
5. Dynamic Coefficient of Friction: Not less than 0.42.
6. Tile Color, Glaze, and Pattern: As selected by Architect from manufacturer's full range.
7. Grout Color: As indicated by manufacturer's designations Match Architect's sample as selected by Architect from manufacturer's full range.
8. Trim Units: Coordinated with sizes and coursing of adjoining flat tile where applicable and matching characteristics of adjoining flat tile. Provide shapes as follows, selected from manufacturer's standard shapes:
 - a. Base Cap: Surface bullnose, module size same as adjoining flat tile.
 - b. Wainscot Cap: Surface bullnose, module size same as adjoining flat tile
 - c. Wainscot Cap for Flush Conditions: Regular flat tile for conditions where tile wainscot is shown flush with wall surface above it, same size as adjoining flat tile.
 - d. External Corners: Surface bullnose, module size same as adjoining flat tile.
 - e. Internal Corners: Field-buttet square corners.
 - f. Tapered Transition Tile: Shape designed to effect transition between thickness of tile floor and adjoining floor finishes of different thickness, tapered to provide reduction in thickness from 1/2 to 1/4 inch across nominal 4-inch dimension.

B.1.8 THRESHOLDS

1. General: Fabricate to sizes and profiles indicated or required to provide transition between adjacent floor finishes.
 - a. Bevel edges at 1:2 slope, with lower edge of bevel aligned with or up to 1/16 inch above adjacent floor surface. Finish bevel to match top surface of threshold. Limit height of threshold to 1/2 inch or less above adjacent floor surface.
2. Marble Thresholds (janitor closet only): ASTM C503/C503M, with a minimum abrasion resistance of 10 12 according to ASTM C1353 or ASTM C241/C241M and with honed finish.
 - a. Description:
 - i Uniform, fine- to medium-grained white stone with gray veining.

B.1.9 TILE BACKING PANELS

1. Cementitious Backer Units: ANSI A118.9 or ASTM C1325, Type A, in maximum lengths available to minimize end-to-end butt joints.
 - a. Georgia Pacific or approved equal
 - b. Thickness: 5/8 inch
2. Fiber-Cement Backer Board: ASTM C1288, in maximum lengths available to minimize end-to-end butt joints.
 - a. Manufacturers: James Hardie, Durock or approved equal.
 - b. Thickness: 1/4 inch 1/2 inch As indicated.

B.1.10 WATERPROOF MEMBRANES

1. General: Manufacturer's standard product, selected from the following, that complies with ANSI A118.10 and is recommended by the manufacturer for the application indicated. Include reinforcement and accessories recommended by manufacturer.
2. Waterproof Membrane, Fluid-Applied: Liquid-latex rubber or elastomeric polymer.
 - a. Manufacturers: Henry, Sika or approved equal.

B.1.11 CRACK ISOLATION MEMBRANES

1. General: Manufacturer's standard product, selected from the following, that complies with ANSI A118.12 for standard performance high performance and is recommended by the manufacturer for the application indicated. Include reinforcement and accessories recommended by manufacturer.
2. Crack Isolation Membrane, Fabric-Reinforced, Fluid-Applied: System consisting of liquid-latex rubber or elastomeric polymer and fabric reinforcement.
 - a. Manufacturers: Mapei or Approved equal.
3. Portland Cement Mortar (Thickset) Installation Materials: ANSI A108.02.
 - a. Cleavage Membrane: Asphalt felt, ASTM D226/D226M, Type I (No. 15); or polyethylene sheeting, ASTM D4397, 4.0 mils thick.
 - b. Reinforcing Wire Fabric: Galvanized, welded-wire fabric, 2 by 2 inches by 0.062-inch diameter; comply with ASTM A185/A185M and ASTM A82/A82M, except for minimum wire size.
 - c. Expanded Metal Lath: Diamond-mesh lath complying with ASTM C847.
 - i Base Metal and Finish for Interior Applications: Uncoated or zinc-coated (galvanized) steel sheet, with uncoated steel sheet painted after fabrication into lath.
 - ii Base Metal and Finish for Exterior Applications: Zinc-coated (galvanized) steel sheet.
 - iii Configuration over Studs and Furring: Flat.
 - iv Configuration over Solid Surfaces: Self-furring.
 - v Weight: 2.5 lb/sq. yd. 3.4 lb/sq. yard.
 - d. Latex Additive: Manufacturer's standard acrylic resin or styrene-butadiene-rubber water emulsion, serving as replacement for part or all of gaging water, of type specifically recommended by latex-additive manufacturer for use with field-mixed portland cement and aggregate mortar bed.

B.1.12 GROUT MATERIALS

1. Sand-Portland Cement Grout: ANSI A108.10, consisting of white or gray cement and white or colored aggregate as required to produce color indicated.
2. Standard Cement Grout: ANSI A118.6.

B.1.13 MISCELLANEOUS MATERIALS

1. Trowelable Underlayments and Patching Compounds: Latex-modified, portland cement-based formulation provided or approved by manufacturer of tile-setting materials for installations indicated.
2. Metal Edge Strips: Angle or L-shaped, height to match tile and setting-bed thickness, metallic or combination of metal and PVC or neoprene base, designed specifically for flooring applications; half-hard brass white zinc alloy nickel silver stainless steel, ASTM A276/A276M or ASTM A666, 300 Series exposed-edge material.
3. Tile Cleaner: A neutral cleaner capable of removing soil and residue without harming tile and grout surfaces, specifically approved for materials and installations indicated by tile and grout manufacturers.
4. Floor Sealer: Manufacturer's standard product for sealing grout joints and that does not change color or appearance of grout.

B.1.14 MIXING MORTARS AND GROUT

1. Mix mortars and grouts to comply with referenced standards and mortar and grout manufacturers' written instructions.
2. Add materials, water, and additives in accurate proportions.
3. Obtain and use type of mixing equipment, mixer speeds, mixing containers, mixing time, and other procedures to produce mortars and grouts of uniform quality with optimum performance characteristics for installations indicated.

B.2 Materials for Epoxy coating

B.2.1 MANUFACTURERS

1. Available Products: Subject to compliance with requirements, products that may be incorporated into the Work include, but are not limited to, the following:

Sika	Sikadur 22 Lo-Mod
Crossfield (Dex-O-Tex), Roselle Park, NJ	Decor-Floor
Stonhard, Maple Shade, NJ	Stonshield SLT
General Polymers, Cincinnati, OH	Ceramic Carpet 400
BASF Corporation, Shakopee, MN	MasterTop Epoxy Series)
Dur-A-Flex, East Hartford, CT	Dur-A-Quartz
Delta Polymers, North Bayshore, NY	Polycrete MP
Applied Flooring Micor Fluid Manufacturer, Milwaukee, WI	Floorlife DF
PalmaLite, Inc. Bloomfield, NJ	PaliKrom

NOTE: Materials and system described below are as manufactured and applied by PalmaLite, Inc.: PaliKrom epoxy (105 mils) with Palma UV Top Coat for UV Stability. Other acceptable manufacturers shall provide similar systems.

B.2.2 Properties

B.2.2.1 System Characteristics:

1. Color and Pattern: As selected by Architect from manufacturer's full range.
2. Wearing Surface: Manufacturer's standard orange-peel texture.
3. Integral Cove Base: 8 inches (100 mm)
4. Overall System Thickness: 1/8 inch

B.2.2.2 System Materials

1. Epoxy: 100% clear solids, combination 2 parts resin, 1 part hardener.
2. Colored Ceramic Quartz: Angular, translucent, with ceramic coating for color and texture.
3. Silica Sands: 20-40/140 mesh.

B.2.2.3 Mechanical Properties.

Compressive Strength	ASTM C579	11,000 PSI		
ASTM D695		12,000 PSI		
Tensile Strength	ASTM C307	1,600 PSI		
ASTM D638		1,160 PSI		
Flexural Strength	ASTM C580	4,000 PSI	ASTM D790	2,900 PSI
Modules of Elasticity	ASTM C580		1.0x106	lbs./in.2
Water Absorption	ASTM C413	<0.4%		
ASTM D570		<0.3%		
Thermal Coefficient of Expansion	ASTM D696	1.9X105		in./in./°F.
Shore "D" Durometer Hardness	ASTM D2240	Minimum 65		
Taber Abrasion	ASTM D1044	Avg. loss in weight 0.05 gr.		
Taberwear	1000G Load	H-22 Wheel	Abrasive Wear	Index 30
	1000G Load	CS-17 Wheel	Abrasive Wear	Index 590
Resistance to Impact	MIL-D-3134	No chipping, cracking		
Indentation	MIL-D-3134	No cracking		
Bond Strength	ASTM D4541	>400 psi		
	ACI 503	>300 psi		
		substrate	fails	

D. Mechanical properties of cured PalmaLite Palikrom polyurethane finish coat(s):

Taber Index 1000G Load CA-17 Wheel Abrasive Wear Index 22

Tensile Strength Instron Tester
5,000 PSI

Elongation (%) 135	Instron Tester
Impact Resistance Passes 160 in. lbs.	Gardner Labs Impact (Direct)
Flash Point 80oF.	Seta Flash Closed Cup
Coefficient of Friction	0.6 dry ASTM D2047

NOTE: ADA guideline require a coefficient of friction of no less than 0.6

E. Solvent Resistance: Cured PalmaLite PaliKrom with polyurethane finish coat shall resist the following reagents for a period of 7 days.

Inorganic Acids - 10% Hydrochloric, 10% Sulfuric, 35% Sulfuric, 10% Phosphoric, 50% Phosphoric, 2% Chromic, 2% Nitric, Organic Acids - 10% Lactic, 10% Citric, Oleic, Maleis; Alkalis - 10% Sodium Hydroxide; 50% Sodium Hydroxide, Salts - 20% Sodium Chloride, 20% Calcium Chloride, 20% Ferric Chloride, 10% Trisodium Phosphate; Solvents - Gasoline, Hexane, JP-4, Brake Fluid, Xylol, Toluol, Carbon Tetrachloride, Ethylene Glycol, Glycerol, Turpentine; Miscellaneous - Freon, Sour Crude Oil.

F. Cured PalmaLite PaliKrom with polyurethane finish coat shall resist the following reagents against spill and splash minimum 24 hours. Organic Acids - 5% Acetic, 10% Acetic; Alkalis - 10% Ammonium Hydrochloride, 50% Ammonium Hydroxide, Ammonia; Solvents - Trichlorethylene, Methyl Alcohol, Ethyl Alcohol, Acetone, Methyl Ethyl Ketone, Ethyl Acetate; Miscellaneous - Water at 160oF, Urine.

G. UV Stability shall be provided by applying a UV stabile top coat as per manufacturer's recommended product line.

B.3 Materials for Interior Painting

1. MANUFACTURERS:
2. SHERWIN WILLIAMS, BENJAMIN MOORE OR APPROVED EQUAL
3. Products: Subject to compliance with requirements, provide product provide one of the products available products that may be incorporated into the Work include, but are not limited to products listed in the Interior Painting Schedule for the paint category indicated.
4. PAINT, GENERAL
5. MPI Standards: Products shall comply with MPI standards indicated and shall be listed in its "MPI Approved Products List."
6. Material Compatibility:
7. Materials for use within each paint system shall be compatible with one another and substrates indicated, under conditions of service and application as demonstrated by manufacturer, based on testing and field experience.
8. For each coat in a paint system, products shall be recommended in writing by topcoat manufacturers for use in paint system and on substrate indicated.
9. Colors: As selected by Architect from manufacturer's full range.

C Construction

C.1 Construction for Ceramic Tiling

C.1.1 EXAMINATION

1. Examine substrates, areas, and conditions where tile will be installed, with Installer present, for compliance with requirements for installation tolerances and other conditions affecting performance of the Work.
2. Verify that substrates for setting tile are firm; dry; clean; free of coatings that are incompatible with tile-setting materials, including curing compounds and other substances that contain soap, wax, oil, or silicone; and comply with flatness tolerances required by ANSI A108.01 for installations indicated.
3. Verify that concrete substrates for tile floors installed with thinset mortar comply with surface finish requirements in ANSI A108.01 for installations indicated.
4. Verify that surfaces that received a steel trowel finish have been mechanically scarified.
5. Verify that protrusions, bumps, and ridges have been removed by sanding or grinding.
6. Verify that installation of grounds, anchors, recessed frames, electrical and mechanical units of work, and similar items located in or behind tile has been completed.
7. Verify that joints and cracks in tile substrates are coordinated with tile joint locations; if not coordinated, adjust joint locations in consultation with Architect.
8. Proceed with installation only after unsatisfactory conditions have been corrected.

9. PREPARATION

10. Fill cracks, holes, and depressions in concrete substrates for tile floors installed with thinset mortar with trowelable leveling and patching compound specifically recommended by tile-setting material manufacturer.
11. Where indicated, prepare substrates to receive waterproof membrane by applying a reinforced mortar bed that complies with ANSI A108.1A and is sloped 1/4 inch per foot toward drains.
12. Blending: For tile exhibiting color variations, verify that tile has been factory blended and packaged so tile units taken from one package show same range of colors as those taken from other packages and match approved Samples. If not factory blended, either return to manufacturer or blend tiles at Project site before installing.

C.1.2 INSTALLATION OF CERAMIC TILE

1. Comply with TCNA's "Handbook for Ceramic, Glass, and Stone Tile Installation" for TCNA installation methods specified in tile installation schedules. Comply with parts of the ANSI A108 series "Specifications for Installation of Ceramic Tile" that are referenced in TCNA installation methods, specified in tile installation schedules, and apply to types of setting and grouting materials used.
 - a. For the following installations, follow procedures in the ANSI A108 series of tile installation standards for providing 95 percent mortar coverage:
 - i. Tile floors consisting of tiles 8 by 8 inches or larger.
2. Extend tile work into recesses and under or behind equipment and fixtures to form complete covering without interruptions unless otherwise indicated. Terminate work neatly at obstructions, edges, and corners without disrupting pattern or joint alignments.
3. Accurately form intersections and returns. Perform cutting and drilling of tile without marring visible surfaces. Carefully grind cut edges of tile abutting trim, finish, or built-in items for straight aligned joints. Fit tile closely to electrical outlets, piping, fixtures, and other penetrations so plates, collars, or covers overlap tile.
4. Provide manufacturer's standard trim shapes where necessary to eliminate exposed tile edges.
5. Where accent tile differs in thickness from field tile, vary setting-bed thickness so that tiles are flush.

6. Jointing Pattern: Lay tile in grid pattern unless otherwise indicated. Lay out tile work and center tile fields in both directions in each space or on each wall area. Lay out tile work to minimize the use of pieces that are less than half of a tile. Provide uniform joint widths unless otherwise indicated.
 - a. For tile mounted in sheets, make joints between tile sheets same width as joints within tile sheets so joints between sheets are not apparent in finished work.
 - b. Where adjoining tiles on floor, base, walls, or trim are specified or indicated to be same size, align joints.
 - c. Where tiles are specified or indicated to be whole integer multiples of adjoining tiles on floor, base, walls, or trim, align joints unless otherwise indicated.
7. Joint Widths: Unless otherwise indicated, install tile with the following joint widths:
 - a. Pressed Floor Tile: 1/4 inch.
8. Porcelain Tile: 1/4 inch.
9. Lay out tile wainscots to dimensions indicated or to next full tile beyond dimensions indicated.
10. Expansion Joints: Provide expansion joints and other sealant-filled joints, including control, contraction, and isolation joints, where indicated. Form joints during installation of setting materials, mortar beds, and tile. Do not saw-cut joints after installing tiles.
 - a. Where joints occur in concrete substrates, locate joints in tile surfaces directly above them.
11. Stone Thresholds: Install stone thresholds in same type of setting bed as adjacent floor unless otherwise indicated.
 - a. At locations where mortar bed (thickset) would otherwise be exposed above adjacent floor finishes, set thresholds in modified dry-set improved modified dry-set mortar (thinset).
12. Metal Edge Strips: Install at locations indicated where exposed edge of tile flooring meets carpet, wood, or other flooring that finishes flush with top of tile where exposed edge of tile flooring meets carpet, wood, or other flooring that finishes flush with or below top of tile and no threshold is indicated.
13. Floor Sealer: Apply floor sealer to cementitious grout joints in tile floors according to floor-sealer manufacturer's written instructions. As soon as floor sealer has penetrated grout joints, remove excess sealer and sealer from tile faces by wiping with soft cloth.

C.1.3 INSTALLATION OF TILE BACKING PANELS

1. Install panels and treat joints according to ANSI A108.11 and manufacturer's written instructions for type of application indicated. Use modified dry-set mortar for bonding material unless otherwise directed in manufacturer's written instructions.

C.1.4 INSTALLATION OF WATERPROOF MEMBRANES

1. Install waterproof membrane to comply with ANSI A108.13 and manufacturer's written instructions to produce waterproof membrane of uniform thickness that is bonded securely to substrate.
2. Allow waterproof membrane to cure and verify by testing that it is watertight before installing tile or setting materials over it.

C.1.5 INSTALLATION OF CRACK ISOLATION MEMBRANES

1. Install crack isolation membrane to comply with ANSI A108.17 and manufacturer's written instructions to produce membrane of uniform thickness that is bonded securely to substrate.
2. Allow crack isolation membrane to cure before installing tile or setting materials over it.

C.1.6 ADJUSTING AND CLEANING

1. Remove and replace tile that is damaged or that does not match adjoining tile. Provide new matching units, installed as specified and in a manner to eliminate evidence of replacement.

2. Cleaning: On completion of placement and grouting, clean all ceramic tile surfaces so they are free of foreign matter.
 - a. Remove grout residue from tile as soon as possible.
 - b. Clean grout smears and haze from tile according to tile and grout manufacturer's written instructions but no sooner than 10 days after installation. Use only cleaners recommended by tile and grout manufacturers and only after determining that cleaners are safe to use by testing on samples of tile and other surfaces to be cleaned. Protect metal surfaces and plumbing fixtures from effects of cleaning. Flush surfaces with clean water before and after cleaning.

C.1.7 PROTECTION

1. Protect installed tile work with kraft paper or other heavy covering during construction period to prevent staining, damage, and wear. If recommended by tile manufacturer, apply coat of neutral protective cleaner to completed tile walls and floors.
2. Prohibit foot and wheel traffic from tiled floors for at least seven days after grouting is completed.
3. Before final inspection, remove protective coverings and rinse neutral protective cleaner from tile surfaces.

C.1.8 INTERIOR CERAMIC TILE INSTALLATION SCHEDULE

1. Interior Floor Installations, Concrete Subfloor:
 - a. TCNA F111 and ANSI A108.1A ANSI A108.1B ANSI A108.1C
 - b. Cement mortar bed (thickset) with waterproof membrane.
 - i Ceramic Tile Type: 11 5/8"x11 5/8"
 - ii Bond Coat for Cured-Bed Method: Standard dry-set.
 - iii Grout: Sand-portland cement grout.
2. Interior Wall Installations, Metal Studs or Furring:
 - a. TCNA W243: Thinset mortar on gypsum board.
 - i Ceramic Tile Type: 11 5/8"x5 5/8"
 - ii Thinset Mortar: Standard dry-set Modified dry-set Improved modified dry-set mortar.
 - iii Grout: Sand-portland cement Standard sanded cement
 - b. TCNA W244C or TCNA W244F: Thinset mortar on cementitious backer units or fiber-cement backer board over vapor-retarder membrane.
 - i Ceramic Tile Type: 11 5/8"x5 5/8"
 - ii Thinset Mortar: Standard dry-set
 - iii Grout: Sand-portland cement

C.2 Epoxy Floor Coating Construction

C.2.1 INSPECTION

1. Examine substrate and other required conditions and accept as satisfactory before commencing application.

C.2.2 GENERAL

1. Install epoxy coating in strict according with the Manufacturer's recommendations
2. Do not commence preparation and application until all other trades performing work in the area of work under this section have completed their work.
3. Substrate temperature shall be between 60oF and 90oF or as required by the manufacturer before, during, and until application has cured.

4. Maintain proper ventilation, permanent lighting and permanent heating during application and curing.
5. Prohibit smoking or the use of spark or flame devices in all mixing and application areas.
6. Provide protective gloves, shoes, goggles, and respirator when mixing and during applications.

C.2.3 CONCRETE SLAB CONDITION AND PREPARATION

1. Concrete Substrates: Provide sound concrete surfaces free of laitance, glaze, efflorescence, curing compounds, form-release agents, dust, dirt, grease, oil, and other contaminants incompatible with epoxy coating.
2. Prepare concrete slabs to receive epoxy coating according to ASTM C811.
3. Determine that slab is structurally sound, repair cracks, holes, pits with approved materials. Grind and fill concrete surface as required to meet tolerances specified by the epoxy coating manufacturer. Mechanically scarify concrete substrate by sandblasting, acid etching, grinding or portable shot blast cleaning system as may be required by the manufacturer to provide a proper surface or to remove curing compounds or other surface contaminants that would interfere with proper bond of system.
4. The epoxy coating manufacturer and installer shall confirm in writing to the contractor with a copy to the Authority's representative that the moisture content of the concrete slab is acceptable for application of the epoxy coating system and that the substrate is ready to receive the epoxy coating.
5. Sweep surfaces to remove loose particles, dust.
6. Remove grease, oil, sealers, mastics, paint, and all other contaminants using means recommended by flooring manufacturer.
7. Sawcut around drains, cleanouts, obstructions and all termination points.
8. Clean out cracks and joints; allow to dry, then tape over joints and cracks wider than 1/16" with 4" fiberglass tape and coat with epoxy/140 silica sand mix. Sprinkle colored ceramic quartz over bridging. Do not fill or cover expansion joints.
9. Fill hairline cracks without taping.
10. Tape at termination points and adjacent surfaces not to be coated with masking tape before applying body-coats, cove base, broadcast coat, topcoats and finish coats. Remove tape before applications dry.
11. Substrates for this work generally are depressed 1/4" lower than adjacent slabs; provide acceptable filler to align surface of epoxy coating with adjacent finish flooring.
12. Install metal edge strips in continuous lengths at edges of epoxy coating and bases, unless otherwise shown. Anchor strips solidly to substrate with stainless steel screws.

C.2.4 APPLICATION

Mix and apply each component of epoxy coating system in compliance with manufacturer's printed instructions to obtain an uninterrupted, uniform, monolithic surface.

System Thickness: 105 mils

1. Body Coats
 - a. Apply tape.
 - b. Mix 1 gallon resin with 1/2 gallon body coat hardener for 2 minutes. Add 2 quarts 20-40 silica sand and 1 quart 140 silica sand. Mix until sands are evenly distributed.
 - c. Pour mix onto surface in small quantities; stir contents just prior to pouring to prevent settling.
 - d. Trowel immediately with flat or 1/8" V-shaped notched trowel, spreading material evenly.

- e. After mix self-levels, evenly broadcast 20-40 silica sand so particles fall as vertically as possible into wet epoxy; avoid dropping handfuls. Saturate area until it appears to be uniformly dry. Repeat within a few minutes to cover wet or shiny appearing areas. Do not walk on surfaces after broadcasting.
 - f. Remove tape, close area to traffic, and allow system to dry.
2. Broadcast Coat
 - a. Mix colored ceramic quartz.
 - b. Apply tape.
 - c. Mix 1 gallon resin and 1/2 gallon body coat hardener. Add 2 quarts of mixed colored ceramic quartz and 1 quart 140 silica sand. Mix until contents are evenly distributed.
 - d. Pour mix onto surface in small quantities; stir contents just prior to pouring to prevent settling.
 - e. Trowel immediately with flat or 1/8" V-shaped notched trowel spreading material evenly. Wet into cove, if base has been applied.
 - f. After mix self-levels, evenly broadcast colored ceramic quartz so particles fall as vertically as possible into wet epoxy; avoid dropping handfuls. Saturate area until it appears to be uniformly dry. Repeat within a few minutes to cover wet or shiny appearing areas. Do not walk on surface after broadcasting. Remove tape, close to traffic and allow system to dry.
 - g. Remove excess quartz with stiff bristle broom.
 - h. Stone surface lightly with 24 grit carborundum stone. Sweep, vacuum, and retape in preparation for topcoats.
 3. Cove Base
 - a. Apply cove base mix to surfaces at locations shown to form cove base with height as indicated on Drawings, following Manufacturer's printed instructions and details covering taping, mixing, priming, troweling, sanding, and top coating.
 4. Standard Slip-Resistant Finish
 - a. Clear Epoxy Topcoats:
 - i. Mix 2 parts resin to 1 part topcoat hardener for 2 minutes.
 - ii. Tightly squeegee first topcoat to an even surface.
 - iii. After first topcoat dries, apply second topcoat.
 - iv. Tightly squeegee and roll immediately with 1/4" mohair nap roller to avoid streaking.
 - b. Clear Polyurethane Finish Coat:
 - c. Follow same procedure as for 4.a, 1), 2) and 3). Apply polyurethane topcoat with short-nap roller.

C.2.5 CLEANING

1. After completion of floor system, remove all excess materials and debris from work area.

C.2.6 PROTECTION

1. Close floor system work area to all traffic for 24 hours. Protect as recommended by system manufacturer.
2. Protect flooring from direct sunlight during the curing process.

C.3 Interior Painting Construction

C.3.1 EXAMINATION

1. Examine substrates and conditions, with Applicator present, for compliance with requirements for maximum moisture content and other conditions affecting performance of the Work.

2. Maximum Moisture Content of Substrates: When measured with an electronic moisture meter as follows:
 - a. Concrete: 12 percent.
 - b. Fiber-Cement Board: 12 percent.
 - c. Masonry (Clay and CMUs): 12 percent.
 - d. Wood: 15 percent.
 - e. Gypsum Board: 12 percent.
 - f. Plaster: 12 percent.
3. Gypsum Board Substrates: Verify that finishing compound is sanded smooth.
4. Plaster Substrates: Verify that plaster is fully cured.
5. Spray-Textured Ceiling Substrates: Verify that surfaces are dry.
6. Verify suitability of substrates, including surface conditions and compatibility, with existing finishes and primers.
7. Proceed with coating application only after unsatisfactory conditions have been corrected.
 - a. Application of coating indicates acceptance of surfaces and conditions.

C.3.2 PREPARATION

1. Comply with manufacturer's written instructions and recommendations in "MPI Architectural Painting Specification Manual" applicable to substrates and paint systems indicated.
2. Remove hardware, covers, plates, and similar items already in place that are removable and are not to be painted. If removal is impractical or impossible because of size or weight of item, provide surface-applied protection before surface preparation and painting.
 - a. After completing painting operations, use workers skilled in the trades involved to reinstall items that were removed. Remove surface-applied protection if any.
3. Clean substrates of substances that could impair bond of paints, including dust, dirt, oil, grease, and incompatible paints and encapsulants.
 - a. Remove incompatible primers and reprime substrate with compatible primers or apply tie coat as required to produce paint systems indicated.
4. Concrete Substrates: Remove release agents, curing compounds, efflorescence, and chalk. Do not paint surfaces if moisture content or alkalinity of surfaces to be painted exceeds that permitted in manufacturer's written instructions.
5. Masonry Substrates: Remove efflorescence and chalk. Do not paint surfaces if moisture content or alkalinity of surfaces or mortar joints exceeds that permitted in manufacturer's written instructions.
6. Steel Substrates: Remove rust, loose mill scale, and shop primer, if any. Clean using methods recommended in writing by paint manufacturer. but not less than the following:
 - a. SSPC-SP 2.
 - b. SSPC-SP 3.
 - c. SSPC-SP 7/NACE No. 4.
 - d. SSPC-SP 11.
7. Shop-Primed Steel Substrates: Clean field welds, bolted connections, and areas where shop paint is abraded. Paint exposed areas with the same material as used for shop priming to comply with SSPC-PA 1 for touching up shop-primed surfaces.
8. Galvanized-Metal Substrates: Remove grease and oil residue from galvanized sheet metal by mechanical methods to produce clean, lightly etched surfaces that promote adhesion of subsequently applied paints.

9. Aluminum Substrates: Remove loose surface oxidation.

C.3.3 INSTALLATION

1. Apply paints according to manufacturer's written instructions and to recommendations in "MPI Manual."
 - a. Use applicators and techniques suited for paint and substrate indicated.
 - b. Paint surfaces behind movable equipment and furniture same as similar exposed surfaces. Before final installation, paint surfaces behind permanently fixed equipment or furniture with prime coat only.
 - c. Paint front and backsides of access panels, removable or hinged covers, and similar hinged items to match exposed surfaces.
 - d. Do not paint over labels of independent testing agencies or equipment name, identification, performance rating, or nomenclature plates.
 - e. Primers specified in painting schedules may be omitted on items that are factory primed or factory finished if acceptable to topcoat manufacturers.
2. If undercoats or other conditions show through topcoat, apply additional coats until cured film has a uniform paint finish, color, and appearance.
3. Apply paints to produce surface films without cloudiness, spotting, holidays, laps, brush marks, roller tracking, runs, sags, ropiness, or other surface imperfections. Cut in sharp lines and color breaks.
4. Painting Fire-Suppression, Plumbing, HVAC, Electrical, Communication, and Electronic Safety and Security Work:
 - a. Paint the following work where exposed in equipment rooms:
 - i Uninsulated metal piping.
 - ii Uninsulated plastic piping.
 - iii Pipe hangers and supports.
 - iv Metal conduit.
 - v Plastic conduit.
 - vi Tanks that do not have factory-applied final finishes.
 - vii Duct, equipment, and pipe insulation having cotton or canvas insulation covering or other paintable jacket material.
 - b. Paint the following work where exposed in occupied spaces:
 - i Uninsulated metal piping.
 - ii Uninsulated plastic piping.
 - iii Pipe hangers and supports.
 - iv Metal conduit.
 - v Plastic conduit.
 - vi Duct, equipment, and pipe insulation having cotton or canvas insulation covering or other paintable jacket material.
 - vii Other items as directed by Architect.
 - c. Paint portions of internal surfaces of metal ducts, without liner, behind air inlets and outlets that are visible from occupied spaces.

C.3.4 FIELD QUALITY CONTROL

1. Dry-Film Thickness Testing: Owner may engage the services of a qualified testing and inspecting agency to inspect and test paint for dry-film thickness.
 - a. Contractor shall touch up and restore painted surfaces damaged by testing.
 - b. If test results show that dry-film thickness of applied paint does not comply with paint manufacturer's written recommendations, Contractor shall pay for testing and apply additional coats as needed to provide dry-film thickness that complies with paint manufacturer's written recommendations.

C.3.5 CLEANING AND PROTECTION

1. At end of each workday, remove rubbish, empty cans, rags, and other discarded materials from Project site.
2. After completing paint application, clean spattered surfaces. Remove spattered paints by washing, scraping, or other methods. Do not scratch or damage adjacent finished surfaces.
3. Protect work of other trades against damage from paint application. Correct damage to work of other trades by cleaning, repairing, replacing, and refinishing, as approved by Architect, and leave in an undamaged condition.
4. At completion of construction activities of other trades, touch up and restore damaged or defaced painted surfaces.

C.3.6 INTERIOR PAINTING SCHEDULE

Note: All walls will be painted in light whites and beige family of colors. Submit a set colors samples for architect selection for walls and ceilings as well as exposed steel and other elements.

1. Concrete Substrates, Nontraffic Surfaces:
 - a. High-Performance Architectural Latex System, MPI INT 3.1C:
 - i Prime Coat: Primer, alkali resistant, water based, MPI #3.
 - ii Intermediate Coat: Latex, interior, high performance architectural, matching topcoat.
 - iii Topcoat: Latex, interior, high performance architectural, semigloss (MPI Gloss Level 5), MPI #141.
2. Cement Board Substrates:
 - a. Latex System, MPI INT 3.3A:
 - i Prime Coat: Primer, alkali resistant, water based, MPI #3.
 - ii Intermediate Coat: Latex, interior, matching topcoat.
 - iii Topcoat: Latex, interior, semigloss (MPI Gloss Level 5), MPI #54.
3. Steel Substrates:
 - i Prime Coat: Primer, alkyd, anticorrosive, for metal, MPI #79.
 - ii Prime Coat: Shop primer specified in Section where substrate is specified.
 - iii Intermediate Coat: Latex, interior, matching topcoat.
 - iv Topcoat: Latex, interior, gloss (MPI Gloss Level 6, except minimum gloss of 65 units at 60 degrees), MPI #114.
 - b. Alkyd over Shop-Applied Quick-Drying Shop Primer System, MPI INT 5.1W:
 - i Prime Coat: Primer, quick dry, for shop application, MPI #275.
 - ii Intermediate Coat: Alkyd, interior, matching topcoat.
 - iii Topcoat: Alkyd, interior, gloss (MPI Gloss Level 6), MPI #48.

4. Galvanized-Metal Substrates:
 - a. Latex System, MPI INT 5.3A, MPI INT 5.3J:
 - i Prime Coat: Primer, galvanized, cementitious, MPI #26.
 - ii Prime Coat: Primer, galvanized, water based, MPI #134.
 - iii Intermediate Coat: Latex, interior, matching topcoat.
 - iv Topcoat: Latex, interior, gloss (MPI Gloss Level 6, except minimum gloss of 65 units at 60 degrees), MPI #114.
5. Gypsum Board Substrates:
 - a. Institutional Low-Odor/VOC Latex System, MPI INT 10.1D:
 - i Prime Coat: Primer sealer, latex, interior, MPI #50.
 - ii Intermediate Coat: Latex, interior, institutional low odor/VOC, matching topcoat.
 - iii Topcoat -All ceilings: Latex, interior, institutional low odor/VOC (MPI Gloss Level 4), MPI #146.
 - iv Topcoat -Non Public rooms walls: Latex, interior, institutional low odor/VOC, semigloss (MPI Gloss Level 5), MPI #147.
 - v Topcoat-All public area walls: Latex, interior, institutional low odor/VOC, gloss (MPI Gloss Level 6), MPI #148.

D Measurement

The department will measure Finishing by the square foot, acceptably completed. The quantity to be paid for will be the sum of the areas of exposed faces at the locations shown on the plans. Area will be determined from measurements taken in the plane of the exposed face of the finishes.

E Payment

The department will pay for measured quantities at the contract unit price under the following bid item:

ITEM NUMBER	DESCRIPTION	UNIT
SPV.0165.07	Finishes	SF

Payment is full compensation for furnishing and installation of all tiling, and interior painting work in the project.

71. Temporary Shoring Railroad, Item SPV.0165.08

A Description

This special provision describes furnishing and installing temporary shoring at locations alongside railroad tracks as shown on the plan and conforming to the shoring design requirements.

B Materials

B.1 Shoring Design

Provide an effective shoring system capable of withstanding Coopers E-80 live load surcharge, and which is in compliance with OSHA and Federal Railroad Administration (FRA) requirements. For reference, use "Guidelines for Excavations on CPR Property" published by Canadian Pacific Railway. A copy of these guidelines may be obtained from the department at the Bureau of Railroads & Harbors. Where conflicts exist, the standard specifications, special provisions and plans shall supersede these guidelines.

Refer to standard spec 107.17(6) and (7) regarding the development and submittal of shop drawings, detailed plans, and computations for temporary construction near the CP's tracks. Include in the submitted drawings and plans the proposed method of installation and removal of the shoring not included in the contract plans. In all calculations, take into consideration railroad surcharge loading and design the shoring to meet Coopers E-80 live loading.

C Construction

The CP will coordinate train operations with the contractor to the extent possible, consistent with its operational requirements. The number and duration of work windows free of train operations available per day will vary depending on operational requirements. At the end of each window, leave the construction area in a condition that will allow for safe and normal train operations. Do not leave shoring extended above the top of rail within 12'-0" from the centerline of the nearest track. Train operations and available windows for work and hours available for work within windows are subject to change. Contact Brian Osborne, Manager Public Works at (612) 330-4555 or brian_osborne@cpr.ca at least three working days in advance of construction operations that require implementation of the temporary shoring.

Provide, install and maintain adequate protection for people within the CP right-of-way. Cover, guard, and/or protect all excavations, holes, or trenches within the CP's right-of-way when they are not being worked on. When leaving work site areas at night and over weekends, secure the areas and leave them in a condition that will ensure that railroad employees and other personnel, who may be working or passing through the area, are protected around excavations. Install handrails that are parallel to the track and not less than 9'-0" from the centerline of the nearest track. Handrails, fences, or other barrier methods must meet OSHA and FRA requirements. Backfill all excavations as soon as possible.

Upon completion of the need for the temporary shoring, remove the shoring or cut-off the shoring 4'-6" below the top of the adjacent rail. Backfill the space that is excavated but not occupied by the new permanent construction conforming to standard spec 206.3.13.

D Measurement

The department will measure Temporary Shoring Railroad in by the square foot, acceptably completed. The quantity to be paid for will be the sum of the areas of exposed faces of shoring constructed at the locations shown on the plans. Area will be determined from measurements taken in the plane of the exposed face of the shoring.

E Payment

The department will pay for the measured quantities at the contract unit price under the following bid item:

ITEM NUMBER	DESCRIPTION	UNIT
SPV.0165.08	Temporary Shoring Railroad	SF

Payment for Temporary Shoring Railroad is full compensation for providing a verified design of the shoring; providing shop drawings and detailed plans; furnishing and hauling materials to each location; installing the shoring; maintaining the shoring as needed; removing the shoring; and backfilling upon completion of the need for the shoring.

Temporary shoring not required by the plans and installed for the convenience of the contractor's operations shall be considered incidental to work under this contract and will not be measured and paid for under this item.

ADDITIONAL SPECIAL PROVISION 1 (ASP 1) FOR TRANSPORTATION ALLIANCE FOR NEW SOLUTIONS (TrANS) PROGRAM EMPLOYMENT PLACEMENTS AND APPRENTICESHIPS

The Safe, Accountable, Flexible, Efficient Transportation Equity Act: A Legacy for Users (SAFETEA-LU), Section 5204(e) – Surface Transportation Workforce Development Training and Education, provides for 100 percent Federal funding if the core program funds are used for training, education, or workforce development purposes, including “pipeline” activities. The core programs includes: Congestion Mitigation and Air Quality Improvement (CMAQ) Program, Highway Bridge Program (HBP), Interstate Maintenance (IM), National Highway System (NHS), and Surface Transportation Program (STP). These workforce development activities cover surface transportation workers, including OJT/SS programs for women and minorities as authorized in 23 U.S.C. §140(b).

TrANS is an employment program originally established in 1995 in Southeastern Wisconsin. Currently TrANS has expanded to include TrANS program locations to serve contractors in Southeast (Milwaukee and surrounding counties), Southcentral (Dane County and surrounding counties including Rock County), and most Northeastern Wisconsin counties from locations in Keshena, Rhinelander and surrounding far Northern areas. TrANS attempts to meet contractor’s needs in other geographic locations as possible. It is an industry driven plan of services to address the outreach, preparation, placement and retention of women, minorities and non-minorities as laborers and apprentices in the highway skilled trades. These candidate preparation and contractor coordination services are provided by community based organizations. For a list of the TrANS Coordinators contact the Disadvantaged Business Enterprise Office at (414) 438-4583 in Milwaukee or (608) 266-6961 in Madison. These services are provided to you at no cost.

I. BASIC CONCEPTS

Training reimbursements to employing contractors for new placements, rehires or promotions to apprentice of TrANS Program graduates will be made as follows:

- 1) **On-the-Job Training, Item ASP.1T0G, ASP 1 Graduate.** At the rate of \$5.00 per hour on federal aid projects when TrANS graduates are initially hired, or seasonally rehired, as unskilled laborers or the equivalent.

Eligibility and Duration: To the employing contractor, for up to 2000 hours from the point of initial hire as a TrANS program placement.

Contract Goal: To maintain the intent of the Equal Employment Opportunity program, it is a goal that 9 (number) TrANS Graduate(s) be utilized on this contract.
- 2) **On-the-Job Training, Item ASP.1T0A, ASP 1 Apprentice.** At the rate of \$5.00 per hour on federal aid projects at the point when an employee who came out of the TrANS Program is subsequently entered into an apprenticeship contract in an underutilized skilled trade (this will include the Skilled Laborer Apprenticeship when that standard is implemented).

Eligibility and Duration: To the employing contractor, for the length of time the TrANS graduate is in apprentice status.

Contract Goal: To maintain the intent of the Equal Employment Opportunity program, it is a goal that 2 (number) TrANS Apprentice(s) be utilized on this contract.
- 3) The maximum duration of reimbursement is two years as a TrANS graduate plus time in apprentice status.

- 4) If a TrANS program is not available in the contractor's area and another training program is utilized, payment of On-the-Job Training hours may be approved by the Wisconsin Department of Transportation (WisDOT) if the training program meets the established acceptance criteria. Only On-the-Job Training Hours accumulated after WisDOT approval will be reimbursed as specified under Items ASP.1T0G and ASP.1T0A. For more information, contact the Disadvantaged Business Enterprise Office at the phone numbers listed above.
- 5) WisDOT reserves the right to deny payments under items ASP.1T0G and ASP.1T0A if the contractor either fails to provide training or there is evidence of a lack of good faith in meeting the requirements of this training special provision.

II. RATIONALE AND SPECIAL NOTE

The \$5.00 per hour now being paid for TrANS placements is intended to cover the duration of two years to allow for reaching entry-level laborer status. An additional incentive, the \$5.00 rate, would promote movement into the underutilized skilled trades' apprenticeships and applies until the individual completes their apprenticeship. These incentives benefit TrANS candidates by giving them a better opportunity to enter a skilled trade; benefits contractors who will be assisted in meeting their EEO profiles and goals; and benefits the public who will see the program reinforce larger public-private employment reform in Wisconsin. The pool of TrANS graduates was created for the purpose of addressing underutilization in the skilled trades, an objective that is further reinforced by a parallel retention pilot program, known as the Companywide Reporting. *Whether or not reimbursement is involved, the WisDOT reassures contractors who are in the Companywide Program that TrANS placements still contribute toward fulfilling the new hire goal of 50% women and minorities.* Based on data administered by United States Department of Labor (US DOL), the highway skilled trades remain underutilized for women statewide (less than 6.9%); and for minorities in all counties (% varies by county).

NOTE: Unless using other advancement strategies, contractors are encouraged to use some or all of this monetary incentive to offset the cut in hourly wages an individual may incur when entering an apprenticeship if the full general laborer hourly rate has been previously paid. No special accounting measures are required.

III. IMPLEMENTATION

The implementation of ASP 1 is intended to cover only the amount of time it takes for underutilization to be resolved across the trades. This will be measured annually at the county and/or state levels using data administered by WisDWD in relation to goals set by the USDOL-OFCCP. With appropriate state and federal approvals, we may also do some measurement at the company level.

It is the contractor's responsibility to note on their Certified Payrolls if their employee is a TrANS graduate or a TrANS apprentice. The District EEO Coordinators utilize the information on the Certified Payrolls to track the hours accumulated by TrANS Graduates and TrANS apprentices on WisDOT contracts. Payment under this ASP 1 is made based on the hours recorded off of the Certified Payrolls. Tracking may eventually include improved linkages with the WisDWD apprentice database, information from company and committee level sources.

TrANS is nondiscriminatory by regulation, and is a tool for optional use by contractors to address the underutilization of women and minorities as laborers and apprentices in our industry's skilled trades.

IV. TRANS TRAINING

As part of the contractor's equal employment opportunity affirmative action program, training shall be provided to employees enrolled in apprenticeship and on-the-job training programs as follows:

The contractor shall provide on-the-job training aimed at developing full journey workers in the type of trade or job classifications involved. In the event the contractor subcontracts a portion of the contract work, the contractor shall determine how many, if any, of the trainees are to be trained by the subcontractor provided, however, that the contractor shall retain the primary responsibility for meeting the training requirements imposed by this special provision. The contractor shall also insure that this training special provision is made applicable to such subcontract.

Training and upgrading of minorities and women toward journey workers status is a primary objective of this training special provision. Accordingly, the contractor shall make every effort to enroll minority trainees and women (e.g., by conducting systematic and direct recruitment through public and private sources likely to yield minority trainees and women trainees); to the extent such persons are available within a reasonable area of recruitment. The contractor will be given an opportunity and will be responsible for demonstrating the steps that they have taken in pursuance thereof, prior to determination as to whether the contractor is in compliance with this training special provision. This training commitment is not intended, and shall not be used, to discriminate against any applicant for training, whether a member of a minority group or not.

No employee shall be employed as a trainee in any classification in which they have successfully completed a training course leading to journey workers status or in which they have been employed as a journey worker. The contractor should satisfy this requirement by including appropriate questions in the employee application or by other suitable means. Regardless of the method used, the contractor's records should document the findings in each case.

V. APPRENTICESHIP TRAINING

The Federal Highway Administration's (FHWA) policy is to require full use of all available training and skill improvement opportunities to assure increased participation of minority groups,

disadvantaged persons and women in all phases of the highway construction industry. The FHWA On-the-Job Training (OJT) Program requires the State transportation agencies (STAs) to establish apprenticeships and training programs targeted to move women, minorities, and disadvantaged individuals into journey-level positions to ensure that a competent workforce is available to meet highway construction hiring needs, and to address the historical under-representation of members of these groups in highway construction skilled crafts.

The OJT Supportive Services (OJT/SS) Program was established in Title 23 Code of Federal Regulations (CFR), Part 230) to supplement the OJT program and support STA training programs by providing services to highway construction contractors and assistance to highway construction apprentices and trainees. The primary objectives of OJT/SS are:

- (1) To increase the overall effectiveness of the State highway agencies' approved training programs.
- (2) To seek other ways to increase the training opportunities for women, minorities, and disadvantaged individuals.

The STAs are responsible for establishing procedures, subject to the availability of Surface Transportation and Bridge Funds under 23 U.S.C. §140(b) (Nondiscrimination), for the provision of supportive services with respect to training programs approved under 23 CFR, Part 230(a) (Equal Employment Opportunity on Federal and Federal-aid Construction Contracts – including Supportive Services).

The contractor and subcontractor shall maintain records to demonstrate compliance with these apprenticeship requirements. Reasonable exemptions and modifications to and from any or all of these requirements will be determined by the Wisconsin Department of Transportation-Civil Rights Office. A request for an exemption or modification, with justification, shall be made in writing, addressed to WisDOT Civil Rights Office, 4802 Sheboygan Avenue, P.O. Box 7965, Rm. 451, Madison, WI 53707.

ADDITIONAL SPECIAL PROVISION 3

DISADVANTAGED BUSINESS ENTERPRISE (DBE) PROGRAM IMPLEMENTATION

Authority

Wisconsin Department of Transportation (WisDOT) is a recipient of funds from the US Department of Transportation's Federal Highway Administration. The DBE program is a federal program applicable on all contracts administered by WisDOT that include federal-aid highway funds. The authority for the DBE program is the Transportation Bill as approved by Congress periodically. DBE program guidance and requirements are outlined in the Code of Federal Regulations at 49 CFR Part 26. This contract is subject to DBE provisions because it is financed with federal-aid-highway funds. Additionally, this contract is subject to the *State of Wisconsin Standard Specifications for Highway and Structure Construction* and all applicable contract documents.

Requirements

Pursuant to the federal DBE program regulation at 49 CFR Part 26, a contractor's failure to comply with any provision of the DBE program regulatory provisions will be considered a material breach of contract. This is nonnegotiable.

If a contractor fails to carry out the DBE program requirements and/or the Required Contract Provisions for Federal Aid Contracts (FHWA 1273) referenced in this document, sanctions will be assessed depending upon the facts, reasoning, severity, and remedial efforts of the contractor that may include: termination of contract, withholding payment, assessment of monetary sanctions, and/or suspension/debarment proceedings that could result in the disqualification of the contractor from bidding for a designated period of time.

- (1) The Commitment to Subcontract to DBE (Form DT1506 or digital submittal), Attachments A, and Good Faith Effort Documentation (Form DT1202) will be submitted as described in Section 2.
- (2) Any change to DBE Commitments thereafter must follow modification of DBE subcontracting commitment as described in Section 9.
- (3) The Department requires this list of DBE subcontractors from all bidders at time of bid to ensure the lowest possible cost to taxpayers and fairness to other bidders and subcontractors. Bid shopping is prohibited.
- (4) The contractor must utilize the specific DBE firms listed in the approved DBE Commitment to perform the work and/or supply the materials for which the DBE firm is listed unless the contractor obtains written consent in advance from WisDOT. The contractor will not be entitled to payment for any work or materials on the approved DBE Commitment that is not performed or supplied by the listed DBE without WisDOT's written consent.

Description

The Wisconsin Department of Transportation is committed to the compliant administration of the DBE Program. The DBE provisions work in tandem with FHWA 1273 and WisDOT's *Standard Specifications for Highway and Structure Construction* and *Construction and Materials Manual*. The WisDOT Secretary is signatory to assurances of department-wide compliance.

The Department assigns the contract DBE goal as a percentage of work items that could be performed by certified DBE firms on the contract. The assigned DBE goal is expressed on the bid proposal as a percentage applicable to the total contract bid amount.

- (1) WisDOT identifies the assigned DBE goal in its contract advertisements and posts the contract DBE goal on the cover of the bidding proposal. The contractor can meet the assigned contract DBE goal by subcontracting work to a DBE firm or by procuring services or materials from a DBE firm.

- (2) Under the contract, the prime contractor should inform, advise, and develop participating DBE firms to be more knowledgeable contractors who are prepared to successfully complete their contractual agreement through the proactive provision of assistance in the following areas:
- Produce accurate and complete quotes
 - Understand highway plans applicable to their work
 - Understand specifications and contract requirements applicable to their work
 - Understand contracting reporting requirements
- (3) The Department encourages contractors to assist DBE subcontractors more formally by participating in WisDOT's Business Development program as a mentor, coach, or resource. For comprehensive information on the Disadvantaged Business Enterprise Program, visit the Department's Civil Rights and Compliance Section website at: <http://wisconsindot.gov/Pages/doing-bus/civil-rights/dbe/default.aspx>

1. Definitions

Interpret these terms, used throughout this additional special provision, as follows:

- a. **Assigned DBE Contract Goal:** The percentage shown on the cover of the Highway Work Proposal that represents the feasible level of DBE participation for each contract. The goal is calculated using the Engineer's Estimate and DBE Interest Report. Goal assignment includes review of FHWA funds, analyzes bid items for subcontract opportunity and compatibility with DBE certified firm work codes. Additional factors considered include proximity, proportion, and regulations.
- b. **Bid Shopping:** In construction law, bid shopping is the practice of divulging a subcontractor's bid to another prospective contractor(s) before or after the award of a contract to secure a lower bid.
- c. **DBE:** Disadvantaged Business Enterprise – A for-profit small business concern where socially and economically disadvantaged individuals own at least a 51% interest and control management and daily business operations.
- d. **DBE Commitment:** The DBE Commitment is identified in the Commitment to Subcontract to DBE (Form DT1506) and is expressed as the amount of DBE participation the prime contractor has secured. The DT1506, a contract document completed by the bidder, is required to be considered a responsive bidder on an FHWA-funded contract that has an assigned DBE goal. The prime contractor will have the option to submit the DT1506 digitally, as an entry with the bid in Bid Express, or as an attachment to the bid.
- e. **DBE Utilization:** The actual participation of a DBE subcontractor on a project. WisDOT verifies DBE utilization through review of the DBE Commitment, payments to subcontractors, and contract documentation. The Prime Contractor receives DBE credit for payments made to the DBE firms performing the work listed on the approved DBE Commitment, and those submitted after approved commitment with Attachment A.
- f. **Good Faith Effort:** Legal term describing a diligent and honest effort taken by a reasonable person under the same set of facts or circumstances. For DBE subcontracting, the bidder must show that it took all necessary and reasonable steps to achieve the assigned DBE goal by the scope, intensity, and appropriateness of effort that could reasonably be expected for a contractor to obtain sufficient DBE participation.
- g. **Manufacturer:** A firm that operates or maintains a factory or establishment that produces, on the premises, the materials, supplies, articles, or equipment required under the contract.
- h. **Reasonable Price:** Contractors are expected to assess reasonable price by analyzing the contract scope for DBE subcontract feasibility and comparing common line items in DBE and non-DBE subcontract quotes for the same work. Per federal regulation, reasonable price is not necessarily the lowest price.
- i. **Supplier:** A firm that owns, operates, or maintains a store, warehouse, or other establishment in which the materials, supplies, articles, or equipment required under the contract are bought, kept in stock, and regularly sold or leased to the public.
- j. **Tied quote:** Subcontractor quote that groups multiple bid/line items at a bundled/package price with a notation that the items within the quote will not be separated.

2. WisDOT DBE Program Compliance

a. Documentation Submittal

- The Commitment to Subcontract to DBE (Form DT1506 or digital submittal) must be submitted at the time of bid (Tuesday) by all prime contractors.
- Attachments A OR quotes from all DBEs included in the Commitment must be submitted at bid (Tuesday) **OR**
- Within one-hour following bid submittal by ALL prime contractors via eSubmit (Tuesday).
- If only DBE quotes were submitted, all remaining signed Attachments A must be submitted within 24-hours of bid closing via eSubmit (Wednesday).
- If the assigned DBE contract goal is not met, Documentation of Good Faith Effort (Form DT1202) and supporting documentation must be submitted within 24-hours of bid closing (Wednesday) via eSubmit. [Instructions for eSubmit.](#)

**Bidders have the option of submitting the DBE Commitment at the time of bid via direct entry through Bid Express OR with attachment of Form DT1506 (Commitment to Subcontract to DBE). The DBE Commitment entered with bid is the digital form of the DT1506. Separate submission of Form DT1506 is not required if the DBE Commitment is entered in Bid Express. Form DT1202, if applicable, is no longer required to be submitted at time of bid; submit DT1202 within the 24-hour supplemental time frame following bid closing.

The DBE Office will not certify Good Faith Effort and the Bureau of Project Development will consider the bid nonresponsive if the contractor fails to furnish the DBE Commitment (digitally entered into the bid OR Form DT1506 as an attachment), Attachments A, and Form DT1202 if applicable, as required. See sample forms in the Appendix.

b. Verification of DBE Commitment

The documentation related to DBE subcontract commitment submitted prior to contract award is evaluated as follows:

(1) DBE Goal Met

If the bidder indicates that the contract DBE goal is met, the Department will evaluate the DBE Commitment submitted with bid OR Form DT1506, and Attachments A to verify the actual DBE percentage calculation. If the DBE Commitment is verified, the contract is eligible for award with respect to the DBE Commitment.

(2) DBE Goal Not Met

- a) If the bidder indicates a bid percentage on the DBE Commitment that does not meet the assigned DBE contract goal, the bidder must request alternative evaluation of good faith effort through submission of Form DT1202 (Documentation of Good Faith Effort) within 24-hours of bid including narrative description. Supplementary documentation of good faith effort that supports the DT1202 submission is also due within 24-hours of bid submission and prior to bid posting. The Department will review the bidder's DBE Commitment and evaluate the bidder's good faith efforts submission.
- b) Following evaluation of the bidder's Good Faith Effort documentation the bidder will be notified that the Department intends to:
 1. *Approve* the request (adequate documentation of GFE has been submitted) - no conditions placed on the contract with respect to the DBE Commitment;
 2. *Deny* the request (inadequate documentation of GFE has been submitted) - the contract is viewed as non-responsive per Wisconsin Standard Specifications for Highway and Structure Construction and will not be executed.

- c) If the Department denies the bidder's request, the contract is ineligible for award. The Department will provide a written explanation for denying the request to the bidder. The bidder may appeal the Department's denial (see Section 4).

Supplemental good faith effort documentation must be submitted through eSubmit.

3. Department's Criteria for Good Faith Effort Documentation

The Federal-aid Construction Contract Provision, referenced as FHWA-1273, explicitly states that the prime contractor shall be responsible for all work performed on the contract by piecework, station work, or subcontract.

The contractor shall take all necessary and reasonable steps to ensure nondiscrimination in the administration of the contract including assurances of equal employment opportunity laws, DBE regulations, and affirmative action. Compliance encompasses responsible and responsive action, documentation, and good faith effort.

Contractually, all contractors, subcontractors, and service providers on the contract are bound by FHWA 1273 and DBE program provisions. **Prime contractors should encourage subcontractors to utilize DBE firms whenever possible to contribute to the assigned DBE contract goal.**

Bidders are required to document good faith effort. Per 49 CFR Part 26.53, good faith effort is demonstrated in one of two ways. The bidder:

- (1) Documents that it has obtained enough DBE participation to meet the goal; OR
- (2) Documents that it made adequate good faith efforts to meet the goal, even though it did not succeed

Appendix A of 49 CFR Part 26 provides guidance concerning good faith efforts. WisDOT evaluates good faith effort on a contract basis just as each contract award is evaluated individually.

The efforts employed by the bidder should be those that WisDOT can reasonably expect a bidder to take to actively and aggressively obtain DBE participation sufficient to meet the DBE contract goal. The Department will only approve demonstration of good faith effort if the bidder documents the quality, quantity, and intensity of the variety of activities undertaken that are commensurate with expected efforts to meet the stated goal.

The Department, in conjunction with industry stakeholders, has developed the following guidance for contractor good faith effort activity. The guidance and the attached appendices provide a framework for the actions required by all parties in the processing and evaluation of bidder's total efforts to achieve the project specific DBE goal prior to the bid letting date.

a. Solicitation Guidance for Prime Contractors:

- (1) Document all efforts and decisions made toward achieving the DBE goal on the contract. The bidder should use WisDOT-approved DBE outreach tools, including the UCP DBE Directory and the Bid Express Small Business Network to foster DBE participation on all applicable contracts.
- (2) As needed, request assistance with DBE outreach and follow-up by contacting the Department's DBE Support Services Office by phone or email request at least 14 days prior to the bid letting date. Phone numbers are (414) 438-4584 and/or (608) 267-3849; Fax: (414) 438-5392; E-mail: DBE_Alert@dot.wi.gov
- (3) Participate in and document a substantive conversation with at least one DBE firm per Let, to discuss questions, concerns, and any other contract related matters that may be applicable to the DBE firm. Guidelines for this conversation are provided in Appendix A of ASP-3.
- (4) Request quotes by identifying potential items to subcontract and solicit. In their initial contacts, contractors are strongly encouraged to include a single page, detailed list of items for which they are accepting quotes, by project, within a letting. *See attached sample entitled "Sample Contractor Solicitation Letter" in Appendix B.* Prime contractors should also indicate a willingness to accept quotes in areas they are planning to perform themselves, as required by federal rules. In some cases, it might be appropriate to use DBE firms to do work in a prime contractor's area of specialization.

- i. Solicit quotes from certified DBE firms who match possible items to subcontract using all reasonable and available means. Additionally, forward copies of solicitations highlighting the work areas for which quotes are being sought to DBE_Alert@dot.wi.gov
- ii. Acceptable outreach tools include SBN (Small Business Network, see Appendix C): <https://www.bidx.com/wi/main>, postal mail, email, fax, and phone.
 - a. Contractors must ask DBE firms for a response in their solicitations. See *Sample Contractor Solicitation Letter*, Appendix B. This letter may be included as an attachment to the sub-quote request.
 - b. Solicit quotes at least 10 calendar days prior to the letting date to allow DBE firms sufficient time to respond. Prime contractors should contact DBE firms early, asking if they need help organizing their quote, assistance confirming equipment needs, or other assistance supporting their submission of a competitive quote for their services.
 - c. A follow up solicitation should take place within 5 calendar days of the letting date. Email and/or SBN are the preferred method for the solicitation.
- iii. Upon request, provide interested DBE firms with adequate information about plans, specifications, and the requirements of the contract by letter, information session, email, phone call, and/or referral.
- iv. When potential exists, the contractor should advise interested DBE firms on how to obtain bonding, line of credit, or insurance if requested.
- v. Document DBE firm's interest in quoting by taking appropriate steps to follow up initial solicitation with:
 - a. Email to all prospective DBE firms in relevant work areas
 - b. Phone call log to DBE firms who express interest via written response or call
 - c. Fax/letter confirmation
 - d. Signed copy of record of subcontractor outreach effort

b. Guidance for Evaluating DBE quotes

- (1) Quote evaluation practices required to evaluate DBE quotes:
 - i. Reasonable Price: Contractors are expected to assess reasonable price by analyzing the contract scope for DBE subcontract feasibility and comparing common line items in DBE and non-DBE subcontract quotes for the same work. Per federal regulation, reasonable price is not necessarily the lowest price. See 49 CFR Part 26, Appendix A. IV.D(2).
- (2) Documentation submitted by the prime of the following evaluation is required to evaluate DBE quotes by contractors:
 - i. Evaluation of DBE firm's ability to perform "possible items to subcontract" using legitimate reasons, including but not limited to, **a discussion** between the prime and DBE firm regarding its capabilities prior to the bid letting. If lack of capacity is the reason for not utilizing the DBE firm's quote, the prime is required to contact the DBE by phone and email regarding their ability to perform the work indicated in the UCP directory listed as their work area by NAICS code. Only the work area indicated by the NAICS code(s) listed in the UCP directory can be counted toward DBE credit. Documentation of the conversation is required.
 - a. In striving to meet an assigned DBE contract goal, contractors are expected to use DBE quotes that are responsive and reasonable. This includes DBE quotes that are not the low quote.
 - b. Additional evaluation - Evaluation of DBE quotes with tied bid items. Typically, this type of quoting represents a cost saving but is not clearly stated as a discount. Tied quotes are usually presented as an 'all or none' quote. When non-DBE subcontractors submit tied bid items in their quotes, the DBE firm's quote may not appear competitive. In such a case, the following steps are taken in comparing the relevant quotes. These are qualitative examples:

- i Compare bid items common to both quotes, noting the reasonableness in the price comparison.
- ii Review quotes from other firms for the bid items not quoted by the DBE firm to see if combining both can provide the same competitive advantage that the tied bid items offered.

See Appendix D – *Good Faith Effort Evaluation Measures* and Appendix E - *Good Faith Effort Best Practices*.

c. Requesting Good Faith Effort Evaluation At the time of bid- if the DBE goal is not met in full, the prime contractor must indicate they will file form DT1202- Documentation of Good Faith Effort within 24-hours of bid submission. Supplementary documentation of good faith effort that supports the DT1202 submission is also due within 24-hours of bid submission and prior to bid posting. Supporting documentation for the DT1202 is to include the following:

- (1) Solicitation Documentation: The names, addresses, email addresses, and telephone numbers of DBE firms contacted along with the dates of both initial and follow-up contact; electronic copies of all written solicitations to DBE firms. A printed copy of SBN solicitation is acceptable.
- (2) Selected Work Items Documentation: Identify economically feasible work units to be performed by DBEs to include activities such as: list of work items to be performed; breaking up of large work items into smaller tasks or quantities; flexible time frames for performance and delivery schedules.
- (3) Documentation of Project Information provided to interested DBEs: A description of information provided to the DBE firms regarding the plans, specifications, and estimated quantities for portions of the work to be performed by that DBE firm.
- (4) Documentation of Negotiation with Interested DBEs: Provide sufficient evidence to demonstrate that good faith negotiations took place. Merely sending out solicitations requesting bids from DBEs does not constitute sufficient good faith efforts.
- (5) Documentation of Sound Reasoning for Rejecting DBEs and copies of each quote received from a DBE firm and, if rejected, copies of quotes from non-DBEs for same items.
- (6) Documentation of Assistance to Interested DBEs- Bonding, Credit, Insurance, Equipment, Supplies/Materials
- (7) Documentation of outreach to Minority, Women, and Community Organizations and other DBE Business Development Support: Contact organizations and agencies for assistance in contacting, recruiting, and providing support to DBE subcontractors, suppliers, manufacturers, and truckers at least 14 days before bid opening. Participate in or host activities such as networking events, mentor-protégé programs, small business development workshops, and others consistent with DBE support.

If the Good Faith Effort documentation is deemed adequate, the request will be approved and the DBE office will promptly notify the Prime Contractor and Bureau of Project Development.

If the DBE Office denies the request, the Prime Contractor will receive written correspondence outlining the reasons. The Department encourages the Prime Contractor to communicate with DBE staff to clarify any questions related to meeting goals and/or contractor demonstration of good faith efforts.

If the contract is awarded, the Prime Contractor must obtain written consent from the DBE Office to change or replace any DBE firm listed on the approved DBE Commitment. No contractor, prime or subsequent tier, shall be paid for completing work assigned to a DBE subcontractor on an approved DBE Commitment unless WisDOT has granted permission for the reduction, replacement, or termination of the assigned DBE in writing. If a prime contractor or a subcontractor on any tier uses its own forces to perform work assigned to a DBE on an approved DBE Commitment, **they will not be paid for the work**. Any changes to DBE Commitment after the approval of the DBE Commitment must be reviewed and approved by the DBE Office prior to the change (see Section 9).

Additional resources for demonstrating and tracking good faith effort can be found on the “Contracting with a DBE” webpage in the [ASP-3 and Good Faith Effort Guidance](#) section.

4. Bidder's Documentation of Good Faith Effort Evaluation Request Appeal Process

A bidder can appeal the Department's decision to deny the bidder's demonstration of Good Faith Effort through Administrative Reconsideration. The bidder must provide a written justification refuting the specific reasons for denial as stated in the Department's denial notice. The bidder may meet in person with the Department if so requested. Failure to appeal within 5 business days after receiving the Department's written notice denying the request constitutes a forfeiture of the bidder's right of appeal. Receipt of appeal is confirmed by email date stamp or certified mail signed by WisDOT staff. A contract will not be executed without documentation that the DBE provisions have been fulfilled.

The Department will appoint a representative who did not participate in the original good faith effort determination, to assess the bidder's appeal. The Department will issue a written decision within 5 business days after the bidder presents all written and oral information. In that written decision, the Department will explain the basis for finding that the bidder did or did not demonstrate an adequate good faith effort to meet the contract DBE goal. The Department's decision is final.

5. Determining DBE Eligibility

Directory of DBE firms

- a. The only resource for DBE firms certified in the State of Wisconsin is the Wisconsin Unified Certification Program (UCP) DBE Directory. WisDOT maintains a current list of certified DBE firms at: <http://wisconsindot.gov/Documents/doing-bus/civil-rights/dbe/dbe-ucp-directory.xlsx>
- b. The DBE Program office is available to assist with contracting DBE firms:(608) 267-3849.
- c. DBE firms are certified based on various factors including the federal standards from the Small Business Administration that assigns a North American Industrial Classification (NAICS) Codes. DBE firms are only eligible for credit when performing work in their assigned NAICS code(s). If a DBE subcontractor performs work that is not with its assigned NAICS code, the prime contractor should contact the DBE Office to inquire about compatibility with the Business Development Program.

6. Counting DBE Participation

Assessing DBE Work

The Department will only count the DBE usage towards the contract DBE goal if the DBE firm is certified as a DBE by one of the UCP agencies. The Department only counts the value of the work a DBE actually performs towards the DBE goal. The Department assesses the DBE work as follows:

- a. The Department counts work performed by the DBE firm's own resources. The Department includes the cost of materials and supplies the DBE firm obtains for the work. The Department also includes the cost of equipment the DBE firm leases for the work. The Department will not include the cost of materials, supplies, or equipment the DBE firm purchases or leases from the prime contractor or its affiliate, with the exception of non-project specific leases the DBE has in place before the work is advertised.
- b. The Department counts fees and commissions the DBE subcontractor charges for providing bona fide professional, technical, consultant, or managerial services. The Department also counts fees and commissions the DBE charges for providing bonds or insurance. The Department will only count costs the program engineer deems reasonable based on experience or prevailing market rates.
- c. If a DBE firm subcontracts work, the Department counts the value of the work subcontracted to a DBE subcontractor.
- d. The contractor will maintain records and may be required to furnish periodic reports documenting its performance under this item.
- e. It is the Prime Contractor's responsibility to determine whether the work that is committed and/or contracted to a DBE firm can be counted for DBE credit by referencing the work type and NAICS code listed for the DBE firm on the Wisconsin UCP DBE Directory.

- f. It is the Prime Contractor's responsibility to assess the DBE firm's ability to perform the work for which it is committing/contracting the DBE to do. Note that the Department encourages the Prime Contractor to assist and develop DBE firms to become fully knowledgeable contractors to successfully perform on its contracts.
- g. The Prime Contractor will inform the DBE office via email of all DBE subcontractors added to the project following execution of the contract. The Prime Contractor may omit submission of another form DT1506, but must submit signed Attachment A forms for additional DBE firms.
- h. See Section 7 for DBE credit evaluation for Trucking and Section 8 for DBE credit evaluation for Manufacturers, Suppliers, and Brokers

Naming conventions: When emailing files, please use the following language to identify your submission- "Project #, Proposal #, Let date, Business Name, Attachment A" Email: DBE_Alert@dot.wi.gov

*Note: A sublet request is required for DBE work, regardless of subcontract tier, and also for reporting materials or supplies furnished by a DBE.

- Sublet Requests via form DT1925 or WS1925 are required for 1st Tier DBEs
- For all 2nd Tier and below notification of DBE sublet is indicated by the contractor entering them in CRCS

7. Credit Evaluation for Trucking

All bidders are expected to adhere to the Department's current trucking policy posted on the HCCI website at: <http://wisconsin.gov/Documents/doing-bus/civil-rights/dbe/trucking-utilization-policy.pdf>

The prime contractor is responsible for ensuring that all subcontractors including trucking firms, receive Form FHWA 1273: <https://www.fhwa.dot.gov/programadmin/contracts/1273/1273.pdf>

See Section 8 for Broker credit.

8. Credit Evaluation for Manufacturers, Suppliers, Brokers

The Department will calculate the amount of DBE credit awarded to a prime using a DBE firm for the provisions of materials and supplies on a contract-by-contract basis. The Department will count the material and supplies that a DBE firm provides under the contract for DBE credit based on whether the DBE firm is a manufacturer, supplier, or broker. Generally, DBE credit is determined through evaluation of the DBE owner's role, responsibility, and contribution to the transaction. Maximum DBE credit is awarded when the DBE firm manufactures materials or supplies. DBE credit decreases when the DBE firm solely supplies materials, and minimal credit is allotted when the DBE firm's role is administrative or transactional. It is the bidder's responsibility to confirm that the DBE firm is considered a supplier or a manufacturer before listing them on Commitment to Subcontract to DBE form DT1506 or DBE Commitment submitted with the bid.

a. Manufacturers

- (1) A manufacturer is a firm that operates or maintains a factory or establishment that produces, on the premises, the materials, supplies, articles, or equipment required under the contract and of the general character described by the specifications.
- (2) If the materials or supplies are obtained from a DBE manufacturer, **100%** percent of the cost of the materials or supplies counts toward DBE goals.

b. Regular Dealers of Material and/or Supplies

- (1) A regular dealer is a firm that owns, operates, or maintains a store, warehouse, or other establishment in which the materials, supplies, articles or equipment of the general character described by the specifications

and required under the contract are bought, kept in stock, and regularly sold or leased to the public in the usual course of business.

- (2) If the materials or supplies are purchased from a DBE regular dealer, count **60%** percent of the cost of the materials or supplies toward DBE goals.
- (3) At a minimum, a regular dealer must meet the following criteria to be counted for DBE credit:
 - i. The DBE firm must be an established, regular business that engages, as its principal business and under its own name, in the purchase and sale or lease of the products in question.
 - ii. The DBE firm must both own and operate distribution equipment for the product--bulk items such as petroleum products, steel, cement, gravel, stone, or asphalt. If some of the distribution equipment is leased, the lease agreement must accompany the DBE Commitment form for evaluation of the dealer's control before the DBE office approves the DBE credit.
- (4) When DBE suppliers are contracted, additional documentation must accompany the DBE Commitment and Attachment A forms. An invoice or bill-of-sale that includes names of the bidder and the DBE supplier, along with documentation of the calculations used as the basis for the purchase agreement, subcontract, or invoice. WisDOT recognizes that the amount on the Attachment A form may be more or less than the amount on the invoice per b.(1) above.
 - i. The bidder should respond to the following questions and include with submission of form DT1506 or the DBE Commitment entered with bid:
 - a. What is the product or material?
 - b. Is this item in the prime's inventory or was the item purchased when contract was awarded?
 - c. Which contract line items were referenced to develop this quote?
 - d. What is the amount of material or product used on the project?
- (5) Supplies purchased in **bulk** from DBE firms at the beginning of the season may be credited to current contracts if submitted with appropriate documentation to the DBE office.
 - i. To ensure that the appropriate credit is assigned, follow the procedure below:
 - a. When DBE suppliers are contracted for bulk supply or commodity purchases, an invoice or bill-of-sale that includes names of the contractor and the DBE supplier should be submitted to the DBE Office via eSubmit (preferred during letting) or the DBE_Alert email box. The supply/commodity credit may be applied during the federal fiscal year (October- September) in which the purchase was made.
 - b. When the contractor intends to apply the credit to a particular project, submit a copy of the original invoice, documentation of the calculations for supplies/commodities to be used on the project, and an Attachment A. Indicate on the Attachment A:
 - c. This supply/commodity is in the prime's inventory or pre-paid in case of commodities
 - d. The full value of the original invoice submitted to the DBE Office, above in (1)
 - e. The amount of material or product used on this project
 - f. Fuel estimate listed on Attachment A will be recorded as a deduction from the full fuel purchase amount shown on the invoice
 - ii. DBE Office Process (Applies only to bulk purchases)
 - a. Supply/Commodity commitment is received
 - b. Engineer verifies amount listed on invoice and enters the full amount into spreadsheet
 - c. The amount of credit applied for each project is updated on the spreadsheet until the bulk purchase is exhausted
 - d. Engineer informs contractor when full amount of bulk purchase has been applied

c. Brokers, Transaction Expeditors, Packagers, Manufacturers' Representatives

- (1) No portion of the cost of the materials, supplies, services themselves will count for DBE credit. However, WisDOT will evaluate the fees or commissions charged when a prime purchases materials, supplies, or services from a DBE certified firm which is neither a manufacturer nor a regular dealer, namely: brokers, packagers, manufacturers' representatives, or other persons who arrange or expedite transactions.
- (2) Brokerage fees are calculated as **10%** of the purchase amount.
- (3) WisDOT may count the amount of fees or commissions charged for assistance in the procurement of the materials and supplies, fees, or transportation charges for the delivery of materials or supplies required on a job site.
- (4) Evaluation of DBE credit includes review of the contract need for the item/service, the sub-contract or invoice for the item/service, and a comparison of the fees customarily allowed for similar services to determine whether they are reasonable.

9. DBE Commitment Modification Policy (Formerly "DBE Replacement Policy")

a. Issuing a Contract Change Order

Any changes or modifications to the contract once executed are considered contract modifications and as such require a change order. In addition, the DBE office must provide consent for reduction, termination, or replacement of subcontractors approved on the DBE Commitment *in advance* of the modification for the prime contractor to receive payment for work or supplies. Additions to the DBE Commitment do not require advance notification of the DBE office. (see below e. DBE Utilization beyond the approved DBE Commitment)

b. Contractor Considerations

- (1) A prime contractor cannot modify the DBE Commitment through reduction in participation, termination, or replacement of a DBE subcontractor listed on the approved DBE Commitment without prior written consent from the DBE Office. This includes, but is not limited to, instances in which a prime contractor seeks to perform work originally designated for a DBE subcontractor with its own forces or those of an affiliate, a non-DBE firm, or with another DBE firm.
- (2) If a prime contractor reduces participation, replaces, or terminates a DBE subcontractor who has been approved for DBE credit toward its contract, the prime is required to provide documentation supporting its inability to fulfill the contractual commitment made to the Department regarding the DBE utilization.
- (3) The Prime Contractor is required to demonstrate efforts to find another DBE subcontractor to perform at least the same amount of work under the contract as the DBE subcontractor that was terminated, to the extent needed to meet the assigned DBE contract goal. When additional opportunity is available by contract modifications, the Prime Contractor must utilize DBE subcontractors that were committed to equal work items, in the original contract.
- (4) In circumstances when a DBE subcontractor fails to complete its work on the contract for any reason, or is terminated from a contract, the Prime Contractor must undertake efforts to maintain its commitment to the assigned DBE goal.
- (5) The DBE subcontractor should communicate with the Prime Contractor regarding its schedule and capacity in the context of the contract. If the DBE firm anticipates that it cannot fulfill its subcontract, they will advise the Prime Contractor and suggest a DBE subcontractor that may replace their services and provide written consent to be released from its subcontract.
 - i. Before the Prime Contractor can request modification to the approved DBE Commitment, the Prime Contractor must:
 - a. Make every effort to fulfill the DBE Commitment by working with the listed DBE subcontractor to ensure that the firm is fully knowledgeable of the Prime Contractor's expectations for successful performance on the contract. Document these efforts in writing.

- b. If those efforts fail, provide written notice to the DBE subcontractor of the Prime Contractor's intent to request to modify the Commitment through reduction in participation, termination, and/or replacement of the subcontractor including the reason(s) for pursuing this action.
- c. Copy the DBE Office on all correspondence related to changing a DBE subcontractor who has been approved for DBE credit on a contract, including preparation and coordination efforts.
- d. Clearly state the amount of time the DBE firm has to remedy and/or respond to the notice of intent to replace/terminate. The DBE must be allowed five days from the date notice was received as indicated by email time stamp or signed certified mail, to respond, in writing. EXCEPTION: The Prime Contractor must provide a verifiable reason for a response period shorter than five days. For example, a WisDOT project engineer or project manager confirms that WisDOT has eliminated an item the DBE subcontractor was contracted for.
- e. The DBE subcontractor must acknowledge the contract modification with written response to the Prime Contractor and the DBE Office. If objecting to the subcontract modification, the DBE subcontractor must outline the basis for objection to the proposed modification, providing sound reasoning for WisDOT to reject the prime's request.

c. Request to Modify DBE Subcontracting Commitment

The written request referenced above may be delivered by email or fax. The request must contain the following:

- (1) Project ID number
- (2) WisDOT Contract Project Engineer's name and contact information
- (3) DBE subcontractor name and work type and/or NAICS code
- (4) Contract's progress schedule
- (5) Reason(s) for requesting that the DBE subcontractor be replaced or terminated
- (6) Attach/include all communication with the DBE subcontractor to deploy/address/resolve work completion

Naming conventions: When emailing files, please use the following language to identify your submission- "Project #, Proposal #, Let date, Business Name, MODIFICATION" Email: DBE_Alert@dot.wi.gov + Project Engineer

WisDOT will review the request and any supporting documentation submitted to evaluate if the circumstance and the reasons constitute good cause for replacing or terminating the approved DBE subcontractor.

Good Causes to Replace a DBE subcontractor according to the federal DBE program guidelines {49 CFR part 26.53}

- The listed DBE subcontractor fails or refuses to execute a written contract
- The listed DBE subcontractor fails or refuses to perform the work of its subcontract in a way consistent with normal industry standards. Provided, however, that good cause does not exist if the failure or refusal of the DBE subcontractor to perform its work on the subcontract results from the bad faith or discriminatory action of the prime contractor
- The listed DBE subcontractor fails or refuses to meet the prime contractor's reasonable, nondiscriminatory bond requirements
- The listed DBE subcontractor becomes bankrupt, insolvent, or exhibits credit unworthiness
- The listed DBE subcontractor is ineligible to work on public works projects because of suspension and debarment proceedings pursuant 2 CFR Parts 180, 215, and 1,200 or applicable state law
- The prime has determined that the listed DBE subcontractor is not a responsible contractor
- The listed DBE subcontractor voluntarily withdraws from the project and provides written notice of its withdrawal
- The listed DBE subcontractor is ineligible to receive DBE credit for the type of work required

- A DBE firm owner dies or becomes disabled with the result that the listed DBE subcontractor is unable to complete its work on the contract.

d. Evaluation and Response to the Request

WisDOT's timely response to the Prime Contractor's request for modification of the approved DBE Commitment will be provided to the prime and the WisDOT project engineer via email.

If WisDOT determines that the Prime Contractor's basis for reduction in participation, replacement, or termination of the DBE subcontractor is not consistent with the good cause guidelines, the DBE office will provide a response via email within 48-hours of receipt of request from the Prime Contractor as indicated by email time stamp. The communication will include: the requirement to utilize the committed DBE, actions to support the completion of the contractual commitment, a list of available WisDOT support services, and administrative remedies, including withholding payment to the prime, that may be invoked for failure to comply with federal DBE guidelines for DBE replacement.

The WisDOT contact for all actions related to modification of the approved DBE Commitment is the DBE Program Engineer who can be reached at DBE_Alert@dot.wi.gov or (414) 335-0413.

e. DBE Utilization beyond the approved DBE Commitment

When the prime or a subcontractor increases the scope of work for an approved DBE subcontractor or adds a DBE subcontractor who was not on the approved form DT1506 or DBE Commitment submitted with bid at any time after contract execution, this is referred to as voluntary DBE contract goal achievement. The contractor must follow these steps to ensure that the participation is accurately credited toward the DBE goal:

- (1) Forward a complete, signed Attachment A form to the DBE Office. A complete Attachment A includes DBE subcontractor contact information, signatures, subcontract value, and description of the work areas to be performed by the DBE. The DBE Office will verify the DBE participation and revise the DBE Commitment based on the email/discussion and the new Attachment A.
- (2) When adding to an existing DBE Commitment, submit a new Attachment A to the DBE Alert mailbox
- (3) OR Submit a final Attachment A to DBE Alert during the Finals Process when Compliance receives notice of "Substantially Complete"

Naming conventions: When emailing files, please use the following language to identify your submission- "Project #, Proposal #, Let date, Business Name, New Attachment A" Email: DBE_Alert@dot.wi.gov

Special note on trucking

- DBE truckers added to the sublets in CRCS *will* be approved without DBE credit (You will see a "N" in CRCS instead of "Y")
- Prime Contractors may enter a "place holder" e.g. \$1000.00, for DBE Trucking in CRCS if the full amount of trucking is unknown for sublet purposes only
- The hiring contractor may obtain the Attachment A with DBE signature included but the **Prime Contractor** must sign the Attachment A before submitting
- DBE truckers need to be added to the DBE commitment once. If the DBE trucker is on the initial commitment (DT1506/E1506) there is no requirement to submit another Attachment A for that trucker for that contract.

10. Commercially Useful Function

- a. Commercially Useful Function (CUF) is evaluated after the contract has been executed, while the DBE certified firm is performing contracted work items.
- b. The Department uses Form DT1011, DBE Commercially Useful Function Review and Certification to evaluate if the DBE is performing a commercially useful function. WisDOT counts expenditures of a DBE toward the DBE goal only if the DBE is performing a commercially useful function on that contract.

- c. A DBE firm is performing a commercially useful function if the following conditions are met:
 - (1) For contract work, the DBE is responsible for executing a distinct portion of the work and is carrying out its responsibilities by actually performing, managing, and supervising that work.
 - (2) For materials and supplies, the DBE is responsible for negotiating price, determining quality and quantity, ordering, and paying for those materials and supplies.
- d. Offsite Hauling – when DBE truck will haul between a pit and plant or location other than the construction site associated with the commitment
 - (1) Indicate Offsite Hauling on Attachment A
 - (2) Discuss offsite hauling at weekly progress meetings with Project Engineer (PE)
 - (3) PE conducts spot checks of pits/plants to verify DBE truck is hauling and/or verifying hauling log
 - (4) Prime should be prepared to submit haul tickets, plant/pit tickets, timecards, and other pertinent documentation if requested by PE or DBE Office

11. Credit Evaluation for DBE Primes

WisDOT calculates DBE credit based on the amount and type of work performed by DBE certified firms for work submitted with required documentation. If the prime contractor is a DBE certified firm, the Department will only count the work that the DBE prime performs with its own forces for DBE neutral credit. The Department will also calculate DBE credit for work performed by any other DBE certified subcontractor, DBE certified supplier, and DBE certified manufacturer on the contract in each firm's approved NAICS code/work areas that are submitted with required documentation. Crediting for manufacturers and suppliers is calculated consistent with Section 8 of this document and 49 CFR Part 26.

12. Joint Venture

A joint venture is an association of a DBE firm and one or more other firms to carry out a single, for-profit business enterprise, for which the parties combine their property, capital, efforts, skills and knowledge, and in which the DBE is responsible for a distinct, clearly defined portion of the work of the contract and whose share in the capital contribution, control, management, risks, and profits of the joint venture are commensurate with its ownership interest. If a DBE performs as a participant in a joint venture, the Department will only credit the portion of the total dollar value of the contract equal to the portion of the work that the DBE performs with its own forces.

13. Mentor-Protégé

- a. If a DBE performs as a participant in a mentor-protégé agreement, the Department will credit the portion of the work performed by the DBE protégé firm.
- b. DBE credit is evaluated and confirmed by the DBE Office for any contracts on which the mentor-protégé team identifies itself to the DBE Office as a current participant of the Mentor-Protégé Program.
 - (1) DBE credit may only be awarded to a non-DBE mentor firm for using its own protégé firm for less than one half of its goal on any contract; and
 - (2) Not award DBE credit to a non-DBE mentor firm for using its own protégé firm for more than every other contract performed by the protégé firm.
- c. A DBE protégé firm may be eligible for conditional NAICS code extension for training with the mentor. Request permission from the DBE Office- Certification area.
- d. Refer to WisDOT's Mentor-Protégé guidelines for guidance on the number of contracts and amount of DBE credit allowed on WisDOT projects.

14. Use of Joint Checks

The use of joint checks is allowable if it is a commonly recognized business practice in the material industry. A joint check is defined as a two-party check between a DBE subcontractor, a prime contractor, and the regular dealer or materials supplier who is neither the prime nor an affiliate of the prime. Typically, the prime contractor issues one check as payor to the DBE subcontractor and to the supplier jointly (to guarantee payment to the supplier) as payment for the material/supplies used by the DBE firm in cases where the DBE subcontractor and materials have been approved for DBE credit. The DBE subcontractor gains the opportunity to establish a direct contracting relationship with the supplier to potentially facilitate a business rapport that results in a line of credit or increased partnering opportunities.

The cost of material and supplies purchased by the DBE firm is part of the value of work performed by the DBE to be counted toward the goal. To receive credit, the DBE firm must be responsible for negotiating price, determining quality and quantity, ordering the materials, and installing (where applicable) and "paying for the material itself." See 49 CFR 26.55(c)(1).

The approval to use joint checks constitutes a commitment to provide further information to WisDOT, upon request by staff. WisDOT will allow the use of joint checks when the following conditions are met:

- a. The Prime Contractor must request permission to use joint checks from the DBE Office by submitting the Application to Use Joint Checks.
 - (1) Request should be made when the DBE Commitment or the Request to Sublet is submitted; the request will not be considered if submitted after the DBE Subcontractor starts its work.
 - (2) Approval/Permission must be granted prior to the issuance of any joint checks.
 - (3) The payment schedule for the supplier must be presented to the DBE office before the first check is issued.
 - (4) The joint check for supplies must be strictly for the cost of approved supplies.
- b. The DBE subcontractor is responsible for furnishing and/or installing the material/work item and is not an 'extra participant' in the transaction. The DBE firm's role in the transaction cannot be limited solely to signing the check(s) to release payment to the material supplier. At a minimum, the DBE subcontractor's tasks should include the following:
 - (1) The DBE subcontractor (not the prime/payor) negotiates the quantities, price, and delivery of materials.
 - (2) The DBE subcontractor consents to sign/release the check to the supplier by signing the [Application to Use Joint Checks](#) after establishing the conditions and documentation of payment within the subcontract terms or in a separate written document.
- c. The Prime contractor/payor acts solely as a guarantor.
 - (1) The Prime Contractor agrees to furnish the check used for the payment of materials/supplies under the contract.
 - (2) The prime contractor/payor cannot require the subcontractor to use a specific supplier or the prime contractor's negotiated unit price.

15. Payment

Costs for conforming to this Additional Special Provision (ASP) and any associated DBE requirements are incidental to the contract.

Appendix A

Substantive Conversation Guidelines

The substantive conversation is critical to all bidders' demonstration of good faith effort to meet the DBE goal prior to bid opening. Relationship building between primes and subcontractors is crucial to DBE goal attainment. Responsible bidders seek to build rapport with potential DBE subcontractors to understand capacity, areas of expertise, and assess contracting feasibility. Bidders who compete for WisDOT contracts are specialty contractors responding to a growing and changing contract environment. Just as these specialists are responsible for care of the roads, they are likewise responsible for contributing to the health of the industry. The substantive conversation drives collaboration that will build industry health and capacity. The following is intended to provide guidance for such discussions but is not an exhaustive list. Contractors are encouraged to incorporate their existing strategies for cultivating business relationships as well.

Prior to Bid Opening- this discussion should happen as early as possible (WisDOT advertisements are released weeks prior to each Let)

1. Determine DBE subcontractor's interest in quoting
2. If response indicates inexperience with quoting- offer support/assistance to the DBE in understanding the industry including fundamentals a subcontractor needs to know, required reading and/or resources.
3. Assess their interest and experience in the road construction industry by asking questions such as:
 - Have you competed for other WisDOT contracts? Ratio of competed/to wins
 - Have you performed on any transportation industry contracts (locally or with other states)?
 - What the largest contract you've completed?
 - Have you worked in the industry: apprentice, journeyman, safety, inspection etc.?
 - Does this project fit into your schedule? Are you working on any contracts now?
 - Have you reviewed a copy of the plans? Are you comfortable performing within the scope and quantity considerations of this contract?
 - What region do you work in? Home base?
 - Which line items are you considering?
 - Have you read/are you familiar with WisDOT Standard Specifications? Construction Material Manual?
 - Do you understand where your work fits in the project schedule, project phases?

Following Bid Opening- this discussion can happen at any time

1. After reviewing their quote, note the following in your discussion:
 - Does the quote look complete? Irregular?
 - Are there errors in the quote? Are items very high or very low?
 - In general, does the quote look competitive?
2. Questions and Advice for the bidder to share with the potential DBE subcontractor:
 - What line items would typically be in a competitive quote for a subcontractor of their specialty?
 - How many employees and what is their role/experience/expertise in your firm?
 - Do you have resources for labor (union member, family-based, community-resourced) and capital (banking relationship, bond agent, CPA)?
 - Where have you worked: cities, states, government, commercial, residential/private sector, etc. Explain similarities or differences.
 - Refer them to reliable, trusted, industry resources that can educate or connect them to relevant resources, education/certification resources, more appropriate contract opportunities.
 - Discussion about prime contract and subcontract liability, critical path items, contract quantities, schedule risks, and potential profit/loss (for upcoming known projects or in general).
 - Discussion of bonding, insurance, and overall business risk considerations.

Appendix B

Sample Contractor Solicitation Letter Page 1

(This sample is provided as a guide, not a formatting requirement)

DBE Solicitation - [Month] [Day], [Year] WisDOT Bid Letting

Attention all DBEs. [Prime Contractor] is actively seeking your quote for the [Month][Day], [Year] Bid Letting. [Prime Contractor] is considering bidding on the projects listed on page 2 as a prime contractor. Please see page 2 for instructions and the sub-contractable opportunities for each proposal.

Does [Prime Contractor] accept quotes in areas we might self-perform? Yes, we do! We support this federal rule and (if needed) we consider areas we might self-perform an opportunity to provide in the field assistance and training if we award your quote.

Where can DBEs find the plans, specifications & addenda? Please visit [Prime Contractor's] plan room [LINK] or on WisDOT's Highway Construction Contract Information HCCI website: [Wisconsin Department of Transportation Highway Construction Contract Information \(wisconsindot.gov\)](http://Wisconsin Department of Transportation Highway Construction Contract Information (wisconsindot.gov)). This same website can be checked for the contract status.

What should your quote include? All the costs required to complete the items you propose to perform including labor, equipment, material, and related bonding or insurance. The quote should also note items that you are DBE certified to perform, tied items, and any special terms. Please use page 2 as your cover sheet for your quote.

Do you have a question regarding bonding, credit, insurance, equipment, or supplies/materials? We welcome all DBE questions! Please call [Prime Contractor] and ask to speak with [Contact]. [Prime Contractor] can provide basic information as well as a referral to a trusted industry partner for insurance and bonding needs.

When are quotes due?

[Month] [Day], [Year] at [Time]. We accept quotes via SBN, email, or fax. Please make every effort to have your quotes in by this time or earlier. Quality check your quote so it includes the correct letting date, project ID, proposal number, unit price and extension.

Who can DBEs contact for questions, information, clarification or for a quote evaluation? [Project Manager Name] [Phone] [Email]. If you are quoting [Prime Contractor] for the first time, we encourage you to come meet with us in person to discuss the project. Our office hours are 7:30 a.m. – 5:00 p.m. On bid day, we are in the office by 6:30 a.m.

Why partner with [Prime Contractor]?

DBE partnership is a core part of [Prime Contractor's] mission. Including DBEs at the beginning of each project is essential in the success of each project. We consider DBEs to be important industry partners who bring dedication and knowledge at various stages during construction. We are proud to be an industry leader with our DBE partnership. Your success as a DBE is our success.

Sample Contractor Solicitation Letter Page 2
(This sample is provided as a guide, not a formatting requirement)
 REQUEST FOR QUOTE

[Prime Contractor]
Letting Date: [Month] [Day], [Year]
Project IDs: 1234-56-00 (Proposal #1) & 1234-01-78 (Proposal #6)

Please check all that apply:

- Yes, we will be quoting the projects & items listed below
- No, we are not interested in quoting on the letting or its items referenced below
- Please take our name off your monthly DBE contact list
- We have questions about quoting this letting. Please have someone contact me at this number:

Prime Contractor Contact: _____ DBE: _____
 Phone: _____ Fax: _____
 Email: _____

Please circle the proposals and items you will be quoting below and contact us with any questions

Proposal County	1 Dane County	6 Crawford County
Clearing & Grubbing	X	X
Dump Truck Hauling	X	X
Curb/Gutter/Sidewalk	X	
Erosion Control Items		X
Excavation	X	X
Pavement Marking		X
Traffic Control	X	
Sawing	X	X
QMP, Base		X
Pipe Underdrain	X	
Landscape		X
Beam Guard	X	
Electrical	X	
Signs/Posts/Markers		X
Survey/Staking		X

Again, please make every effort to have your quotes into our office by time deadline prior to the letting date.

Sample Contractor Solicitation Email - Simplified
(This sample is provided as a guide, not a formatting requirement)

ATTENTION DBEs

- **[Prime Contractor] specializes in municipal projects in the XX Region(s)**
- **We have successfully competed for and completed XX WisDOT projects over the past XX years**
- **Consider [Prime Contractor] your partner on WisDOT Projects**

[Prime Contractor] is seeking your subcontractor quote for the XX/XX/20XX WisDOT bid letting on the below projects:

Project	Proposal	County	Region
1234-56-00	2	Dane	SW
1234-01-78	6	Crawford	SW

- Please review the attachments **[attach Solicitation Letter]** and respond with your intent to quote (or not) along with the work items you are interested in performing and respond via fax or email by **date**. The quote should note items that you are DBE certified to perform, tied items, and any special terms. Please include labor, equipment, material, and related bonding or insurance.
- If you have any questions regarding bonding, credit, insurance, equipment and/or materials/supplies, please feel free to call [Prime Contractor] and ask for [Contact]. **(Include if your company is willing to answer these types of DBE questions)**
- Plans and Specifications can be found: **WisDOT HCCI Website: List webpage where plans are located**
- If you do choose to quote, please make every effort to have your quote into our office by **time and date**. Make sure the correct letting date, project number, unit price and extension are included in your quote.
- Should you have questions regarding the mentioned project, please call our office at (414) 555-5555 and we will direct you to the correct estimator/project manager.
Our office hours are 7:30 a.m. - 5:00 p.m.

Thank you – we look forward to working with your company on this project!

Prime Contractor
Project Manager
 Direct: 414-555-5555
 Cell: 414-555-5556

Sample Contractor Solicitation Email to **non-DBE** WisDOT Subcontractors - Simplified

(This sample is provided as a guide, not a formatting requirement)

ATTENTION WisDOT SUBCONTRACTORS

[Prime Contractor] is considering bidding on the below projects for the **XX/XX/20XX WisDOT Bid Letting**:

Project	Proposal	County	Region	DBE Goal
1234-56-00	2	Dodge	SW	6.00%
1234-01-78	11	Adams	NC	3.00%
1234-00-99	20	Buffalo	NW	5.00%
1234-00-98	33	Portage	NC	6.00%

The above projects have DBE goals and [Prime Contractor] is committed to DBE inclusion with every project. As such, we are requesting:

- All WisDOT Subcontractors to **solicit and utilize** DBEs in your quotes.
- DBE participation can be achieved through purchasing materials from DBE suppliers, using DBE subcontractors and/or DBE trucking firms or any combination of these.
- If there is an opportunity to untie an item in your quote so a DBE can be utilized, please look for those opportunities as well.
- Your quote will be evaluated based on the amount of DBE participation your company is able to provide when compared to other quotes for the same work.

If you do choose to quote, please make every effort to have your quote into our office by **time and date**. Please submit all quotes to [Email]. Make sure the correct letting date, project number, unit price and extension are included in your quote.

Should you have questions regarding the mentioned project, the Project Manager contact is: [Name] [Phone Number] [Email]

Thank you for utilizing DBEs who are trusted industry partners with WisDOT projects.

Prime Contractor
 Project Manager
 Direct: 414-555-5555
 Cell: 414-555-5556

Appendix C

Small Business Network (SBN) Overview

The Small Business Network is a part of the Bid Express® service that was created to ensure that prime bidders have a centralized online location to find subs - including small and disadvantaged business enterprises (DBEs). It is available for prime bidders to use as part of their Basic Service subscription. Within the Small Business Network, **Prime Contractors** can:

1. Easily select proposals, work types and items:
 - a. After adding applicable work types, select items that you wish to quote. Enter the sub-quote quantities and add comments, if desired. Adding or removing items and work types can be done quickly. If needed, you can save the sub-quote for later completion.
2. Create sub-quotes for the subcontracting community:
 - a. Create sub-quotes with ease using the intuitive sub-quote creator. In seven short steps, you can rapidly create a custom sub-quote directed to all subcontractors that bid on the applicable work types. Steps include: provide contact information and sub-quote expiration date, select letting and proposal, add work types and items, specify terms and conditions, upload attachments, and select vendors.
 - b. Create a sub-quote to send to subcontractors or suppliers that lists the items in a proposal that you want quoted
 - c. Create an unlimited number of sub-quotes for items you want quoted, and optionally mark them as a DBE preferred request.
 - d. Add attachments to sub-quotes.
3. View sub-quote requests & responses:
 - a. After logging into the Bid Express service, you can quickly review all of your sub-quote requests and all unsolicited sub-quote requests from subcontractors. To simplify the Small Business Network home screen, sub-quote requests can be hidden with one click if they are not applicable.
 - b. View or receive unsolicited sub-quotes that subcontractors have posted, complete with terms, conditions and pricing.
4. View Record of Subcontractor Outreach Effort:
 - a. For each sub-quote produced, a *Record of Subcontractor Outreach Effort* is generated that shows the response statistics for a particular sub-quote. If accepted by the letting agency, this report may serve as proof of a "Good Faith" effort in reaching out to the DBE community.
 - b. Easily locate pre-qualified and certified small and disadvantaged businesses.
 - c. Advertise to small and disadvantaged businesses more efficiently and cost effectively.
 - d. Document your interactions with subs/DBEs by producing an Outreach Report (may be accepted as proof of DBE outreach at the discretion of each agency).

The Small Business Network help small businesses learn more about opportunities, compete more effectively, network with other contractors and subcontractors, and win more jobs. The DBE will provide free SBN accounts to DBEs when requested. Use DBE_Alert@dot.wi.gov to request an account. **DBE firms can:**

1. View and reply to sub-quote requests from primes:
 - a. After logging into the Bid Express service, you can quickly review all incoming sub-quote requests and all unsolicited sub-quotes created by your company. Receive notifications by selected work type. To simplify on the Small Business Network home screen, sub-quote requests can be filtered by work types relevant to your interests or hidden with one click if they are not applicable.
2. Select items when responding to sub-quote requests from primes:
 - a. You have the freedom to choose and price any number of items when responding to a sub-quote request. Quantities can be modified, and per-item comments are also available.
 - b. View requests for sub-quotes for work that primes have posted for projects they are bidding, add your pricing, terms, and conditions, and submit completed sub-quotes to the requesting primes. c. Add attachments to a sub-quote.
3. Create and send unsolicited sub-quotes to specific contractors:
 - a. Create unsolicited sub-quotes with ease using the intuitive sub-quote creator. In eight short steps, you can rapidly create a custom sub-quote directed at any number of specific vendors of your choosing. Steps include: provide contact information and sub-quote expiration date, select letting and proposal, add work types and items, specify terms and conditions, upload attachments, and select vendors.
4. Easily select and price items for unsolicited sub-quotes:
 - a. After adding applicable work types, select items that you wish to quote. The extended price calculates automatically, cutting out costly calculation errors. Comments can be provided on a per-item basis as well.
 - b. Create an unsolicited sub-quote that lists the items from a proposal that you want to quote, include pricing, terms and conditions, and send it to selected prime/plan holder.
 - c. Add attachments to a sub-quote.
 - d. Add unsolicited work items to sub-quotes that you are responding to.
5. Easy Access to Valuable Information
 - a. Receive a confirmation that your sub-quote was opened by a prime.
 - b. View Bid Tab Analysis data from past bids, including the high, average and low prices of items.
 - c. View important notices and publications from DOT targeted to small and disadvantaged businesses.
6. Accessing Small Business Network for WisDOT contracting opportunities
 - a. If you are a contractor not yet subscribing to the Bid Express service, go to www.bidx.com and select "Order Bid Express." The Small Business Network is a part of the Bid Express Basic Service.

Appendix D

Good Faith Effort Evaluation Measures *by categories referenced in DBE regulations*

Bidders must demonstrate that they took all necessary and reasonable steps to achieve the assigned DBE contract goal. For each contract, all bidders must submit documentation indicating the goal has been met or if falling short of meeting the assigned goal, must request a DBE Goal Waiver and document all efforts employed to secure DBE subcontractor participation on Form DT1202.

DBE staff analyze the bidder's documented good faith efforts to determine if action taken was sufficient to meet the goal. Sufficiency is measured contract-by-contract. WisDOT evaluates active and aggressive efforts, quality, quantity, scope, intensity, and appropriateness of the bidder's efforts as a scale of the principles of Good Faith outlined in 49 CFR Part 26, Appendix A. Additional emphasis is placed on the bidder's demonstration of timely submission of documentation and communication with DBE subcontractors, and business development initiatives undertaken to support DBE firm growth.

The following is a sample of good faith effort activities that are rated according to the accompanying rubric. Contractors are encouraged to identify additional activities that align with their business type(s).

- Personal, tailored solicitation to firms that specialize in work types planned or desired for subcontracting
- Follow up to initial solicitation via email or phone
- Substantive conversation including topics such as contract liability, critical path work items, schedule risks, and potential profit/loss
- SBN utilization including posting quotes
- Review and response to DBE quotes including provision of information about plans, specifications, and requirements as applicable
- Documentation requesting subcontractors support DBE goal by solicitation and inclusion of DBE subcontractor quotes
- Responsive and timely submission of organized documentation
- Analysis of number of DBE firms who do work types that you typically subcontract
- Analysis of number of DBE firms who reside in geographical areas where prime seeks work
- Analysis of firms who express interest in bidding/quoting including the number of firms who declined your solicitation
- Reference check of DBE subcontractor work or training (documentation of questions and response required)
- Number of different efforts undertaken to meet the assigned DBE goal as documented in accompanying Form DT1202
- Submission of all DBE quotes received matched with a variety of work to be performed by DBEs
- Number and names of DBE firms provided written advice, or referral to industry-specific business development resources
- Overall pattern of DBE utilization on all WisDOT contracts which may include contracting with municipalities
- Documentation of resources expended to meet assigned DBE goal (#of hours, staff titles, average pay rate, actions taken)
- Analysis of subcontractable work items to be completed by prime beyond prime contractor's 30%
- Risk analysis of work items that are typically in tied quotes that could be unbundled
- List of contract work items in smallest economically feasible units, identifying schedule impact
- Submission of a Gap Analysis identifying DBE skillset and/or industry needs
- Staff training in EEO and Civil Rights laws as documented in training logs
- Written Capacity Assessment completed with DBE firm documenting its ability to perform the work quoted
- DBE engagement efforts beyond simple solicitation that include a substantive discussion, initiated as early in the acquisition process as possible (*points added for each day prior to letting*)
- Outreach and marketing efforts with minority, women, and veteran-focused organizations at least 10 days prior to bid opening
- Active involvement in WisDOT's Business Development Program, TrANS training, facilitated networking efforts, workshops
- Customized teaching/training efforts for future opportunities with DBE subcontractor, contract specific and/or annually
- Introduction and reference provided for DBE subcontractor to a prime who has not previously contracted with the DBE firm
- Prime utilization of a DBE subcontractor the prime has not contracted with previously
- Written referral/recommendation to bond/insurance agents, manufacturer, supplier
- Documented efforts fostering DBE participation through administrative and/or technical assistance
- Evidence of negotiation with the DBE firm about current and future Let opportunities
- Recommendation of local and state services that support small business and access to opportunity: DOA, SBA, WEDC, WPI, etc.
- Advice on bonding, lines of credit, or insurance as required to complete the items quoted and contract requirements

GFE Evaluation Rubric – Phase 1 – Initial Review

DT1202	Examples	Rating	OBOEC Feedback
Solicitation Documentation	<p>Identify all reasonable and available activities performed to solicit the interest of all certified DBEs who have capacity and ability to perform work on the project.</p> <p><i>Such as: Updated solicitation letter and email, timely solicitation, and follow-up, and/or utilized various methods to communicate solicitation (ex: letter, email, publication, posting and/or website)</i></p>		
Selected Work Items Documentation	<p>All work items are broken out into economically feasible units to facilitate DBE participation.</p> <p><i>Such as: Selected work items are specific to each proposal and clearly identified in all solicitation(s)</i></p>		
Documentation of Project Information provided to Interested DBEs	<p>Provide interested DBEs with adequate information about the plans, specifications, and any other contractual requirements in a timely manner to assist DBEs in response to solicitation.</p> <p><i>Such as: Project information is clearly identified in all solicitation(s)</i></p>		
Documentation of Negotiation with Interested DBEs	<p>Provide sufficient evidence demonstrating that good faith negotiations took place during the bid letting.</p> <p><i>Such as: Documented attempts with DBEs or on behalf of DBEs to increase DBE participation</i></p>		
Documentation of Sound Reason for Rejecting DBEs	<p>Provide sufficient evidence demonstrating that DBEs are rejected for sound reasons.</p> <p><i>Such as: Detailed and thoughtful analysis that considers both the percentage and dollar difference when rejecting a DBE including past performance, relevant business experience and stability, safety record, business ethic and integrity, technical capacity, and other tangible factors.</i></p>		
Documentation of Assistance to Interested DBEs- bonding, credit, insurance, equipment, supplies/materials	<p>Documented assistance in both solicitation(s) and outreach to DBEs.</p>		
Documentation of Outreach to Minority, Women, and Community organizations and other DBE Business Development Support	<p>Effectively use the services of minority, women, and community organizations as well as contractors' groups, local, state, and federal business assistance offices and organization that provide assistance in recruiting and supporting DBEs, as well participation in activities that support DBE business development.</p> <p><i>Such as: Variety of activities that translate into meaningful DBE participation</i></p>		
Documentation of other GFE activities	<p><i>Such as: Used DT1202 Excel Workbook, Diversity & Inclusion company policy, Mentor-Protégé participant, awarded neutral DBE after bid submission, included company GFE overview/strategy information and/or company website highlights DBE opportunities and participation</i></p>		
Overall Demonstration of GFE			

GFE EVALUATION RATING LEGEND – PHASE 1 – Initial Review

Documentation provided by bidder is evaluated and rated on the rubric. Bidders should include activities characterized by the following types of effort:

ACTIVE & AGGRESSIVE: Demonstrated through engaged and assertive activity

QUALITY: Demonstrated through essential character of conscientious and serious activity

QUANTITY: Demonstrated through a measurable number of activities

SCOPE & INTENSITY: Demonstrated through a rigorous approach to an appropriate and purposeful range of activities

TIMING: Demonstrated through engagement efforts beyond simple solicitation, initiated early in the process

GFE EVALUATION – PHASE 2 – Team Review**GFE Team completes:**

- Review of activities included on the rubric
- Review of the intent to award and sound reasoning submitted by Prime
- Bid analysis to confirm if any bid submitted met the DBE goal
- Review average of other bidders DBE goal achievement
- Team review of combined efforts documented in Phase 1 and 2 constitute final GFE determination

Rating Scale:

- **GFE Approval:**
Bona Fide = 6 or more categories color coded green.
Genuine effort characterized by sincere and earnest activities – “Solicitation” and “Sound Reasoning” must be green
- **GFE Approval:**
Sufficient = 5 or more categories color coded green or yellow
Adequate effort documented with a variety of quality activities – “Solicitation” and “Sound Reasoning” must be green or yellow
- **GFE Denial:**
Pro Forma efforts = 4 or less categories color coded green or yellow. Perfunctory effort characterized by routine or superficial activities

Green = Exceeds expectations

Yellow = Meets expectations

Red = Areas in need of attention and/or absence of documentation

See OBOEC Rubric Analysis Feedback

Excerpt from Appendix A to 49 CFR Part 26:

V. In determining whether a bidder has made good faith efforts, it is essential to scrutinize its documented efforts. At a minimum, you must review the performance of other bidders in meeting the contract goal. For example, when the apparent successful bidder fails to meet the contract goal, but others meet it, you may reasonably raise the question of whether, with additional efforts, the apparent successful bidder could have met the goal. If the apparent successful bidder fails to meet the goal but meets or exceeds the average DBE participation obtained by other bidders, you may view this, in conjunction with other factors, as evidence of the apparent successful bidder having made good faith efforts. As provided in §26.53(b)(2)(vi), you must also require the contractor to submit copies of each DBE and non-DBE subcontractor quote submitted to the bidder when a non-DBE subcontractor was selected over a DBE for work on the contract to review whether DBE prices were substantially higher; and contact the DBEs listed

GFE RUBRIC ANALYSIS	
OBOEC DECISION	APPROVAL OR DENIAL
Prime Contractor	
Proposal	
Project	
Bid Letting	
DBE Goal Amount	
DBE Goal Amount Achieved	
Bid Analysis	
Goal %	Achieved %
Apparent Low Bidder	%
Bidder B	
Bidder C	
Average of OTHER Bidders (Not including Apparent Low Bidder)	
DBE Quotes Received	
DBE Quotes Awarded	
DBE Quote(s) Rejected	Rejected Quote Analysis
DBE Quote(s) Awarded	Awarded DBE Amount

Appendix E

Good Faith Effort Best Practices

This list is not a set of requirements; it is a list of potential strategies

Primes

- Prime contractor open houses inviting DBE firms to see the bid “war room” or providing technical assistance.
- Participate in speed networking and mosaic exercises as arranged by DBE office.
- Host information sessions not directly associated with a bid letting.
- Participate in a formal mentor protégé or joint venture with a DBE firm.
- Participate in WisDOT advisory committees i.e. TRANSAC, or Mega Project committee meetings.
- Facilitate a small group DBE ‘training session’ clarifying how your firm prepares for bid letting, evaluates subcontractors, preferred qualifications, and communication methods.
- Encourage subcontractors to solicit and highlight DBE participation in their quotes to you.
- Quality of communication, not quantity creates the best results. Contractors should be thorough in communicating with DBE firms before the bid and provide any assistance requested to assure best possible bid.

DBE

- DBE firms should contact primes as soon as possible with questions regarding their quotes or bid; seven days prior is optimal.
- Continually check for contract addendums on the HCCI website through the Thursday prior to letting to stay abreast of changes.
- Review the status of contracts on the HCCI website reviewing the ‘apparent low bidder’ list and bid tabs at a minimum.
- Prepare a portfolio or list of related projects and prime and supplier references; be sure to note transportation related projects of similar size and scope, firm expertise and staffing.
- Participate in DBE office assessment programs.
- Participate on advisory and mega-project committees.
- Sign up to receive the DBE Contracting Update.
- Consider membership in relevant industry or contractor organizations.
- Active participation is a must. Quote as many projects as you can reasonably work on; quoting the primes and bidding as a prime with the Department are the only ways to get work.

Appendix F

Good Faith Effort Evaluation Guidance

Appendix A of 49 CFR Part 26

I. When, as a recipient, you establish a contract goal on a DOT-assisted contract for procuring construction, equipment, services, or any other purpose, a bidder must, in order to be responsible and/or responsive, make sufficient good faith efforts to meet the goal. The bidder can meet this requirement in either of two ways. First, the bidder can meet the goal, documenting commitments for participation by DBE firms sufficient for this purpose. Second, even if it doesn't meet the goal, the bidder can document adequate good faith efforts. This means that the bidder must show that it took all necessary and reasonable steps to achieve a DBE goal or other requirement of this part which, by their scope, intensity, and appropriateness to the objective, could reasonably be expected to obtain sufficient DBE participation, even if they were not fully successful.

II. In any situation in which you have established a contract goal, Part 26 requires you to use the good faith efforts mechanism of this part. As a recipient, you have the responsibility to make a fair and reasonable judgment whether a bidder that did not meet the goal made adequate good faith efforts. It is important for you to consider the quality, quantity, and intensity of the different kinds of efforts that the bidder has made, based on the regulations and the guidance in this Appendix.

The efforts employed by the bidder should be those that one could reasonably expect a bidder to take if the bidder were actively and aggressively trying to obtain DBE participation sufficient to meet the DBE contract goal. Mere pro forma efforts are not good faith efforts to meet the DBE contract requirements. We emphasize, however, that your determination concerning the sufficiency of the firm's good faith efforts is a judgment call. Determinations should not be made using quantitative formulas.

III. The Department also strongly cautions you against requiring that a bidder meet a contract goal (i.e., obtain a specified amount of DBE participation) in order to be awarded a contract, even though the bidder makes an adequate good faith efforts showing. This rule specifically prohibits you from ignoring bona fide good faith efforts.

IV. The following is a list of types of actions which you should consider as part of the bidder's good faith efforts to obtain DBE participation. It is not intended to be a mandatory checklist, nor is it intended to be exclusive or exhaustive. Other factors or types of efforts may be relevant in appropriate cases.

A. (1) Conducting market research to identify small business contractors and suppliers and soliciting through all reasonable and available means the interest of all certified DBEs that have the capability to perform the work of the contract. This may include attendance at pre-bid and business matchmaking meetings and events, advertising and/or written notices, posting of Notices of Sources Sought and/or Requests for Proposals, written notices or emails to all DBEs listed in the State's directory of transportation firms that specialize in the areas of work desired (as noted in the DBE directory) and which are located in the area or surrounding areas of the project.

(2) The bidder should solicit this interest as early in the acquisition process as practicable to allow the DBEs to respond to the solicitation and submit a timely offer for the subcontract. The bidder should determine with certainty if the DBEs are interested by taking appropriate steps to follow up initial solicitations.

B. Selecting portions of the work to be performed by DBEs in order to increase the likelihood that the DBE goals will be achieved. This includes, where appropriate, breaking out contract work items into economically feasible units (for example, smaller tasks or quantities) to facilitate DBE participation, even when the prime contractor might otherwise prefer to perform these work items with its own forces. This may include, where possible, establishing flexible timeframes for performance and delivery schedules in a manner that encourages and facilitates DBE participation.

C. Providing interested DBEs with adequate information about the plans, specifications, and requirements of the contract in a timely manner to assist them in responding to a solicitation with their offer for the subcontract.

D. (1) Negotiating in good faith with interested DBEs. It is the bidder's responsibility to make a portion of the work available to DBE subcontractors and suppliers and to select those portions of the work or material needs consistent with the available DBE subcontractors and suppliers, so as to facilitate DBE participation. Evidence of such negotiation includes the names, addresses, and telephone numbers of DBEs that were considered; a description of the information provided regarding the plans and specifications for the work selected for subcontracting; and evidence as to why additional Agreements could not be reached for DBEs to perform the work.

(2) A bidder using good business judgment would consider a number of factors in negotiating with subcontractors, including DBE subcontractors, and would take a firm's price and capabilities as well as contract goals into consideration. However, the fact that there may be some additional costs involved in finding and using DBEs is not in itself sufficient reason for a bidder's failure to meet the contract DBE goal, as long as such costs are reasonable. Also, the ability or desire of a prime contractor to perform the work of a contract with its own organization does not relieve the bidder of the responsibility to make good faith efforts. Prime contractors are not, however, required to accept higher quotes from DBEs if the price difference is excessive or unreasonable.

E. (1) Not rejecting DBEs as being unqualified without sound reasons based on a thorough investigation of their capabilities. The contractor's standing within its industry, membership in specific groups, organizations, or associations and political or social affiliations (for example union vs. non-union status) are not legitimate causes for the rejection or non-solicitation of bids in the contractor's efforts to meet the project goal. Another practice considered an insufficient good faith effort is the rejection of the DBE because its quotation for the work was not the lowest received. However, nothing in this paragraph shall be construed to require the bidder or prime contractor to accept unreasonable quotes in order to satisfy contract goals.

(2) A prime contractor's inability to find a replacement DBE at the original price is not alone sufficient to support a finding that good faith efforts have been made to replace the original DBE. The fact that the contractor has the ability and/or desire to perform the contract work with its own forces does not relieve the contractor of the obligation to make good faith efforts to find a replacement DBE, and it is not a sound basis for rejecting a prospective replacement DBE's reasonable quote.

F. Making efforts to assist interested DBEs in obtaining bonding, lines of credit, or insurance as required by the recipient or contractor.

G. Making efforts to assist interested DBEs in obtaining necessary equipment, supplies, materials, or related assistance or services.

H. Effectively using the services of available minority/women community organizations; minority/women contractors' groups; local, State, and Federal minority/women business assistance offices; and other organizations as allowed on a case-by-case basis to provide assistance in the recruitment and placement of DBEs.

V. In determining whether a bidder has made good faith efforts, it is essential to scrutinize its documented efforts. At a minimum, you must review the performance of other bidders in meeting the contract goal. For example, when the apparent successful bidder fails to meet the contract goal, but others meet it, you may reasonably raise the question of whether, with additional efforts, the apparent successful bidder could have met the goal. If the apparent successful bidder fails to meet the goal, but meets or exceeds the average DBE participation obtained by other bidders, you may view this, in conjunction with other factors, as evidence of the apparent successful bidder having made good faith efforts. As provided in §26.53(b)(2)(vi), you must also require the contractor to submit copies of each DBE and non-DBE subcontractor quote submitted to the bidder when a non-DBE subcontractor was selected over a DBE for work on the contract to review whether DBE prices were substantially higher; and contact the DBEs listed on a contractor's solicitation to inquire as to whether they were contacted by the prime. Pro forma mailings to DBEs requesting bids are not alone sufficient to satisfy good faith efforts under the rule.

VI. A promise to use DBEs after contract award is not considered to be responsive to the contract solicitation or to constitute good faith efforts.

[79 FR 59600, Oct. 2, 2014]

Appendix G

(SAMPLE) Forms DT1506 and DT1202

**COMMITMENT TO SUBCONTRACT TO DBE
ATTACHMENT A**

CONFIRMATION OF PARTICIPATION

Project I.D.:	Proposal Number:
Letting Date:	

Name of DBE Firm Participating in this Contract:	
Name of the Prime/Subcontractor who hired the DBE Firm: <i>(list all names of tiers if more than one)</i>	
Type of Work or Type of Material Supplied:	
Total Subcontract Value:	Total DBE Credit Value:

<p>FOR PRIME CONTRACTORS ONLY: I certify that I made arrangements with the participating DBE firm to perform the type of work listed or supply the material indicated above for the subcontract value listed above.</p>	Prime Contractor Representative's Signature
	Prime Contractor Representative's Name (Print Name)
	Prime Contractor (Print Company Name)
	Date

<p>FOR PARTICIPATING DBE FIRMS ONLY: I certify that I made arrangements with the Prime Contractor or the Hiring Contractor to perform the type of work or supply the material indicated above for the subcontract value listed above.</p> <p>FOR DBE TRUCKING FIRMS ONLY: I certify that I will utilize, for DBE credit, only trucks listed on my WisDOT approved Schedule of Owned/Leased Vehicles for DBE Credit form and I will be utilizing the number of trucks as listed below.</p>	Participating DBE Firm Representative's Signature	Date
	Participating DBE Firm Representative's Name (Print Name)	
	Participating DBE Firm (Print Company Name)	
	DBE Firm's Address:	

# Owned Trucks	# Leased Trucks	# DBE-Owned Leased Trucks	# Non-DBE-Owned Leased Trucks

Off site Hauling



DOCUMENTATION OF GOOD FAITH EFFORT
 Wisconsin Department of Transportation
 DT1202.....3/2020



Project ID *****	Proposal No. *****	Letting *****
Prime Contractor *****		County *****
Person Submitting Document *****		Telephone Number *****
Address *****		Email Address *****

All bidders must undertake necessary and reasonable steps to achieve the assigned DBE contract goal per federal regulatory guidance at 49 CFR Part 26. Bidders use this form to document all efforts employed to meet the assigned goal as a record of contractor good faith efforts (GFE). Refer to ASP3 or 49 CFR Part 26 for guidance on actions that demonstrate good faith effort.

It is critical to list all efforts, attach documentation, and follow the instructions to complete this submission. Documentation of good faith effort includes copies of each DBE and non-DBE subcontractor quote submitted to the bidder for the same line items. Utilize the sample documentation logs to document and organize efforts.

Submit good faith effort documentation per ASP-3 guidelines.

Instructions: Provide a narrative description of all activities pursued to demonstrate good faith efforts, any corresponding documentation, and applicable explanation on separate pages. Include the following items, organized in the order listed below.

1. Solicitation Documentation:

- a. **Purpose:** To identify all reasonable and available activities the bidder performed to solicit the interest of all certified DBEs who have the capacity and ability to perform work on the project. All solicitation efforts should begin as early as possible to ensure DBEs have ample time to respond and ask questions.
- b. **Action:** Identify and list all activities engaged in to solicit DBEs using all reasonable and available means such as written notice and follow-up communications; substantive conversations; pre-bid meetings; networking events; market research; advertising.

2. Selected Work Items Documentation:

- a. **Purpose:** To ensure that all work items are broken out into economically feasible units to facilitate DBE participation. This must occur even when you prefer to perform the work yourself.
- b. **Action:** Identify economically feasible work units to be performed by DBEs to include activities such as: list of work items to be performed; breaking up of large work items into smaller tasks or quantities; flexible time frames for performance and delivery schedules.

3. Documentation of Project Information provided to Interested DBEs:

- a. **Purpose:** To provide interested DBEs with adequate information about the plans, specifications, and any other contractual requirements in a timely manner to assist DBEs in response to solicitation.
- b. **Action:** Provide DBEs access to plans, specifications, and other contract requirements. Early solicitation allows ample opportunity to provide project information, links to Let advertisements, and substantive engagement with DBEs.

4. → Documentation of Negotiation with Interested DBEs:

a. → Purpose: To ensure that negotiations with interested DBEs were made in good faith providing evidence as to why agreements could not be reached for DBEs to perform work.

b. → Action: Provide sufficient evidence to demonstrate that good faith negotiations took place. Merely sending out solicitations requesting bids from DBEs does not constitute sufficient good faith efforts. A bidder using good business judgment considers a number of factors in negotiating with all subcontractors, and the firm's price and capabilities in addition to contract goals are taken into consideration. However, the fact that there may be some additional costs involved in finding and using DBEs is not in itself sufficient reason for failing to meet the DBE goal as long as costs are reasonable. (see 49 CFR Part 26 Appendix A)

5. → Documentation of Sound Reason for Rejecting DBEs:

a. → Purpose: To ensure that bidders avoid rejecting DBEs as unqualified without sound reasons. Reasons for rejection must be based on thorough investigation of DBE capabilities.

b. → Action: Provide sufficient evidence to demonstrate that DBE was rejected for sound reasons such as past performance, relevant business experience and stability, safety record, business ethic and integrity, technical capacity, other tangible factors.

6. → Documentation of Assistance to Interested DBEs - Bonding, Credit, Insurance, Equipment, Supplies/Materials:

a. → Purpose: To assist interested DBEs in obtaining bonds, lines of credit, insurance, equipment, supplies, materials, and other assistance or services.

b. → Action: Assist interested DBEs in obtaining bonding, lines of credit or insurance, and provide technical assistance or information related to plans, specifications, and project requirements. Assist DBEs in obtaining equipment, supplies, materials or other services related to meeting project requirements (excluding supplies or equipment the DBE purchases from the prime).

7. → Documentation of outreach to Minority, Women, and Community Organizations and other DBE Business Development Support:

a. → Purpose: To effectively use the services of minority, women, and community organizations as well as contractors' groups, local, state, and federal business assistance offices and organization that provide assistance in recruiting and supporting DBEs, as well as participation in activities that support DBE business development.

b. → Action: Contact organizations and agencies for assistance in contacting, recruiting, and providing support to DBE subcontractors, suppliers, manufacturers, and truckers at least 14 days before bid opening. Participate in or host activities such as networking events, mentor-protégé programs, small business development workshops, and others consistent with DBE support.

Return to:
Wisconsin Department of Transportation
DBE Program Office
PO Box 7965
Madison, WI 53707-7965
DBE_Alert@dot.wi.gov

I certify that I have utilized comprehensive good faith efforts to solicit and utilize DBE firms to meet the DBE participation requirements of this contract proposal, as demonstrated by my responses and as specified in Additional Special Provision 3 (ASP-3).

I certify that the information given in the Documentation of Good Faith Efforts is true and correct to the best of my knowledge and belief.

I further understand that any willful falsification, fraudulent statement, or misrepresentation will result in appropriate sanctions, which may involve debarment and/or prosecution under applicable state (Trans 504) and Federal laws.

		(Bidder/Authorized Representative Signature)

		(Print Name)

		(Title)

Good-Faith-Effort--Sample-Documentation-Logs

The sample logs below are provided as guides rather than exhaustive list. See ASP3, Appendix A for additional examples of demonstrable good faith efforts. Attach documentation for each activity listed.

Acceptable forms of documentation include copies of solicitations sent to DBEs, notes from substantive conversations and negotiations with DBEs, copies of advertisements placed, email communications, all quotes received from DBEs and from all subcontractors who were considered alongside DBE quotes, proof of attendance at applicable networking events; flyers for events or workshops for DBEs offered by the prime, and other physical records of good faith efforts activities.

SOLICITATION LOG

Date	Activity	Name of DBE Solicited	Follow-up
4/1/2020	Sent May-Let solicitation	Winterland Electric	Spoke with Mark Winterland on 4/15/20 to ask if he would quote.

SELECTED WORK ITEMS SOLICITED LOG

Work Type	DBE Firm	Contact Person	Date	Contact Mode
Pavement Marking	ABC Marking	Leslie Lynch	4/1/2020	Email; phone
	#1 Marking Co.	Mark Smart	4/1/2020	Email; left VM
Electrical	Winterland Electric	Tabitha Tinker	4/3/2020	Email; left VM
	Superstar Wiring	Jose Huascar	4/3/2020	Email; phone

INFORMATION PROVIDED LOG

Request Date	DBE Firm	Information Requested & Provided	Response Date
4/1/2020	Winterland Electric	Requested info on electrical requirements; provided plan and link to specs	4/3/2020
4/21/2020	Absolute Construction	Wanted to know how and when supplies are paid for by WisDOT; referred to spec that covers stockpiling	4/21/2020

NEGOTIATIONS LOG

Date	DBE Firm	Contact Name	Work Type	Quotes Rec'd?	Considered for project?	If not selected, why?
4/12/2020	ABC Landscape	John Dean	Erosion Control	Yes	No	Cannot perform all items
4/17/2020	Wild Ferns	Sandy Lynn	Erosion Control	Yes	Yes	
4/20/2020	#1 Marking	Mark Smart	Electrical	Yes	Yes	

ASSISTANCE LOG

Date	DBE Firm	Contact Person	Assistance Provided
4/1/2020	ABC Sawing	Jackie Swiggle	Informed DBE on how to obtain bonding
4/17/2020	Supreme Construction	Winston Walters	Provided contact for wholesale supply purchase

OUTREACH & BUSINESS DEVELOPMENT LOG

Date	Agency/Organization Contacted	Contact Person	Assistance Requested
4/1/2020	Women in Construction	LaTonya Klein	Contact information for woman-owned suppliers
4/28/2020	WBIC	Sam Smith	Asked for information to provide to DBE regarding financing programs through WBIC

Official Form DT1202 can be found here: <https://wisconsindot.gov/pages/global-footer/formdocs/default.aspx>

ADDITIONAL SPECIAL PROVISION 4

This special provision does not limit the right of the department, prime contractor, or subcontractors at any tier to withhold payment for work not acceptably completed or work subject to an unresolved contract dispute.

Payment to First-Tier Subcontractors

Within 10 calendar days of receiving a progress payment for work completed by a subcontractor, pay the subcontractor for that work. The prime contractor may withhold payment to a subcontractor if, within 10 calendar days of receipt of that progress payment, the prime contractor provides written notification to the subcontractor and the department documenting "just cause" for withholding payment.

The prime contractor is not allowed to withhold retainage from payments due subcontractors.

Payment to Lower-Tier Subcontractors

Ensure that subcontracting agreements at all tiers provide prompt payment rights to lower-tier subcontractors that parallel those granted first-tier subcontractors in this provision.

Acceptance and Final Payment

Within 30 calendar days of receiving the semi-final estimate from the department, submit written certification that subcontractors at all tiers are paid in full for acceptably completed work.

Additional Special Provision 6
ASP 6 - Modifications to the standard specifications

Make the following revisions to the standard specifications:

416.2.4 Concrete Pavement Repair and Replacement

Replace the entire text with the following effective with the November 2022 letting:

- (1) Except as specified in 416.3.6 for inlaid rumble strips, use grade C concrete as specified in 501.
- (2) The engineer will allow the contractor to open to construction and public traffic when the concrete reaches 2000 psi.

416.2.5 Special High Early Strength Concrete Pavement Repair and Replacement

416.2.5.1 Composition and Proportioning of Concrete

Replace paragraph one with the following effective with the November 2022 letting:

- (1) For the concrete mixture, use a minimum of 846 pounds of cementitious material per cubic yard of concrete. The engineer will allow the contractor to open to construction and public traffic when the concrete reaches 2000 psi. The contractor may add one or a combination of admixtures to the ingredients or to the mixture in order to obtain the required minimum strength and required air content. Do not retemper the concrete mixture.

455.2.4.3 Emulsified Asphalts

Replace paragraph one with the following effective with the November 2022 letting:

- (1) Furnish material conforming, before dilution, to the following:
 - Anionic emulsified asphalts^[1]..... AASHTO M140
 - Cationic emulsified asphalts^[1] AASHTO M208
 - Polymer-modified cationic emulsified asphalts AASHTO M316
- ^[1] Non-tracking emulsified asphalts shall conform to TABLE 455-1 for the type and grade specified.

TABLE 455-1 Requirements for Non-Tracking Emulsified Asphalt

PRODUCT	ANTT	CNTT
Saybolt Viscosity at 77°F (25°C), (AASHTO T 59), SFS	15-100	15-100
Paddle Viscosity at 77°F (25°C), (AASHTO T 382), cPs ^[1]	30-200	30-200
Storage Stability Test, 24 hr, (AASHTO T 59), %	1 max	1 max
Residue by Distillation, 500 ± 10 °F (260 ± 5 °C), or Residue by Evaporation, 325 ± 5 °F (163 ± 3 °C), (AASHTO T 59), %	50 min	50 min
Sieve Test, No. 20 (850 µm), (AASHTO T 59), %	0.3	0.3
Penetration at 77°F (25°C), 100 g, 5 sec, (AASHTO T 49), dmm	10-40	10-40
Ash Content, (AASHTO T 111), %	1 max	1 max
Solubility in Trichlorethylene Test, (AASHTO T 44) ^[2]	97.5% min	97.5% min

^[1] Paddle Viscosity (AASHTO T 382) may be run in lieu of Saybolt Viscosity (AASHTO T 59).
^[2] The solubility in Trichlorethylene test (AASHTO T 44) may be run in lieu of Ash Content (AASHTO T 111).

455.2.5 Tack Coat

Replace paragraph one with the following effective with the November 2022 letting:

- (1) Under the Tack Coat bid item, furnish type SS-1h, CSS-1h, QS-1h, CQS-1h, ANTT, CNTT, or modified emulsified asphalt with an “h” suffix, unless the contract specifies otherwise.

710.5.7 Corrective Action

710.5.7.1 Optimized Aggregate Gradations

Replace paragraph one with the following effective with the November 2022 letting:

- (1) If the contractor's 4-point running average or a department test result of the volumetric percent retained exceeds the tarantula curve limits by less than or equal to 1.0 percent on a single sieve size, notify the other party immediately and do one of the following:
 - Perform corrective action documented in the QC plan or as the engineer approves. Continue with the following:
 1. Document and provide corrective action results to the engineer as soon as they are available.
 2. Department will conduct two tests within the next business day after corrective action is complete.
 - If blended aggregate gradations are within the tarantula curve limits by the second department test:
 - Continue with concrete production.
 - Include a break in the 4-point running average.
 - For Class I Pavements: The department will discontinue reduced frequency testing and will test at a frequency of 1 test per placement day. Once 5 consecutive samples are passing at the 1 test per placement day frequency, the reduced frequency testing will be reapplied.
 - If blended aggregate gradations are not within the tarantula curve limits by the second department test and the contract requires an optimized aggregate gradation mix under 501.2.7.4.2.1(2), stop concrete production and submit a new optimized aggregate gradation mix design.
 - If blended aggregate gradations are not within the tarantula curve limits by the second department test and the contract does not require an optimized aggregate gradation mix under 501.2.7.4.2.1(2), stop concrete production and submit either a new optimized aggregate gradation mix design or a combined aggregate gradation mix design.
 - Submit a new optimized aggregate gradation mix design and perform the following:
 1. Restart control charts for the new mix design.
 2. Amend contractor Quality Control Plan

715.5 Payment

Replace the entire text with the following effective with the November 2022 letting:

715.5.1 General

- (1) The department will pay incentive for concrete strength under the following bid items:

<u>ITEM NUMBER</u>	<u>DESCRIPTION</u>	<u>UNIT</u>
715.0502	Incentive Strength Concrete Structures	DOL
715.0603	Incentive Strength Concrete Barrier	DOL
715.0715	Incentive Flexural Strength Concrete Pavement	DOL
715.0720	Incentive Compressive Strength Concrete Pavement	DOL

- (2) Incentive payment may be more or less than the amount the schedule of items shows.
- (3) The department will administer disincentives for strength under the Disincentive Strength Concrete Structures, Disincentive Strength Concrete Barrier, Disincentive Flexural Strength Concrete Pavement, and Disincentive Compressive Strength Concrete Pavement, administrative items.
- (4) The department will adjust pay for each lot using PWL of the 28-day subplot average strengths for that lot. The department will measure PWL relative to strength lower specification limits as follows:
 - Compressive strength of 3700 psi for pavements.
 - Flexural strength of 650 psi for pavements.
 - Compressive strength of 4000 psi for structures and barrier.
- (5) The department will not pay a strength incentive for concrete that is nonconforming in another specified property, for ancillary concrete accepted based on tests of class I concrete, or for high early strength concrete unless placed in pavement gaps as allowed under 715.3.1.2.2.
- (6) Submit test results to the department electronically using MRS software. The department will verify contractor data before determining pay adjustments.
- (7) All coring and testing costs under 715.3.2.2 including filling core holes and providing traffic control during coring are incidental to the contract.

715.5.2 Pavements

715.5.2.1 Compressive

- (1) The department will adjust pay for each lot using equation “QMP 3.01” as follows:

Percent within Limits (PWL)	Pay Adjustment (dollars per square yard)
>= 95 to 100	$(0.1 \times \text{PWL}) - 9.5$
>= 85 to < 95	0
>= 30 to < 85	$(1.5/55 \times \text{PWL}) - 127.5/55$
< 30	-1.50

- (2) The department will not pay incentive if the lot standard deviation is greater than 400 psi compressive.
- (3) For lots with a full battery of QC tests at less than 4 locations, there is no incentive, but the department will assess a disincentive based on the individual subplot average strengths. The department will reduce pay for sublots with an average strength below 3700 psi compressive by \$1.50 per square yard.
- (4) For integral shoulder pavement and pavement gaps accepted using tests from the adjacent travel lane, the department will adjust pay using strength results of the travel lane for integrally placed concrete shoulders and pavement gaps regardless of mix design and placement method, included in a lane-foot lot.

715.5.2.2 Flexural

- (1) The department will adjust pay for each lot using equation “QMP 6.02” as follows:

Percent within Limits (PWL)	Pay Adjustment (dollars per square yard)
>= 95 to 100	$(0.2 \times \text{PWL}) - 19$
>= 85 to < 95	0
>= 50 to < 85	$(2.0/35 \times \text{PWL}) - 170/35$
< 50	-2.00

- (2) The department will not pay incentive if the lot standard deviation is greater than 60 psi flexural.
- (3) For lots with a full battery of QC tests at less than 4 locations, there is no incentive, but the department will assess a disincentive based on the individual subplot average strengths. The department will reduce pay for sublots with an average strength below 650 psi flexural by \$2.00 per square yard.
- (4) For integral shoulder pavement and pavement gaps accepted using tests from the adjacent travel lane, the department will adjust pay using strength results of the travel lane for integrally placed concrete shoulders and pavement gaps regardless of mix design and placement method, included in a lane-foot lot.

715.5.3 Structures and Cast-in-Place Barrier

- (1) The department will adjust pay for each lot using equation “QMP 2.01” as follows:

Percent within Limits (PWL)	Pay Adjustment (dollars per square yard)
>= 99 to 100	10
>= 90 to < 99	0
>= 50 to < 90	$(7/8 \times \text{PWL}) - 78.75$
< 50	-35

- (2) The department will not pay incentive if the lot standard deviation is greater than 350 psi.
- (3) For lots with less than 4 sublots, there is no incentive, but the department will assess a disincentive based on the individual subplot average strengths. The department will reduce pay for sublots with an average strength below 4000 psi by \$35 per cubic yard.

ADDITIONAL SPECIAL PROVISION 7

A. Reporting 1st Tier and DBE Payments During Construction

1. Comply with reporting requirements specified in the department's Civil Rights Compliance, Contractor's User Manual, Sublets and Payments.
2. Report payments to all DBE firms within 10 calendar days of receipt of a progress payment by the department or a contractor for work performed, materials furnished, or materials stockpiled by a DBE firm. Report the payment as specified in A(1) for all work satisfactorily performed and for all materials furnished or stockpiled.
3. Report payments to all first tier subcontractor relationships within 10 calendar days of receipt of a progress payment by the department for work performed. Report the payment as specified in A(1) for all work satisfactorily performed.
4. All tiers shall report payments as necessary to comply with the DBE payment requirement as specified in A(2).
5. DBE firms must enter all payments to DBE and non-DBE firms regardless of tier.
6. Require all first tier relationships, DBE firms and all other tier relationships necessary to comply with the DBE payment requirement in receipt of a progress payment by contractor to acknowledge receipt of payment as specified in A(1), (2), (3) and (4).
7. All agreements made by a contractor shall include the provisions in A(1), (2), (3), (4), (5), and (6), and shall be binding on all first tier subcontractor relationships, all contractors and subcontractors utilizing DBE firms on the project, and all payments from DBE firms.

B. Costs for conforming to this special provision are incidental to the contract.

NOTE: CRCS Prime Contractor payment is currently not automated and will need to be manually loaded into the Civil Rights Compliance System. Copies of prime contractor payments received (check or ACH) will have to be forwarded to paul.ndon@dot.wi.gov within 5 days of payment receipt to be logged manually.

***Additionally, for information on Subcontractor Sublet assignments, Subcontractor Payments and Payment Tracking, please refer to the CRCS Payment and Sublets manual at:

<https://wisconsindot.gov/Documents/doing-bus/civil-rights/labornwage/crcs-payments-sublets-manual.pdf>

ADDITIONAL SPECIAL PROVISION 9

Electronic Certified Payroll or Labor Data Submittal

- (1) Use the department's Civil Rights Compliance System (CRCS) to electronically submit certified payroll reports for contracts with federal funds and labor data for contracts with state funds only. Details are available online through the department's highway construction contractor information (HCCI) site on the Labor, Wages, and EEO Information page at:
<https://wisconsindot.gov/Pages/doing-bus/civil-rights/labornwage/default.aspx>
- (2) Ensure that all tiers of subcontractors, including all trucking firms, either submit their weekly certified payroll reports (contracts with federal funds) or labor data (contracts with state funds only) electronically through CRCS. These payrolls or labor data are due within seven calendar days following the close of the payroll period. Every firm providing physical labor towards completing the project is a subcontractor under this special provision.
- (3) Upon receipt of contract execution, promptly make all affected firms aware of the requirements under this special provision and arrange for them to receive CRCS training as they are about to begin their submittals. The department will provide training either in a classroom setting at one of our regional offices or by telephone. Contact Paul Ndon at (414) 438-4584 to schedule the training.
- (4) The department will reject all paper submittals for information required under this special provision. All costs for conforming to this special provision are incidental to the contract.
- (5) Firms wishing to export payroll/labor data from their computer system into CRCS should have their payroll coordinator contact Paul Ndon at paul.ndon@dot.wi.gov. Not every contractor's payroll system is capable of producing export files. For details, see Section 4.8 CPR Auto Submit (Data Mapping) on pages 49-50; 66-71 of the CRCS Payroll Manual at:
<https://wisconsindot.gov/Documents/doing-bus/civil-rights/labornwage/crcs-payroll-manual.pdf>

**REQUIRED CONTRACT PROVISIONS
FEDERAL-AID CONSTRUCTION CONTRACTS**

- I. General
- II. Nondiscrimination
- III. Non-segregated Facilities
- IV. Davis-Bacon and Related Act Provisions
- V. Contract Work Hours and Safety Standards Act Provisions
- VI. Subletting or Assigning the Contract
- VII. Safety: Accident Prevention
- VIII. False Statements Concerning Highway Projects
- IX. Implementation of Clean Air Act and Federal Water Pollution Control Act
- X. Certification Regarding Debarment, Suspension, Ineligibility and Voluntary Exclusion
- XI. Certification Regarding Use of Contract Funds for Lobbying
- XII. Use of United States-Flag Vessels:

performed on the contract by the contractor's own organization and with the assistance of workers under the contractor's immediate superintendence and to all work performed on the contract by piecework, station work, or by subcontract. 23 CFR 633.102(d).

3. A breach of any of the stipulations contained in these Required Contract Provisions may be sufficient grounds for withholding of progress payments, withholding of final payment, termination of the contract, suspension / debarment or any other action determined to be appropriate by the contracting agency and FHWA.

4. Selection of Labor: During the performance of this contract, the contractor shall not use convict labor for any purpose within the limits of a construction project on a Federal-aid highway unless it is labor performed by convicts who are on parole, supervised release, or probation. 23 U.S.C. 114(b). The term Federal-aid highway does not include roadways functionally classified as local roads or rural minor collectors. 23 U.S.C. 101(a).

ATTACHMENTS

A. Employment and Materials Preference for Appalachian Development Highway System or Appalachian Local Access Road Contracts (included in Appalachian contracts only)

I. GENERAL

1. Form FHWA-1273 must be physically incorporated in each construction contract funded under title 23, United States Code, as required in 23 CFR 633.102(b) (excluding emergency contracts solely intended for debris removal). The contractor (or subcontractor) must insert this form in each subcontract and further require its inclusion in all lower tier subcontracts (excluding purchase orders, rental agreements and other agreements for supplies or services). 23 CFR 633.102(e).

The applicable requirements of Form FHWA-1273 are incorporated by reference for work done under any purchase order, rental agreement or agreement for other services. The prime contractor shall be responsible for compliance by any subcontractor, lower-tier subcontractor or service provider. 23 CFR 633.102(e).

Form FHWA-1273 must be included in all Federal-aid design-build contracts, in all subcontracts and in lower tier subcontracts (excluding subcontracts for design services, purchase orders, rental agreements and other agreements for supplies or services) in accordance with 23 CFR 633.102. The design-builder shall be responsible for compliance by any subcontractor, lower-tier subcontractor or service provider.

Contracting agencies may reference Form FHWA-1273 in solicitation-for-bids or request-for-proposals documents, however, the Form FHWA-1273 must be physically incorporated (not referenced) in all contracts, subcontracts and lower-tier subcontracts (excluding purchase orders, rental agreements and other agreements for supplies or services related to a construction contract). 23 CFR 633.102(b).

2. Subject to the applicability criteria noted in the following sections, these contract provisions shall apply to all work

II. NONDISCRIMINATION (23 CFR 230.107(a); 23 CFR Part 230, Subpart A, Appendix A; EO 11246)

The provisions of this section related to 23 CFR Part 230, Subpart A, Appendix A are applicable to all Federal-aid construction contracts and to all related construction subcontracts of \$10,000 or more. The provisions of 23 CFR Part 230 are not applicable to material supply, engineering, or architectural service contracts.

In addition, the contractor and all subcontractors must comply with the following policies: Executive Order 11246, 41 CFR Part 60, 29 CFR Parts 1625-1627, 23 U.S.C. 140, Section 504 of the Rehabilitation Act of 1973, as amended (29 U.S.C. 794), Title VI of the Civil Rights Act of 1964, as amended (42 U.S.C. 2000d et seq.), and related regulations including 49 CFR Parts 21, 26, and 27; and 23 CFR Parts 200, 230, and 633.

The contractor and all subcontractors must comply with: the requirements of the Equal Opportunity Clause in 41 CFR 60-1.4(b) and, for all construction contracts exceeding \$10,000, the Standard Federal Equal Employment Opportunity Construction Contract Specifications in 41 CFR 60-4.3.

Note: The U.S. Department of Labor has exclusive authority to determine compliance with Executive Order 11246 and the policies of the Secretary of Labor including 41 CFR Part 60, and 29 CFR Parts 1625-1627. The contracting agency and the FHWA have the authority and the responsibility to ensure compliance with 23 U.S.C. 140, Section 504 of the Rehabilitation Act of 1973, as amended (29 U.S.C. 794), and Title VI of the Civil Rights Act of 1964, as amended (42 U.S.C. 2000d et seq.), and related regulations including 49 CFR Parts 21, 26, and 27; and 23 CFR Parts 200, 230, and 633.

The following provision is adopted from 23 CFR Part 230, Subpart A, Appendix A, with appropriate revisions to conform to the U.S. Department of Labor (US DOL) and FHWA requirements.

1. Equal Employment Opportunity: Equal Employment Opportunity (EEO) requirements not to discriminate and to take affirmative action to assure equal opportunity as set forth under laws, executive orders, rules, regulations (see 28 CFR Part 35, 29 CFR Part 1630, 29 CFR Parts 1625-1627, 41 CFR Part 60 and 49 CFR Part 27) and orders of the Secretary of Labor as modified by the provisions prescribed herein, and imposed pursuant to 23 U.S.C. 140, shall constitute the EEO and specific affirmative action standards for the contractor's project activities under this contract. The provisions of the Americans with Disabilities Act of 1990 (42 U.S.C. 12101 et seq.) set forth under 28 CFR Part 35 and 29 CFR Part 1630 are incorporated by reference in this contract. In the execution of this contract, the contractor agrees to comply with the following minimum specific requirement activities of EEO:

a. The contractor will work with the contracting agency and the Federal Government to ensure that it has made every good faith effort to provide equal opportunity with respect to all of its terms and conditions of employment and in their review of activities under the contract. 23 CFR 230.409 (g)(4) & (5).

b. The contractor will accept as its operating policy the following statement:

"It is the policy of this Company to assure that applicants are employed, and that employees are treated during employment, without regard to their race, religion, sex, sexual orientation, gender identity, color, national origin, age or disability. Such action shall include: employment, upgrading, demotion, or transfer; recruitment or recruitment advertising; layoff or termination; rates of pay or other forms of compensation; and selection for training, including apprenticeship, pre-apprenticeship, and/or on-the-job training."

2. EEO Officer: The contractor will designate and make known to the contracting officers an EEO Officer who will have the responsibility for and must be capable of effectively administering and promoting an active EEO program and who must be assigned adequate authority and responsibility to do so.

3. Dissemination of Policy: All members of the contractor's staff who are authorized to hire, supervise, promote, and discharge employees, or who recommend such action or are substantially involved in such action, will be made fully cognizant of and will implement the contractor's EEO policy and contractual responsibilities to provide EEO in each grade and classification of employment. To ensure that the above agreement will be met, the following actions will be taken as a minimum:

a. Periodic meetings of supervisory and personnel office employees will be conducted before the start of work and then not less often than once every six months, at which time the contractor's EEO policy and its implementation will be reviewed and explained. The meetings will be conducted by the EEO Officer or other knowledgeable company official.

b. All new supervisory or personnel office employees will be given a thorough indoctrination by the EEO Officer, covering all major aspects of the contractor's EEO obligations within thirty days following their reporting for duty with the contractor.

c. All personnel who are engaged in direct recruitment for the project will be instructed by the EEO Officer in the contractor's procedures for locating and hiring minorities and women.

d. Notices and posters setting forth the contractor's EEO policy will be placed in areas readily accessible to employees, applicants for employment and potential employees.

e. The contractor's EEO policy and the procedures to implement such policy will be brought to the attention of employees by means of meetings, employee handbooks, or other appropriate means.

4. Recruitment: When advertising for employees, the contractor will include in all advertisements for employees the notation: "An Equal Opportunity Employer." All such advertisements will be placed in publications having a large circulation among minorities and women in the area from which the project work force would normally be derived.

a. The contractor will, unless precluded by a valid bargaining agreement, conduct systematic and direct recruitment through public and private employee referral sources likely to yield qualified minorities and women. To meet this requirement, the contractor will identify sources of potential minority group employees and establish with such identified sources procedures whereby minority and women applicants may be referred to the contractor for employment consideration.

b. In the event the contractor has a valid bargaining agreement providing for exclusive hiring hall referrals, the contractor is expected to observe the provisions of that agreement to the extent that the system meets the contractor's compliance with EEO contract provisions. Where implementation of such an agreement has the effect of discriminating against minorities or women, or obligates the contractor to do the same, such implementation violates Federal nondiscrimination provisions.

c. The contractor will encourage its present employees to refer minorities and women as applicants for employment. Information and procedures with regard to referring such applicants will be discussed with employees.

5. Personnel Actions: Wages, working conditions, and employee benefits shall be established and administered, and personnel actions of every type, including hiring, upgrading, promotion, transfer, demotion, layoff, and termination, shall be taken without regard to race, color, religion, sex, sexual orientation, gender identity, national origin, age or disability. The following procedures shall be followed:

a. The contractor will conduct periodic inspections of project sites to ensure that working conditions and employee facilities do not indicate discriminatory treatment of project site personnel.

b. The contractor will periodically evaluate the spread of wages paid within each classification to determine any evidence of discriminatory wage practices.

c. The contractor will periodically review selected personnel actions in depth to determine whether there is evidence of discrimination. Where evidence is found, the contractor will promptly take corrective action. If the review indicates that the discrimination may extend beyond the actions reviewed, such corrective action shall include all affected persons.

d. The contractor will promptly investigate all complaints of alleged discrimination made to the contractor in connection with its obligations under this contract, will attempt to resolve such complaints, and will take appropriate corrective action

within a reasonable time. If the investigation indicates that the discrimination may affect persons other than the complainant, such corrective action shall include such other persons. Upon completion of each investigation, the contractor will inform every complainant of all of their avenues of appeal.

6. Training and Promotion:

a. The contractor will assist in locating, qualifying, and increasing the skills of minorities and women who are applicants for employment or current employees. Such efforts should be aimed at developing full journey level status employees in the type of trade or job classification involved.

b. Consistent with the contractor's work force requirements and as permissible under Federal and State regulations, the contractor shall make full use of training programs (i.e., apprenticeship and on-the-job training programs for the geographical area of contract performance). In the event a special provision for training is provided under this contract, this subparagraph will be superseded as indicated in the special provision. The contracting agency may reserve training positions for persons who receive welfare assistance in accordance with 23 U.S.C. 140(a).

c. The contractor will advise employees and applicants for employment of available training programs and entrance requirements for each.

d. The contractor will periodically review the training and promotion potential of employees who are minorities and women and will encourage eligible employees to apply for such training and promotion.

7. Unions: If the contractor relies in whole or in part upon unions as a source of employees, the contractor will use good faith efforts to obtain the cooperation of such unions to increase opportunities for minorities and women. 23 CFR 230.409. Actions by the contractor, either directly or through a contractor's association acting as agent, will include the procedures set forth below:

a. The contractor will use good faith efforts to develop, in cooperation with the unions, joint training programs aimed toward qualifying more minorities and women for membership in the unions and increasing the skills of minorities and women so that they may qualify for higher paying employment.

b. The contractor will use good faith efforts to incorporate an EEO clause into each union agreement to the end that such union will be contractually bound to refer applicants without regard to their race, color, religion, sex, sexual orientation, gender identity, national origin, age, or disability.

c. The contractor is to obtain information as to the referral practices and policies of the labor union except that to the extent such information is within the exclusive possession of the labor union and such labor union refuses to furnish such information to the contractor, the contractor shall so certify to the contracting agency and shall set forth what efforts have been made to obtain such information.

d. In the event the union is unable to provide the contractor with a reasonable flow of referrals within the time limit set forth in the collective bargaining agreement, the contractor will, through independent recruitment efforts, fill the employment vacancies without regard to race, color, religion, sex, sexual orientation, gender identity, national origin, age, or disability; making full efforts to obtain qualified and/or qualifiable minorities and women. The failure of a union to provide

sufficient referrals (even though it is obligated to provide exclusive referrals under the terms of a collective bargaining agreement) does not relieve the contractor from the requirements of this paragraph. In the event the union referral practice prevents the contractor from meeting the obligations pursuant to Executive Order 11246, as amended, and these special provisions, such contractor shall immediately notify the contracting agency.

8. Reasonable Accommodation for Applicants / Employees with Disabilities: The contractor must be familiar with the requirements for and comply with the Americans with Disabilities Act and all rules and regulations established thereunder. Employers must provide reasonable accommodation in all employment activities unless to do so would cause an undue hardship.

9. Selection of Subcontractors, Procurement of Materials and Leasing of Equipment: The contractor shall not discriminate on the grounds of race, color, religion, sex, sexual orientation, gender identity, national origin, age, or disability in the selection and retention of subcontractors, including procurement of materials and leases of equipment. The contractor shall take all necessary and reasonable steps to ensure nondiscrimination in the administration of this contract.

a. The contractor shall notify all potential subcontractors, suppliers, and lessors of their EEO obligations under this contract.

b. The contractor will use good faith efforts to ensure subcontractor compliance with their EEO obligations.

10. Assurances Required:

a. The requirements of 49 CFR Part 26 and the State DOT's FHWA-approved Disadvantaged Business Enterprise (DBE) program are incorporated by reference.

b. The contractor, subrecipient or subcontractor shall not discriminate on the basis of race, color, national origin, or sex in the performance of this contract. The contractor shall carry out applicable requirements of 49 CFR part 26 in the award and administration of DOT-assisted contracts. Failure by the contractor to carry out these requirements is a material breach of this contract, which may result in the termination of this contract or such other remedy as the recipient deems appropriate, which may include, but is not limited to:

- (1) Withholding monthly progress payments;
- (2) Assessing sanctions;
- (3) Liquidated damages; and/or
- (4) Disqualifying the contractor from future bidding as non-responsible.

c. The Title VI and nondiscrimination provisions of U.S. DOT Order 1050.2A at Appendixes A and E are incorporated by reference. 49 CFR Part 21.

11. Records and Reports: The contractor shall keep such records as necessary to document compliance with the EEO requirements. Such records shall be retained for a period of three years following the date of the final payment to the contractor for all contract work and shall be available at reasonable times and places for inspection by authorized representatives of the contracting agency and the FHWA.

a. The records kept by the contractor shall document the following:

(1) The number and work hours of minority and non-minority group members and women employed in each work classification on the project;

(2) The progress and efforts being made in cooperation with unions, when applicable, to increase employment opportunities for minorities and women; and

(3) The progress and efforts being made in locating, hiring, training, qualifying, and upgrading minorities and women.

b. The contractors and subcontractors will submit an annual report to the contracting agency each July for the duration of the project indicating the number of minority, women, and non-minority group employees currently engaged in each work classification required by the contract work. This information is to be reported on [Form FHWA-1391](#). The staffing data should represent the project work force on board in all or any part of the last payroll period preceding the end of July. If on-the-job training is being required by special provision, the contractor will be required to collect and report training data. The employment data should reflect the work force on board during all or any part of the last payroll period preceding the end of July.

III. NONSEGREGATED FACILITIES

This provision is applicable to all Federal-aid construction contracts and to all related construction subcontracts of more than \$10,000. 41 CFR 60-1.5.

As prescribed by 41 CFR 60-1.8, the contractor must ensure that facilities provided for employees are provided in such a manner that segregation on the basis of race, color, religion, sex, sexual orientation, gender identity, or national origin cannot result. The contractor may neither require such segregated use by written or oral policies nor tolerate such use by employee custom. The contractor's obligation extends further to ensure that its employees are not assigned to perform their services at any location under the contractor's control where the facilities are segregated. The term "facilities" includes waiting rooms, work areas, restaurants and other eating areas, time clocks, restrooms, washrooms, locker rooms and other storage or dressing areas, parking lots, drinking fountains, recreation or entertainment areas, transportation, and housing provided for employees. The contractor shall provide separate or single-user restrooms and necessary dressing or sleeping areas to assure privacy between sexes.

IV. DAVIS-BACON AND RELATED ACT PROVISIONS

This section is applicable to all Federal-aid construction projects exceeding \$2,000 and to all related subcontracts and lower-tier subcontracts (regardless of subcontract size), in accordance with 29 CFR 5.5. The requirements apply to all projects located within the right-of-way of a roadway that is functionally classified as Federal-aid highway. 23 U.S.C. 113. This excludes roadways functionally classified as local roads or rural minor collectors, which are exempt. 23 U.S.C. 101. Where applicable law requires that projects be treated as a project on a Federal-aid highway, the provisions of this subpart will apply regardless of the location of the project. Examples include: Surface Transportation Block Grant Program projects funded under 23 U.S.C. 133 [excluding recreational trails projects], the Nationally Significant Freight and Highway

Projects funded under 23 U.S.C. 117, and National Highway Freight Program projects funded under 23 U.S.C. 167.

The following provisions are from the U.S. Department of Labor regulations in 29 CFR 5.5 "Contract provisions and related matters" with minor revisions to conform to the FHWA-1273 format and FHWA program requirements.

1. Minimum wages (29 CFR 5.5)

a. All laborers and mechanics employed or working upon the site of the work, will be paid unconditionally and not less often than once a week, and without subsequent deduction or rebate on any account (except such payroll deductions as are permitted by regulations issued by the Secretary of Labor under the Copeland Act (29 CFR part 3)), the full amount of wages and bona fide fringe benefits (or cash equivalents thereof) due at time of payment computed at rates not less than those contained in the wage determination of the Secretary of Labor which is attached hereto and made a part hereof, regardless of any contractual relationship which may be alleged to exist between the contractor and such laborers and mechanics.

Contributions made or costs reasonably anticipated for bona fide fringe benefits under section 1(b)(2) of the Davis-Bacon Act on behalf of laborers or mechanics are considered wages paid to such laborers or mechanics, subject to the provisions of paragraph 1.d. of this section; also, regular contributions made or costs incurred for more than a weekly period (but not less often than quarterly) under plans, funds, or programs which cover the particular weekly period, are deemed to be constructively made or incurred during such weekly period. Such laborers and mechanics shall be paid the appropriate wage rate and fringe benefits on the wage determination for the classification of work actually performed, without regard to skill, except as provided in 29 CFR 5.5(a)(4). Laborers or mechanics performing work in more than one classification may be compensated at the rate specified for each classification for the time actually worked therein: Provided, That the employer's payroll records accurately set forth the time spent in each classification in which work is performed. The wage determination (including any additional classification and wage rates conformed under paragraph 1.b. of this section) and the Davis-Bacon poster (WH-1321) shall be posted at all times by the contractor and its subcontractors at the site of the work in a prominent and accessible place where it can be easily seen by the workers.

b.(1) The contracting officer shall require that any class of laborers or mechanics, including helpers, which is not listed in the wage determination and which is to be employed under the contract shall be classified in conformance with the wage determination. The contracting officer shall approve an additional classification and wage rate and fringe benefits therefore only when the following criteria have been met:

(i) The work to be performed by the classification requested is not performed by a classification in the wage determination; and

(ii) The classification is utilized in the area by the construction industry; and

(iii) The proposed wage rate, including any bona fide fringe benefits, bears a reasonable relationship to the wage rates contained in the wage determination.

(2) If the contractor and the laborers and mechanics to be employed in the classification (if known), or their representatives, and the contracting officer agree on the classification and wage rate (including the amount designated for fringe benefits where appropriate), a report of the action taken shall be sent by the contracting officer to the Administrator of the Wage and Hour Division, U.S. Department of Labor, Washington, DC 20210. The Administrator, or an authorized representative, will approve, modify, or disapprove every additional classification action within 30 days of receipt and so advise the contracting officer or will notify the contracting officer within the 30-day period that additional time is necessary.

(3) In the event the contractor, the laborers or mechanics to be employed in the classification or their representatives, and the contracting officer do not agree on the proposed classification and wage rate (including the amount designated for fringe benefits, where appropriate), the contracting officer shall refer the questions, including the views of all interested parties and the recommendation of the contracting officer, to the Administrator for determination. The Administrator, or an authorized representative, will issue a determination within 30 days of receipt and so advise the contracting officer or will notify the contracting officer within the 30-day period that additional time is necessary.

(4) The wage rate (including fringe benefits where appropriate) determined pursuant to paragraphs 1.b.(2) or 1.b.(3) of this section, shall be paid to all workers performing work in the classification under this contract from the first day on which work is performed in the classification.

c. Whenever the minimum wage rate prescribed in the contract for a class of laborers or mechanics includes a fringe benefit which is not expressed as an hourly rate, the contractor shall either pay the benefit as stated in the wage determination or shall pay another bona fide fringe benefit or an hourly cash equivalent thereof.

d. If the contractor does not make payments to a trustee or other third person, the contractor may consider as part of the wages of any laborer or mechanic the amount of any costs reasonably anticipated in providing bona fide fringe benefits under a plan or program, Provided, That the Secretary of Labor has found, upon the written request of the contractor, that the applicable standards of the Davis-Bacon Act have been met. The Secretary of Labor may require the contractor to set aside in a separate account assets for the meeting of obligations under the plan or program.

2. Withholding (29 CFR 5.5)

The contracting agency shall upon its own action or upon written request of an authorized representative of the Department of Labor, withhold or cause to be withheld from the contractor under this contract, or any other Federal contract with the same prime contractor, or any other federally-assisted contract subject to Davis-Bacon prevailing wage requirements, which is held by the same prime contractor, so much of the accrued payments or advances as may be considered necessary to pay laborers and mechanics,

including apprentices, trainees, and helpers, employed by the contractor or any subcontractor the full amount of wages required by the contract. In the event of failure to pay any laborer or mechanic, including any apprentice, trainee, or helper, employed or working on the site of the work, all or part of the wages required by the contract, the contracting agency may, after written notice to the contractor, take such action as may be necessary to cause the suspension of any further payment, advance, or guarantee of funds until such violations have ceased.

3. Payrolls and basic records (29 CFR 5.5)

a. Payrolls and basic records relating thereto shall be maintained by the contractor during the course of the work and preserved for a period of three years thereafter for all laborers and mechanics working at the site of the work. Such records shall contain the name, address, and social security number of each such worker, his or her correct classification, hourly rates of wages paid (including rates of contributions or costs anticipated for bona fide fringe benefits or cash equivalents thereof of the types described in section 1(b)(2)(B) of the Davis-Bacon Act), daily and weekly number of hours worked, deductions made and actual wages paid. Whenever the Secretary of Labor has found under 29 CFR 5.5(a)(1)(iv) that the wages of any laborer or mechanic include the amount of any costs reasonably anticipated in providing benefits under a plan or program described in section 1(b)(2)(B) of the Davis-Bacon Act, the contractor shall maintain records which show that the commitment to provide such benefits is enforceable, that the plan or program is financially responsible, and that the plan or program has been communicated in writing to the laborers or mechanics affected, and records which show the costs anticipated or the actual cost incurred in providing such benefits. Contractors employing apprentices or trainees under approved programs shall maintain written evidence of the registration of apprenticeship programs and certification of trainee programs, the registration of the apprentices and trainees, and the ratios and wage rates prescribed in the applicable programs.

b.(1) The contractor shall submit weekly for each week in which any contract work is performed a copy of all payrolls to the contracting agency. The payrolls submitted shall set out accurately and completely all of the information required to be maintained under 29 CFR 5.5(a)(3)(i), except that full social security numbers and home addresses shall not be included on weekly transmittals. Instead the payrolls shall only need to include an individually identifying number for each employee (e.g., the last four digits of the employee's social security number). The required weekly payroll information may be submitted in any form desired. Optional Form WH-347 is available for this purpose from the Wage and Hour Division Web site. The prime contractor is responsible for the submission of copies of payrolls by all subcontractors. Contractors and subcontractors shall maintain the full social security number and current address of each covered worker, and shall provide them upon request to the contracting agency for transmission to the State DOT, the FHWA or the Wage and Hour Division of the Department of Labor for purposes of an investigation or audit of compliance with prevailing wage requirements. It is not a violation of this section for a prime contractor to require a subcontractor to provide addresses and social security numbers to the prime contractor for its own records, without weekly submission to the contracting agency.

(2) Each payroll submitted shall be accompanied by a "Statement of Compliance," signed by the contractor or

subcontractor or his or her agent who pays or supervises the payment of the persons employed under the contract and shall certify the following:

(i) That the payroll for the payroll period contains the information required to be provided under 29 CFR 5.5(a)(3)(ii), the appropriate information is being maintained under 29 CFR 5.5(a)(3)(i), and that such information is correct and complete;

(ii) That each laborer or mechanic (including each helper, apprentice, and trainee) employed on the contract during the payroll period has been paid the full weekly wages earned, without rebate, either directly or indirectly, and that no deductions have been made either directly or indirectly from the full wages earned, other than permissible deductions as set forth in 29 CFR part 3;

(iii) That each laborer or mechanic has been paid not less than the applicable wage rates and fringe benefits or cash equivalents for the classification of work performed, as specified in the applicable wage determination incorporated into the contract.

(3) The weekly submission of a properly executed certification set forth on the reverse side of Optional Form WH-347 shall satisfy the requirement for submission of the "Statement of Compliance" required by paragraph 3.b.(2) of this section.

(4) The falsification of any of the above certifications may subject the contractor or subcontractor to civil or criminal prosecution under 18 U.S.C. 1001 and 31 U.S.C. 231.

c. The contractor or subcontractor shall make the records required under paragraph 3.a. of this section available for inspection, copying, or transcription by authorized representatives of the contracting agency, the State DOT, the FHWA, or the Department of Labor, and shall permit such representatives to interview employees during working hours on the job. If the contractor or subcontractor fails to submit the required records or to make them available, the FHWA may, after written notice to the contractor, the contracting agency or the State DOT, take such action as may be necessary to cause the suspension of any further payment, advance, or guarantee of funds. Furthermore, failure to submit the required records upon request or to make such records available may be grounds for debarment action pursuant to 29 CFR 5.12.

4. Apprentices and trainees (29 CFR 5.5)

a. Apprentices (programs of the USDOL).

Apprentices will be permitted to work at less than the predetermined rate for the work they performed when they are employed pursuant to and individually registered in a bona fide apprenticeship program registered with the U.S. Department of Labor, Employment and Training Administration, Office of Apprenticeship Training, Employer and Labor Services, or with a State Apprenticeship Agency recognized by the Office, or if a person is employed in his or her first 90 days of probationary employment as an apprentice in such an apprenticeship program, who is not individually registered in the program, but who has been certified by the Office of Apprenticeship Training, Employer and Labor Services or a State

Apprenticeship Agency (where appropriate) to be eligible for probationary employment as an apprentice.

The allowable ratio of apprentices to journeymen on the job site in any craft classification shall not be greater than the ratio permitted to the contractor as to the entire work force under the registered program. Any worker listed on a payroll at an apprentice wage rate, who is not registered or otherwise employed as stated above, shall be paid not less than the applicable wage rate on the wage determination for the classification of work actually performed. In addition, any apprentice performing work on the job site in excess of the ratio permitted under the registered program shall be paid not less than the applicable wage rate on the wage determination for the work actually performed. Where a contractor is performing construction on a project in a locality other than that in which its program is registered, the ratios and wage rates (expressed in percentages of the journeyman's hourly rate) specified in the contractor's or subcontractor's registered program shall be observed.

Every apprentice must be paid at not less than the rate specified in the registered program for the apprentice's level of progress, expressed as a percentage of the journeymen hourly rate specified in the applicable wage determination. Apprentices shall be paid fringe benefits in accordance with the provisions of the apprenticeship program. If the apprenticeship program does not specify fringe benefits, apprentices must be paid the full amount of fringe benefits listed on the wage determination for the applicable classification. If the Administrator determines that a different practice prevails for the applicable apprentice classification, fringes shall be paid in accordance with that determination.

In the event the Office of Apprenticeship Training, Employer and Labor Services, or a State Apprenticeship Agency recognized by the Office, withdraws approval of an apprenticeship program, the contractor will no longer be permitted to utilize apprentices at less than the applicable predetermined rate for the work performed until an acceptable program is approved.

b. Trainees (programs of the USDOL).

Except as provided in 29 CFR 5.16, trainees will not be permitted to work at less than the predetermined rate for the work performed unless they are employed pursuant to and individually registered in a program which has received prior approval, evidenced by formal certification by the U.S. Department of Labor, Employment and Training Administration.

The ratio of trainees to journeymen on the job site shall not be greater than permitted under the plan approved by the Employment and Training Administration.

Every trainee must be paid at not less than the rate specified in the approved program for the trainee's level of progress, expressed as a percentage of the journeyman hourly rate specified in the applicable wage determination. Trainees shall be paid fringe benefits in accordance with the provisions of the trainee program. If the trainee program does not mention fringe benefits, trainees shall be paid the full amount of fringe benefits listed on the wage determination unless the Administrator of the Wage and Hour Division determines that there is an apprenticeship program associated with the

corresponding journeyman wage rate on the wage determination which provides for less than full fringe benefits for apprentices. Any employee listed on the payroll at a trainee rate who is not registered and participating in a training plan approved by the Employment and Training Administration shall be paid not less than the applicable wage rate on the wage determination for the classification of work actually performed. In addition, any trainee performing work on the job site in excess of the ratio permitted under the registered program shall be paid not less than the applicable wage rate on the wage determination for the work actually performed.

In the event the Employment and Training Administration withdraws approval of a training program, the contractor will no longer be permitted to utilize trainees at less than the applicable predetermined rate for the work performed until an acceptable program is approved.

c. Equal employment opportunity. The utilization of apprentices, trainees and journeymen under this part shall be in conformity with the equal employment opportunity requirements of Executive Order 11246, as amended, and 29 CFR part 30.

d. Apprentices and Trainees (programs of the U.S. DOT).

Apprentices and trainees working under apprenticeship and skill training programs which have been certified by the Secretary of Transportation as promoting EEO in connection with Federal-aid highway construction programs are not subject to the requirements of paragraph 4 of this Section IV. 23 CFR 230.111(e)(2). The straight time hourly wage rates for apprentices and trainees under such programs will be established by the particular programs. The ratio of apprentices and trainees to journeymen shall not be greater than permitted by the terms of the particular program.

5. Compliance with Copeland Act requirements. The contractor shall comply with the requirements of 29 CFR part 3, which are incorporated by reference in this contract as provided in 29 CFR 5.5.

6. Subcontracts. The contractor or subcontractor shall insert Form FHWA-1273 in any subcontracts and also require the subcontractors to include Form FHWA-1273 in any lower tier subcontracts. The prime contractor shall be responsible for the compliance by any subcontractor or lower tier subcontractor with all the contract clauses in 29 CFR 5.5.

7. Contract termination: debarment. A breach of the contract clauses in 29 CFR 5.5 may be grounds for termination of the contract, and for debarment as a contractor and a subcontractor as provided in 29 CFR 5.12.

8. Compliance with Davis-Bacon and Related Act requirements. All rulings and interpretations of the Davis-Bacon and Related Acts contained in 29 CFR parts 1, 3, and 5 are herein incorporated by reference in this contract as provided in 29 CFR 5.5.

9. Disputes concerning labor standards. As provided in 29 CFR 5.5, disputes arising out of the labor standards provisions of this contract shall not be subject to the general disputes clause of this contract. Such disputes shall be resolved in accordance with the procedures of the Department of Labor

set forth in 29 CFR parts 5, 6, and 7. Disputes within the meaning of this clause include disputes between the contractor (or any of its subcontractors) and the contracting agency, the U.S. Department of Labor, or the employees or their representatives.

10. Certification of eligibility (29 CFR 5.5)

a. By entering into this contract, the contractor certifies that neither it (nor he or she) nor any person or firm who has an interest in the contractor's firm is a person or firm ineligible to be awarded Government contracts by virtue of section 3(a) of the Davis-Bacon Act or 29 CFR 5.12(a)(1).

b. No part of this contract shall be subcontracted to any person or firm ineligible for award of a Government contract by virtue of section 3(a) of the Davis-Bacon Act or 29 CFR 5.12(a)(1).

c. The penalty for making false statements is prescribed in the U.S. Criminal Code, 18 U.S.C. 1001.

V. CONTRACT WORK HOURS AND SAFETY STANDARDS ACT

Pursuant to 29 CFR 5.5(b), the following clauses apply to any Federal-aid construction contract in an amount in excess of \$100,000 and subject to the overtime provisions of the Contract Work Hours and Safety Standards Act. These clauses shall be inserted in addition to the clauses required by 29 CFR 5.5(a) or 29 CFR 4.6. As used in this paragraph, the terms laborers and mechanics include watchmen and guards.

1. Overtime requirements. No contractor or subcontractor contracting for any part of the contract work which may require or involve the employment of laborers or mechanics shall require or permit any such laborer or mechanic in any workweek in which he or she is employed on such work to work in excess of forty hours in such workweek unless such laborer or mechanic receives compensation at a rate not less than one and one-half times the basic rate of pay for all hours worked in excess of forty hours in such workweek. 29 CFR 5.5.

2. Violation; liability for unpaid wages; liquidated damages. In the event of any violation of the clause set forth in paragraph 1 of this section, the contractor and any subcontractor responsible therefor shall be liable for the unpaid wages. In addition, such contractor and subcontractor shall be liable to the United States (in the case of work done under contract for the District of Columbia or a territory, to such District or to such territory), for liquidated damages. Such liquidated damages shall be computed with respect to each individual laborer or mechanic, including watchmen and guards, employed in violation of the clause set forth in paragraph 1 of this section, in the sum currently provided in 29 CFR 5.5(b)(2)* for each calendar day on which such individual was required or permitted to work in excess of the standard workweek of forty hours without payment of the overtime wages required by the clause set forth in paragraph 1 of this section. 29 CFR 5.5.

* \$27 as of January 23, 2019 (See 84 FR 213-01, 218) as may be adjusted annually by the Department of Labor; pursuant to the Federal Civil Penalties Inflation Adjustment Act of 1990).

3. Withholding for unpaid wages and liquidated damages.

The FHWA or the contracting agency shall upon its own action or upon written request of an authorized representative of the Department of Labor withhold or cause to be withheld, from any moneys payable on account of work performed by the contractor or subcontractor under any such contract or any other Federal contract with the same prime contractor, or any other federally-assisted contract subject to the Contract Work Hours and Safety Standards Act, which is held by the same prime contractor, such sums as may be determined to be necessary to satisfy any liabilities of such contractor or subcontractor for unpaid wages and liquidated damages as provided in the clause set forth in paragraph 2 of this section. 29 CFR 5.5.

4. Subcontracts. The contractor or subcontractor shall insert in any subcontracts the clauses set forth in paragraphs 1 through 4 of this section and also a clause requiring the subcontractors to include these clauses in any lower tier subcontracts. The prime contractor shall be responsible for compliance by any subcontractor or lower tier subcontractor with the clauses set forth in paragraphs 1 through 4 of this section. 29 CFR 5.5.

VI. SUBLETTING OR ASSIGNING THE CONTRACT

This provision is applicable to all Federal-aid construction contracts on the National Highway System pursuant to 23 CFR 635.116.

1. The contractor shall perform with its own organization contract work amounting to not less than 30 percent (or a greater percentage if specified elsewhere in the contract) of the total original contract price, excluding any specialty items designated by the contracting agency. Specialty items may be performed by subcontract and the amount of any such specialty items performed may be deducted from the total original contract price before computing the amount of work required to be performed by the contractor's own organization (23 CFR 635.116).

a. The term "perform work with its own organization" in paragraph 1 of Section VI refers to workers employed or leased by the prime contractor, and equipment owned or rented by the prime contractor, with or without operators. Such term does not include employees or equipment of a subcontractor or lower tier subcontractor, agents of the prime contractor, or any other assignees. The term may include payments for the costs of hiring leased employees from an employee leasing firm meeting all relevant Federal and State regulatory requirements. Leased employees may only be included in this term if the prime contractor meets all of the following conditions: (based on longstanding interpretation)

- (1) the prime contractor maintains control over the supervision of the day-to-day activities of the leased employees;
- (2) the prime contractor remains responsible for the quality of the work of the leased employees;
- (3) the prime contractor retains all power to accept or exclude individual employees from work on the project; and
- (4) the prime contractor remains ultimately responsible for the payment of predetermined minimum wages, the submission of payrolls, statements of compliance and all other Federal regulatory requirements.

b. "Specialty Items" shall be construed to be limited to work that requires highly specialized knowledge, abilities, or

equipment not ordinarily available in the type of contracting organizations qualified and expected to bid or propose on the contract as a whole and in general are to be limited to minor components of the overall contract. 23 CFR 635.102.

2. Pursuant to 23 CFR 635.116(a), the contract amount upon which the requirements set forth in paragraph (1) of Section VI is computed includes the cost of material and manufactured products which are to be purchased or produced by the contractor under the contract provisions.

3. Pursuant to 23 CFR 635.116(c), the contractor shall furnish (a) a competent superintendent or supervisor who is employed by the firm, has full authority to direct performance of the work in accordance with the contract requirements, and is in charge of all construction operations (regardless of who performs the work) and (b) such other of its own organizational resources (supervision, management, and engineering services) as the contracting officer determines is necessary to assure the performance of the contract.

4. No portion of the contract shall be sublet, assigned or otherwise disposed of except with the written consent of the contracting officer, or authorized representative, and such consent when given shall not be construed to relieve the contractor of any responsibility for the fulfillment of the contract. Written consent will be given only after the contracting agency has assured that each subcontract is evidenced in writing and that it contains all pertinent provisions and requirements of the prime contract. (based on longstanding interpretation of 23 CFR 635.116).

5. The 30-percent self-performance requirement of paragraph (1) is not applicable to design-build contracts; however, contracting agencies may establish their own self-performance requirements. 23 CFR 635.116(d).

VII. SAFETY: ACCIDENT PREVENTION

This provision is applicable to all Federal-aid construction contracts and to all related subcontracts.

1. In the performance of this contract the contractor shall comply with all applicable Federal, State, and local laws governing safety, health, and sanitation (23 CFR Part 635). The contractor shall provide all safeguards, safety devices and protective equipment and take any other needed actions as it determines, or as the contracting officer may determine, to be reasonably necessary to protect the life and health of employees on the job and the safety of the public and to protect property in connection with the performance of the work covered by the contract. 23 CFR 635.108.

2. It is a condition of this contract, and shall be made a condition of each subcontract, which the contractor enters into pursuant to this contract, that the contractor and any subcontractor shall not permit any employee, in performance of the contract, to work in surroundings or under conditions which are unsanitary, hazardous or dangerous to his/her health or safety, as determined under construction safety and health standards (29 CFR Part 1926) promulgated by the Secretary of Labor, in accordance with Section 107 of the Contract Work Hours and Safety Standards Act (40 U.S.C. 3704). 29 CFR 1926.10.

3. Pursuant to 29 CFR 1926.3, it is a condition of this contract that the Secretary of Labor or authorized representative thereof, shall have right of entry to any site of contract performance to inspect or investigate the matter of compliance

with the construction safety and health standards and to carry out the duties of the Secretary under Section 107 of the Contract Work Hours and Safety Standards Act (40 U.S.C. 3704).

VIII. FALSE STATEMENTS CONCERNING HIGHWAY PROJECTS

This provision is applicable to all Federal-aid construction contracts and to all related subcontracts.

In order to assure high quality and durable construction in conformity with approved plans and specifications and a high degree of reliability on statements and representations made by engineers, contractors, suppliers, and workers on Federal-aid highway projects, it is essential that all persons concerned with the project perform their functions as carefully, thoroughly, and honestly as possible. Willful falsification, distortion, or misrepresentation with respect to any facts related to the project is a violation of Federal law. To prevent any misunderstanding regarding the seriousness of these and similar acts, Form FHWA-1022 shall be posted on each Federal-aid highway project (23 CFR Part 635) in one or more places where it is readily available to all persons concerned with the project:

18 U.S.C. 1020 reads as follows:

"Whoever, being an officer, agent, or employee of the United States, or of any State or Territory, or whoever, whether a person, association, firm, or corporation, knowingly makes any false statement, false representation, or false report as to the character, quality, quantity, or cost of the material used or to be used, or the quantity or quality of the work performed or to be performed, or the cost thereof in connection with the submission of plans, maps, specifications, contracts, or costs of construction on any highway or related project submitted for approval to the Secretary of Transportation; or

Whoever knowingly makes any false statement, false representation, false report or false claim with respect to the character, quality, quantity, or cost of any work performed or to be performed, or materials furnished or to be furnished, in connection with the construction of any highway or related project approved by the Secretary of Transportation; or

Whoever knowingly makes any false statement or false representation as to material fact in any statement, certificate, or report submitted pursuant to provisions of the Federal-aid Roads Act approved July 11, 1916, (39 Stat. 355), as amended and supplemented;

Shall be fined under this title or imprisoned not more than 5 years or both."

IX. IMPLEMENTATION OF CLEAN AIR ACT AND FEDERAL WATER POLLUTION CONTROL ACT (42 U.S.C. 7606; 2 CFR 200.88; EO 11738)

This provision is applicable to all Federal-aid construction contracts in excess of \$150,000 and to all related subcontracts. 48 CFR 2.101; 2 CFR 200.326.

By submission of this bid/proposal or the execution of this contract or subcontract, as appropriate, the bidder, proposer, Federal-aid construction contractor, subcontractor, supplier, or vendor agrees to comply with all applicable standards, orders

or regulations issued pursuant to the Clean Air Act (42 U.S.C. 7401-7671q) and the Federal Water Pollution Control Act, as amended (33 U.S.C. 1251-1387). Violations must be reported to the Federal Highway Administration and the Regional Office of the Environmental Protection Agency. 2 CFR Part 200, Appendix II.

The contractor agrees to include or cause to be included the requirements of this Section in every subcontract, and further agrees to take such action as the contracting agency may direct as a means of enforcing such requirements. 2 CFR 200.326.

X. CERTIFICATION REGARDING DEBARMENT, SUSPENSION, INELIGIBILITY AND VOLUNTARY EXCLUSION

This provision is applicable to all Federal-aid construction contracts, design-build contracts, subcontracts, lower-tier subcontracts, purchase orders, lease agreements, consultant contracts or any other covered transaction requiring FHWA approval or that is estimated to cost \$25,000 or more – as defined in 2 CFR Parts 180 and 1200. 2 CFR 180.220 and 1200.220.

1. Instructions for Certification – First Tier Participants:

a. By signing and submitting this proposal, the prospective first tier participant is providing the certification set out below.

b. The inability of a person to provide the certification set out below will not necessarily result in denial of participation in this covered transaction. The prospective first tier participant shall submit an explanation of why it cannot provide the certification set out below. The certification or explanation will be considered in connection with the department or agency's determination whether to enter into this transaction. However, failure of the prospective first tier participant to furnish a certification or an explanation shall disqualify such a person from participation in this transaction. 2 CFR 180.320.

c. The certification in this clause is a material representation of fact upon which reliance was placed when the contracting agency determined to enter into this transaction. If it is later determined that the prospective participant knowingly rendered an erroneous certification, in addition to other remedies available to the Federal Government, the contracting agency may terminate this transaction for cause of default. 2 CFR 180.325.

d. The prospective first tier participant shall provide immediate written notice to the contracting agency to whom this proposal is submitted if any time the prospective first tier participant learns that its certification was erroneous when submitted or has become erroneous by reason of changed circumstances. 2 CFR 180.345 and 180.350.

e. The terms "covered transaction," "debarred," "suspended," "ineligible," "participant," "person," "principal," and "voluntarily excluded," as used in this clause, are defined in 2 CFR Parts 180, Subpart I, 180.900-180.1020, and 1200. "First Tier Covered Transactions" refers to any covered transaction between a recipient or subrecipient of Federal funds and a participant (such as the prime or general contract). "Lower Tier Covered Transactions" refers to any covered transaction under a First Tier Covered Transaction (such as subcontracts). "First Tier Participant" refers to the participant

who has entered into a covered transaction with a recipient or subrecipient of Federal funds (such as the prime or general contractor). "Lower Tier Participant" refers any participant who has entered into a covered transaction with a First Tier Participant or other Lower Tier Participants (such as subcontractors and suppliers).

f. The prospective first tier participant agrees by submitting this proposal that, should the proposed covered transaction be entered into, it shall not knowingly enter into any lower tier covered transaction with a person who is debarred, suspended, declared ineligible, or voluntarily excluded from participation in this covered transaction, unless authorized by the department or agency entering into this transaction. 2 CFR 180.330.

g. The prospective first tier participant further agrees by submitting this proposal that it will include the clause titled "Certification Regarding Debarment, Suspension, Ineligibility and Voluntary Exclusion-Lower Tier Covered Transactions," provided by the department or contracting agency, entering into this covered transaction, without modification, in all lower tier covered transactions and in all solicitations for lower tier covered transactions exceeding the \$25,000 threshold. 2 CFR 180.220 and 180.300.

h. A participant in a covered transaction may rely upon a certification of a prospective participant in a lower tier covered transaction that is not debarred, suspended, ineligible, or voluntarily excluded from the covered transaction, unless it knows that the certification is erroneous. 2 CFR 180.300; 180.320, and 180.325. A participant is responsible for ensuring that its principals are not suspended, debarred, or otherwise ineligible to participate in covered transactions. 2 CFR 180.335. To verify the eligibility of its principals, as well as the eligibility of any lower tier prospective participants, each participant may, but is not required to, check the System for Award Management website (<https://www.sam.gov/>). 2 CFR 180.300, 180.320, and 180.325.

i. Nothing contained in the foregoing shall be construed to require the establishment of a system of records in order to render in good faith the certification required by this clause. The knowledge and information of the prospective participant is not required to exceed that which is normally possessed by a prudent person in the ordinary course of business dealings.

j. Except for transactions authorized under paragraph (f) of these instructions, if a participant in a covered transaction knowingly enters into a lower tier covered transaction with a person who is suspended, debarred, ineligible, or voluntarily excluded from participation in this transaction, in addition to other remedies available to the Federal Government, the department or agency may terminate this transaction for cause or default. 2 CFR 180.325.

* * * * *

2. Certification Regarding Debarment, Suspension, Ineligibility and Voluntary Exclusion – First Tier Participants:

a. The prospective first tier participant certifies to the best of its knowledge and belief, that it and its principals:

(1) Are not presently debarred, suspended, proposed for debarment, declared ineligible, or voluntarily excluded from participating in covered transactions by any Federal department or agency, 2 CFR 180.335;.

(2) Have not within a three-year period preceding this proposal been convicted of or had a civil judgment rendered against them for commission of fraud or a criminal offense in connection with obtaining, attempting to obtain, or performing a public (Federal, State, or local) transaction or contract under a public transaction; violation of Federal or State antitrust statutes or commission of embezzlement, theft, forgery, bribery, falsification or destruction of records, making false statements, or receiving stolen property, 2 CFR 180.800;

(3) Are not presently indicted for or otherwise criminally or civilly charged by a governmental entity (Federal, State or local) with commission of any of the offenses enumerated in paragraph (a)(2) of this certification, 2 CFR 180.700 and 180.800; and

(4) Have not within a three-year period preceding this application/proposal had one or more public transactions (Federal, State or local) terminated for cause or default. 2 CFR 180.335(d).

(5) Are not a corporation that has been convicted of a felony violation under any Federal law within the two-year period preceding this proposal (USDOT Order 4200.6 implementing appropriations act requirements); and

(6) Are not a corporation with any unpaid Federal tax liability that has been assessed, for which all judicial and administrative remedies have been exhausted, or have lapsed, and that is not being paid in a timely manner pursuant to an agreement with the authority responsible for collecting the tax liability (USDOT Order 4200.6 implementing appropriations act requirements).

b. Where the prospective participant is unable to certify to any of the statements in this certification, such prospective participant should attach an explanation to this proposal. 2 CFR 180.335 and 180.340.

3. Instructions for Certification - Lower Tier Participants:

(Applicable to all subcontracts, purchase orders, and other lower tier transactions requiring prior FHWA approval or estimated to cost \$25,000 or more - 2 CFR Parts 180 and 1200). 2 CFR 180.220 and 1200.220.

a. By signing and submitting this proposal, the prospective lower tier participant is providing the certification set out below.

b. The certification in this clause is a material representation of fact upon which reliance was placed when this transaction was entered into. If it is later determined that the prospective lower tier participant knowingly rendered an erroneous certification, in addition to other remedies available to the Federal Government, the department, or agency with which this transaction originated may pursue available remedies, including suspension and/or debarment.

c. The prospective lower tier participant shall provide immediate written notice to the person to which this proposal is submitted if at any time the prospective lower tier participant learns that its certification was erroneous by reason of changed circumstances. 2 CFR 180.365.

d. The terms "covered transaction," "debarred," "suspended," "ineligible," "participant," "person," "principal," and "voluntarily excluded," as used in this clause, are defined in 2 CFR Parts 180, Subpart I, 180.900 – 180.1020, and 1200. You may contact the person to which this proposal is

submitted for assistance in obtaining a copy of those regulations. "First Tier Covered Transactions" refers to any covered transaction between a recipient or subrecipient of Federal funds and a participant (such as the prime or general contractor). "Lower Tier Covered Transactions" refers to any covered transaction under a First Tier Covered Transaction (such as subcontracts). "First Tier Participant" refers to the participant who has entered into a covered transaction with a recipient or subrecipient of Federal funds (such as the prime or general contractor). "Lower Tier Participant" refers any participant who has entered into a covered transaction with a First Tier Participant or other Lower Tier Participants (such as subcontractors and suppliers).

e. The prospective lower tier participant agrees by submitting this proposal that, should the proposed covered transaction be entered into, it shall not knowingly enter into any lower tier covered transaction with a person who is debarred, suspended, declared ineligible, or voluntarily excluded from participation in this covered transaction, unless authorized by the department or agency with which this transaction originated. 2 CFR 1200.220 and 1200.332.

f. The prospective lower tier participant further agrees by submitting this proposal that it will include this clause titled "Certification Regarding Debarment, Suspension, Ineligibility and Voluntary Exclusion-Lower Tier Covered Transaction," without modification, in all lower tier covered transactions and in all solicitations for lower tier covered transactions exceeding the \$25,000 threshold. 2 CFR 180.220 and 1200.220.

g. A participant in a covered transaction may rely upon a certification of a prospective participant in a lower tier covered transaction that is not debarred, suspended, ineligible, or voluntarily excluded from the covered transaction, unless it knows that the certification is erroneous. A participant is responsible for ensuring that its principals are not suspended, debarred, or otherwise ineligible to participate in covered transactions. To verify the eligibility of its principals, as well as the eligibility of any lower tier prospective participants, each participant may, but is not required to, check the System for Award Management website (<https://www.sam.gov/>), which is compiled by the General Services Administration. 2 CFR 180.300, 180.320, 180.330, and 180.335.

h. Nothing contained in the foregoing shall be construed to require establishment of a system of records in order to render in good faith the certification required by this clause. The knowledge and information of participant is not required to exceed that which is normally possessed by a prudent person in the ordinary course of business dealings.

i. Except for transactions authorized under paragraph e of these instructions, if a participant in a covered transaction knowingly enters into a lower tier covered transaction with a person who is suspended, debarred, ineligible, or voluntarily excluded from participation in this transaction, in addition to other remedies available to the Federal Government, the department or agency with which this transaction originated may pursue available remedies, including suspension and/or debarment. 2 CFR 180.325.

Certification Regarding Debarment, Suspension, Ineligibility and Voluntary Exclusion--Lower Tier Participants:

1. The prospective lower tier participant certifies, by submission of this proposal, that neither it nor its principals:

(a) is presently debarred, suspended, proposed for debarment, declared ineligible, or voluntarily excluded from participating in covered transactions by any Federal department or agency, 2 CFR 180.355;

(b) is a corporation that has been convicted of a felony violation under any Federal law within the two-year period preceding this proposal (USDOT Order 4200.6 implementing appropriations act requirements); and

(c) is a corporation with any unpaid Federal tax liability that has been assessed, for which all judicial and administrative remedies have been exhausted, or have lapsed, and that is not being paid in a timely manner pursuant to an agreement with the authority responsible for collecting the tax liability. (USDOT Order 4200.6 implementing appropriations act requirements)

2. Where the prospective lower tier participant is unable to certify to any of the statements in this certification, such prospective participant should attach an explanation to this proposal.

XI. CERTIFICATION REGARDING USE OF CONTRACT FUNDS FOR LOBBYING

This provision is applicable to all Federal-aid construction contracts and to all related subcontracts which exceed \$100,000. 49 CFR Part 20, App. A.

1. The prospective participant certifies, by signing and submitting this bid or proposal, to the best of his or her knowledge and belief, that:

a. No Federal appropriated funds have been paid or will be paid, by or on behalf of the undersigned, to any person for influencing or attempting to influence an officer or employee of any Federal agency, a Member of Congress, an officer or employee of Congress, or an employee of a Member of Congress in connection with the awarding of any Federal contract, the making of any Federal grant, the making of any Federal loan, the entering into of any cooperative agreement, and the extension, continuation, renewal, amendment, or modification of any Federal contract, grant, loan, or cooperative agreement.

b. If any funds other than Federal appropriated funds have been paid or will be paid to any person for influencing or attempting to influence an officer or employee of any Federal agency, a Member of Congress, an officer or employee of Congress, or an employee of a Member of Congress in connection with this Federal contract, grant, loan, or cooperative agreement, the undersigned shall complete and submit Standard Form-LLL, "Disclosure Form to Report Lobbying," in accordance with its instructions.

2. This certification is a material representation of fact upon which reliance was placed when this transaction was made or entered into. Submission of this certification is a prerequisite for making or entering into this transaction imposed by 31 U.S.C. 1352. Any person who fails to file the required certification shall be subject to a civil penalty of not less than \$10,000 and not more than \$100,000 for each such failure.

3. The prospective participant also agrees by submitting its bid or proposal that the participant shall require that the language of this certification be included in all lower tier

subcontracts, which exceed \$100,000 and that all such recipients shall certify and disclose accordingly.

XII. USE OF UNITED STATES-FLAG VESSELS:

This provision is applicable to all Federal-aid construction contracts, design-build contracts, subcontracts, lower-tier subcontracts, purchase orders, lease agreements, or any other covered transaction. 46 CFR Part 381.

This requirement applies to material or equipment that is acquired for a specific Federal-aid highway project. 46 CFR 381.7. It is not applicable to goods or materials that come into inventories independent of an FHWA funded-contract.

When oceanic shipments (or shipments across the Great Lakes) are necessary for materials or equipment acquired for a specific Federal-aid construction project, the bidder, proposer, contractor, subcontractor, or vendor agrees:

1. To utilize privately owned United States-flag commercial vessels to ship at least 50 percent of the gross tonnage (computed separately for dry bulk carriers, dry cargo liners, and tankers) involved, whenever shipping any equipment, material, or commodities pursuant to this contract, to the extent such vessels are available at fair and reasonable rates for United States-flag commercial vessels. 46 CFR 381.7.
2. To furnish within 20 days following the date of loading for shipments originating within the United States or within 30 working days following the date of loading for shipments originating outside the United States, a legible copy of a rated, 'on-board' commercial ocean bill-of-lading in English for each shipment of cargo described in paragraph (b)(1) of this section to both the Contracting Officer (through the prime contractor in the case of subcontractor bills-of-lading) and to the Office of Cargo and Commercial Sealift (MAR-620), Maritime Administration, Washington, DC 20590. (MARAD requires copies of the ocean carrier's (master) bills of lading, certified onboard, dated, with rates and charges. These bills of lading may contain business sensitive information and therefore may be submitted directly to MARAD by the Ocean Transportation Intermediary on behalf of the contractor). 46 CFR 381.7.

**ATTACHMENT A - EMPLOYMENT AND MATERIALS
PREFERENCE FOR APPALACHIAN DEVELOPMENT
HIGHWAY SYSTEM OR APPALACHIAN LOCAL ACCESS
ROAD CONTRACTS (23 CFR 633, Subpart B, Appendix B)**

This provision is applicable to all Federal-aid projects funded under the Appalachian Regional Development Act of 1965.

1. During the performance of this contract, the contractor undertaking to do work which is, or reasonably may be, done as on-site work, shall give preference to qualified persons who regularly reside in the labor area as designated by the DOL wherein the contract work is situated, or the subregion, or the Appalachian counties of the State wherein the contract work is situated, except:

a. To the extent that qualified persons regularly residing in the area are not available.

b. For the reasonable needs of the contractor to employ supervisory or specially experienced personnel necessary to assure an efficient execution of the contract work.

c. For the obligation of the contractor to offer employment to present or former employees as the result of a lawful collective bargaining contract, provided that the number of nonresident persons employed under this subparagraph (1c) shall not exceed 20 percent of the total number of employees employed by the contractor on the contract work, except as provided in subparagraph (4) below.

2. The contractor shall place a job order with the State Employment Service indicating (a) the classifications of the laborers, mechanics and other employees required to perform the contract work, (b) the number of employees required in each classification, (c) the date on which the participant estimates such employees will be required, and (d) any other pertinent information required by the State Employment Service to complete the job order form. The job order may be placed with the State Employment Service in writing or by telephone. If during the course of the contract work, the information submitted by the contractor in the original job order is substantially modified, the participant shall promptly notify the State Employment Service.

3. The contractor shall give full consideration to all qualified job applicants referred to him by the State Employment Service. The contractor is not required to grant employment to any job applicants who, in his opinion, are not qualified to perform the classification of work required.

4. If, within one week following the placing of a job order by the contractor with the State Employment Service, the State Employment Service is unable to refer any qualified job applicants to the contractor, or less than the number requested, the State Employment Service will forward a certificate to the contractor indicating the unavailability of applicants. Such certificate shall be made a part of the contractor's permanent project records. Upon receipt of this certificate, the contractor may employ persons who do not normally reside in the labor area to fill positions covered by the certificate, notwithstanding the provisions of subparagraph (1c) above.

5. The provisions of 23 CFR 633.207(e) allow the contracting agency to provide a contractual preference for the use of mineral resource materials native to the Appalachian region.

6. The contractor shall include the provisions of Sections 1 through 4 of this Attachment A in every subcontract for work which is, or reasonably may be, done as on-site work.

NON-DISCRIMINATION PROVISIONS

During the performance of this contract, the contractor, for itself, its assignees, and successors in interest (hereinafter referred to as the "contractor") agrees as follows:

1. Compliance with Regulations: The contractor (hereinafter includes consultants) will comply with the Acts and the Regulations relative to Non-discrimination in Federally-assisted programs of the U.S. Department of Transportation, Federal Highway Administration, as they may be amended from time to time, which are herein incorporated by reference and made a part of this contract.

2. Non-discrimination: The contractor, with regard to the work performed by it during the contract, will not discriminate on the grounds of race, color, or national origin in the selection and retention of subcontractors, including procurements of materials and leases of equipment. The contractor will not participate directly or indirectly in the discrimination prohibited by the Acts and the Regulations, including employment practices when the contract covers any activity, project, or program set forth in Appendix B of 49 CFR Part 21.

3. Solicitations for Subcontracts, Including Procurements of Materials and Equipment: In all solicitations, either by competitive bidding, or negotiation made by the contractor for work to be performed under a subcontract, including procurements of materials, or leases of equipment, each potential subcontractor or supplier will be notified by the contractor of the contractor's obligations under this contract and the Acts and the Regulations relative to Non-discrimination on the grounds of race, color, or national origin.

4. Information and Reports: The contractor will provide all information and reports required by the Acts, the Regulations, and directives issued pursuant thereto and will permit access to its books, records, accounts, other sources of information, and its facilities as may be determined by the Recipient or the Federal Highway Administration to be pertinent to ascertain compliance with such Acts, Regulations, and instructions. Where any information required of a contractor is in the exclusive possession of another who fails or refuses to furnish the information, the contractor will so certify to the Recipient or the Federal Highway Administration, as appropriate, and will set forth what efforts it has made to obtain the information.

5. Sanctions for Noncompliance: In the event of a contractor's noncompliance with the Non-discrimination provisions of this contract, the Recipient will impose such contract sanctions as it or the Federal Highway Administration may determine to be appropriate, including, but not limited to:

- a. Withholding payments to the contractor under the contract until the contractor complies; and/or
- b. Cancelling, terminating, or suspending a contract, in whole or in part.

6. Incorporation of Provisions: The contractor will include the provisions of paragraphs one through six in every subcontract, including procurements of materials and leases of equipment, unless exempt by the Acts, the Regulations and directives issued pursuant thereto. The contractor will take action with respect to any subcontract or procurement as the Recipient or the Federal Highway Administration may direct as a means of enforcing such provisions including sanctions for noncompliance. Provided, that if the contractor becomes involved in, or is threatened with litigation by a subcontractor, or supplier because of such direction, the contractor may request the Recipient to enter into any litigation to protect the interests of the Recipient. In addition, the contractor may request the United States to enter into the litigation to protect the interests of the United States.

During the performance of this contract, the contractor, for itself, its assignees, and successors in interest (hereinafter referred to as the "contractor") agrees to comply with the following non-discrimination statutes and authorities; including but not limited to:

Pertinent Non-Discrimination Authorities:

- Title VI of the Civil Rights Act of 1964 (42 U.S.C. § 2000d et seq., 78 stat. 252), (prohibits discrimination on the basis of race, color, national origin); and 49 CFR Part 21.
- The Uniform Relocation Assistance and Real Property Acquisition Policies Act of 1970, (42 U.S.C. § 4601), (prohibits unfair treatment of persons displaced or whose property has been acquired because of Federal or Federal-aid programs and projects);
- Federal-Aid Highway Act of 1973, (23 U.S.C. § 324 et seq.), (prohibits discrimination on the basis of sex);
- Section 504 of the Rehabilitation Act of 1973, (29 U.S.C. § 794 et seq.), as amended, (prohibits discrimination on the basis of disability); and 49 CFR Part 27;
- The Age Discrimination Act of 1975, as amended, (42 U.S.C. § 6101 et seq.), (prohibits discrimination on the basis of age);
- Airport and Airway Improvement Act of 1982, (49 USC § 471, Section 47123), as amended, (prohibits discrimination based on race, creed, color, national origin, or sex);
- The Civil Rights Restoration Act of 1987, (PL 100-209), (Broadened the scope, coverage and applicability of Title VI of the Civil Rights Act of 1964, The Age Discrimination Act of 1975 and Section 504 of the Rehabilitation Act of 1973, by expanding the definition of the terms "programs or activities" to include all of the programs or activities of the Federal-aid recipients, sub-recipients and contractors, whether such programs or activities are Federally funded or not);
- Titles II and III of the Americans with Disabilities Act, which prohibit discrimination on the basis of disability in the operation of public entities, public and private transportation systems, places of public accommodation, and certain testing entities (42 U.S.C. §§ 12131-12189) as implemented by Department of Transportation regulations at 49 C.F.R. parts 37 and 38;
- The Federal Aviation Administration's Non-discrimination statute (49 U.S.C. § 47123) (prohibits discrimination on the basis of race, color, national origin, and sex);
- Executive Order 12898, Federal Actions to Address Environmental Justice in Minority Populations and Low-Income Populations, which ensures Non-discrimination against minority populations by discouraging programs, policies, and activities with disproportionately high and adverse human health or environmental effects on minority and low-income populations;
- Executive Order 13166, Improving Access to Services for Persons with Limited English Proficiency, and resulting agency guidance, national origin discrimination includes discrimination because of Limited English proficiency (LEP). To ensure compliance with Title VI, you must take reasonable steps to ensure that LEP persons have meaningful access to your programs (70 Fed. Reg. at 74087 to 74100);
- Title IX of the Education Amendments of 1972, as amended, which prohibits you from discriminating because of sex in education programs or activities (20 U.S.C. 1681 et seq).

**NOTICE OF REQUIREMENT FOR AFFIRMATIVE ACTION TO
ENSURE EQUAL EMPLOYMENT OPPORTUNITY
(EXECUTIVE ORDER 11246)**

1. The Offeror's or Bidder's attention is called to the "Employment Practices" and "Equal Opportunity Clause" set forth in the Required Contract Provisions, FHWA 1273.
2. The goals and timetables for minority and female participation expressed in percentage terms for the contractor's aggregate work force in each trade, on all construction work in the covered area, are as follows:

Goals for Minority Participation for Each Trade:

<u>County</u>	<u>%</u>	<u>County</u>	<u>%</u>	<u>County</u>	<u>%</u>
Adams	1.7	Iowa	1.7	Polk	2.2
Ashland	1.2	Iron	1.2	Portage	0.6
Barron	0.6	Jackson	0.6	Price	0.6
Bayfield	1.2	Jefferson	7.0	Racine	8.4
Brown	1.3	Juneau	0.6	Richland	1.7
Buffalo	0.6	Kenosha	3.0	Rock	3.1
Burnett	2.2	Kewaunee	1.0	Rusk	0.6
Calumet	0.9	La Crosse	0.9	St. Croix	2.9
Chippewa	0.5	Lafayette	0.5	Sauk	1.7
Clark	0.6	Langlade	0.6	Sawyer	0.6
Columbia	1.7	Lincoln	0.6	Shawano	1.0
Crawford	0.5	Manitowoc	1.0	Sheboygan	7.0
Dane	2.2	Marathon	0.6	Taylor	0.6
Dodge	7.0	Marinette	1.0	Trempealeau	0.6
Door	1.0	Marquette	1.7	Vernon	0.6
Douglas	1.0	Menominee	1.0	Vilas	0.6
Dunn	0.6	Milwaukee	8.0	Walworth	7.0
Eau Claire	0.5	Monroe	0.6	Washburn	0.6
Florence	1.0	Oconto	1.0	Washington	8.0
Fond du Lac	1.0	Oneida	0.6	Waukesha	8.0
Forest	1.0	Outagamie	0.9	Waupaca	1.0
Grant	0.5	Ozaukee	8.0	Waushara	1.0
Green	1.7	Pepin	0.6	Winnebago	0.9
Green Lake	1.0	Pierce	2.2	Wood	0.6

Goals for female participation for each trade: 6.9%

These goals are applicable to all the contractor's construction work, (whether or not it is federal or federally assisted), performed in the covered area. If the contractor performs construction work in the geographical area located outside of the covered area, it shall apply the goals established for such geographical area where the work is actually performed. With regard to this second area, the contractor also is subject to the goals for both its federally involved and nonfederally involved construction.

The contractor's compliance with the Executive Order and the Regulations in 41 CFR Part 60-4 shall be based on its implementation of the Equal Opportunity Clause, specific affirmative action obligations required by the specifications set forth in 41 CFR 60-4.3(a), and its efforts to meet the goals. The hours of minority and female employment and training must be substantially uniform throughout the length of the contract, and in each trade, and the contractor shall make a good faith effort to employ minorities and women evenly on each of its projects. The transfer of minority or female employees or trainees from contractor to contractor or from project to project for the sole purpose of meeting the contractor's goals shall be a violation of the contract, the Executive Order and the Regulations in 41 CFR Part 60-4. Compliance with the goals will be measured against the total work hours performed.

3. The contractor shall provide written notification to the Director of the Office of Federal Contract Compliance Programs within ten (10) working days of award of any construction subcontract in excess of \$10,000.00 at any tier for construction work under the contract resulting from this solicitation. The notification shall list the name, address and telephone number of the subcontractor, employer identification number of the subcontractor; estimated dollar amount of the subcontract; estimated starting and completion dates of the subcontract; and the geographical area in which the subcontract is to be performed.

As referred to in this section, the Director means:

Director
Office of Federal Contract Compliance Programs
Ruess Federal Plaza
310 W. Wisconsin Ave., Suite 1115
Milwaukee, WI 53202

The "Employer Identification Number" means the Federal Social Security number used on the Employer's Quarterly Federal Tax Return, U.S. Treasury Department Form 941.

4. As used in this notice, and in the contract resulting from solicitation, the "covered area" is the county(ies) in Wisconsin to which this proposal applies.

ADDITIONAL FEDERAL-AID PROVISIONS

NOTICE TO ALL BIDDERS

To report bid rigging activities call:

1-800-424-9071

The U.S. Department of Transportation (DOT) operates the above toll-free "hotline" Monday through Friday, 8:00 a.m. to 5:00 p.m., Eastern Time. Anyone with knowledge of possible bid rigging, bidding collusion, or other fraudulent activities should use the "hotline" to report such activities.

The "hotline" is part of the DOT's continuing effort to identify and investigate highway construction contract fraud and abuse and is operated under the direction of the DOT Inspector General. All information will be treated confidentially and caller anonymity will be respected.

BUY AMERICA PROVISION

Buy America (as documented in M-22-11 from the Office of Management and Budget: <https://www.whitehouse.gov/wp-content/uploads/2022/04/M-22-11.pdf>) shall be domestic products and permanently incorporated in this project as classified in the following three categories, and as noted in the Construction and Materials Manual (CMM):

1. Iron and Steel

All iron and steel manufacturing and coating processes (from smelting forward in the manufacturing process) must have occurred within the United States. Coating includes epoxy coating, galvanizing, painting and any other coating that protects or enhances the value of a material subject to the requirements of Buy America.

The exemption of the iron and steel manufacturing and coating processes Buy America requirement is the minimal use of foreign materials if the total cost of such material permanently incorporated in the product does not exceed one-tenth of one percent (1/10 of 1%) of the total contract cost or \$2,500.00, whichever is greater. For purposes of this paragraph, the cost is that shown to be the value of the subject products as they are delivered to the project.

2. Manufactured Product

All manufactured products (as defined in CMM 228.5) are covered under a previous waiver from 1983, and are currently exempt from Buy America.

3. Construction Material

All construction materials (as defined in OMB M-22-11 and as referenced in CMM 228.5) must comply with Buy America. No exemptions (0.0%) are allowed.

The contractor shall take actions and provide documentation conforming to CMM 228.5 to ensure compliance with this Buy America provision.

<https://wisconsin.gov/rdwy/cmm/cm-02-28.pdf>

Upon completion of the project, certify to the engineer, in writing using department form DT4567 that all iron and steel, manufactured products, and construction materials conform to this Buy America provision.

Form DT4567 is available at: <https://wisconsin.gov/Documents/formdocs/dt4567.docx>

Attach a list of iron or steel exemptions and their associated costs to the certification form.

CARGO PREFERENCE ACT REQUIREMENT

All Federal-aid projects shall comply with 46 CFR 381.7 (a) – (b) as follows:

(a) *Agreement Clauses.* “Use of United States-flag vessels:”

(1) Pursuant to Pub. L. 664 (43 U.S.C. 1241(b)) at least 50 percent of any equipment, materials or commodities procured, contracted for or otherwise obtained with funds granted, guaranteed, loaned, or advanced by the U.S. Government under this agreement, and which may be transported by ocean vessel, shall be transported on privately owned United States-flag commercial vessels, if available.

(2) Within 20 days following the date of loading for shipments originating within the United States or within 30 working days following the date of loading for shipments originating outside the United States, a legible copy of a rated, ‘on-board’ commercial ocean bill-of-lading in English for each shipment of cargo described in paragraph (a)(1) of this section shall be furnished to both the Contracting Officer (through the prime contractor in the case of subcontractor bills-of-lading) and to the Division of National Cargo, Office of Market Development, Maritime Administration, Washington, DC 20590.”

(b) *Contractor and Subcontractor Clauses.* “Use of United States-flag vessels: The contractor agrees—”

(1) To utilize privately owned United States-flag commercial vessels to ship at least 50 percent of the gross tonnage (computed separately for dry bulk carriers, dry cargo liners, and tankers) involved, whenever shipping any equipment, material, or commodities pursuant to this contract, to the extent such vessels are available at fair and reasonable rates for United States-flag commercial vessels.

(2) To furnish within 20 days following the date of loading for shipments originating within the United States or within 30 working days following the date of loading for shipments originating outside the United States, a legible copy of a rated, ‘on-board’ commercial ocean bill-of-lading in English for each shipment of cargo described in paragraph (b) (1) of this section to both the Contracting Officer (through the prime contractor in the case of subcontractor bills-of-lading) and to the Division of National Cargo, Office of Market Development, Maritime Administration, Washington, DC 20590.

(3) To insert the substance of the provisions of this clause in all subcontracts issued pursuant to this contract.

**WISCONSIN DEPARTMENT OF TRANSPORTATION
DIVISION OF TRANSPORTATION AND SYSTEM DEVELOPMENT**

**SUPPLEMENTAL REQUIRED CONTRACT PROVISIONS
FOR PROJECTS WITH FEDERAL AID**

I. PREVAILING WAGE RATES

The attached U.S. Department of Labor (Davis-Bacon Minimum Wage Rates) furnishes the minimum prevailing wage rates pursuant to the Davis-Bacon and Related Acts. The wage rates shown are the minimum rates required by the contract to be paid during its life, however this is not a representation that labor can be obtained at these rates. It is the responsibility of bidders to inform themselves as to the local labor conditions and prospective changes or adjustments of wage rates. No increase in the contract price will be allowed or authorized on account of the payment of wage rates in excess of those listed herein.

II. COVERAGE OF TRUCK DRIVERS

Truck drivers are covered by Davis-Bacon Minimum Wage Rates in the following circumstances:

- Drivers of a contractor or subcontractor for time spent working on the site of the work.
- Drivers of a contractor or subcontractor for time spent loading and/or unloading materials and supplies on the site of the work, if such time is not de minimis.
https://www.dol.gov/whd/FOH/FOH_Ch15.pdf
- Truck drivers transporting materials or supplies between a facility that is deemed part of the site of the work and the actual construction site.
- Truck drivers transporting portions of the building or work between a site established specifically for the performance of the contract where a significant portion of such building or work is constructed and the physical place where the building or work called for in the contract will remain.

Truck drivers are not covered by Davis-Bacon Minimum Wage Rates in the following circumstances:

- Material delivery truck drivers while off the site of the work.
- Drivers of a contractor or subcontractor traveling between a Davis-Bacon job and a commercial supply facility while they are off the site of the work.”
- Truck drivers whose time spent on the site of the work is de minimis, such as only a few minutes at a time merely to pick up or drop off materials or supplies.

Details are available online at:

<https://www.dol.gov/whd/recovery/pwrb/Tab9.pdf>

<https://wisconsindot.gov/Pages/doing-bus/civil-rights/labornwage/trckng.aspx>

III. POSTINGS AT THE SITE OF THE WORK

In addition to the required postings furnished by the department, the contractor shall post the following in at least one conspicuous and accessible place at the site of work:

- a. A copy of the contractor's Equal Employment Opportunity Policy.

All required documents shall be posted by the first day of work and be accurate and complete. Postings must be readable, in an area where they will be noticed, and maintained until the last day of work.

IV. RESOURCES

Required information regarding compliance with federal provisions is found in the following resources:

- FHWA-1273 included in this contract
- U.S. Department of Labor Prevailing Wage Resource Book
- U.S. Department of Labor Field Operations Handbook
- U.S. Code of Federal Regulations
- Any applicable law, Act, or Executive Order enacted by the federal government at the time of the letting of this contract

Superseded General Decision Number: WI20210010

State: Wisconsin

Construction Type: Highway

Counties: Wisconsin Statewide.

HIGHWAY, AIRPORT RUNWAY & TAXIWAY CONSTRUCTION PROJECTS (does not include bridges over navigable waters; tunnels; buildings in highway rest areas; and railroad construction)

Note: Contracts subject to the Davis-Bacon Act are generally required to pay at least the applicable minimum wage rate required under Executive Order 14026 or Executive Order 13658. Please note that these Executive Orders apply to covered contracts entered into by the federal government that are subject to the Davis-Bacon Act itself, but do not apply to contracts subject only to the Davis-Bacon Related Acts, including those set forth at 29 CFR 5.1(a)(2)-(60).

If the contract is entered into on or after January 30, 2022, or the contract is renewed or extended (e.g., an option is exercised) on or after January 30, 2022:	. Executive Order 14026 generally applies to the contract. . The contractor must pay all covered workers at least \$15.00 per hour (or the applicable wage rate listed on this wage determination, if it is higher) for all hours spent performing on the contract in 2022.
If the contract was awarded on or between January 1, 2015 and January 29, 2022, and the contract is not renewed or extended on or after January 30, 2022:	. Executive Order 13658 generally applies to the contract. . The contractor must pay all covered workers at least \$11.25 per hour (or the applicable wage rate listed on this wage determination, if it is higher) for all hours spent performing on that contract in 2022.

The applicable Executive Order minimum wage rate will be adjusted annually. If this contract is covered by one of the Executive Orders and a classification considered necessary for performance of work on the contract does not appear on this wage determination, the contractor must still submit a conformance request.

Additional information on contractor requirements and worker protections under the Executive Orders is available at <https://www.dol.gov/agencies/whd/government-contracts>.

1	01/21/2022
2	02/04/2022
3	02/25/2022
4	03/11/2022
5	03/18/2022
6	04/29/2022
7	05/13/2022
8	06/17/2022
9	07/08/2022
10	07/22/2022
11	07/29/2022
12	08/12/2022
13	09/16/2022
14	10/14/2022

BRWI0001-002 06/01/2021

CRAWFORD, JACKSON, JUNEAU, LA CROSSE, MONROE, TREMPLEAU, AND VERNON COUNTIES

	Rates	Fringes
BRICKLAYER.....	\$ 36.81	25.17

BRWI0002-002 06/01/2021

ASHLAND, BAYFIELD, DOUGLAS, AND IRON COUNTIES

	Rates	Fringes
BRICKLAYER.....	\$ 44.35	23.89

BRWI0002-005 06/01/2021

ADAMS, ASHLAND, BARRON, BROWN, BURNETT, CALUMET, CHIPPEWA, CLARK, COLUMBIA, DODGE, DOOR, DUNN, FLORENCE, FOND DU LAC, FOREST, GREEN LAKE, IRON, JEFFERSON, KEWAUNEE, LANGLADE, LINCOLN, MANITOWOC, MARATHON, MARINETTE, MARQUETTE, MENOMINEE, OCONTO, ONEIDA, OUTAGAMIE, POLK, PORTAGE, RUSK, ST CROIX, SAUK, SHAWANO, SHEBOYGAN, TAYLOR, VILAS, WALWORTH, WAUPACA, WAUSHARA, WINNEBAGO, AND WOOD COUNTIES

	Rates	Fringes
CEMENT MASON/CONCRETE FINISHER...	\$ 37.73	24.15

BRWI0003-002 06/01/2021

BROWN, DOOR, FLORENCE, KEWAUNEE, MARINETTE, AND OCONTO COUNTIES

	Rates	Fringes
BRICKLAYER.....	\$ 37.03	24.95

BRWI0004-002 06/01/2021

KENOSHA, RACINE, AND WALWORTH COUNTIES

	Rates	Fringes
BRICKLAYER.....	\$ 41.30	26.03

BRWI0006-002 06/01/2021

ADAMS, CLARK, FOREST, LANGLADE, LINCOLN, MARATHON, MENOMINEE,
ONEIDA, PORTAGE, PRICE, TAYLOR, VILAS AND WOOD COUNTIES

	Rates	Fringes
BRICKLAYER.....	\$ 37.78	24.20

BRWI0007-002 06/01/2021		

GREEN, LAFAYETTE, AND ROCK COUNTIES

	Rates	Fringes
BRICKLAYER.....	\$ 38.38	25.31

BRWI0008-002 06/01/2021		

MILWAUKEE, OZAUKEE, WASHINGTON, AND WAUKESHA COUNTIES

	Rates	Fringes
BRICKLAYER.....	\$ 42.38	24.64

BRWI0011-002 06/01/2021		

CALUMET, FOND DU LAC, MANITOWOC, AND SHEBOYGAN COUNTIES

	Rates	Fringes
BRICKLAYER.....	\$ 37.03	24.95

BRWI0019-002 06/01/2021		

BARRON, BUFFALO, BURNETT, CHIPPEWA, DUNN, EAU CLAIRE, PEPIN,
PIERCE, POLK, RUSK, ST. CROIX, SAWYER AND WASHBURN COUNTIES

	Rates	Fringes
BRICKLAYER.....	\$ 36.31	25.67

BRWI0034-002 06/01/2021		

COLUMBIA AND SAUK COUNTIES

	Rates	Fringes
BRICKLAYER.....	\$ 38.53	25.16

* CARP0068-011 05/02/2022		

BURNETT (W. of Hwy 48), PIERCE (W. of Hwy 29), POLK (W. of Hwys
35, 48 & 65), AND ST. CROIX (W. of Hwy 65) COUNTIES

	Rates	Fringes
Carpenter & Piledrivermen.....	\$ 41.19	27.05

CARP0252-002 06/01/2016		

ADAMS, BARRON, BAYFIELD (Eastern 2/3), BROWN, BUFFALO,
BURNETT (E. of Hwy 48), CALUMET, CHIPPEWA, CLARK, COLUMBIA,

CRAWFORD, DANE, DODGE, DOOR, DUNN, EAU CLAIRE, FLORENCE (except area bordering Michigan State Line), FOND DU LAC, FOREST, GRANT, GREEN, GREEN LAKE, IOWA, IRON, JACKSON, JEFFERSON, JUNEAU, KEWAUNEE, LA CROSSE, LAFAYETTE, LANGLADE, LINCOLN, MANITOWOC, MARATHON, MARINETTE (except N.E. corner), MARQUETTE, MENOMINEE, MONROE, OCONTO, ONEIDA, OUTAGAMIE, PEPIN, PIERCE (E. of Hwys 29 & 65), POLK (E. of Hwys 35, 48 & 65), PORTAGE, PRICE, RICHLAND, ROCK, RUSK, SAUK, SAWYER, SHAWANO, SHEBOYGAN, ST CROIX (E. of Hwy 65), TAYLOR, TREMPLEAU, VERNON, VILAS, WALWORTH, WASHBURN, WAUPACA, WAUSHARA, WINNEBAGO, AND WOOD COUNTIES

	Rates	Fringes
CARPENTER		
CARPENTER.....	\$ 33.56	18.00
MILLWRIGHT.....	\$ 35.08	18.35
PILEDRIVER.....	\$ 34.12	18.00

CARP0252-010 06/01/2016		

ASHLAND COUNTY

	Rates	Fringes
Carpenters		
Carpenter.....	\$ 33.56	18.00
Millwright.....	\$ 35.08	18.35
Pile Driver.....	\$ 34.12	18.00

CARP0264-003 06/01/2016		

KENOSHA, MILWAUKEE, OZAUKEE, RACINE, WAUKESHA, AND WASHINGTON COUNTIES

	Rates	Fringes
CARPENTER.....	\$ 35.78	22.11

CARP0361-004 05/01/2018		

BAYFIELD (West of Hwy 63) AND DOUGLAS COUNTIES

	Rates	Fringes
CARPENTER.....	\$ 36.15	20.43

CARP2337-001 06/01/2016		

ZONE A: MILWAUKEE, OZAUKEE, WAUKESHA AND WASHINGTON

ZONE B: KENOSHA & RACINE

	Rates	Fringes
PILEDRIVERMAN		
Zone A.....	\$ 31.03	22.69
Zone B.....	\$ 31.03	22.69

ELEC0014-002 05/29/2022		

ASHLAND, BARRON, BAYFIELD, BUFFALO, BURNETT, CHIPPEWA, CLARK

(except Maryville, Colby, Unity, Sherman, Fremont, Lynn & Sherwood), CRAWFORD, DUNN, EAU CLAIRE, GRANT, IRON, JACKSON, LA CROSSE, MONROE, PEPIN, PIERCE, POLK, PRICE, RICHLAND, RUSK, ST CROIX, SAWYER, TAYLOR, TREMPLEAU, VERNON, AND WASHBURN COUNTIES

	Rates	Fringes
Electricians:.....	\$ 38.49	22.09

ELEC0014-007 05/29/2022

REMAINING COUNTIES

	Rates	Fringes
Teledata System Installer.....	\$ 29.63	3%+16.18
Installer/Technician.....	\$ 28.50	15.92

Low voltage construction, installation, maintenance and removal of teledata facilities (voice, data, and video) including outside plant, telephone and data inside wire, interconnect, terminal equipment, central offices, PABX, fiber optic cable and equipment, micro waves, V-SAT, bypass, CATV, WAN (wide area networks), LAN (local area networks), and ISDN (integrated systems digital network).

ELEC0127-002 06/01/2021

KENOSHA COUNTY

	Rates	Fringes
Electricians:.....	\$ 43.16	30%+12.70

ELEC0158-002 05/30/2021

BROWN, DOOR, KEWAUNEE, MANITOWOC (except Schleswig), MARINETTE(Wausaukee and area South thereof), OCONTO, MENOMINEE (East of a line 6 miles West of the West boundary of Oconto County), SHAWANO (Except Area North of Townships of Aniwa and Hutchins) COUNTIES

	Rates	Fringes
ELECTRICIAN.....	\$ 36.14	29.75%+10.26

ELEC0159-003 05/30/2021

COLUMBIA, DANE, DODGE (Area West of Hwy 26, except Chester and Emmet Townships), GREEN, LAKE (except Townships of Berlin, Seneca, and St. Marie), IOWA, MARQUETTE (except Townships of Neshkoka, Crystal Lake, Newton, and Springfield), and SAUK COUNTIES

	Rates	Fringes
ELECTRICIAN.....	\$ 43.38	23.13

ELEC0219-004 06/01/2019

FLORENCE COUNTY (Townships of Aurora, Commonwealth, Fern, Florence and Homestead) AND MARINETTE COUNTY (Township of Niagara)

	Rates	Fringes
Electricians:		
Electrical contracts over \$180,000.....	\$ 33.94	21.80
Electrical contracts under \$180,000.....	\$ 31.75	21.73

ELEC0242-005 05/30/2021		

DOUGLAS COUNTY

	Rates	Fringes
Electricians:.....	\$ 41.37	69.25%

ELEC0388-002 05/30/2021		

ADAMS, CLARK (Colby, Freemont, Lynn, Mayville, Sherman, Sherwood, Unity), FOREST, JUNEAU, LANGLADE, LINCOLN, MARATHON, MARINETTE (Beecher, Dunbar, Goodman & Pembine), MENOMINEE (Area West of a line 6 miles West of the West boundary of Oconto County), ONEIDA, PORTAGE, SHAWANO (Aniwa and Hutchins), VILAS AND WOOD COUNTIES

	Rates	Fringes
Electricians:.....	\$ 36.22	26%+11.24

ELEC0430-002 06/01/2022		

RACINE COUNTY (Except Burlington Township)

	Rates	Fringes
Electricians:.....	\$ 45.02	24.35

ELEC0494-005 06/01/2021		

MILWAUKEE, OZAUKEE, WASHINGTON, AND WAUKESHA COUNTIES

	Rates	Fringes
Electricians:.....	\$ 44.39	25.67

ELEC0494-006 06/01/2021		

CALUMET (Township of New Holstein), DODGE (East of Hwy 26 including Chester Township), FOND DU LAC, MANITOWOC (Schleswig), and SHEBOYGAN COUNTIES

	Rates	Fringes
Electricians:.....	\$ 37.91	22.74

ELEC0494-013 06/01/2021		

DODGE (East of Hwy 26 including Chester Twp, excluding Emmet

Twp), FOND DU LAC (Except Waupun), MILWAUKEE, OZAUKEE,
 MANITOWOC (Schleswig), WASHINGTON, AND WAUKESHA COUNTIES

	Rates	Fringes
Sound & Communications		
Installer.....	\$ 22.39	18.80
Technician.....	\$ 32.49	20.26

Installation, testing, maintenance, operation and servicing of all sound, intercom, telephone interconnect, closed circuit TV systems, radio systems, background music systems, language laboratories, electronic carillon, antenna distribution systems, clock and program systems and low-voltage systems such as visual nurse call, audio/visual nurse call systems, doctors entrance register systems. Includes all wire and cable carrying audio, visual, data, light and radio frequency signals. Includes the installation of conduit, wiremold, or raceways in existing structures that have been occupied for six months or more where required for the protection of the wire or cable, but does not mean a complete conduit or raceway system. work covered does not include the installation of conduit, wiremold or any raceways in any new construction, or the installation of power supply outlets by means of which external electric power is supplied to any of the foregoing equipment or products

 ELEC0577-003 06/01/2021

CALUMET (except Township of New Holstein), GREEN LAKE (N. part including Townships of Berlin, St Marie, and Seneca), MARQUETTE (N. part including Townships of Crystal Lake, Neshkoro, Newton, and Springfield), OUTAGAMIE, WAUPACA, WAUSHARA, AND WINNEBAGO COUNTIES

	Rates	Fringes
Electricians:.....	\$ 35.66	29.50%+10.00

 ELEC0890-003 06/01/2021

DODGE (Emmet Township only), GREEN, JEFFERSON, LAFAYETTE,
 RACINE (Burlington Township), ROCK AND WALWORTH COUNTIES

	Rates	Fringes
Electricians:.....	\$ 39.00	25.95%+11.17

 ELEC0953-001 06/02/2019

	Rates	Fringes
Line Construction:		
(1) Lineman.....	\$ 47.53	21.43
(2) Heavy Equipment Operator.....	\$ 42.78	19.80
(3) Equipment Operator.....	\$ 38.02	18.40
(4) Heavy Groundman Driver..	\$ 33.27	16.88
(5) Light Groundman Driver..	\$ 30.89	16.11
(6) Groundsman.....	\$ 26.14	14.60

	Rates	Fringes
Power Equipment Operator		
Group 1.....	\$ 43.27	25.95
Group 2.....	\$ 42.77	25.95
Group 3.....	\$ 42.27	25.95
Group 4.....	\$ 42.01	25.95
Group 5.....	\$ 41.72	25.95
Group 6.....	\$ 35.82	25.95

HAZARDOUS WASTE PREMIUMS:

EPA Level ""A"" protection - \$3.00 per hour
 EPA Level ""B"" protection - \$2.00 per hour
 EPA Level ""C"" protection - \$1.00 per hour

POWER EQUIPMENT OPERATORS CLASSIFICATIONS

GROUP 1: Cranes, tower cranes, and derricks with or without attachments with a lifting capacity of over 100 tons; or cranes, tower cranes, and derricks with boom, leads and/or jib lengths measuring 176 feet or longer.

GROUP 2: Cranes, tower cranes and derricks with or without attachments with a lifting capacity of 100 tons or less; or cranes, tower cranes, and derricks with boom, leads, and/or jibs lengths measuring 175 feet or under and Backhoes (excavators) weighing 130,000 lbs and over; caisson rigs; pile driver; dredge operator; dredge engineer; Boat Pilot.

GROUP 3: Mechanic or welder - Heavy duty equipment; cranes with a lifting capacity of 25 tons or under; concrete breaker (manual or remote); vibratory/sonic concrete breaker; concrete laser screed; concrete slipform paver; concrete batch plant operator; concrete pvt. spreader - heavy duty (rubber tired); concrete spreader & distributor; automatic subgrader (concrete); concrete grinder & planing machine; concrete slipform curb & gutter machine; slipform concrete placer; tube finisher; hydro blaster (10,000 psi & over); bridge paver; concrete conveyor system; concrete pump; Rotec type Conveyor; stabilizing mixer (self-propelled); shoulder widener; asphalt plant engineer; bituminous paver; bump cutter & grooving machine; milling machine; screed (bituminous paver); asphalt heater, planer & scarifier; Backhoes (excavators) weighing under 130,000 lbs; grader or motor patrol; tractor (scraper, dozer, pusher, loader); scraper - rubber tired (single or twin engine); endloader; hydraulic backhoe (tractor type); trenching machine; skid rigs; tractor, side boom (heavy); drilling or boring machine (mechanical heavy); roller over 5 tons; percussion or rotary drilling machine; air track; blaster; loading machine (conveyor); tugger; boatmen; winches & A-frames; post driver; material hoist.

GROUP 4: Greaser, roller steel (5 tons or less); roller (pneumatic tired) - self propelled; tractor (mounted or towed compactors & light equipment); shouldering machine; self-propelled chip spreader; concrete spreader; finishing machine; mechanical float; curing machine; power subgrader; joint sawer (multiple blade) belting machine; burlap machine; texturing machine; tractor endloader (rubber tired) - light; jeep digger; forklift; mulcher; launch operator; fireman, environmental burner

GROUP 5: Air compressor; power pack; vibrator hammer and extractor; heavy equipment, leadman; tank car heaters; stump chipper; curb machine operator; Concrete proportioning plants; generators; mudjack operator; rock breaker; crusher or screening plant; screed (milling machine); automatic belt conveyor and surge bin; pug mill operator; Oiler, pump (over 3 inches); Drilling Machine Tender, day light machine

GROUP 6: Off-road material hauler with or without ejector.

 IRON0008-002 06/13/2022

BROWN, CALUMET, DOOR, FOND DU LAC, KEWAUNEE, MANITOWOC, MARINETTE, OCONTO, OUTAGAMI, SHAWANO, SHEBOYGAN, AND WINNEBAGO COUNTIES:

	Rates	Fringes
IRONWORKER.....	\$ 41.00	28.95

Paid Holidays: New Year's Day, Memorial Day, July 4th, Labor Day, Thanksgiving Day & Christmas Day.

 IRON0008-003 06/01/2021

KENOSHA, MILWAUKEE, OZAUKEE, RACINE, WALWORTH (N.E. 2/3), WASHINGTON, AND WAUKESHA COUNTIES

	Rates	Fringes
IRONWORKER.....	\$ 40.57	28.40

Paid Holidays: New Year's Day, Memorial Day, July 4th, Labor Day, Thanksgiving Day & Christmas Day.

 IRON0383-001 06/05/2022

ADAMS, COLUMBIA, CRAWFORD, DANE, DODGE, FLORENCE, FOREST, GRANT, GREENE, (Excluding S.E. tip), GREEN LAKE, IOWA, JEFFERSON, JUNEAU, LA CROSSE, LAFAYETTE, LANGLADE, MARATHON, MARQUETTE, MENOMINEE, MONROE, PORTAGE, RICHLAND, ROCK (Northern area, vicinity of Edgerton and Milton), SAUK, VERNON, WAUPACA, WAUSHARA, AND WOOD COUNTIES

	Rates	Fringes
IRONWORKER.....	\$ 39.00	28.58

 IRON0498-005 06/01/2021

GREEN (S.E. 1/3), ROCK (South of Edgerton and Milton), and WALWORTH (S.W. 1/3) COUNTIES:

	Rates	Fringes
IRONWORKER.....	\$ 41.37	44.41

IRON0512-008 05/01/2022

BARRON, BUFFALO, CHIPPEWA, CLARK, DUNN, EAU CLAIRE, JACKSON,
PEPIN, PIERCE, POLK, RUSK, ST CROIX, TAYLOR, AND TREMPPEALEAU
COUNTIES

	Rates	Fringes
IRONWORKER.....	\$ 41.00	33.11

IRON0512-021 05/01/2022

ASHLAND, BAYFIELD, BURNETT, DOUGLAS, IRON, LINCOLN, ONEIDA,
PRICE, SAWYER, VILAS AND WASHBURN COUNTIES

	Rates	Fringes
IRONWORKER.....	\$ 36.94	33.11

LAB00113-002 06/01/2022

MILWAUKEE AND WAUKESHA COUNTIES

	Rates	Fringes
LABORER		
Group 1.....	\$ 32.65	23.09
Group 2.....	\$ 32.80	23.09
Group 3.....	\$ 33.00	23.09
Group 4.....	\$ 33.15	23.09
Group 5.....	\$ 33.30	23.09
Group 6.....	\$ 29.14	23.09

LABORERS CLASSIFICATIONS

GROUP 1: General Laborer; Tree Trimmer; Conduit Layer;
Demolition and Wrecking Laborer; Guard Rail, Fence, and
Bridge Builder; Landscaper; Multiplate Culvert Assembler;
Stone Handler; Bituminous Worker (Shoveler, Loader, and
Utility Man); Batch Truck Dumper or Cement Handler;
Bituminous Worker (Dumper, Ironer, Smoother, and Tamper);
Concrete Handler

GROUP 2: Air Tool Operator; Joint Sawyer and Filler
(Pavement); Vibrator or Tamper Operator (Mechanical Hand
Operated); Chain Saw Operator; Demolition Burning Torch
Laborer

GROUP 3: Bituminous Worker (Raker and Luteman); Formsetter
(Curb, Sidewalk, and Pavement); Strike Off Man

GROUP 4: Line and Grade Specialist

GROUP 5: Blaster and Powderman

GROUP 6: Flagperson; traffic control person

LAB00113-003 06/01/2022

OZAUKEE AND WASHINGTON COUNTIES

	Rates	Fringes
LABORER		
Group 1.....	\$ 31.90	23.09
Group 2.....	\$ 32.00	23.09
Group 3.....	\$ 32.05	23.09
Group 4.....	\$ 32.25	23.09
Group 5.....	\$ 32.10	23.09
Group 6.....	\$ 28.99	23.09

LABORERS CLASSIFICATIONS

GROUP 1: General Laborer; Tree Trimmer; Conduit Layer; Demolition and Wrecking Laborer; Guard Rail, Fence, and Bridge Builder; Landscaper; Multiplate Culvert Assembler; Stone Handler; Bituminous Worker (Shoveler, Loader, and Utility Man); Batch Truck Dumper or Cement Handler; Bituminous Worker (Dumper, Ironer, Smoother, and Tamper); Concrete Handler

GROUP 2: Air Tool Operator; Joint Sawyer and Filler (Pavement); Vibrator or Tamper Operator (Mechanical Hand Operated);

GROUP 3: Bituminous Worker (Raker and Luteman); Formsetter (Curb, Sidewalk, and Pavement); Strike Off Man

GROUP 4: Line and Grade Specialist

GROUP 5: Blaster; powderman

GROUP 6: Flagperson and Traffic Control Person

LAB00113-011 06/01/2022

KENOSHA AND RACINE COUNTIES

	Rates	Fringes
LABORER		
Group 1.....	\$ 31.71	23.09
Group 2.....	\$ 31.86	23.09
Group 3.....	\$ 32.06	23.09
Group 4.....	\$ 32.03	23.09
Group 5.....	\$ 32.36	23.09
Group 6.....	\$ 28.85	23.09

LABORERS CLASSIFICATIONS:

GROUP 1: General laborer; Tree Trimmer; Conduit Layer; Demolition and Wrecking Laborer; Guard Rail, Fence, and Bridge Builder; Landscaper; Multiplate Culvert Assembler; Stone Handler; Bituminous Worker (Shoveler, Loader, and Utility Man); Batch Truck Dumper or Cement Handler; Bituminous worker (Dumper, Ironer, Smoother, and Tamper); Concrete Handler

GROUP 2: Air Tool Operator; Joint Sawyer and Filler (Pavement); Vibrator or Tamper Operator (Mechanical Hand Operated); Chain Saw Operator; Demolition Burning Torch Laborer

GROUP 3: Bituminous Worker (Raker and Luteman); Formsetter (Curb, Sidewalk, and Pavement); Strike Off Man

GROUP 4: Line and Grade Specialist

GROUP 5: Blaster and Powderman

GROUP 6: Flagman; traffic control person

LAB00140-002 06/01/2022

ADAMS, ASHLAND, BARRON, BAYFIELD, BROWN, BUFFALO, BURNETT, CALUMET, CHIPPEWA, CLARK, COLUMBIA, CRAWFORD, DODGE, DOOR, DOUGLAS, DUNN, EAU CLAIRE, FLORENCE, FOND DU LAC, FOREST, GRANT, GREEN, GREEN LAKE, IRON, JACKSON, JUNEAU, IOWA, JEFFERSON, KEWAUNEE, LA CROSSE, LAFAYETTE, LANGLADE, LINCOLN, MANITOWOC, MARATHON, MARINETTE, MARQUETTE, MENOMINEE, MONROE, OCONTO, ONEIDA, OUTAGAMIE, PEPIN, PIERCE, POLK, PORTAGE, PRICE, RICHLAND, ROCK, RUSK, SAUK, SAWYER, SHAWANO, SHEBOYGAN, ST. CROIX, TAYLOR, TREMPLEAU, VERNON, VILLAS, WALWORTH, WASHBURN, WAUPACA, WAUSHARA, WINNEBAGO, AND WOOD COUNTIES

	Rates	Fringes
LABORER		
Group 1.....	\$ 36.42	18.68
Group 2.....	\$ 36.52	18.68
Group 3.....	\$ 36.57	18.68
Group 4.....	\$ 36.77	18.68
Group 5.....	\$ 36.62	18.68
Group 6.....	\$ 33.05	18.68

LABORER CLASSIFICATIONS

GROUP 1: General Laborer; Tree Trimmer; Conduit Layer; Demolition and Wrecking Laborer; Guard Rail, Fence, and Bridge Builder; Landscaper; Multiplate Culvert Assembler; Stone Handler; Bituminous Worker (Shoveler, Loader, and Utility Man); Batch Truck Dumper or Cement Handler; Bituminous Worker (Dumper, Ironer, Smoother and Tamper); Concrete Handler

GROUP 2: Air Tool Operator; Joint Sawyer and Filler (Pavement); Vibrator or Tamper Operator (Mechanical Hand Operated); Chain Saw Operator, Demolition Burning Torch Laborer

GROUP 3: Bituminous Worker (Raker and Luteman); Formsetter (Curb, Sidewalk and Pavement); Strike Off Man

GROUP 4: Line and Grade Specialist

GROUP 5: Blaster; powderman

GROUP 6: Flagperson; Traffic Control

LAB00464-003 06/01/2022

DANE COUNTY

	Rates	Fringes
LABORER		
Group 1.....	\$ 36.70	18.68

Group 2.....	\$ 36.80	18.68
Group 3.....	\$ 36.85	18.68
Group 4.....	\$ 37.05	18.68
Group 5.....	\$ 36.90	18.68
Group 6.....	\$ 33.05	18.68

LABORERS CLASSIFICATIONS:

GROUP 1: General Laborer; Tree Trimmer; Conduit Layer; Demolition and Wrecking Laborer; Guard Rail, Fence, and Bridge Builder; Landscaper; Multiplate Culvert Assembler; Stone Handler; Bituminous Worker (Shoveler, Loader, and Utility Man); Batch Truck Dumper or Cement Handler; Bituminous Worker (Dumper, Ironer, Smoother, and Tamper); Concrete Handler

GROUP 2: Air Tool Operator; Joint Sawyer and Filler (Pavement); Vibrator or Tamper Operator (Mechanical Hand Operated); Chain Saw Operator; Demolition Burning Torch Laborer

GROUP 3: Bituminous Worker (Raker and Luteman); Formsetter (Curb, Sidewalk, and Pavement); Strike Off Man

GROUP 4: Line and Grade Specialist

GROUP 5: Blaster; Powderman

GROUP 6: Flagperson and Traffic Control Person

PAIN0106-008 05/01/2022

ASHLAND, BAYFIELD, BURNETT, AND DOUGLAS COUNTIES

	Rates	Fringes
Painters:		
New:		
Brush, Roller.....	\$ 33.99	22.70
Spray, Sandblast, Steel....	\$ 34.59	22.70
Repaint:		
Brush, Roller.....	\$ 33.09	22.70
Spray, Sandblast, Steel....	\$ 32.49	22.70

* PAIN0108-002 06/01/2022

RACINE COUNTY

	Rates	Fringes
Painters:		
Brush, Roller.....	\$ 39.60	21.79
Spray & Sandblast.....	\$ 40.60	21.79

PAIN0259-002 05/01/2008

BARRON, CHIPPEWA, DUNN, EAU CLAIRE, PEPIN, PIERCE, POLK, RUSK, SAWYER, ST. CROIX, AND WASHBURN COUNTIES

	Rates	Fringes
PAINTER.....	\$ 24.11	12.15

PAIN0259-004 05/01/2015

BUFFALO, CRAWFORD, JACKSON, LA CROSSE, MONROE, TREMPLEAU, AND VERNON COUNTIES

	Rates	Fringes
PAINTER.....	\$ 22.03	12.45

* PAIN0781-002 06/01/2022

JEFFERSON, MILWAUKEE, OZAUKEE, WASHINGTON, AND WAUKESHA COUNTIES

	Rates	Fringes
Painters:		
Bridge.....	\$ 38.15	24.80
Brush.....	\$ 37.40	24.80
Spray & Sandblast.....	\$ 38.15	24.80

PAIN0802-002 06/01/2021

COLUMBIA, DANE, DODGE, GRANT, GREEN, IOWA, LAFAYETTE, RICHLAND, ROCK, AND SAUK COUNTIES

	Rates	Fringes
PAINTER		
Brush.....	\$ 29.98	18.78

PREMIUM PAY:

Structural Steel, Spray, Bridges = \$1.00 additional per hour.

PAIN0802-003 06/01/2021

ADAMS, BROWN, CALUMET, CLARK, DOOR, FOND DU LAC, FOREST, GREEN LAKE, IRON, JUNEAU, KEWAUNEE, LANGLADE, LINCOLN, MANITOWOC, MARATHON, MARINETTE, MARQUETTE, MENOMINEE, OCONTO, ONEIDA, OUTAGAMIE, PORTAGE, PRICE, SHAWANO, SHEBOYGAN, TAYLOR, VILAS, WAUSHARA, WAUPACA, WINNEBAGO, AND WOOD COUNTIES

	Rates	Fringes
PAINTER.....	\$ 29.98	18.78

* PAIN0934-001 06/01/2022

KENOSHA AND WALWORTH COUNTIES

	Rates	Fringes
Painters:		
Brush.....	\$ 36.70	24.69
Spray.....	\$ 37.70	24.69
Structural Steel.....	\$ 36.85	24.69

PAIN1011-002 06/06/2021

FLORENCE COUNTY

	Rates	Fringes
Painters:.....	\$ 26.71	14.38

PLAS0599-010 06/01/2021		

	Rates	Fringes
CEMENT MASON/CONCRETE FINISHER		
Area 1.....	\$ 42.06	20.87
Area 2 (BAC).....	\$ 37.73	23.80
Area 3.....	\$ 38.74	22.46
Area 4.....	\$ 38.59	22.66
Area 5.....	\$ 38.16	22.98
Area 6.....	\$ 34.94	26.36

AREA DESCRIPTIONS

AREA 1: BAYFIELD, DOUGLAS, PRICE, SAWYER, AND WASHBURN COUNTIES

AREA 2: ADAMS, ASHLAND, BARRON, BROWN, BURNETT, CALUMET, CHIPPEWA, CLARK, COLUMBIA, DODGE, DOOR, DUNN, FLORENCE, FOND DU LAC, FOREST, GREEN LAKE, IRON, JEFFERSON, KEWAUNEE, LANGLADE, LINCOLN, MANITOWOC, MARATHON, MARINETTE, MARQUETTE, MENOMINEE, OCONTO, ONEIDA, OUTAGAMIE, POLK, PORTAGE, RUSK, ST CROIX, SAUK, SHAWANO, SHEBOYGAN, TAYLOR, VILAS, WALWORTH, WAUPACA, WAUSHARA, WINNEBAGO, AND WOOD COUNTIES

AREA 3: BUFFALO, CRAWFORD, EAU CLAIRE, JACKSON, JUNEAU, LA CROSSE MONROE, PEPIN, PIERCE, RICHLAND, TREMPLEAU, AND VERNON COUNTIES

AREA 4: MILWAUKEE, OZAUKEE, WASHINGTON, AND WAUKESHA COUNTIES

AREA 5: DANE, GRANT, GREEN, IOWA, LAFAYETTE, AND ROCK COUNTIES

AREA 6: KENOSHA AND RACINE COUNTIES

TEAM0039-001 06/01/2021		

	Rates	Fringes
TRUCK DRIVER		
1 & 2 Axles.....	\$ 32.57	23.81
3 or more Axles; Euclids, Dumpton & Articulated, Truck Mechanic.....	\$ 32.72	23.81

WELL DRILLER.....	\$ 16.52	3.70

WELDERS - Receive rate prescribed for craft performing operation to which welding is incidental.

=====

Note: Executive Order (EO) 13706, Establishing Paid Sick Leave for Federal Contractors applies to all contracts subject to the Davis-Bacon Act for which the contract is awarded (and any solicitation was issued) on or after January 1, 2017. If this

contract is covered by the EO, the contractor must provide employees with 1 hour of paid sick leave for every 30 hours they work, up to 56 hours of paid sick leave each year. Employees must be permitted to use paid sick leave for their own illness, injury or other health-related needs, including preventive care; to assist a family member (or person who is like family to the employee) who is ill, injured, or has other health-related needs, including preventive care; or for reasons resulting from, or to assist a family member (or person who is like family to the employee) who is a victim of, domestic violence, sexual assault, or stalking. Additional information on contractor requirements and worker protections under the EO is available at <https://www.dol.gov/agencies/whd/government-contracts>.

Unlisted classifications needed for work not included within the scope of the classifications listed may be added after award only as provided in the labor standards contract clauses (29CFR 5.5 (a) (1) (ii)).

The body of each wage determination lists the classification and wage rates that have been found to be prevailing for the cited type(s) of construction in the area covered by the wage determination. The classifications are listed in alphabetical order of ""identifiers"" that indicate whether the particular rate is a union rate (current union negotiated rate for local), a survey rate (weighted average rate) or a union average rate (weighted union average rate).

Union Rate Identifiers

A four letter classification abbreviation identifier enclosed in dotted lines beginning with characters other than ""SU"" or ""UAVG"" denotes that the union classification and rate were prevailing for that classification in the survey. Example: PLUM0198-005 07/01/2014. PLUM is an abbreviation identifier of the union which prevailed in the survey for this classification, which in this example would be Plumbers. 0198 indicates the local union number or district council number where applicable, i.e., Plumbers Local 0198. The next number, 005 in the example, is an internal number used in processing the wage determination. 07/01/2014 is the effective date of the most current negotiated rate, which in this example is July 1, 2014.

Union prevailing wage rates are updated to reflect all rate changes in the collective bargaining agreement (CBA) governing this classification and rate.

Survey Rate Identifiers

Classifications listed under the ""SU"" identifier indicate that no one rate prevailed for this classification in the survey and the published rate is derived by computing a weighted average rate based on all the rates reported in the survey for that classification. As this weighted average rate includes all rates reported in the survey, it may include both union and non-union rates. Example: SULA2012-007 5/13/2014. SU indicates the rates are survey rates based on a weighted average calculation of rates and are not majority rates. LA indicates the State of Louisiana. 2012 is the year of survey on which

these classifications and rates are based. The next number, 007 in the example, is an internal number used in producing the wage determination. 5/13/2014 indicates the survey completion date for the classifications and rates under that identifier.

Survey wage rates are not updated and remain in effect until a new survey is conducted.

Union Average Rate Identifiers

Classification(s) listed under the UAVG identifier indicate that no single majority rate prevailed for those classifications; however, 100% of the data reported for the classifications was union data. EXAMPLE: UAVG-OH-0010 08/29/2014. UAVG indicates that the rate is a weighted union average rate. OH indicates the state. The next number, 0010 in the example, is an internal number used in producing the wage determination. 08/29/2014 indicates the survey completion date for the classifications and rates under that identifier.

A UAVG rate will be updated once a year, usually in January of each year, to reflect a weighted average of the current negotiated/CBA rate of the union locals from which the rate is based.

WAGE DETERMINATION APPEALS PROCESS

1.) Has there been an initial decision in the matter? This can be:

- * an existing published wage determination
- * a survey underlying a wage determination
- * a Wage and Hour Division letter setting forth a position on a wage determination matter
- * a conformance (additional classification and rate) ruling

On survey related matters, initial contact, including requests for summaries of surveys, should be with the Wage and Hour National Office because National Office has responsibility for the Davis-Bacon survey program. If the response from this initial contact is not satisfactory, then the process described in 2.) and 3.) should be followed.

With regard to any other matter not yet ripe for the formal process described here, initial contact should be with the Branch of Construction Wage Determinations. Write to:

Branch of Construction Wage Determinations
Wage and Hour Division
U.S. Department of Labor
200 Constitution Avenue, N.W.
Washington, DC 20210

2.) If the answer to the question in 1.) is yes, then an interested party (those affected by the action) can request review and reconsideration from the Wage and Hour Administrator (See 29 CFR Part 1.8 and 29 CFR Part 7). Write to:

Wage and Hour Administrator
U.S. Department of Labor
200 Constitution Avenue, N.W.

Washington, DC 20210

The request should be accompanied by a full statement of the interested party's position and by any information (wage payment data, project description, area practice material, etc.) that the requestor considers relevant to the issue.

3.) If the decision of the Administrator is not favorable, an interested party may appeal directly to the Administrative Review Board (formerly the Wage Appeals Board). Write to:

Administrative Review Board
U.S. Department of Labor
200 Constitution Avenue, N.W.
Washington, DC 20210

4.) All decisions by the Administrative Review Board are final.

=====

END OF GENERAL DECISIO"

"General Decision Number: WI20220001 10/14/2022

Superseded General Decision Number: WI20210001

State: Wisconsin

Construction Type: Building

Counties: Milwaukee, Ozaukee, Washington and Waukesha Counties in Wisconsin.

BUILDING CONSTRUCTION PROJECTS (Does not include residential construction consisting of single family homes and apartments up to and including 4 stories)

Note: Contracts subject to the Davis-Bacon Act are generally required to pay at least the applicable minimum wage rate required under Executive Order 14026 or Executive Order 13658. Please note that these Executive Orders apply to covered contracts entered into by the federal government that are subject to the Davis-Bacon Act itself, but do not apply to contracts subject only to the Davis-Bacon Related Acts, including those set forth at 29 CFR 5.1(a)(2)-(60).

If the contract is entered into on or after January 30, 2022, or the contract is renewed or extended (e.g., an option is exercised) on or after January 30, 2022:	. Executive Order 14026 generally applies to the contract. . The contractor must pay all covered workers at least \$15.00 per hour (or the applicable wage rate listed on this wage determination, if it is higher) for all hours spent performing on the contract in 2022.
If the contract was awarded on or between January 1, 2015 and January 29, 2022, and the contract is not renewed or extended on or after January 30, 2022:	. Executive Order 13658 generally applies to the contract. . The contractor must pay all covered workers at least \$11.25 per hour (or the applicable wage rate listed on this wage determination, if it is higher) for all hours spent performing on that contract in 2022.

The applicable Executive Order minimum wage rate will be adjusted annually. If this contract is covered by one of the Executive Orders and a classification considered necessary for performance of work on the contract does not appear on this wage determination, the contractor must still submit a conformance request.

Additional information on contractor requirements and worker protections under the Executive Orders is available at <https://www.dol.gov/agencies/whd/government-contracts>.

Modification Number	Publication Date
0	01/07/2022
1	02/04/2022
2	02/18/2022
3	02/25/2022
4	03/18/2022
5	04/29/2022
6	06/17/2022
7	07/08/2022
8	07/15/2022
9	08/05/2022
10	10/14/2022

ASBE0205-001 06/01/2001

	Rates	Fringes
Asbestos Removal worker/hazardous material handler		
Includes preparation, wetting, stripping, removal, scrapping, vacuuming, bagging and disposing of all insulation materials from mechanical systems, whether they contain asbestos or not.....	\$ 17.90	4.45

BOIL0107-001 01/01/2021

	Rates	Fringes
BOILERMAKER		
Boilermaker.....	\$ 39.52	31.50
Small Boiler Repair (under 25,000 lbs/hr).....	\$ 26.91	16.00

BRWI0005-001 06/01/2021

	Rates	Fringes
TERRAZZO WORKER.....	\$ 38.35	23.59
TILE LAYER.....	\$ 37.35	23.59

BRWI0008-001 06/01/2021

	Rates	Fringes
BRICKLAYER.....	\$ 42.38	24.64

BRWI0008-003 06/01/2019

	Rates	Fringes
Marble Mason.....	\$ 38.93	24.22

CARP0264-001 06/01/2016

	Rates	Fringes
Carpenter & Soft Floor Layer (Including Acoustical work and Drywall hanging;		

Excluding Batt Insulation).....\$ 35.78 22.11

CARP2337-002 06/01/2019

Rates Fringes

MILLWRIGHT.....\$ 33.58 21.53

CARP2337-008 06/01/2019

Rates Fringes

PILEDRIVERMAN.....\$ 33.77 23.69

ELEC0494-001 06/01/2021

Rates Fringes

ELECTRICIAN.....\$ 44.39 25.67

ELEC0494-003 06/01/2021

Rates Fringes

Sound & Communications

Installer.....\$ 22.39 18.80

Technician.....\$ 32.49 20.26

Installation, testing, maintenance, operation and servicing of all sound, intercom, telephone interconnect, closed circuit TV systems, radio systems, background music systems, language laboratories, electronic carillon, antenna distribution systems, clock and program systems and low-voltage systems such as visual nurse call, audio/visual nurse call systems, doctors entrance register systems. Includes all wire and cable carrying audio, visual, data, light and radio frequency signals. Includes the installation of conduit, wiremold, or raceways in existing structures that have been occupied for six months or more where required for the protection of the wire or cable, but does not mean a complete conduit or raceway system. work covered does not include the installation of conduit, wiremold or any raceways in any new construction, or the installation of power supply outlets by means of which external electric power is supplied to any of the foregoing equipment or products

ELEV0015-001 01/01/2022

Rates Fringes

ELEVATOR MECHANIC.....\$ 54.60 36.885+a+b

FOOTNOTE:

a. PAID VACATION: 8% of regular basic for employees with more than 5 years of service, and 6% for 6 months to 5 years of service.

b. PAID HOLIDAYS: New Years Day, Memorial Day, Independence Day, Labor Day, Veterans Day, Thanksgiving Day, Friday after Thanksgiving, and Christmas Day.

ENGI0139-001 06/01/2022

KENOSHA, MILWAUKEE, OZAUKEE, RACINE, WASHINGTON, AND WAUKESHA
COUNTIES

	Rates	Fringes
Power Equipment Operator		
Group 1.....	\$ 49.01	25.30
Group 2.....	\$ 48.51	25.30
Group 3.....	\$ 48.01	25.30
Group 4.....	\$ 47.17	25.30
Group 5.....	\$ 43.39	25.30
Group 6.....	\$ 38.24	25.30

HAZARDOUS WASTE PREMIUMS:

EPA Level "A" Protection: \$3.00 per hour
 EPA Level "B" Protection: \$2.00 per hour
 EPA Level "C" Protection: \$1.00 per hour

POWER EQUIPMENT OPERATORS CLASSIFICATIONS

GROUP 1: Cranes, Tower Cranes, Pedestal Tower Cranes and Derricks with or w/o attachments with a lifting capacity of over 100 tons; or Cranes, Tower Cranes, Pedestal Tower Cranes and Derricks with boom, leads, and/or jib lengths measuring 176 feet or longer; Self-Erecting Tower Cranes over 4000 lbs lifting capacity; All Cranes with Boom Dollies; Boring Machines (directional); Master Mechanic. \$0.50 additional per hour per 100 tons or 100 ft of boom over 200 ft or lifting capacity of crane over 200 tons to a maximum of 300 tons or 300 ft. Thereafter an increase of \$0.01 per ft or ton, whichever is greater.

GROUP 2: Cranes, Tower Cranes, Pedestal Tower Cranes and Derricks with or without attachments with a lifting capacity of 100 tons or less; or Cranes, Tower Cranes Portable Tower Cranes, Pedestal Tower Cranes and Derricks with boom, leads and/or jib lengths measuring 175 feet or less; Backhoes (excavators) 130,000 lbs and over; Caisson Rigs; Pile Drivers; Boring Machines (vertical or horizontal), Versi-Lift, Tri-Lift, Gantry 20,000 lbs & over.

GROUP 3: Backhoe (excavator) under 130,000 lbs; Self-erecting Tower Crane 4000 lbs & under lifting capacity; Traveling Crane (bridge type); Skid Rigs; Dredge Operator; Mechanic; Concrete Paver (over 27E); Concrete Spreader and Distributor; Forklift/ Telehandler (machinery- moving / steel erection); Hydro Blaster, 10,000 psi and over

GROUP 4: Material Hoists; Stack Hoists; Hydraulic Backhoe (tractor or truck mounted); Hydraulic Crane, 5 tons or under (tractor or truck mounted); Hoist (tuggers 5 tons & over); Hydro-Excavators/Daylighters; Concrete Pumps Rotec type Conveyors; Tractor/Bulldozer/End Loader (over 40 hp); Motor Patrol; Scraper Operator; Sideboom; Straddle Carrier; Welder; Bituminous Plant and Paver Operator; Roller over 5 tons; Rail Leveling Machine (Railroad); Tie Placer; Tie Extractor; Tie Tamper; Stone Leveler; Rotary Drill Operator and Blaster; Percussion Drill Operator; Air Track Drill and/or Hammers; Gantry (under 20,000 lbs); Tencher (wheel type or chain type having 8 inch or larger bucket); Milling Machine; Off-Road Material Haulers.

GROUP 5: Backfiller; Concrete Auto Breaker (large); Concrete Finishing Machines (road type); Rubber Tired Roller;

Concrete Batch Hopper; Concrete Conveyor Systems; Grout Pumps; Concrete Mixers (14S or over); Screw Type Pumps and Gypsum Pumps; Tractor, Bulldozer, End Loader (under 40 hp); Trencher (chain type, bucket under 8 inch); Industrial Locomotives; Rollers under 5 tons; Stump Grinder/Chipper (Large); Timber Equipment; Firemen (pile drivers and derricks); Personnel Hoist, Telehandler over 8000 lbs; Robotic Tool Carrier with or without attachments

GROUP 6: Tampers - Compactors (riding type); Assistant Engineer; A-Frames and Winch Trucks; Concrete Auto Breaker; Hydrohammers (small); Brooms and Sweepers; Hoist (tuggers under 5 tons); Boats (Tug, Safety, Work Barges, Launch); Shouldering Machine Operator; Prestress Machines; Screed Operator; Stone Crushers and Screening Plants; Screed Operators (milling machine), Farm or Industrial Tractor Mounted Equipment; Post Hole Digger; Fireman (asphalt plants); Air Compressors over 400 CFM; Generators, over 150 KW; Augers (vertical and horizontal); Air, Electric, Hydraulic Jacks (slipform); Skid Steer Loaders (with or without attachments); Boiler Operators (temporary heat); Refrigeration Plant/Freeze Machines; Power Pack Vibratory/Ultra Sound Drivers and Extractors; Welding Machines; Heaters (mechanical); Pumps; Winches (small electric); Oiler and Greaser; Rotary Drill Tender; Conveyor; Forklifts/Telehandler 8000 lbs & under; Elevators: Automatic Hoists; Pumps (well points); Combination Small Equipment Operators

 IRON0008-005 06/01/2021

	Rates	Fringes
IRONWORKER.....	\$ 40.57	28.40

Paid Holidays: New Year's Day, Memorial Day, July 4th, Labor Day, Thanksgiving Day & Christmas Day.

 LAB00113-001 06/06/2022

	Rates	Fringes
LABORER		
(1) General Laborer (Including Plaster Tender)..	\$ 36.53	21.48
(2) Air & Electric Equipment, Mortar Mixer, Scaffold Builder, Erector, and Swing Stage.....	\$ 36.66	21.48
(3) Jackhammer Operator, Gunnite Machine Man.....	\$ 36.80	21.48
(4) Caisson Worker - Topman.	\$ 36.89	21.48
(5) Construction Specialist.	\$ 37.10	21.48
(6) Nozzleman.....	\$ 37.14	21.48
(7) Caisson Work.....	\$ 37.29	21.48
(8) Barco Tamper.....	\$ 37.94	21.48

 LAB00113-010 06/07/2021

	Rates	Fringes
Asbestos Laborer Asbestos Abatement		

[Preparation, removal, and encapsulation of hazardous materials from non-mechanical systems].....\$ 35.03 20.98

 * PAIN0781-001 06/01/2022

Rates Fringes

Painters:

(1) Brush, Roller.....\$ 37.40 24.80
 (2) Spray & Sandblast.....\$ 38.15 24.80
 (3) Drywall Taper/Finisher..\$ 37.75 24.80

 * PAIN1204-002 06/01/2022

Rates Fringes

GLAZIER.....\$ 40.00 24.94

 PLAS0599-004 06/01/2021

Rates Fringes

CEMENT MASON/CONCRETE FINISHER...\$ 38.59 22.66

 PLAS0599-005 06/01/2017

Rates Fringes

PLASTERER.....\$ 32.65 22.55

 PLUM0075-001 06/01/2021

Rates Fringes

PLUMBER (Including HVAC work)....\$ 48.50 25.29

 PLUM0601-001 06/01/2022

Rates Fringes

PIPEFITTER (Including HVAC work).....\$ 50.00 28.93

 SFWI0183-001 07/01/2022

Rates Fringes

SPRINKLER FITTER.....\$ 48.50 29.31

 SHEE0018-001 06/01/2021

Rates Fringes

Sheet Metal Worker (Including HVAC duct work and Technicians).....\$ 48.60 26.06

 TEAM0662-003 06/01/2022

Rates Fringes

TRUCK DRIVER
 1 & 2 Axles.....\$ 34.07 24.95

3 or more Axles.....\$ 34.22 24.95

* SUWI2002-002 01/23/2002

	Rates	Fringes
Asbestos Worker/Heat and Frost Insulator.....	\$ 25.36	8.37
Laborers:		
Concrete Worker.....	\$ 16.34	3.59
Landscape.....	\$ 8.73 **	8.40
ROOFER.....	\$ 18.01	3.28
Tile & Marble Finisher.....	\$ 13.89 **	7.43

WELDERS - Receive rate prescribed for craft performing operation to which welding is incidental.

** Workers in this classification may be entitled to a higher minimum wage under Executive Order 14026 (\$15.00) or 13658 (\$11.25). Please see the Note at the top of the wage determination for more information.

Note: Executive Order (EO) 13706, Establishing Paid Sick Leave for Federal Contractors applies to all contracts subject to the Davis-Bacon Act for which the contract is awarded (and any solicitation was issued) on or after January 1, 2017. If this contract is covered by the EO, the contractor must provide employees with 1 hour of paid sick leave for every 30 hours they work, up to 56 hours of paid sick leave each year. Employees must be permitted to use paid sick leave for their own illness, injury or other health-related needs, including preventive care; to assist a family member (or person who is like family to the employee) who is ill, injured, or has other health-related needs, including preventive care; or for reasons resulting from, or to assist a family member (or person who is like family to the employee) who is a victim of, domestic violence, sexual assault, or stalking. Additional information on contractor requirements and worker protections under the EO is available at <https://www.dol.gov/agencies/whd/government-contracts>.

Unlisted classifications needed for work not included within the scope of the classifications listed may be added after award only as provided in the labor standards contract clauses (29CFR 5.5 (a) (1) (ii)).

The body of each wage determination lists the classification and wage rates that have been found to be prevailing for the cited type(s) of construction in the area covered by the wage determination. The classifications are listed in alphabetical order of "identifiers" that indicate whether the particular rate is a union rate (current union negotiated rate for local), a survey rate (weighted average rate) or a union average rate (weighted union average rate).

Union Rate Identifiers

A four letter classification abbreviation identifier enclosed in dotted lines beginning with characters other than ""SU"" or ""UAVG"" denotes that the union classification and rate were prevailing for that classification in the survey. Example: PLUM0198-005 07/01/2014. PLUM is an abbreviation identifier of the union which prevailed in the survey for this classification, which in this example would be Plumbers. 0198 indicates the local union number or district council number where applicable, i.e., Plumbers Local 0198. The next number, 005 in the example, is an internal number used in processing the wage determination. 07/01/2014 is the effective date of the most current negotiated rate, which in this example is July 1, 2014.

Union prevailing wage rates are updated to reflect all rate changes in the collective bargaining agreement (CBA) governing this classification and rate.

Survey Rate Identifiers

Classifications listed under the ""SU"" identifier indicate that no one rate prevailed for this classification in the survey and the published rate is derived by computing a weighted average rate based on all the rates reported in the survey for that classification. As this weighted average rate includes all rates reported in the survey, it may include both union and non-union rates. Example: SULA2012-007 5/13/2014. SU indicates the rates are survey rates based on a weighted average calculation of rates and are not majority rates. LA indicates the State of Louisiana. 2012 is the year of survey on which these classifications and rates are based. The next number, 007 in the example, is an internal number used in producing the wage determination. 5/13/2014 indicates the survey completion date for the classifications and rates under that identifier.

Survey wage rates are not updated and remain in effect until a new survey is conducted.

Union Average Rate Identifiers

Classification(s) listed under the UAVG identifier indicate that no single majority rate prevailed for those classifications; however, 100% of the data reported for the classifications was union data. EXAMPLE: UAVG-OH-0010 08/29/2014. UAVG indicates that the rate is a weighted union average rate. OH indicates the state. The next number, 0010 in the example, is an internal number used in producing the wage determination. 08/29/2014 indicates the survey completion date for the classifications and rates under that identifier.

A UAVG rate will be updated once a year, usually in January of each year, to reflect a weighted average of the current negotiated/CBA rate of the union locals from which the rate is based.

WAGE DETERMINATION APPEALS PROCESS

1.) Has there been an initial decision in the matter? This can be:

- * an existing published wage determination
- * a survey underlying a wage determination
- * a Wage and Hour Division letter setting forth a position on a wage determination matter
- * a conformance (additional classification and rate) ruling

On survey related matters, initial contact, including requests for summaries of surveys, should be with the Wage and Hour National Office because National Office has responsibility for the Davis-Bacon survey program. If the response from this initial contact is not satisfactory, then the process described in 2.) and 3.) should be followed.

With regard to any other matter not yet ripe for the formal process described here, initial contact should be with the Branch of Construction Wage Determinations. Write to:

Branch of Construction Wage Determinations
 Wage and Hour Division
 U.S. Department of Labor
 200 Constitution Avenue, N.W.
 Washington, DC 20210

2.) If the answer to the question in 1.) is yes, then an interested party (those affected by the action) can request review and reconsideration from the Wage and Hour Administrator (See 29 CFR Part 1.8 and 29 CFR Part 7). Write to:

Wage and Hour Administrator
 U.S. Department of Labor
 200 Constitution Avenue, N.W.
 Washington, DC 20210

The request should be accompanied by a full statement of the interested party's position and by any information (wage payment data, project description, area practice material, etc.) that the requestor considers relevant to the issue.

3.) If the decision of the Administrator is not favorable, an interested party may appeal directly to the Administrative Review Board (formerly the Wage Appeals Board). Write to:

Administrative Review Board
 U.S. Department of Labor
 200 Constitution Avenue, N.W.
 Washington, DC 20210

4.) All decisions by the Administrative Review Board are final.

=====

END OF GENERAL DECISIO"

NOTICE TO BIDDERS WAGE RATE DECISION

The wage rate decision of the Department of Labor which has been incorporated in these advertised specifications is incomplete in that the classifications may be omitted from the Department of Labor's decision.

Since the bidder is responsible, independently, for ascertaining area practice with respect to the necessity, or lack of necessity, for the use of these classifications in the prosecution of the work contemplated by this project, no inference may be drawn from the omission of these classifications concerning prevailing area practices relative to their use. Further, this omission will not, per se, be construed as establishing any governmental liability for increased labor cost if it is subsequently determined that such classifications are required.

There may be omissions and/or errors in the federal wage rates. The bidder is responsible for evaluating and determining the correct applicable rate.

If a project includes multiple types of construction (highway, bridge over navigable water, sanitary sewer and water main, building) and there is not a separate wage determination for this type of work included in the proposal, use the wage determination that is in the proposal.

If a project includes multiple types of construction, different wage rate determinations may be inserted into the contract (WI10/Highway = in all WisDOT highway contracts, WI15/Heavy = bridge over navigable water per USDOL and US Coast Guard designation, WI8/Heavy (Sewer & Water Line & Tunnel) = sanitary sewer and water main if the cost is more than 20% of the contract and/or at least \$1,000,000, and Building). If multiple wage rate determinations are inserted into the contract, use the classification in the wage determination for the work being done. Use WI15 wage rates when working on the bridge and/or structure from bank to bank. Use WI8 wage rates when working on any sanitary sewer or water main work. Use Building wage rates for all work done within the footprint of the building. Use WI10 wage rates for all other highway work in the contract and approaches to structures. For example, if a laborer is working within the footprint of a building, use the Laborer rate in the Building wage determination inserted in the contract. If a laborer is working on a bridge/structure within the banks, use the Laborer rate in the WI15/Heavy wage determination if inserted in the contract. If the laborer is working on the highway, use the Laborer rate in the WI10/Highway wage determination.



Proposal Schedule of Items

Proposal ID: 20221213016 Project(s): 1000-57-70

Federal ID(s): FR-CRS-0068-2

SECTION: 0001

Contract Items

Alt Set ID:

Alt Mbr ID:

Proposal Line Number	Item ID Description	Approximate Quantity and Units	Unit Price	Bid Amount
0002	108.4400 CPM Progress Schedule	1.000 EACH	_____.	_____.
0004	201.0105 Clearing	14.000 STA	_____.	_____.
0006	201.0120 Clearing	28.000 ID	_____.	_____.
0008	201.0205 Grubbing	14.000 STA	_____.	_____.
0010	201.0220 Grubbing	28.000 ID	_____.	_____.
0012	203.0100 Removing Small Pipe Culverts	3.000 EACH	_____.	_____.
0014	204.0150 Removing Curb & Gutter	86.000 LF	_____.	_____.
0016	204.0155 Removing Concrete Sidewalk	93.000 SY	_____.	_____.
0018	204.0170 Removing Fence	610.000 LF	_____.	_____.
0020	204.0195 Removing Concrete Bases	2.000 EACH	_____.	_____.
0022	204.9060.S Removing (item description) 01. Landscaping Boulders	6.000 EACH	_____.	_____.
0024	204.9060.S Removing (item description) 02. Removing Bollards	4.000 EACH	_____.	_____.
0026	205.0100 Excavation Common	7,620.000 CY	_____.	_____.
0028	205.0400 Excavation Marsh	26.000 CY	_____.	_____.
0030	206.1001 Excavation for Structures Bridges (structure) 01. Pedestrian Bridge & Towers	1.000 EACH	_____.	_____.



Proposal Schedule of Items

Proposal ID: 20221213016 Project(s): 1000-57-70

Federal ID(s): FR-CRS-0068-2

SECTION: 0001

Contract Items

Alt Set ID:

Alt Mbr ID:

Proposal Line Number	Item ID Description	Approximate Quantity and Units	Unit Price	Bid Amount
0032	208.0100 Borrow	158.000 CY	_____.	_____.
0034	208.1100 Select Borrow	163.000 CY	_____.	_____.
0036	209.1100 Backfill Granular Grade 1	303.000 CY	_____.	_____.
0038	210.1100 Backfill Structure Type A	1,082.000 CY	_____.	_____.
0040	213.0100 Finishing Roadway (project) 01. 1000-57-70	1.000 EACH	_____.	_____.
0042	305.0120 Base Aggregate Dense 1 1/4-Inch	1,350.000 TON	_____.	_____.
0044	311.0115 Breaker Run	1,090.000 CY	_____.	_____.
0046	416.0610 Drilled Tie Bars	16.000 EACH	_____.	_____.
0048	450.4000 HMA Cold Weather Paving	30.000 TON	_____.	_____.
0050	455.0605 Tack Coat	72.000 GAL	_____.	_____.
0052	465.0105 Asphaltic Surface	118.000 TON	_____.	_____.
0054	465.0125 Asphaltic Surface Temporary	25.000 TON	_____.	_____.
0056	502.0100 Concrete Masonry Bridges	718.000 CY	_____.	_____.
0058	502.4104 Adhesive Anchors 1/2-inch	136.000 EACH	_____.	_____.
0060	505.0400 Bar Steel Reinforcement HS Structures	71,100.000 LB	_____.	_____.
0062	505.0600 Bar Steel Reinforcement HS Coated Structures	56,120.000 LB	_____.	_____.



Proposal Schedule of Items

Proposal ID: 20221213016 Project(s): 1000-57-70

Federal ID(s): FR-CRS-0068-2

SECTION: 0001

Contract Items

Alt Set ID:

Alt Mbr ID:

Proposal Line Number	Item ID Description	Approximate Quantity and Units	Unit Price	Bid Amount
0064	506.3009 Welded Stud Shear Connectors 3/4x5-Inch	679.000 EACH	_____.	_____.
0066	516.0500 Rubberized Membrane Waterproofing	292.000 SY	_____.	_____.
0068	517.0601 Painting Epoxy System (structure) 01. Pedestrian Bridge & Towers	1.000 EACH	_____.	_____.
0070	522.1024 Apron Endwalls for Culvert Pipe Reinforced Concrete 24-Inch	4.000 EACH	_____.	_____.
0072	550.2128 Piling CIP Concrete 12 3/4 X 0.50-Inch	4,600.000 LF	_____.	_____.
0074	601.0331 Concrete Curb & Gutter 31-Inch	40.000 LF	_____.	_____.
0076	601.0407 Concrete Curb & Gutter 18-Inch Type D	46.000 LF	_____.	_____.
0078	602.0410 Concrete Sidewalk 5-Inch	5,710.000 SF	_____.	_____.
0080	602.0505 Curb Ramp Detectable Warning Field Yellow	1,680.000 SF	_____.	_____.
0082	608.0318 Storm Sewer Pipe Reinforced Concrete Class III 18-Inch	70.000 LF	_____.	_____.
0084	608.0324 Storm Sewer Pipe Reinforced Concrete Class III 24-Inch	1,104.000 LF	_____.	_____.
0086	611.0530 Manhole Covers Type J	3.000 EACH	_____.	_____.
0088	611.0535 Manhole Covers Type J-Special	3.000 EACH	_____.	_____.
0090	611.0606 Inlet Covers Type B	11.000 EACH	_____.	_____.
0092	611.0610 Inlet Covers Type BW	1.000 EACH	_____.	_____.



Proposal Schedule of Items

Proposal ID: 20221213016 Project(s): 1000-57-70

Federal ID(s): FR-CRS-0068-2

SECTION: 0001

Contract Items

Alt Set ID:

Alt Mbr ID:

Proposal Line Number	Item ID Description	Approximate Quantity and Units	Unit Price	Bid Amount
0094	611.2003 Manholes 3-FT Diameter	3.000 EACH	_____.	_____.
0096	611.2004 Manholes 4-FT Diameter	3.000 EACH	_____.	_____.
0098	611.3004 Inlets 4-FT Diameter	12.000 EACH	_____.	_____.
0100	611.8120.S Cover Plates Temporary	1.000 EACH	_____.	_____.
0102	611.9710 Salvaged Inlet Covers	1.000 EACH	_____.	_____.
0104	612.0108 Pipe Underdrain 8-Inch	870.000 LF	_____.	_____.
0106	612.0208 Pipe Underdrain Unperforated 8-Inch	113.000 LF	_____.	_____.
0108	616.0204 Fence Chain Link 4-FT	14.000 LF	_____.	_____.
0110	616.0206 Fence Chain Link 6-FT	637.000 LF	_____.	_____.
0112	616.0329 Gates Chain Link (width) 01. 5-FT	2.000 EACH	_____.	_____.
0114	616.0329 Gates Chain Link (width) 02. 22-FT	1.000 EACH	_____.	_____.
0116	616.0700.S Fence Safety	1,000.000 LF	_____.	_____.
0118	618.0100 Maintenance And Repair of Haul Roads (project) 01. 1000-57-70	1.000 EACH	_____.	_____.
0120	619.1000 Mobilization	1.000 EACH	_____.	_____.
0122	624.0100 Water	26.000 MGAL	_____.	_____.
0124	625.0100 Topsoil	5,680.000 SY	_____.	_____.



Proposal Schedule of Items

Proposal ID: 20221213016 Project(s): 1000-57-70

Federal ID(s): FR-CRS-0068-2

SECTION: 0001

Contract Items

Alt Set ID:

Alt Mbr ID:

Proposal Line Number	Item ID Description	Approximate Quantity and Units	Unit Price	Bid Amount
0126	628.1504 Silt Fence	820.000 LF	_____.	_____.
0128	628.1520 Silt Fence Maintenance	820.000 LF	_____.	_____.
0130	628.1905 Mobilizations Erosion Control	20.000 EACH	_____.	_____.
0132	628.1910 Mobilizations Emergency Erosion Control	13.000 EACH	_____.	_____.
0134	628.2006 Erosion Mat Urban Class I Type A	5,680.000 SY	_____.	_____.
0136	628.2021 Erosion Mat Class II Type A	2,530.000 SY	_____.	_____.
0138	628.7010 Inlet Protection Type B	2.000 EACH	_____.	_____.
0140	628.7504 Temporary Ditch Checks	60.000 LF	_____.	_____.
0142	628.7555 Culvert Pipe Checks	3.000 EACH	_____.	_____.
0144	629.0210 Fertilizer Type B	4.200 CWT	_____.	_____.
0146	630.0120 Seeding Mixture No. 20	110.000 LB	_____.	_____.
0148	630.0200 Seeding Temporary	110.000 LB	_____.	_____.
0150	630.0500 Seed Water	2,076.000 MGAL	_____.	_____.
0152	631.0300 Sod Water	58.000 MGAL	_____.	_____.
0154	631.1000 Sod Lawn	2,515.000 SY	_____.	_____.
0156	632.0101 Trees (species) (size) (root) 01. Juniperus Chinensis 'Ketelleri', B&B, 6' HT	15.000 EACH	_____.	_____.



Proposal Schedule of Items

Proposal ID: 20221213016 Project(s): 1000-57-70

Federal ID(s): FR-CRS-0068-2

SECTION: 0001

Contract Items

Alt Set ID:

Alt Mbr ID:

Proposal Line Number	Item ID Description	Approximate Quantity and Units	Unit Price	Bid Amount
0158	632.0101 Trees (species) (size) (root) 02. Juniperus Scopoulorum 'Moonglow', B&B, 6' HT	15.000 EACH	_____.	_____.
0160	632.9101 Landscape Planting Surveillance and Care Cycles	13.000 EACH	_____.	_____.
0162	638.2102 Moving Signs Type II	1.000 EACH	_____.	_____.
0164	642.5201 Field Office Type C	1.000 EACH	_____.	_____.
0166	643.0300 Traffic Control Drums	9,519.000 DAY	_____.	_____.
0168	643.0420 Traffic Control Barricades Type III	3,718.000 DAY	_____.	_____.
0170	643.0715 Traffic Control Warning Lights Type C	2,782.000 DAY	_____.	_____.
0172	643.0800 Traffic Control Arrow Boards	284.000 DAY	_____.	_____.
0174	643.0900 Traffic Control Signs	4,681.000 DAY	_____.	_____.
0176	643.5000 Traffic Control	1.000 EACH	_____.	_____.
0178	646.1005 Marking Line Paint 4-Inch	100.000 LF	_____.	_____.
0180	646.8305 Marking Parking Stall Paint	80.000 LF	_____.	_____.
0182	650.4000 Construction Staking Storm Sewer	35.000 EACH	_____.	_____.
0184	650.5000 Construction Staking Base	706.000 LF	_____.	_____.
0186	650.5500 Construction Staking Curb Gutter and Curb & Gutter	86.000 LF	_____.	_____.



Proposal Schedule of Items

Proposal ID: 20221213016 Project(s): 1000-57-70

Federal ID(s): FR-CRS-0068-2

SECTION: 0001

Contract Items

Alt Set ID:

Alt Mbr ID:

Proposal Line Number	Item ID Description	Approximate Quantity and Units	Unit Price	Bid Amount
0188	650.6501 Construction Staking Structure Layout (structure) 01. Pedestrian Bridge & Towers	1.000 EACH	_____.	_____.
0190	650.8501 Construction Staking Electrical Installations (project) 01. 1000-57-70	1.000 EACH	_____.	_____.
0192	650.9500 Construction Staking Sidewalk (project) 01. 1000-57-70	1.000 EACH	_____.	_____.
0194	650.9911 Construction Staking Supplemental Control (project) 01. 1000-57-70	1.000 EACH	_____.	_____.
0196	650.9920 Construction Staking Slope Stakes	1,676.000 LF	_____.	_____.
0198	659.5000.S Lamp, Ballast, LED, Switch Disposal by Contractor	2.000 EACH	_____.	_____.
0200	690.0150 Sawing Asphalt	96.000 LF	_____.	_____.
0202	690.0250 Sawing Concrete	66.000 LF	_____.	_____.
0204	715.0502 Incentive Strength Concrete Structures	4,494.000 DOL	1.00000	4,494.00
0206	801.0117 Railroad Flagging Reimbursement	285,660.000 DOL	1.00000	285,660.00
0208	ASP.1T0A On-the-Job Training Apprentice at \$5.00/HR	4,000.000 HRS	5.00000	20,000.00
0210	ASP.1T0G On-the-Job Training Graduate at \$5.00/HR	13,500.000 HRS	5.00000	67,500.00
0212	SPV.0060 Special 01. Diesel-Engine-Driven Generator Sets	1.000 EACH	_____.	_____.
0214	SPV.0060 Special 02. Canopy Column Anchor Rod Assemblies	26.000 EACH	_____.	_____.



Proposal Schedule of Items

Proposal ID: 20221213016 Project(s): 1000-57-70

Federal ID(s): FR-CRS-0068-2

SECTION: 0001

Contract Items

Alt Set ID:

Alt Mbr ID:

Proposal Line Number	Item ID Description	Approximate Quantity and Units	Unit Price	Bid Amount
0216	SPV.0060 Special 03. Tower Column Anchor Rod Assemblies	46.000 EACH	_____.	_____.
0218	SPV.0060 Special 04. Switchboards	1.000 EACH	_____.	_____.
0220	SPV.0060 Special 05. Transfer Switches	1.000 EACH	_____.	_____.
0222	SPV.0060 Special 06. Traction Elevators	4.000 EACH	_____.	_____.
0224	SPV.0060 Special 07. Doors And Door Hardware	22.000 EACH	_____.	_____.
0226	SPV.0060 Special 08. Utility Line Opening (ULO)	20.000 EACH	_____.	_____.
0228	SPV.0060 Special 09. Marking Line Paint Text 4-Inch Black	32.000 EACH	_____.	_____.
0230	SPV.0060 Special 10. Pipe Bollard	4.000 EACH	_____.	_____.
0232	SPV.0060 Special 11. Sanitary Manhole 4-Foot Diameter	1.000 EACH	_____.	_____.
0234	SPV.0060 Special 12. Grass, Blue Oat	17.000 EACH	_____.	_____.
0236	SPV.0060 Special 13. Grass, Hameln Dwarf Foundation	21.000 EACH	_____.	_____.
0238	SPV.0060 Special 14. Grass, Karl Foerster Reed	36.000 EACH	_____.	_____.
0240	SPV.0060 Special 15. Remove and Salvage Lighting Equipment	2.000 EACH	_____.	_____.
0242	SPV.0060 Special 16. Fall Restraint System	1.000 EACH	_____.	_____.
0244	SPV.0060 Special 17. HVAC Work	1.000 EACH	_____.	_____.



Proposal Schedule of Items

Proposal ID: 20221213016 Project(s): 1000-57-70

Federal ID(s): FR-CRS-0068-2

SECTION: 0001

Contract Items

Alt Set ID:

Alt Mbr ID:

Proposal Line Number	Item ID Description	Approximate Quantity and Units	Unit Price	Bid Amount
0246	SPV.0060 Special 18. Lighting	1.000 EACH	_____.	_____.
0248	SPV.0060 Special 19. General Electrical Work	1.000 EACH	_____.	_____.
0250	SPV.0060 Special 20. Fire Alarm System	1.000 EACH	_____.	_____.
0252	SPV.0060 Special 21. Lightning Protection For Structures	1.000 EACH	_____.	_____.
0254	SPV.0060 Special 22. Plumbing Work	1.000 EACH	_____.	_____.
0256	SPV.0060 Special 23. Stairs	1.000 EACH	_____.	_____.
0258	SPV.0060 Special 24. Rough Carpentry	1.000 EACH	_____.	_____.
0260	SPV.0060 Special 25. Metal Fabrications	1.000 EACH	_____.	_____.
0262	SPV.0060 Special 26. Gypsum Board Partitions And Assemblies	1.000 EACH	_____.	_____.
0264	SPV.0060 Special 27. Ceilings	1.000 EACH	_____.	_____.
0266	SPV.0060 Special 28. Interior And Exterior Signage	1.000 EACH	_____.	_____.
0268	SPV.0060 Special 29. Other Architectural Work	1.000 EACH	_____.	_____.
0270	SPV.0060 Special 30. Fire Suppression	1.000 EACH	_____.	_____.
0272	SPV.0060 Special 31. Pids, Communications, And Security Work	1.000 EACH	_____.	_____.
0274	SPV.0060 Special 32. Wheelchair Lift Enclosure, New and Relocations	1.000 EACH	_____.	_____.
0276	SPV.0085 Special 01. Structural Steel	371,847.000 LB	_____.	_____.



Proposal Schedule of Items

Proposal ID: 20221213016 Project(s): 1000-57-70

Federal ID(s): FR-CRS-0068-2

SECTION: 0001

Contract Items

Alt Set ID:

Alt Mbr ID:

Proposal Line Number	Item ID Description	Approximate Quantity and Units	Unit Price	Bid Amount
0278	SPV.0090 Special 01. Railing Pipe	180.000 LF	_____.	_____.
0280	SPV.0090 Special 02. Drilled Shaft Foundations 24-Inch	555.000 LF	_____.	_____.
0282	SPV.0090 Special 03. Helical Pile	2,190.000 LF	_____.	_____.
0284	SPV.0090 Special 04. Marking Line Paint 4.5-Inch Yellow	800.000 LF	_____.	_____.
0286	SPV.0090 Special 05. Marking Line Contrast Paint 2-Inch Black	800.000 LF	_____.	_____.
0288	SPV.0090 Special 06. Removable Intertrack Fence	825.000 LF	_____.	_____.
0290	SPV.0090 Special 07. Sanitary Sewer PVC 6-Inch	110.000 LF	_____.	_____.
0292	SPV.0090 Special 08. Sanitary Sewer PVC 8-Inch	60.000 LF	_____.	_____.
0294	SPV.0090 Special 09. Concrete Barrier Temporary Precast Left In Place	300.000 LF	_____.	_____.
0296	SPV.0090 Special 10. Construction Staking Fence	651.000 LF	_____.	_____.
0298	SPV.0165 Special 01. Masonry And Cast Stone Work	9,916.000 SF	_____.	_____.
0300	SPV.0165 Special 02. Steel Decking	8,115.000 SF	_____.	_____.
0302	SPV.0165 Special 03. Aluminum And Glass Curtainwalls	7,278.000 SF	_____.	_____.
0304	SPV.0165 Special 04. Roofing And Accessories	11,995.000 SF	_____.	_____.
0306	SPV.0165 Special 05. Exterior Metal Panels	1,274.000 SF	_____.	_____.



Proposal Schedule of Items

Proposal ID: 20221213016 Project(s): 1000-57-70

Federal ID(s): FR-CRS-0068-2

SECTION: 0001

Contract Items

Alt Set ID:

Alt Mbr ID:

Proposal Line Number	Item ID Description	Approximate Quantity and Units	Unit Price	Bid Amount
0308	SPV.0165 Special 06. Louvers	1,278.000 SF	_____.	_____.
0310	SPV.0165 Special 07. Finishes	20,373.000 SF	_____.	_____.
0312	SPV.0165 Special 08. Temporary Shoring Railroad	2,400.000 SF	_____.	_____.
Section: 0001			Total:	_____.
			Total Bid:	_____.

PLEASE ATTACH ADDENDA HERE



Wisconsin Department of Transportation

November 10, 2022

**Division of Transportation Systems
Development**

Bureau of Project Development
4822 Madison Yards Way, 4th Floor South
Madison, WI 53705

Telephone: (608) 266-1631
Facsimile (FAX): (608) 266-8459

NOTICE TO ALL CONTRACTORS:

**Proposal #16: 1000-57-70, FR-CRS-0068-2
Milwaukee Airport 2nd Platform
RR Crossing 393023R to 1200ft South
STH 119
Milwaukee County**

Letting of December 13, 2022

This is Addendum No. 01, which provides for the following:

Special Provisions:

Revised Special Provisions	
Article No.	Description
3	Mandatory Pre-Bid Meeting

The responsibility for notifying potential subcontractors and suppliers of these changes remains with the prime contractor.

Sincerely,

Mike Coleman

Proposal Development Specialist
Proposal Management Section

ADDENDUM NO. 01

1000-57-70

November 10, 2022

Special Provisions

3. Mandatory Pre-Bid Meeting.

Replace entire article language with the following:

Add the following to standard spec 102.3.1:

Prospective bidders are required to attend a mandatory pre-bid meeting Tuesday, November 15, 2022, at 9:00 AM virtually via the meeting link published on the HCCI website, and as provided below:

Microsoft Teams meeting

Join on your computer, mobile app or room device

[Click here to join the meeting](#)

Meeting ID: 253 482 035 679

Passcode: ozZbv5

[Download Teams](#) | [Join on the web](#)

Or call in (audio only)

[+1 608-571-2209,,91807317#](#) United States, Madison

Phone Conference ID: 918 073 17#

[Find a local number](#) | [Reset PIN](#)

[Learn More](#) | [Meeting options](#)

Contractors will be able to obtain a bidding proposal form and submit a bid on this proposal only if they have been documented as attending the mandatory pre-bid meeting.

The meeting agenda will include the following:

- Project Overview
- Railroad Coordination
- Airport Coordination
- Safety
- Contractor Compliance
- DBE Business Outreach Provision

No meeting minutes will be prepared, but a published response will be sent out addressing all questions raised at the meeting.

stp-102-010

END OF ADDENDUM



Wisconsin Department of Transportation

December 5, 2022

**Division of Transportation Systems
Development**

Bureau of Project Development
4822 Madison Yards Way, 4th Floor South
Madison, WI 53705

Telephone: (608) 266-1631
Facsimile (FAX): (608) 266-8459

NOTICE TO ALL CONTRACTORS:

**Proposal #16: 1000-57-70, FR-CRS-0068-2
Milwaukee Airport 2nd Platform
RR Crossing 393023R to 1200ft South
STH 119
Milwaukee County**

Letting of December 13, 2022

This is Addendum No. 02, which provides for the following:

Attached is a copy of the revised WI 01 Buildings Davis Bacon Prevailing Wage Rates that are included in this proposal. The updated wage rates are dated November 11, 2022 and are effective on or after November 21, 2022.

The responsibility for notifying potential subcontractors and suppliers of these changes remains with the prime contractor.

Sincerely,

Mike Coleman

Proposal Development Specialist
Proposal Management Section

END OF ADDENDUM

"General Decision Number: WI20220001 11/11/2022

Superseded General Decision Number: WI20210001

State: Wisconsin

Construction Type: Building

Counties: Milwaukee, Ozaukee, Washington and Waukesha Counties in Wisconsin.

BUILDING CONSTRUCTION PROJECTS (Does not include residential construction consisting of single family homes and apartments up to and including 4 stories)

Note: Contracts subject to the Davis-Bacon Act are generally required to pay at least the applicable minimum wage rate required under Executive Order 14026 or Executive Order 13658. Please note that these Executive Orders apply to covered contracts entered into by the federal government that are subject to the Davis-Bacon Act itself, but do not apply to contracts subject only to the Davis-Bacon Related Acts, including those set forth at 29 CFR 5.1(a)(2)-(60).

If the contract is entered into on or after January 30, 2022, or the contract is renewed or extended (e.g., an option is exercised) on or after January 30, 2022:	. Executive Order 14026 generally applies to the contract. . The contractor must pay all covered workers at least \$15.00 per hour (or the applicable wage rate listed on this wage determination, if it is higher) for all hours spent performing on the contract in 2022.
If the contract was awarded on or between January 1, 2015 and January 29, 2022, and the contract is not renewed or extended on or after January 30, 2022:	. Executive Order 13658 generally applies to the contract. . The contractor must pay all covered workers at least \$11.25 per hour (or the applicable wage rate listed on this wage determination, if it is higher) for all hours spent performing on that contract in 2022.

The applicable Executive Order minimum wage rate will be adjusted annually. If this contract is covered by one of the Executive Orders and a classification considered necessary for performance of work on the contract does not appear on this wage determination, the contractor must still submit a conformance request.

Additional information on contractor requirements and worker protections under the Executive Orders is available at <https://www.dol.gov/agencies/whd/government-contracts>.

Modification Number	Publication Date
0	01/07/2022
1	02/04/2022
2	02/18/2022
3	02/25/2022
4	03/18/2022
5	04/29/2022
6	06/17/2022
7	07/08/2022
8	07/15/2022
9	08/05/2022
10	10/14/2022
11	11/11/2022

* ASBE0019-001 06/01/2022

	Rates	Fringes
Asbestos Removal worker/hazardous material handler Includes preparation, wetting, stripping, removal, scrapping, vacuuming, bagging and disposing of all insulation materials from mechanical systems, whether they contain asbestos or not.....	\$ 40.68	35.60

BOIL0107-001 01/01/2021

	Rates	Fringes
BOILERMAKER Boilermaker.....	\$ 39.52	31.50
Small Boiler Repair (under 25,000 lbs/hr).....	\$ 26.91	16.00

BRWI0005-001 06/01/2021

	Rates	Fringes
TERRAZZO WORKER.....	\$ 38.35	23.59
TILE LAYER.....	\$ 37.35	23.59

BRWI0008-001 06/01/2021

	Rates	Fringes
BRICKLAYER.....	\$ 42.38	24.64

BRWI0008-003 06/01/2019

	Rates	Fringes
Marble Mason.....	\$ 38.93	24.22

CARP0264-001 06/01/2016

	Rates	Fringes
Carpenter & Soft Floor Layer (Including Acoustical work		

and Drywall hanging;
Excluding Batt Insulation).....\$ 35.78 22.11

CARP2337-002 06/01/2019

	Rates	Fringes
MILLWRIGHT.....	\$ 33.58	21.53

CARP2337-008 06/01/2019

	Rates	Fringes
PILEDRIVERMAN.....	\$ 33.77	23.69

ELEC0494-001 06/01/2021

	Rates	Fringes
ELECTRICIAN.....	\$ 44.39	25.67

ELEC0494-003 06/01/2021

	Rates	Fringes
Sound & Communications		
Installer.....	\$ 22.39	18.80
Technician.....	\$ 32.49	20.26

Installation, testing, maintenance, operation and servicing of all sound, intercom, telephone interconnect, closed circuit TV systems, radio systems, background music systems, language laboratories, electronic carillon, antenna distribution systems, clock and program systems and low-voltage systems such as visual nurse call, audio/visual nurse call systems, doctors entrance register systems. Includes all wire and cable carrying audio, visual, data, light and radio frequency signals. Includes the installation of conduit, wiremold, or raceways in existing structures that have been occupied for six months or more where required for the protection of the wire or cable, but does not mean a complete conduit or raceway system. work covered does not include the installation of conduit, wiremold or any raceways in any new construction, or the installation of power supply outlets by means of which external electric power is supplied to any of the foregoing equipment or products

ELEV0015-001 01/01/2022

	Rates	Fringes
ELEVATOR MECHANIC.....	\$ 54.60	36.885+a+b

FOOTNOTE:

- a. PAID VACATION: 8% of regular basic for employees with more than 5 years of service, and 6% for 6 months to 5 years of service.
- b. PAID HOLIDAYS: New Years Day, Memorial Day, Independence Day, Labor Day, Veterans Day, Thanksgiving Day, Friday after Thanksgiving, and Christmas Day.

ENGI0139-001 06/01/2022

KENOSHA, MILWAUKEE, OZAUKEE, RACINE, WASHINGTON, AND WAUKESHA
COUNTIES

	Rates	Fringes
Power Equipment Operator		
Group 1.....	\$ 49.01	25.30
Group 2.....	\$ 48.51	25.30
Group 3.....	\$ 48.01	25.30
Group 4.....	\$ 47.17	25.30
Group 5.....	\$ 43.39	25.30
Group 6.....	\$ 38.24	25.30

HAZARDOUS WASTE PREMIUMS:

EPA Level "A" Protection: \$3.00 per hour
 EPA Level "B" Protection: \$2.00 per hour
 EPA Level "C" Protection: \$1.00 per hour

POWER EQUIPMENT OPERATORS CLASSIFICATIONS

GROUP 1: Cranes, Tower Cranes, Pedestal Tower Cranes and Derricks with or w/o attachments with a lifting capacity of over 100 tons; or Cranes, Tower Cranes, Pedestal Tower Cranes and Derricks with boom, leads, and/or jib lengths measuring 176 feet or longer; Self-Erecting Tower Cranes over 4000 lbs lifting capacity; All Cranes with Boom Dollies; Boring Machines (directional); Master Mechanic. \$0.50 additional per hour per 100 tons or 100 ft of boom over 200 ft or lifting capacity of crane over 200 tons to a maximum of 300 tons or 300 ft. Thereafter an increase of \$0.01 per ft or ton, whichever is greater.

GROUP 2: Cranes, Tower Cranes, Pedestal Tower Cranes and Derricks with or without attachments with a lifting capacity of 100 tons or less; or Cranes, Tower Cranes Portable Tower Cranes, Pedestal Tower Cranes and Derricks with boom, leads and/or jib lengths measuring 175 feet or less; Backhoes (excavators) 130,000 lbs and over; Caisson Rigs; Pile Drivers; Boring Machines (vertical or horizontal), Versi-Lift, Tri-Lift, Gantry 20,000 lbs & over.

GROUP 3: Backhoe (excavator) under 130,000 lbs; Self-erecting Tower Crane 4000 lbs & under lifting capacity; Traveling Crane (bridge type); Skid Rigs; Dredge Operator; Mechanic; Concrete Paver (over 27E); Concrete Spreader and Distributor; Forklift/ Telehandler (machinery- moving / steel erection); Hydro Blaster, 10,000 psi and over

GROUP 4: Material Hoists; Stack Hoists; Hydraulic Backhoe (tractor or truck mounted); Hydraulic Crane, 5 tons or under (tractor or truck mounted); Hoist (tuggers 5 tons & over); Hydro-Excavators/Daylighters; Concrete Pumps Rotec type Conveyors; Tractor/Bulldozer/End Loader (over 40 hp); Motor Patrol; Scraper Operator; Sideboom; Straddle Carrier; Welder; Bituminous Plant and Paver Operator; Roller over 5 tons; Rail Leveling Machine (Railroad); Tie Placer; Tie Extractor; Tie Tamper; Stone Leveler; Rotary Drill Operator and Blaster; Percussion Drill Operator; Air Track Drill and/or Hammers; Gantry (under 20,000 lbs); Tencher (wheel type or chain type having 8 inch or larger bucket); Milling Machine; Off-Road Material Haulers.

GROUP 5: Backfiller; Concrete Auto Breaker (large); Concrete

Finishing Machines (road type); Rubber Tired Roller;
 Concrete Batch Hopper; Concrete Conveyor Systems; Grout
 Pumps; Concrete Mixers (14S or over); Screw Type Pumps and
 Gypsum Pumps; Tractor, Bulldozer, End Loader (under 40 hp);
 Trencher (chain type, bucket under 8 inch); Industrial
 Locomotives; Rollers under 5 tons; Stump Grinder/Chipper
 (Large); Timber Equipment; Firemen (pile drivers and
 derricks); Personnel Hoist, Telehandler over 8000 lbs;
 Robotic Tool Carrier with or without attachments

GROUP 6: Tampers - Compactors (riding type); Assistant
 Engineer; A-Frames and Winch Trucks; Concrete Auto Breaker;
 Hydrohammers (small); Brooms and Sweepers; Hoist (tuggers
 under 5 tons); Boats (Tug, Safety, Work Barges, Launch);
 Shouldering Machine Operator; Prestress Machines; Screed
 Operator; Stone Crushers and Screening Plants; Screed
 Operators (milling machine), Farm or Industrial Tractor
 Mounted Equipment; Post Hole Digger; Fireman (asphalt
 plants); Air Compressors over 400 CFM; Generators, over 150
 KW; Augers (vertical and horizontal); Air, Electric,
 Hydraulic Jacks (slipform); Skid Steer Loaders (with or
 without attachments); Boiler Operators (temporary heat);
 Refrigeration Plant/Freeze Machines; Power Pack
 Vibratory/Ultra Sound Drivers and Extractors; Welding
 Machines; Heaters (mechanical); Pumps; Winches (small
 electric); Oiler and Greaser; Rotary Drill Tender;
 Conveyor; Forklifts/Telehandler 8000 lbs & under;
 Elevators: Automatic Hoists; Pumps (well points);
 Combination Small Equipment Operators

 IRON0008-005 06/01/2021

	Rates	Fringes
IRONWORKER.....	\$ 40.57	28.40

Paid Holidays: New Year's Day, Memorial Day, July 4th, Labor
 Day, Thanksgiving Day & Christmas Day.

 LAB00113-001 06/06/2022

	Rates	Fringes
LABORER		
(1) General Laborer (Including Plaster Tender)..	\$ 36.53	21.48
(2) Air & Electric Equipment, Mortar Mixer, Scaffold Builder, Erector, and Swing Stage.....	\$ 36.66	21.48
(3) Jackhammer Operator, Gunnite Machine Man.....	\$ 36.80	21.48
(4) Caisson Worker - Topman.	\$ 36.89	21.48
(5) Construction Specialist.	\$ 37.10	21.48
(6) Nozzleman.....	\$ 37.14	21.48
(7) Caisson Work.....	\$ 37.29	21.48
(8) Barco Tamper.....	\$ 37.94	21.48

 LAB00113-010 06/07/2021

	Rates	Fringes
Asbestos Laborer		

Asbestos Abatement
 [Preparation, removal, and
 encapsulation of hazardous
 materials from non-
 mechanical systems].....\$ 35.03 20.98

 PAIN0781-001 06/01/2022

 Rates Fringes

Painters:

(1) Brush, Roller.....\$ 37.40 24.80
 (2) Spray & Sandblast.....\$ 38.15 24.80
 (3) Drywall Taper/Finisher..\$ 37.75 24.80

 PAIN1204-002 06/01/2022

 Rates Fringes

GLAZIER.....\$ 40.00 24.94

 PLAS0599-004 06/01/2021

 Rates Fringes

CEMENT MASON/CONCRETE FINISHER...\$ 38.59 22.66

 PLAS0599-005 06/01/2017

 Rates Fringes

PLASTERER.....\$ 32.65 22.55

 PLUM0075-001 06/01/2021

 Rates Fringes

PLUMBER (Including HVAC work)....\$ 48.50 25.29

 PLUM0601-001 06/01/2022

 Rates Fringes

PIPEFITTER (Including HVAC
 work).....\$ 50.00 28.93

 SFWI0183-001 07/01/2022

 Rates Fringes

SPRINKLER FITTER.....\$ 48.50 29.31

 SHEE0018-001 06/01/2021

 Rates Fringes

Sheet Metal Worker (Including
 HVAC duct work and
 Technicians).....\$ 48.60 26.06

 TEAM0662-003 06/01/2022

 Rates Fringes

TRUCK DRIVER

1 & 2 Axles.....	\$ 34.07	24.95
3 or more Axles.....	\$ 34.22	24.95

 * SUWI2002-002 01/23/2002

	Rates	Fringes
Asbestos Worker/Heat and Frost Insulator.....	\$ 25.36	8.37
Laborers:		
Concrete Worker.....	\$ 16.34	3.59
Landscape.....	\$ 8.73 **	8.40
ROOFER.....	\$ 18.01	3.28
Tile & Marble Finisher.....	\$ 13.89 **	7.43

 WELDERS - Receive rate prescribed for craft performing operation to which welding is incidental.
 =====

** Workers in this classification may be entitled to a higher minimum wage under Executive Order 14026 (\$15.00) or 13658 (\$11.25). Please see the Note at the top of the wage determination for more information.

Note: Executive Order (EO) 13706, Establishing Paid Sick Leave for Federal Contractors applies to all contracts subject to the Davis-Bacon Act for which the contract is awarded (and any solicitation was issued) on or after January 1, 2017. If this contract is covered by the EO, the contractor must provide employees with 1 hour of paid sick leave for every 30 hours they work, up to 56 hours of paid sick leave each year. Employees must be permitted to use paid sick leave for their own illness, injury or other health-related needs, including preventive care; to assist a family member (or person who is like family to the employee) who is ill, injured, or has other health-related needs, including preventive care; or for reasons resulting from, or to assist a family member (or person who is like family to the employee) who is a victim of, domestic violence, sexual assault, or stalking. Additional information on contractor requirements and worker protections under the EO is available at <https://www.dol.gov/agencies/whd/government-contracts>.

Unlisted classifications needed for work not included within the scope of the classifications listed may be added after award only as provided in the labor standards contract clauses (29CFR 5.5 (a) (1) (ii)).

The body of each wage determination lists the classification and wage rates that have been found to be prevailing for the cited type(s) of construction in the area covered by the wage determination. The classifications are listed in alphabetical order of ""identifiers"" that indicate whether the particular rate is a union rate (current union negotiated rate for local), a survey rate (weighted average rate) or a union average rate (weighted union average rate).

Union Rate Identifiers

A four letter classification abbreviation identifier enclosed in dotted lines beginning with characters other than ""SU"" or ""UAVG"" denotes that the union classification and rate were prevailing for that classification in the survey. Example: PLUM0198-005 07/01/2014. PLUM is an abbreviation identifier of the union which prevailed in the survey for this classification, which in this example would be Plumbers. 0198 indicates the local union number or district council number where applicable, i.e., Plumbers Local 0198. The next number, 005 in the example, is an internal number used in processing the wage determination. 07/01/2014 is the effective date of the most current negotiated rate, which in this example is July 1, 2014.

Union prevailing wage rates are updated to reflect all rate changes in the collective bargaining agreement (CBA) governing this classification and rate.

Survey Rate Identifiers

Classifications listed under the ""SU"" identifier indicate that no one rate prevailed for this classification in the survey and the published rate is derived by computing a weighted average rate based on all the rates reported in the survey for that classification. As this weighted average rate includes all rates reported in the survey, it may include both union and non-union rates. Example: SULA2012-007 5/13/2014. SU indicates the rates are survey rates based on a weighted average calculation of rates and are not majority rates. LA indicates the State of Louisiana. 2012 is the year of survey on which these classifications and rates are based. The next number, 007 in the example, is an internal number used in producing the wage determination. 5/13/2014 indicates the survey completion date for the classifications and rates under that identifier.

Survey wage rates are not updated and remain in effect until a new survey is conducted.

Union Average Rate Identifiers

Classification(s) listed under the UAVG identifier indicate that no single majority rate prevailed for those classifications; however, 100% of the data reported for the classifications was union data. EXAMPLE: UAVG-OH-0010 08/29/2014. UAVG indicates that the rate is a weighted union average rate. OH indicates the state. The next number, 0010 in the example, is an internal number used in producing the wage determination. 08/29/2014 indicates the survey completion date for the classifications and rates under that identifier.

A UAVG rate will be updated once a year, usually in January of each year, to reflect a weighted average of the current negotiated/CBA rate of the union locals from which the rate is based.

WAGE DETERMINATION APPEALS PROCESS

1.) Has there been an initial decision in the matter? This can

be:

- * an existing published wage determination
- * a survey underlying a wage determination
- * a Wage and Hour Division letter setting forth a position on a wage determination matter
- * a conformance (additional classification and rate) ruling

On survey related matters, initial contact, including requests for summaries of surveys, should be with the Wage and Hour National Office because National Office has responsibility for the Davis-Bacon survey program. If the response from this initial contact is not satisfactory, then the process described in 2.) and 3.) should be followed.

With regard to any other matter not yet ripe for the formal process described here, initial contact should be with the Branch of Construction Wage Determinations. Write to:

Branch of Construction Wage Determinations
Wage and Hour Division
U.S. Department of Labor
200 Constitution Avenue, N.W.
Washington, DC 20210

2.) If the answer to the question in 1.) is yes, then an interested party (those affected by the action) can request review and reconsideration from the Wage and Hour Administrator (See 29 CFR Part 1.8 and 29 CFR Part 7). Write to:

Wage and Hour Administrator
U.S. Department of Labor
200 Constitution Avenue, N.W.
Washington, DC 20210

The request should be accompanied by a full statement of the interested party's position and by any information (wage payment data, project description, area practice material, etc.) that the requestor considers relevant to the issue.

3.) If the decision of the Administrator is not favorable, an interested party may appeal directly to the Administrative Review Board (formerly the Wage Appeals Board). Write to:

Administrative Review Board
U.S. Department of Labor
200 Constitution Avenue, N.W.
Washington, DC 20210

4.) All decisions by the Administrative Review Board are final.

=====

END OF GENERAL DECISION"



Wisconsin Department of Transportation

Division of Transportation Systems Development

Bureau of Project Development
4822 Madison Yards Way, 4th Floor South
Madison, WI 53705

December 7, 2022

Telephone: (608) 266-1631
Facsimile (FAX): (608) 266-8459

NOTICE TO ALL CONTRACTORS:

Proposal #16: 1000-57-70, FR-CRS-0068-2
Milwaukee Airport 2nd Platform
RR Crossing 393023R To 1200ft South
STH 119
Milwaukee County

Letting of December 13, 2022

This is Addendum No. 03, which provides for the following:

Special Provisions:

Revised Special Provisions	
Article No.	Description
7	Utilities.
53	Structural Steel, Item SPV.0085.01.

Schedule of Items:

Revised Bid Item Quantities					
Bid Item	Item Description	Unit	Proposal Total Prior to Addendum	Proposal Quantity Change (-)	Proposal Total After Addendum
SPV.0085.01	Structural Steel	LB	371,847	1,527	373,374

Plan Sheets:

Revised Plan Sheets	
Plan Sheet	Plan Sheet Title (brief description of changes to sheet)
7	Underdrain Detail Sheet
54	S-001 General Plan and Elevation (revised Seismic Design Category)
56	S-003 Typical Section and Quantities (Structural Steel Quantity)
60	S-102 Intermediate Level (Steel Framing Updates)
61	S-103 Pedestrian Bridge Level (Steel Framing Updates)

62	S-104 Top of Pedestrian Bridge Level (Steel Framing Updates)
63	S-105 Tower Roof Level (Steel Framing Updates)
68	S-301 Longitudinal Section – Grid D & F (Steel Framing Updates)
71	S-304 Transverse Section – Grid 2, 4 & 6 (Steel Framing Updates)
78	S-505 Roof Slab Plan & Details (Roof Deck Callout)
84	S-511 Platform Details
95	S-522 Grade Beam Reinforcement Plan (Slab thickness and clear cover)
96	S-523 Concrete Slab Details (1 of 2) (Construction joint callout)
224	E-401 Electrical Site Lighting Plan
226	E-600 Electrical Schedules
284	VT-100 Elevator Schedule

The responsibility for notifying potential subcontractors and suppliers of these changes remains with the prime contractor.

Sincerely,

Mike Coleman

Proposal Development Specialist
Proposal Management Section

ADDENDUM NO. 03

1000-57-70

December 7, 2022

Special Provisions

7. Utilities.

Replace entire section titled Roger Telecom - Communications with the following:

Rogers Telecom – Communications has existing communication facilities within the project limits. The existing underground communication facilities parallel and east of Track 1, Sta 98+00 – Sta 108+00, 22'-25' RT will be relocated. The new facility will be installed under the existing east platform from Track 1, Sta 98+00 - Sta 108+00, 9'-19' RT. The work is anticipated to start on December 26, 2022, and require an estimated 20 working days to complete.

53. Structural Steel, Item SPV.0085.01.

Replace entire section titled C.2 Fabrication with the following:

C.2 Fabrication

The structural steel for the bridge truss shall be fabricated by an approved fabricator selected from the Approved Products List (APL) for steel bridge primary members or prefabricated steel truss pedestrian bridges. The fabricator for the building structural steel and non-bridge truss structural steel components shall carry AISC certification for buildings. Submit name(s) and location(s) of fabricator(s) to be used to the engineer within 14 days of project award.

Schedule of Items

Attached, dated December 7, 2022, are the revised Schedule of Items Page 9.

Plan Sheets

The following 8½ x 11-inch sheets are attached and made part of the plans for this proposal:

Revised: 7, 54, 56, 60, 61, 62, 63, 68, 71, 78, 84, 95, 96, 224, 226, and 284

END OF ADDENDUM

15' MAINLINE TRACK

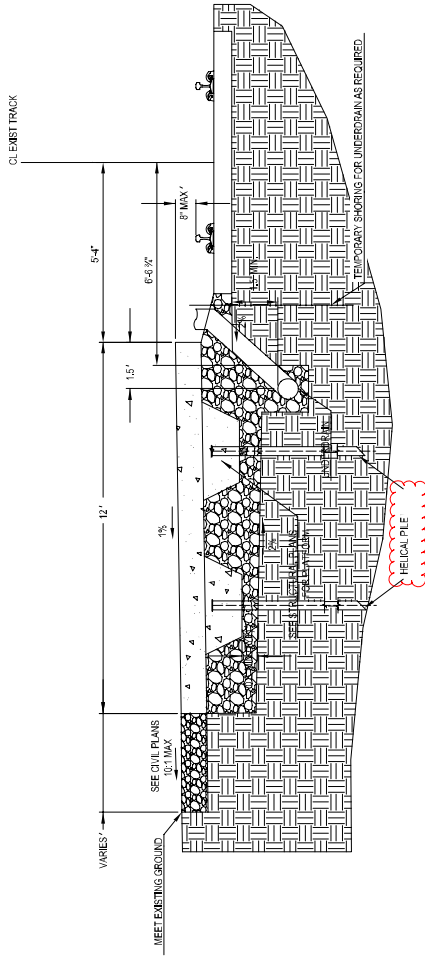

SHORING MUST BE DESIGNED FOR RAILROAD LIVE LOAD SURCHARGE IN ADDITION TO OSHA STANDARD LOADS FOR EXCAVATION IN ZONE A. APPLICABLE RAILROAD LIVE LOAD COEFFICIENTS SHALL BE USED. SEE SP-03 (06/08) TEMPORARY SHORING FOR MORE DETAILS.

2 TEMPORARY SHORING N.T.S.

1 PLATFORM SECTION N.T.S.

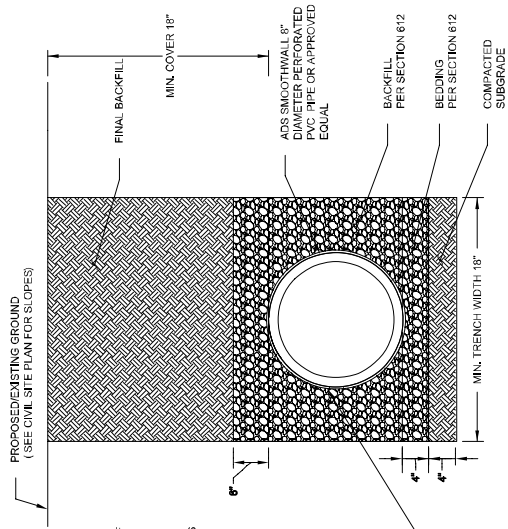

4 UNDERDRAIN TRENCH SECTION N.T.S.

NOTES:
 1. ALL PIPE SYSTEMS SHALL BE INSTALLED IN ACCORDANCE WITH THE MANUFACTURER'S INSTALLATION INSTRUCTIONS FOR UNDERGROUND INSTALLATION OF THERMOPLASTIC PIPE OR SEWERS AND OTHER GRAVITY FLOW APPLICATIONS.
 2. MEASURE SHOULD BE TAKEN TO PREVENT MIGRATION OF NATIVE FINES INTO BACKFILL MATERIALS WHEN REQUIRED.
 3. WHERE THE TRENCH BOTTOM IS UNDESIRABLE, THE TRENCH SHALL UNDERGUT TO A DEPTH REQUIRED BY THE ENGINEER AND REPLACE WITH SUITABLE FILL AND A GEOTEXTILE AS SPECIFIED BY THE ENGINEER.
 6. SUBGRADE AND BACKFILL SHALL BE COMPACTED TO 95% OF MAXIMUM DRY DENSITY PER SECTION 612. THE OPTIMUM MOISTURE CONTENT BASED ON STANDARD PROCTOR TEST.

GEOTEXTILE FABRIC PER SECTION 612

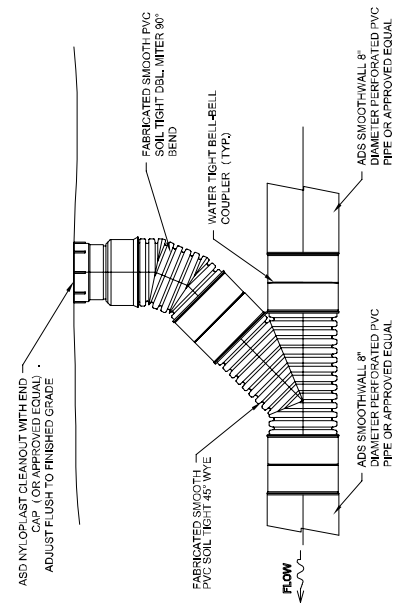

3 CLEAN OUT DETAIL N.T.S.

Addendum No. 03
 ID 1000-57-70
 Revised Sheet 7
 December 7, 2022

TOTAL ESTIMATED QUANTITIES

BID ITEM NUMBER	BID ITEM	UNIT	TOTALS
206-1001	EXCAVATION FOR STRUCTURES BRIDGES PEDESTRIAN BRIDGE	EACH	3
206-1002	BACKFILL GRANULAR GRADE 1	CY	303
210-1100	BACKFILL STRUCTURE TYPE A	CY	1082
502-0100	CONCRETE MASONRY BRIDGES	CY	718
502-0104	ADHESIVE ANCHORS 3/2-INCH	EACH	336
505-0400	BAR STEEL REINFORCEMENT IN STRUCTURES	LB	7100
505-0600	BAR STEEL REINFORCEMENT IN CONCRETE STRUCTURES	LB	50120
506-3009	WELDED STUD SHEAR CONNECTORS 3/8X3/8X1/4	EA	292
516-0500	AUTHERIZED MEMBRANE WATERPROOFING	SF	4800
520-3004	PAINTING FLOOR SYSTEMS	EA	4800
520-3005	PAINTING WALL SYSTEMS	EA	4800
SPV-0060.01	DESIGN ELECTRICAL GENERATOR SETS	EACH	1
SPV-0060.02	CANOPY COLUMN ANCHOR ROD ASSEMBLIES	EACH	76
SPV-0060.03	TOWER COLUMN ANCHOR ROD ASSEMBLIES	EACH	46
SPV-0060.04	TRANSFORMER SWITCHES	EACH	1
SPV-0060.05	TRACTION ELECTRICITY	EACH	4
SPV-0060.06	TRACTION ELECTRICITY	EACH	4
SPV-0060.07	DOORS AND DOOR HARDWARE	EACH	22
SPV-0060.16	FALL RESTRAINT SYSTEM	EACH	1
SPV-0060.17	HVAL WORK	EACH	1
SPV-0060.18	LIGHTING	EACH	1
SPV-0060.19	GENERAL ELECTRICAL WORK	EACH	1
SPV-0060.20	FIRE ALARM SYSTEM	EACH	1
SPV-0060.21	LIGHTNING PROTECTION FOR STRUCTURES	EACH	1
SPV-0060.22	PLUMBING WORK	EACH	1
SPV-0060.23	STAIRS	EACH	1
SPV-0060.24	ROUGH CARPENTRY	EACH	1
SPV-0060.25	METAL FABRICATIONS	EACH	1
SPV-0060.26	GYPSUM BOARD PARTITIONS AND ASSEMBLIES	EACH	1
SPV-0060.27	CEILING	EACH	1
SPV-0060.28	INTERIOR AND EXTERIOR SIGNAGE	EACH	1
SPV-0060.29	OTHER ARCHITECTURAL WORK	EACH	1
SPV-0060.30	FIRE SUPPRESSION	EACH	1
SPV-0060.31	PIDS, COMMUNICATIONS, AND SECURITY WORK	EACH	1
SPV-0060.32	WHELGUARD, AFF-ENCLOSURE, NEW AND RELOCATIONS	EACH	1
SPV-0060.01	PAINTING PIPE	LB	373374
SPV-0090.02	DRILLED SHAFT FOUNDATIONS 24-INCH	LF	555
SPV-0090.03	HELICAL PILE	LF	2190**
SPV-0165.01	MASONRY AND CAST STONE WORK	SF	9916
SPV-0165.02	STEEL DECKING	SF	8115
SPV-0165.03	ALUMINUM AND GLASS CURTAIN WALLS	SF	7278
SPV-0165.04	ROOFING AND ACCESSORIES	SF	11995
SPV-0165.05	EXTERIOR METAL PANELS	SF	3274
SPV-0165.06	LOUVERS	SF	3274
SPV-0165.07	FINISHES	SF	20973
SPV-0165.08	TEMPORARY SHORING RAILROAD	SF	2400

SEE CIVIL PLANS FOR OTHER BID ITEMS INCLUDED IN THIS CONTRACT.

ALL CONCRETE FOR TOWER FLOOR SLABS, ELEVATED AND ON GRADE FOOTINGS, BRACKETS FOR TOWER FLOOR SLABS, AND CONCRETE FOR BRACKETS FOR TOWER FLOOR SLABS, SHALL BE PROTECTED WITH CONCRETE MASSIVE BRIDGES. CONCRETE FOR BRACKETS IS INCLUDED IN THE BID ITEM "DRILLED SHAFT FOUNDATIONS 24-INCH".

** HELICAL PILE QUANTITY IS BASED ON AN ASSUMED LENGTH OF 15'. ACTUAL LENGTH WILL BE BASED ON THE DESIGN BY THE SUPPLIER.

FOUNDATION NOTES

PROVIDE SHEETING BRACING, AND UNDERPINNING TO PRESERVE ADJACENT STRUCTURE, AS REQUIRED.

FOUNDATIONS SHALL NOT BE PLACED IN WATER OR IN FROZEN GROUND. PROVIDE A WELL COMPACTED SELECT GRAVEL BASE COURSE CONFORMING TO THE SPECIFICATIONS UNDER ALL SLABS ON GRADE.

ALL REQUIRED INSERTS SLEEVES, CONDUITS, EMBEDMENT AND PENETRATIONS MUST BE VERIFIED WITH RESPECTIVE TRADES BEFORE CASTING CONCRETE.

DOWELS FROM FOOTINGS INTO PIERS, COLUMNS, BUTTRESSES OR WALLS SHALL BE THE SAME SIZE AND NUMBER AS REINFORCEMENT IN PIERS, COLUMNS, BUTTRESSES OR WALLS ABOVE, EXCEPT AS OTHERWISE SHOWN.

CONTRACTOR SHALL PROVIDE CONTINUOUS DRAINAGE TO CONTROL SURFACE WATER, AS REQUIRED DURING CONSTRUCTION.

ALL FOOTINGS SHALL BE CENTERED UNDER SUPPORTED MEMBERS, UNLESS NOTED OTHERWISE ON PLANS.

DO NOT PLACE BACKFILL AGAINST WALLS UNTIL ALL SLABS AND WALL BRACING ARE IN PLACE AND AFTER CONCRETE HAS ATTAINED DESIGN STRENGTH, SHORE AND/OR BRACE WALLS AS REQUIRED IF BACKFILLING OPERATIONS ARE TO BE CARRIED OUT PRIOR TO PLACEMENT OF FLOOR SLABS.

PLACE BACKFILL AGAINST RETAINING WALLS - DESIGNED AS CANTILEVERED ARE IN PLACE.

WHERE BACKFILL IS TO BE PLACED ON BOTH SIDES OF FOUNDATIONS TO PROVIDE ALL ROUND BACKFILLING, CONTRACTOR SHALL PROVIDE TO ELIMINATE LATERAL LOADS EFFECTS, OR PROVIDE NECESSARY TEMPORARY LATERAL SUPPORT TO THE TOP OF THE WALL UNTIL PERMANENT SUPPORT IS INSTALLED.

BACKFILL MATERIAL SHALL BE COMPACTED TO 95% OF MAXIMUM DENSITY, AS DETERMINED BY THE MODIFIED PROCTOR METHOD (ASTM D1557), IN LIFTS NOT EXCEEDING 6 INCHES.

BACKFILL MATERIAL AGAINST RETAINING WALLS - DESIGNED AS CANTILEVERED SHALL BE GRANULAR FILL.

HELICAL PILE DESIGN CRITERIA

UNFACTORED AXIAL LOADS:
DL = 10 KIPS
LL = 10 KIPS

MAXIMUM PILE SETTLEMENT = 1/4"

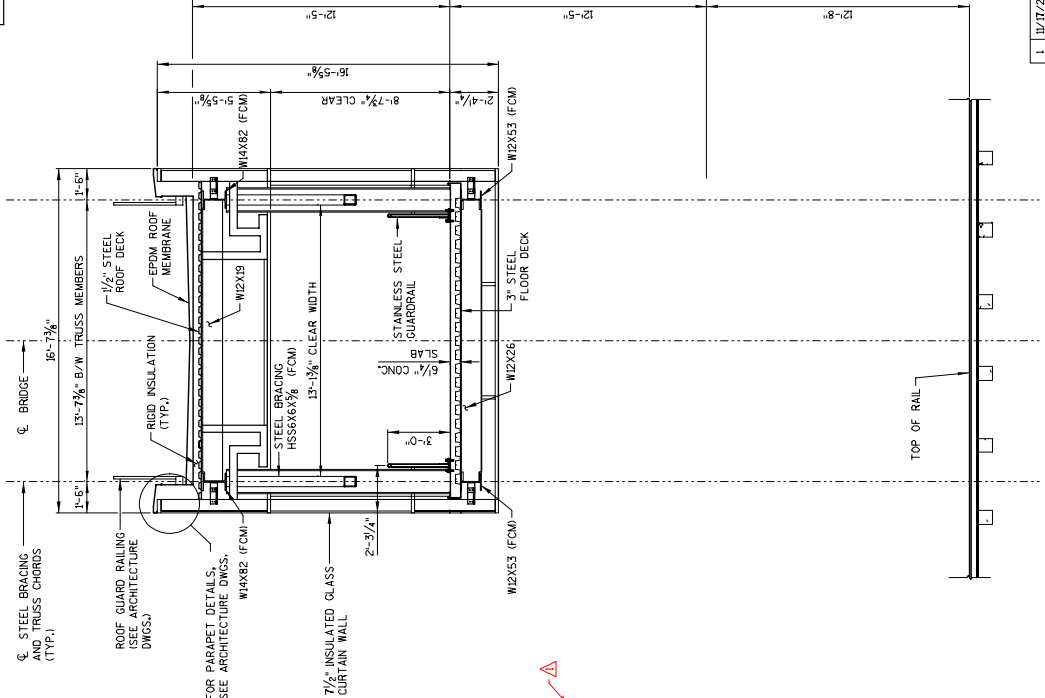

1. TYPICAL BRIDGE SECTION

Addendum No. 03
ID 1000-57-70
Revised Sheet 56
December 7, 2022

NO.	DATE	REVISION	BY
1	12/17/22	STRUCTURAL STEEL QTY. UPDATE	CEB

STATE OF WISCONSIN
DEPARTMENT OF TRANSPORTATION

STRUCTURAL

DESIGNED BY: CEB
CHECKED BY: MJA

TYPICAL SECTION AND QUANTITIES

SHEET 5-003

56

Addendum No. 03
ID 1000-57-70
Revised Sheet 61
December 7, 2022

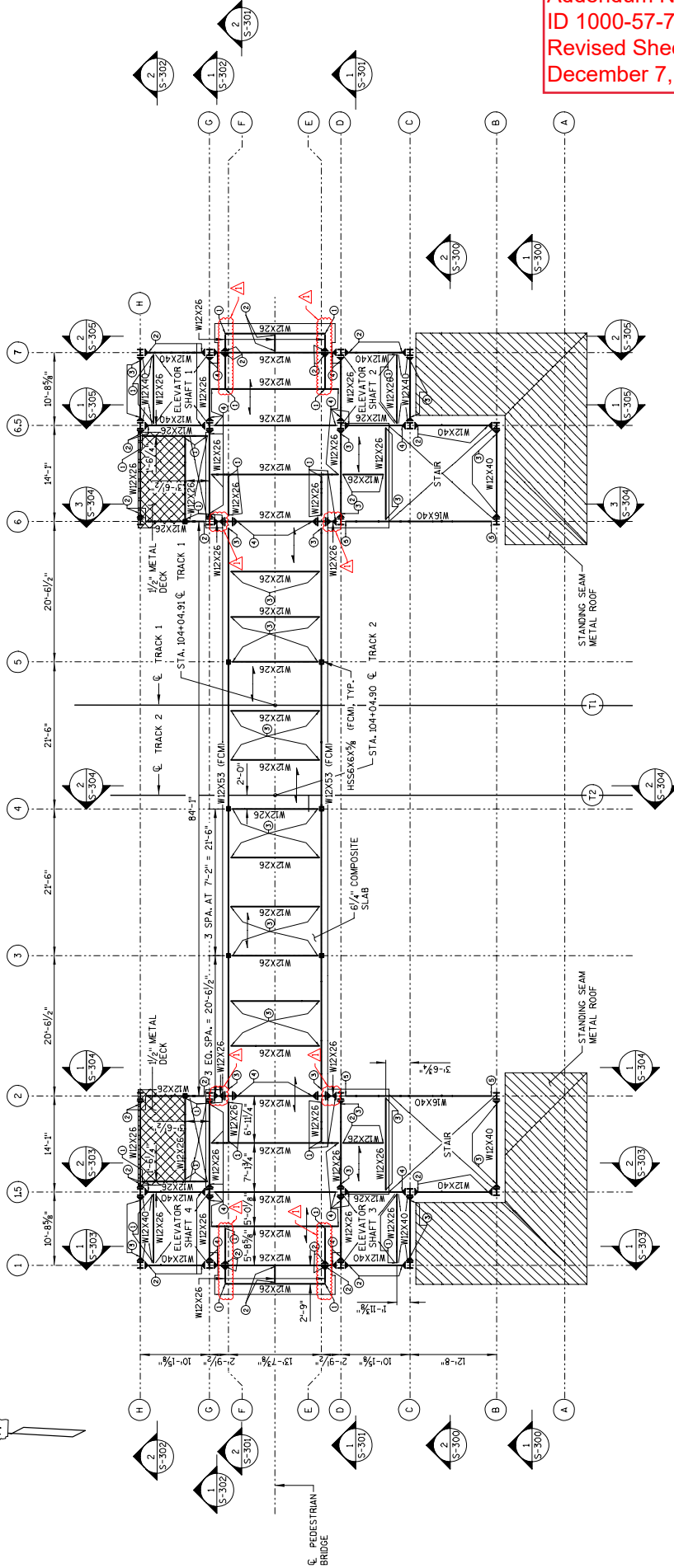

1 PEDESTRIAN BRIDGE LEVEL
NTS

LEGEND

- DIRECTION OF COMPOSITE STEEL DECKING
- DIRECTION OF TYPE B 1.5" x 20 GA. METAL ROOF DECKING
- FLAT ROOF
- SLOPED ROOF

- LEGEND:**
- 1 SHEAR LOAD = 5 KIPS
 - 2 SHEAR LOAD = 10 KIPS
 - 3 SHEAR LOAD = 15 KIPS
 - 4 SHEAR LOAD = 20 KIPS
 - 5 SHEAR LOAD = 25 KIPS
- NOTE: FORCES SHOWN ARE ENVELOPE FORCES OF ALL ASSET-10 LOAD COMBINATIONS.

NO.	DATE	MOMENT	CONN.	LEGEND	UPDATE	CEB
1	12/17/22					
STATE OF WISCONSIN DEPARTMENT OF TRANSPORTATION						
STRUCTURAL						
DESIGNED BY			CHECKED BY			M.J.A.
PEDESTRIAN BRIDGE						SHEET S-103
						61

STATE PROJECT NUMBER
1000-57-70

Addendum No. 03
ID 1000-57-70
Revised Sheet 63
December 7, 2022

2

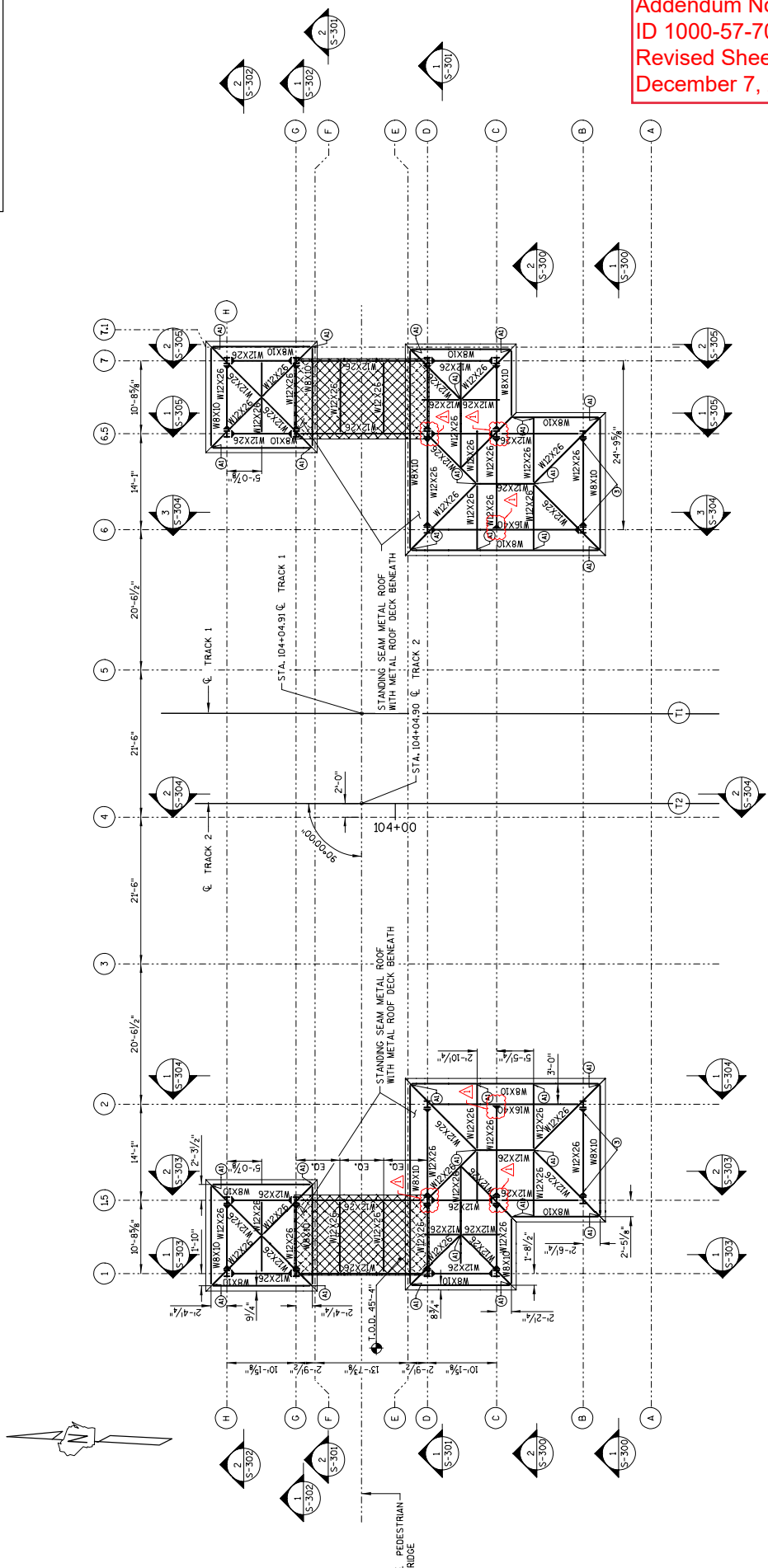

1. TOWER ROOF LEVEL
NTS

NO.	DATE	REVISION	BY
1	12/1/22	MOMENT CONN., LEGEND UPDATE	CEB

STATE OF WISCONSIN
DEPARTMENT OF TRANSPORTATION

STRUCTURAL

DESIGNED BY: CEB
CHECKED BY: MJA

TOWER ROOF LEVEL

SHEET 5-105

63

LEGEND

- DIRECTION OF COMPOSITE STEEL DECKING
- DIRECTION OF TYPE B 15'-20 GA. METAL ROOF DECKING
- FLAT ROOF
- SLOPED ROOF

- LEGEND:**
- 1 SHEAR LOAD = 5 KIPS
 - 2 SHEAR LOAD = 10 KIPS
 - 3 SHEAR LOAD = 15 KIPS
 - 4 SHEAR LOAD = 20 KIPS
 - 5 SHEAR LOAD = 25 KIPS
 - 6 SHEAR LOAD = 28 KIPS
 - 7 WELDED CONNECTION
- NOTES:**
- CONNECTION SHEAR LOAD = 5 KIPS UNLESS SHOWN OTHERWISE
- NOTES:** FORCES SHOWN ARE ENVELOPE FORCES OF ALL ACCEPTED LOAD COMBINATIONS.

2

Addendum No. 03
 ID 1000-57-70
 Revised Sheet 84
 December 7, 2022

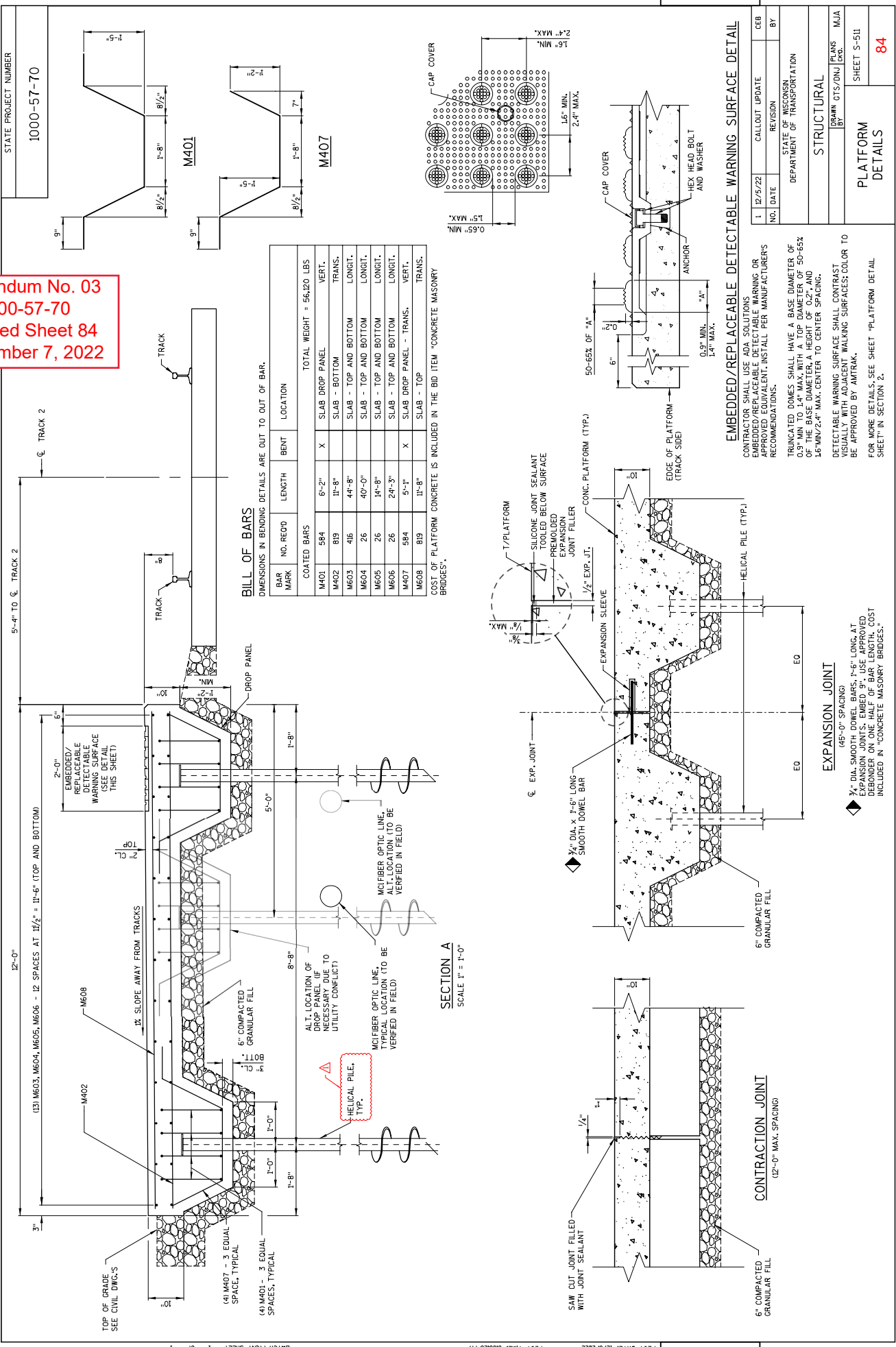

BILL OF BARS

BAR MARK	NO. REQ'D	LENGTH	BENT	LOCATION	TOTAL WEIGHT = 56,120 LBS
M401	584	6'-2"	X	SLAB DROP PANEL VERT.	
M402	819	11'-8"		SLAB - BOTTOM TRANS.	
M603	416	44'-8"		SLAB - TOP AND BOTTOM LONGIT.	
M604	26	40'-0"		SLAB - TOP AND BOTTOM LONGIT.	
M605	26	14'-8"		SLAB - TOP AND BOTTOM LONGIT.	
M606	26	24'-3"		SLAB - TOP AND BOTTOM LONGIT.	
M407	584	5'-1"	X	SLAB DROP PANEL - TRANS.	
M608	819	11'-8"		SLAB - TOP TRANS.	

COST OF PLATFORM CONCRETE IS INCLUDED IN THE BID ITEM "CONCRETE MASONRY BRIDGES".

SECTION A
 SCALE 1" = 1'-0"

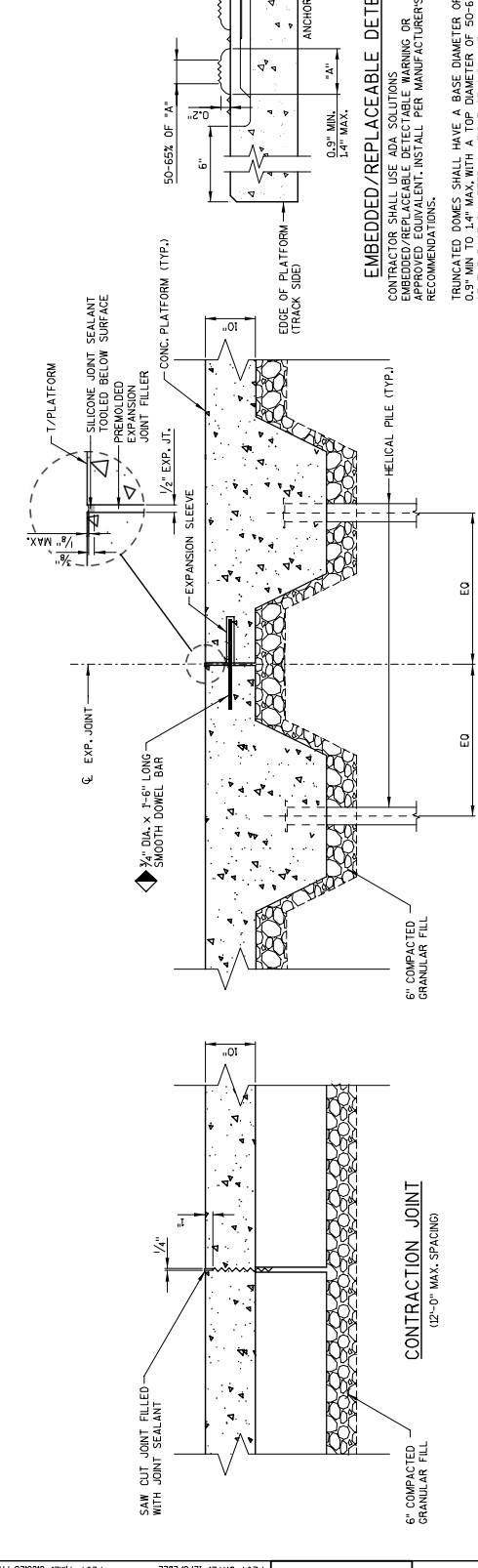

EXPANSION JOINT
 (45'-0" SPACING)

3/4" DIA. SMOOTH DOMEL BARS, 1'-6" LONG AT EXPANSION JOINTS. EMBED 9", USE APPROVED DEBRIDER ON ONE HALF OF BAR LENGTH. COST INCLUDED IN "CONCRETE MASONRY BRIDGES."

EMBEDDED/REPLACEABLE DETECTABLE WARNING SURFACE DETAIL

CONTRACTOR SHALL USE ABOVE SOLUTIONS FOR DETECTABLE WARNING OR APPROVED EQUIVALENT. INSTALL PER MANUFACTURER'S RECOMMENDATIONS.
 TRUNCATED DOMES SHALL HAVE A BASE DIAMETER OF 1.6" MIN. TO 2.4" MAX. AND A HEIGHT OF 0.2" AND 1.6" MIN/2.4" MAX. CENTER TO CENTER SPACING.
 DETECTABLE WARNING SURFACE SHALL CONTRAST VISIBLY WITH ADJACENT WALKING SURFACES COLOR TO BE APPROVED BY AMTRAK.
 FOR MORE DETAILS, SEE SHEET "PLATFORM DETAILS SHEET" IN SECTION 2.

NO.	DATE	CALLOUT UPDATE	CEB
1	12/5/22	REVISION	BY
STATE OF WISCONSIN DEPARTMENT OF TRANSPORTATION			
STRUCTURAL			
DESIGNED BY: [Signature]		CHECKED BY: [Signature]	
DRAWN BY: [Signature]		SCALE: AS SHOWN	
PROJECT NO. 1000-57-70		SHEET 5-511	
PROJECT NAME: BRIDGE		DATE: 12/5/22	

PLATFORM DETAILS
 84

STATE PROJECT NUMBER
 1000-57-70

5'-0" TO CL TRACK 2

12'-0"

(13) M603, M604, M605, M606 - 12 SPACES AT 11/2" = 11'-6" (TOP AND BOTTOM)

M402

M608

TOP OF GRADE SEE CIVIL DWG.'S

1'-0"

1'-0"

1'-0"

1'-0"

1'-0"

1'-0"

1'-0"

1'-0"

1'-0"

1'-0"

1'-0"

1'-0"

1'-0"

1'-0"

1'-0"

1'-0"

1'-0"

1'-0"

1'-0"

1'-0"

1'-0"

1'-0"

1'-0"

1'-0"

1'-0"

1'-0"

1'-0"

1'-0"

1'-0"

1'-0"

1'-0"

1'-0"

1'-0"

1'-0"

1'-0"

1'-0"

1'-0"

1'-0"

1'-0"

1'-0"

STATE PROJECT NUMBER
1000-57-70

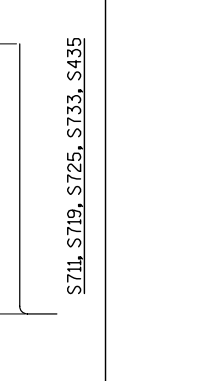
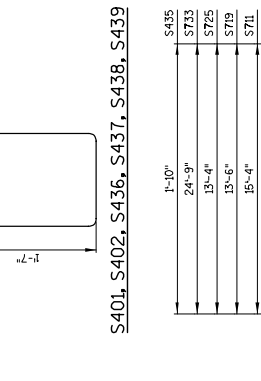
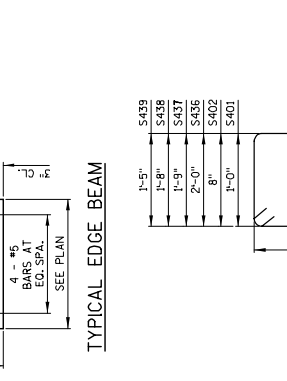
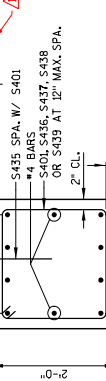
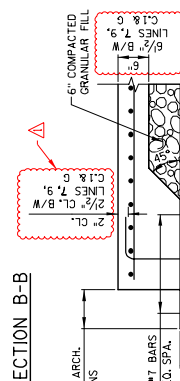
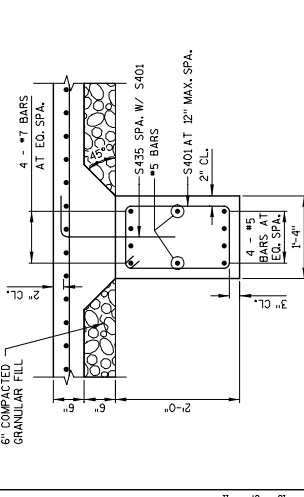
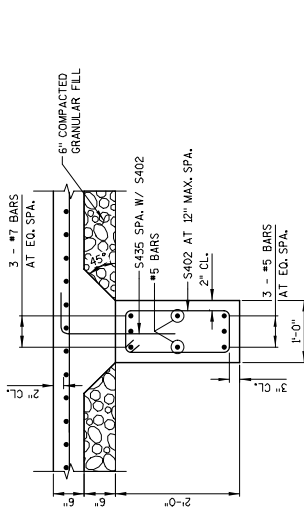
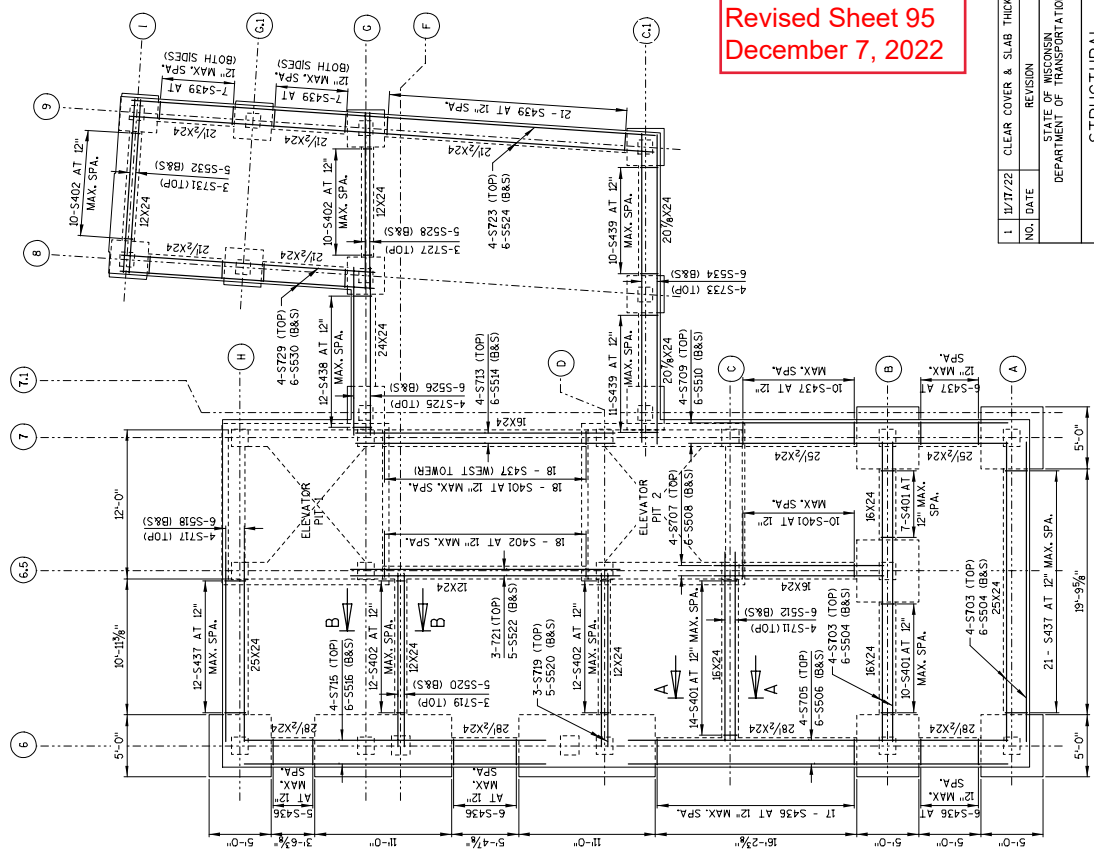

BILL OF BARS

MARK	NO. REQD	LENGTH	BAR BENT SERIES	LOCATION
TOTAL WEIGHT = 11,010 LBS				
NONCOATED BARS				
S401	100	5 - 8	X	GRADE BEAM STIRRUP
S402	104	5 - 0	X	VERT
S703	16	24 - 2		TOWER GRADE BEAM (TOP)
S704	24	22 - 4		TOWER GRADE BEAM (BOTTOM & SIDES)
S705	8	36 - 7		TOWER GRADE BEAM (TOP)
S706	12	28 - 9		TOWER GRADE BEAM (BOTTOM & SIDES)
S707	8	13 - 10		TOWER GRADE BEAM (TOP)
S708	12	12 - 0		TOWER GRADE BEAM (BOTTOM & SIDES)
S709	8	23 - 10		TOWER GRADE BEAM (TOP)
S710	12	22 - 0		TOWER GRADE BEAM (BOTTOM & SIDES)
S711	8	17 - 9	X	TOWER GRADE BEAM (TOP)
S712	12	14 - 1		TOWER GRADE BEAM (BOTTOM & SIDES)
S713	8	20 - 11		TOWER GRADE BEAM (TOP)
S714	12	19 - 1		TOWER GRADE BEAM (BOTTOM & SIDES)
S715	8	24 - 4		TOWER GRADE BEAM (TOP)
S716	12	21 - 6		TOWER GRADE BEAM (BOTTOM & SIDES)
S717	8	15 - 4		TOWER GRADE BEAM (TOP)
S718	12	13 - 6		TOWER GRADE BEAM (BOTTOM & SIDES)
S719	12	16 - 9	X	TOWER GRADE BEAM (TOP)
S720	20	12 - 3		TOWER GRADE BEAM (BOTTOM & SIDES)
S721	6	20 - 11		TOWER GRADE BEAM (TOP)
S722	10	19 - 1		TOWER GRADE BEAM (BOTTOM & SIDES)
S723	4	42 - 2		VESTIBULE GRADE BEAM (TOP)
S724	6	40 - 4		VESTIBULE GRADE BEAM (BOTTOM & SIDES)
S725	4	16 - 7	X	VESTIBULE GRADE BEAM (TOP)
S726	6	12 - 2		VESTIBULE GRADE BEAM (BOTTOM & SIDES)
S727	3	13 - 3		VESTIBULE GRADE BEAM (TOP)
S728	5	11 - 5		VESTIBULE GRADE BEAM (BOTTOM & SIDES)
S729	4	20 - 6		VESTIBULE GRADE BEAM (TOP)
S730	6	18 - 8		VESTIBULE GRADE BEAM (BOTTOM & SIDES)
S731	3	13 - 2		VESTIBULE GRADE BEAM (TOP)
S732	5	11 - 4		VESTIBULE GRADE BEAM (BOTTOM & SIDES)
S733	4	27 - 4		VESTIBULE GRADE BEAM (TOP)
S734	6	22 - 11		VESTIBULE GRADE BEAM (BOTTOM & SIDES)
S435	470	2 - 5	X	GRADE BEAM DOVEL
S436	68	7 - 8	X	GRADE BEAM STIRRUP
S437	116	7 - 2	X	GRADE BEAM STIRRUP
S438	12	7 - 0	X	GRADE BEAM STIRRUP
S439	70	6 - 6	X	GRADE BEAM STIRRUP

Addendum No. 03
ID 1000-57-70
Revised Sheet 95
December 7, 2022

1	12/17/22	CLEAR COVER & SLAB THICK.	CEB
NO.	DATE	REVISION	BY
STATE OF WISCONSIN DEPARTMENT OF TRANSPORTATION			
STRUCTURAL			
DRAWN BY		PLANS CHECKED BY	M.J.A.
STRUCTURAL		CEB	CEB
GRADE BEAM REINFORCEMENT PLAN			SHEET 5-522
			95

PLAN
(EAST TOWER SHOWN, WEST TOWER SIMILARI)

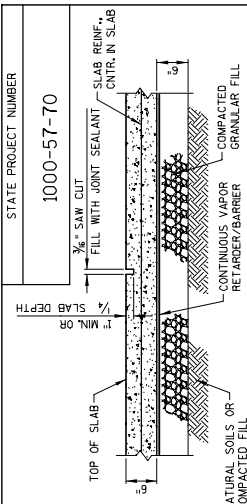

SLAB ON GRADE CONSTRUCTION

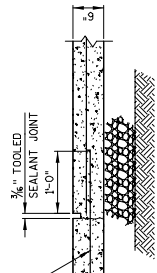

SLAB ON GRADE CONSTRUCTION JOINT

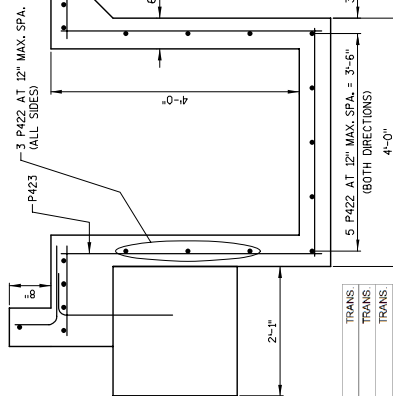

SECTION A-A

NOTES:
FOR CURB DIMENSIONS, SEE SHEET S-101 AND ARCHITECTURE PLANS.

NO.	DATE	REVISION	BY
1	12/17/22	CONSTRUCTION JOINT CALLOUT	CEB

DEPARTMENT OF TRANSPORTATION

STRUCTURAL

DESIGNED BY: **CEB**
CHECKED BY: **MJA**

CONCRETE SLAB DETAILS (1 OF 2)

SHEET S-523

96

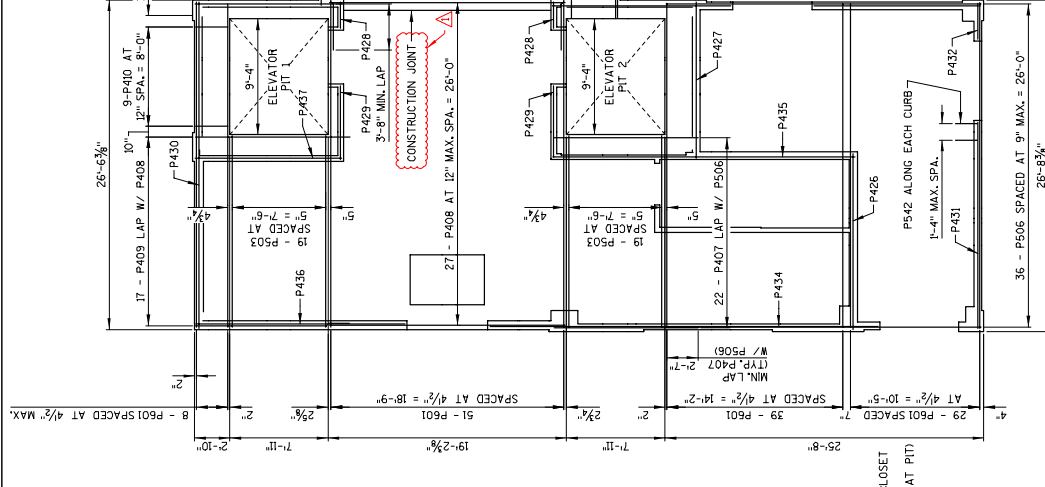
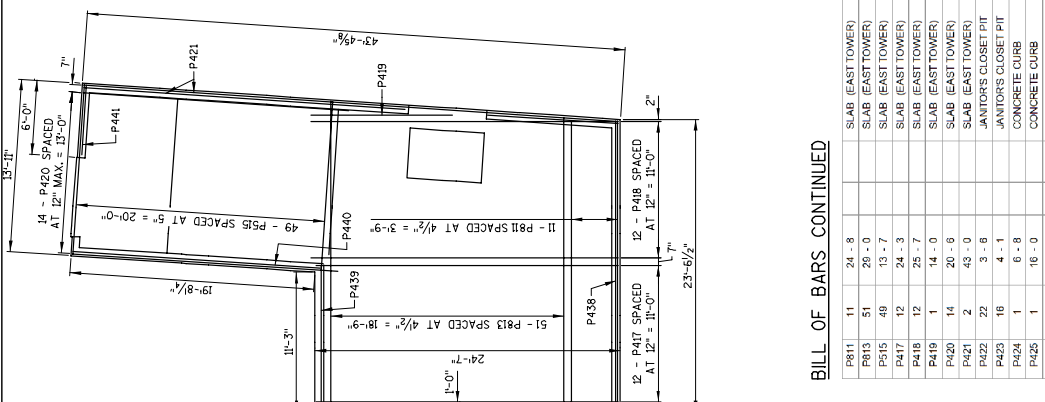

BILL OF BARS CONTINUED

MARK NO.	RECD	LENGTH	BAR	BENT SERIES	LOCATION	TOTAL WEIGHT = 21,140 LBS
P811	11	24 - 8			SLAB (EAST TOWER)	TRANS
P813	51	28 - 0			SLAB (EAST TOWER)	TRANS
P515	49	13 - 7			SLAB (EAST TOWER)	TRANS
P417	12	24 - 3			SLAB (EAST TOWER)	LONG
P418	12	25 - 7			SLAB (EAST TOWER)	LONG
P419	1	14 - 0			SLAB (EAST TOWER)	LONG
P420	14	20 - 6			SLAB (EAST TOWER)	LONG
P421	2	43 - 0			SLAB (EAST TOWER)	LONG
P422	22	3 - 8			JANITORS CLOSET PIT	HORIZ
P423	16	4 - 1			JANITORS CLOSET PIT	VERT
P424	1	6 - 8			CONCRETE CURB	TRANS
P425	1	16 - 0			CONCRETE CURB	TRANS
P426	2	14 - 1			CONCRETE CURB	TRANS
P427	2	12 - 8			CONCRETE CURB	TRANS
P428	4	2 - 1			CONCRETE CURB	TRANS
P429	4	5 - 8			CONCRETE CURB	TRANS
P430	2	26 - 2			CONCRETE CURB	TRANS
P431	1	16 - 8			CONCRETE CURB	TRANS
P432	1	3 - 0			CONCRETE CURB	TRANS
P433	2	32 - 8			CONCRETE CURB	LONG
P434	2	31 - 3			CONCRETE CURB	LONG
P435	2	24 - 3			CONCRETE CURB	LONG
P436	2	16 - 9			CONCRETE CURB	LONG
P437	2	11 - 10			CONCRETE CURB	LONG
P438	1	24 - 8			CONCRETE CURB	LONG
P439	1	5 - 8			CONCRETE CURB	LONG
P542	407	2 - 3		X	CONCRETE CURB	HORIZ

WEST TOWER

EAST TOWER

MARK NO.	RECD	LENGTH	BAR	BENT SERIES	LOCATION	TOTAL WEIGHT = 21,140 LBS
P601	251	28 - 0			SLAB (EAST & WEST TOWER)	TRANS
P503	38	15 - 4			SLAB (EAST & WEST TOWER)	TRANS
P506	72	25 - 2			SLAB (EAST & WEST TOWER)	LONG
P407	44	11 - 7			SLAB (EAST & WEST TOWER)	LONG
P408	54	18 - 10			SLAB (EAST & WEST TOWER)	LONG
P409	34	12 - 3			SLAB (EAST & WEST TOWER)	LONG
P410	18	2 - 6			SLAB (EAST & WEST TOWER)	LONG

**Addendum No. 03
ID 1000-57-70
Revised Sheet 96
December 7, 2022**

STATE PROJECT NUMBER
1000-57-70

KEYED NOTES - POWER PLAN

- 1 PROVIDE WEATHERPROOF ELECTRONIC HORN AND STROBE WITH JENKINS COR. SOUTH PLATFORMS HORN/STROBE CALL TO WORK. AND SOUTH PLATFORMS HORN/STROBE SHALL ALARM WHEN ELEVATOR FAILS. INTERCONNECT WITH ELEVATOR CONTROLLER. FURNISH AND INSTALL MINIMUM 2#12 AND 1#12 GROUND IN 3/4" CONDUIT FOR HORN/STROBE.

GENERAL NOTES - SITE PLAN

- 1 REFER TO DRAWING E-001 FOR ELECTRICAL SYMBOLS, ABBREVIATIONS, AND GENERAL NOTES.
- 2 REFER TO PANEL SCHEDULES DRAWINGS FOR CIRCUIT WIRING INFORMATION.

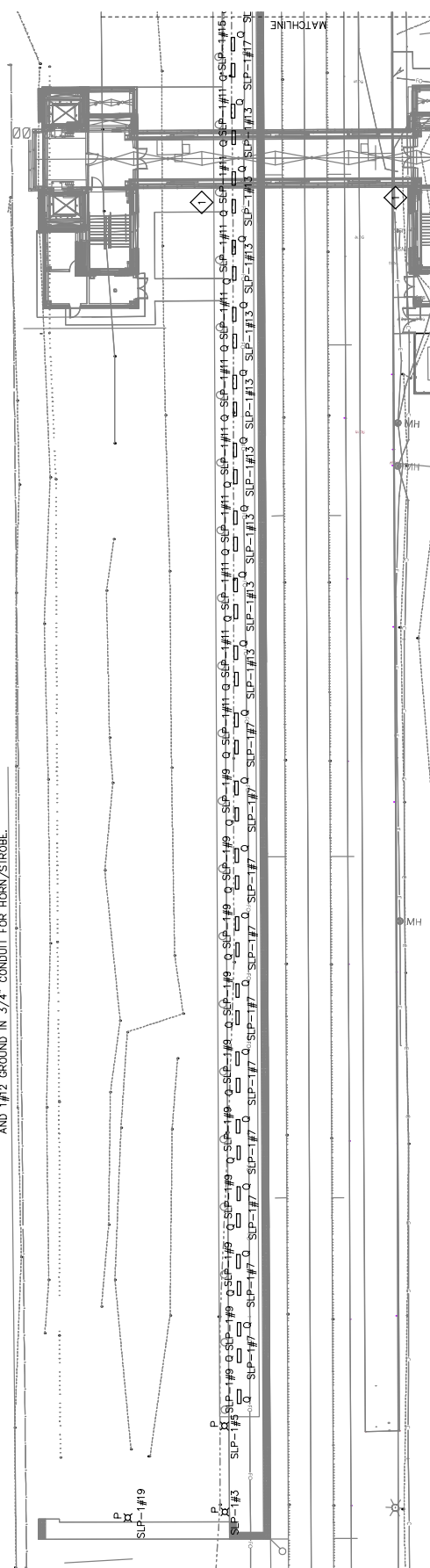

Addendum No. 03
ID 1000-57-70
Revised Sheet 224
December 7, 2022

1 ELECTRICAL SITE LIGHTING PLAN
SCALE: 1/32"=1'-0"

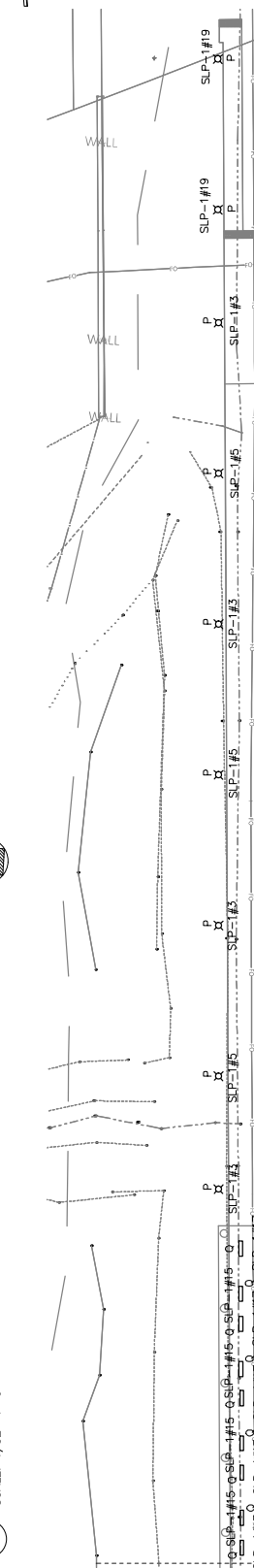

2 ELECTRICAL SITE LIGHTING PLAN
SCALE: 1/32"=1'-0"

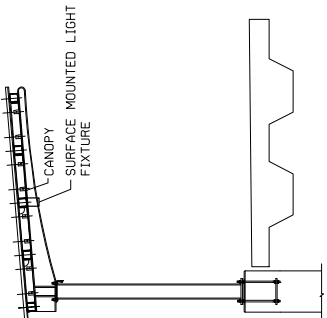

1 CANOPY FIXTURE MOUNTING DETAIL
SCALE: NONE

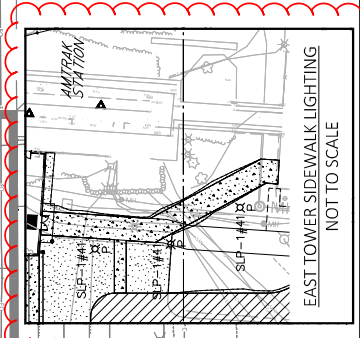

2 EAST TOWER SIDEWALK LIGHTING
NOT TO SCALE

NO.	DATE	REVISION	BY
STATE OF WISCONSIN DEPARTMENT OF TRANSPORTATION			
ELECTRICAL			
BY: JMM		CHECKED: PH	
DATE: 12/07/22		SCALE: AS NOTED	
SHEET E-401		224	
ELECTRICAL SITE LIGHTING PLAN			

SCALE = AS NOTED

STATE PROJECT NUMBER
1000-57-70

KEYED NOTES -
PANEL SCHEDULES

NO. DESCRIPTION

- SHORT CIRCUIT RATING BASED ON PRELIMINARY CALCULATIONS AND ASSUMPTIONS. ACTUAL SHORT CIRCUIT RATING SHALL BE BASED ON CONTRACTOR SUBMITTED SHORT CIRCUIT STUDY PER SPECIFICATIONS.
- INDICATED PANEL SHALL BE A SMART PANEL (CONTROLLABLE CIRCUIT BREAKERS) WITH INTEGRAL MAINS OVERCURRENT PROTECTION, EATON POW-R-COMMAND OR APPROVED EQUAL.
- CIRCUIT BREAKER SHALL BE LOCKABLE TYPE.
- GFCI TYPE CIRCUIT BREAKER FOR PUMP.
- COORDINATE EXACT IT EQUIPMENTS REQUIREMENTS WITH LOW VOLTAGE CONTRACTOR.
- PROVIDE 2#8 & 1#10 GND. IN 3/4" & 1#12 GND. IN 3/4" CONDUIT BETWEEN INDOOR AND OUTDOOR UNITS.
- PROVIDE 3#10 & 1#10 GND. IN 3/4" CONDUIT FOR CIRCUIT.
- CIRCUITS FOR RELOCATION OF EXISTING CANOPY LIGHT CIRCUITS UPON COMPLETION OF BUILDING POWER. REFER TO SITE PLAN ON DRAWING E-400 FOR FURTHER INFORMATION.

Addendum No. 03
ID 1000-57-70
Revised Sheet 226
December 7, 2022

1 SCR: 10K AIC		SLP-1		120/208 V, 3 PH., 4 W., 100 A BUS, 150 A MCB		
A	B	C	DESCRIPTION	A	B	C
350			BRIDGE CANOPY LTG	20A-1	1	20A-1
	375		PLATFORM LIGHTING	20A-1	3	20A-1
	390		PLATFORM LIGHTING	20A-1	5	20A-1
	200		PLAT CANOPY LTG	20A-1	8	20A-1
	200		PLAT CANOPY LTG	20A-1	9	20A-1
	225		PLAT CANOPY LTG	20A-1	10	20A-1
	125		PLAT CANOPY LTG	20A-1	11	20A-1
	150		PLAT CANOPY LTG	20A-1	12	20A-1
	450		EX CANOPY LTG	20A-1	13	20A-1
	450		EX CANOPY LTG	20A-1	14	20A-1
	450		EX CANOPY LTG	20A-1	15	20A-1
	450		EX CANOPY LTG	20A-1	16	20A-1
	450		EX CANOPY LTG	20A-1	17	20A-1
	450		EX CANOPY LTG	20A-1	18	20A-1
	450		EX CANOPY LTG	20A-1	19	20A-1
	450		EX CANOPY LTG	20A-1	20	20A-1
	450		EX CANOPY LTG	20A-1	21	20A-1
	450		EX CANOPY LTG	20A-1	22	20A-1
	450		EX CANOPY LTG	20A-1	23	20A-1
	450		EX CANOPY LTG	20A-1	24	20A-1
	450		EX CANOPY LTG	20A-1	25	20A-1
	450		EX CANOPY LTG	20A-1	26	20A-1
	450		EX CANOPY LTG	20A-1	27	20A-1
	450		EX CANOPY LTG	20A-1	28	20A-1
	450		EX CANOPY LTG	20A-1	29	20A-1
	450		EX CANOPY LTG	20A-1	30	20A-1
	450		EX CANOPY LTG	20A-1	31	20A-1
	450		EX CANOPY LTG	20A-1	32	20A-1
	450		EX CANOPY LTG	20A-1	33	20A-1
	450		EX CANOPY LTG	20A-1	34	20A-1
	450		EX CANOPY LTG	20A-1	35	20A-1
	450		EX CANOPY LTG	20A-1	36	20A-1
	450		EX CANOPY LTG	20A-1	37	20A-1
	450		EX CANOPY LTG	20A-1	38	20A-1
	450		EX CANOPY LTG	20A-1	39	20A-1
	450		EX CANOPY LTG	20A-1	40	20A-1
	450		EX CANOPY LTG	20A-1	41	20A-1
	450		EX CANOPY LTG	20A-1	42	20A-1
	450		EX CANOPY LTG	20A-1	43	20A-1
	450		EX CANOPY LTG	20A-1	44	20A-1
	450		EX CANOPY LTG	20A-1	45	20A-1
	450		EX CANOPY LTG	20A-1	46	20A-1
	450		EX CANOPY LTG	20A-1	47	20A-1
	450		EX CANOPY LTG	20A-1	48	20A-1
	450		EX CANOPY LTG	20A-1	49	20A-1
	450		EX CANOPY LTG	20A-1	50	20A-1
	450		EX CANOPY LTG	20A-1	51	20A-1
	450		EX CANOPY LTG	20A-1	52	20A-1
	450		EX CANOPY LTG	20A-1	53	20A-1
	450		EX CANOPY LTG	20A-1	54	20A-1
	450		EX CANOPY LTG	20A-1	55	20A-1
	450		EX CANOPY LTG	20A-1	56	20A-1
	450		EX CANOPY LTG	20A-1	57	20A-1
	450		EX CANOPY LTG	20A-1	58	20A-1
	450		EX CANOPY LTG	20A-1	59	20A-1
	450		EX CANOPY LTG	20A-1	60	20A-1
	450		EX CANOPY LTG	20A-1	61	20A-1
	450		EX CANOPY LTG	20A-1	62	20A-1
	450		EX CANOPY LTG	20A-1	63	20A-1
	450		EX CANOPY LTG	20A-1	64	20A-1
	450		EX CANOPY LTG	20A-1	65	20A-1
	450		EX CANOPY LTG	20A-1	66	20A-1
	450		EX CANOPY LTG	20A-1	67	20A-1
	450		EX CANOPY LTG	20A-1	68	20A-1
	450		EX CANOPY LTG	20A-1	69	20A-1
	450		EX CANOPY LTG	20A-1	70	20A-1
	450		EX CANOPY LTG	20A-1	71	20A-1
	450		EX CANOPY LTG	20A-1	72	20A-1
	450		EX CANOPY LTG	20A-1	73	20A-1
	450		EX CANOPY LTG	20A-1	74	20A-1
	450		EX CANOPY LTG	20A-1	75	20A-1
	450		EX CANOPY LTG	20A-1	76	20A-1
	450		EX CANOPY LTG	20A-1	77	20A-1
	450		EX CANOPY LTG	20A-1	78	20A-1
	450		EX CANOPY LTG	20A-1	79	20A-1
	450		EX CANOPY LTG	20A-1	80	20A-1
	450		EX CANOPY LTG	20A-1	81	20A-1
	450		EX CANOPY LTG	20A-1	82	20A-1
	450		EX CANOPY LTG	20A-1	83	20A-1
	450		EX CANOPY LTG	20A-1	84	20A-1
	450		EX CANOPY LTG	20A-1	85	20A-1
	450		EX CANOPY LTG	20A-1	86	20A-1
	450		EX CANOPY LTG	20A-1	87	20A-1
	450		EX CANOPY LTG	20A-1	88	20A-1
	450		EX CANOPY LTG	20A-1	89	20A-1
	450		EX CANOPY LTG	20A-1	90	20A-1
	450		EX CANOPY LTG	20A-1	91	20A-1
	450		EX CANOPY LTG	20A-1	92	20A-1
	450		EX CANOPY LTG	20A-1	93	20A-1
	450		EX CANOPY LTG	20A-1	94	20A-1
	450		EX CANOPY LTG	20A-1	95	20A-1
	450		EX CANOPY LTG	20A-1	96	20A-1
	450		EX CANOPY LTG	20A-1	97	20A-1
	450		EX CANOPY LTG	20A-1	98	20A-1
	450		EX CANOPY LTG	20A-1	99	20A-1
	450		EX CANOPY LTG	20A-1	100	20A-1
	450		EX CANOPY LTG	20A-1	101	20A-1
	450		EX CANOPY LTG	20A-1	102	20A-1
	450		EX CANOPY LTG	20A-1	103	20A-1
	450		EX CANOPY LTG	20A-1	104	20A-1
	450		EX CANOPY LTG	20A-1	105	20A-1
	450		EX CANOPY LTG	20A-1	106	20A-1
	450		EX CANOPY LTG	20A-1	107	20A-1
	450		EX CANOPY LTG	20A-1	108	20A-1
	450		EX CANOPY LTG	20A-1	109	20A-1
	450		EX CANOPY LTG	20A-1	110	20A-1
	450		EX CANOPY LTG	20A-1	111	20A-1
	450		EX CANOPY LTG	20A-1	112	20A-1
	450		EX CANOPY LTG	20A-1	113	20A-1
	450		EX CANOPY LTG	20A-1	114	20A-1
	450		EX CANOPY LTG	20A-1	115	20A-1
	450		EX CANOPY LTG	20A-1	116	20A-1
	450		EX CANOPY LTG	20A-1	117	20A-1
	450		EX CANOPY LTG	20A-1	118	20A-1
	450		EX CANOPY LTG	20A-1	119	20A-1
	450		EX CANOPY LTG	20A-1	120	20A-1
	450		EX CANOPY LTG	20A-1	121	20A-1
	450		EX CANOPY LTG	20A-1	122	20A-1
	450		EX CANOPY LTG	20A-1	123	20A-1
	450		EX CANOPY LTG	20A-1	124	20A-1
	450		EX CANOPY LTG	20A-1	125	20A-1
	450		EX CANOPY LTG	20A-1	126	20A-1
	450		EX CANOPY LTG	20A-1	127	20A-1
	450		EX CANOPY LTG	20A-1	128	20A-1
	450		EX CANOPY LTG	20A-1	129	20A-1
	450		EX CANOPY LTG	20A-1	130	20A-1
	450		EX CANOPY LTG	20A-1	131	20A-1
	450		EX CANOPY LTG	20A-1	132	20A-1
	450		EX CANOPY LTG	20A-1	133	20A-1
	450		EX CANOPY LTG	20A-1	134	20A-1
	450		EX CANOPY LTG	20A-1	135	20A-1
	450		EX CANOPY LTG	20A-1	136	20A-1
	450		EX CANOPY LTG	20A-1	137	20A-1
	450		EX CANOPY LTG	20A-1	138	20A-1
	450		EX CANOPY LTG	20A-1	139	20A-1
	450		EX CANOPY LTG	20A-1	140	20A-1
	450		EX CANOPY LTG	20A-1	141	20A-1
	450		EX CANOPY LTG	20A-1	142	20A-1
	450		EX CANOPY LTG	20A-1	143	20A-1
	450		EX CANOPY LTG	20A-1	144	20A-1
	450		EX CANOPY LTG	20A-1	145	20A-1
	450		EX CANOPY LTG	20A-1	146	20A-1
	450		EX CANOPY LTG	20A-1	147	20A-1
	450		EX CANOPY LTG	20A-1	148	20A-1
	450		EX CANOPY LTG	20A-1	149	20A-1
	450		EX CANOPY LTG	20A-1	150	20A-1
	450		EX CANOPY LTG	20A-1	151	20A-1
	450		EX CANOPY LTG	20A-1	152	20A-1
	450		EX CANOPY LTG	20A-1	153	20A-1
	450		EX CANOPY LTG	20A-1	154	20A-1
	450		EX CANOPY LTG	20A-1	155	20A-1
	450		EX CANOPY LTG	20A-1	156	20A-1
	450		EX CANOPY LTG	20A-1	157	20A-1
	450		EX CANOPY LTG	20A-1	158	20A-1
	450		EX CANOPY LTG	20A-1	159	20A-1
	450		EX CANOPY LTG	20A-1	160	20A-1
	450		EX CANOPY LTG	20A-1	161	20A-1
	450		EX CANOPY LTG	20A-1	162	20A-1
	450		EX CANOPY LTG	20A-1	163	20A-1
	450		EX CANOPY LTG	20A-1	164	20A-1
	450		EX CANOPY LTG	20A-1	165	20A-1
	450		EX CANOPY LTG	20A-1	166	20A-1
	450		EX CANOPY LTG	20A-1	167	20A-1
	450		EX CANOPY LTG	20A-1	168	20A-1
	450		EX CANOPY LTG	20A-1	169	20A-1
	450		EX CANOPY LTG	20A-1	170	20A-1
	450		EX CANOPY LTG	20A-1	171	20A-1
	450		EX CANOPY LTG	20A-1	172	20A-1
	450		EX CANOPY LTG	20A-1	173	20A-1
	450		EX CANOPY LTG	20A-1	174	20A-1
	450		EX CANOPY LTG	20A-1	175	20A-1
	450		EX CANOPY LTG	20A-1	176	20A-1
	450		EX CANOPY LTG	20A-1	177	

STATE PROJECT NUMBER
1000-57-70

ELEVATOR SCHEDULE													
ELEVATOR NO	CATEGORY	TYPE	AL7.1 CAPACITY (LBS.)	APTA CAPACITY (LBS.)	RATED SPEED (FPM)	PIT DEPTH	CLEAR OVERHEAD	CLEAR HOISTWAY WIDTH	CLEAR HOISTWAY DEPTH	PLATFORM WIDTH	PLATFORM DEPTH	CAR INSIDE WIDTH	CAR INSIDE DEPTH
ELEV. 01, 02, 03, 04	PASSENGER CLASS A	OVERHEAD TRACTION	4,000	6,000	200	5'-8"	17'-30"	9'-4"	7'-11"	8'-0"	6'-2"	7'-9"	5'-4 1/2"
ELEVATOR SCHEDULE (CONTINUED)													
		DOOR											
ELEVATOR NO	DOOR WIDTH	DOOR HEIGHT	TYPE	CAR TYPE	TRAVEL	NUMBER OF STOPS	NUMBER OF OPENINGS	LEVELS SERVED	POWER (HP)	STARTING CURRENT 480V, 3PH, 60Hz (A)	RUNNING CURRENT 480V, 3PH, 60Hz (A)	NET RELEASE AT CONTROL ROOM (BTU/HR/UNIT)	
ELEV. 01, 02, 03, 04	4'-0"	7'-0"	SINGLE SPEED SIDE OPENING	FRONT OPENING	24'-10 3/8"	2	2 (2F / 0R)	PLATFORM & OVERPASS	30	80	40	21,000	

Addendum No. 03
ID 1000-57-70
Revised Sheet 284
December 7, 2022

1	12/7/22	ELEVATOR SPEED REVISION	LD
		REVISION	BY
STATE OF WISCONSIN DEPARTMENT OF TRANSPORTATION			
VERTICAL TRANSPORTATION			
		DRAWN	LD
		CHECKED	SY
ELEV. 01-04, SCHEDULE			284

SCALE = AS NOTED



Proposal Schedule of Items

Proposal ID: 20221213016 Project(s): 1000-57-70

Federal ID(s): FR-CRS-0068-2

SECTION: 0001

Contract Items

Alt Set ID:

Alt Mbr ID:

Proposal Line Number	Item ID Description	Approximate Quantity and Units	Unit Price	Bid Amount
0246	SPV.0060 Special 18. Lighting	1.000 EACH	_____.	_____.
0248	SPV.0060 Special 19. General Electrical Work	1.000 EACH	_____.	_____.
0250	SPV.0060 Special 20. Fire Alarm System	1.000 EACH	_____.	_____.
0252	SPV.0060 Special 21. Lightning Protection For Structures	1.000 EACH	_____.	_____.
0254	SPV.0060 Special 22. Plumbing Work	1.000 EACH	_____.	_____.
0256	SPV.0060 Special 23. Stairs	1.000 EACH	_____.	_____.
0258	SPV.0060 Special 24. Rough Carpentry	1.000 EACH	_____.	_____.
0260	SPV.0060 Special 25. Metal Fabrications	1.000 EACH	_____.	_____.
0262	SPV.0060 Special 26. Gypsum Board Partitions And Assemblies	1.000 EACH	_____.	_____.
0264	SPV.0060 Special 27. Ceilings	1.000 EACH	_____.	_____.
0266	SPV.0060 Special 28. Interior And Exterior Signage	1.000 EACH	_____.	_____.
0268	SPV.0060 Special 29. Other Architectural Work	1.000 EACH	_____.	_____.
0270	SPV.0060 Special 30. Fire Suppression	1.000 EACH	_____.	_____.
0272	SPV.0060 Special 31. Pids, Communications, And Security Work	1.000 EACH	_____.	_____.
0274	SPV.0060 Special 32. Wheelchair Lift Enclosure, New and Relocations	1.000 EACH	_____.	_____.
0276	SPV.0085 Special 01. Structural Steel	373,374.000 LB	_____.	_____.



Wisconsin Department of Transportation

**Division of Transportation Systems
Development**

Bureau of Project Development
4822 Madison Yards Way, 4th Floor South
Madison, WI 53705

Telephone: (608) 266-1631
Facsimile (FAX): (608) 266-8459

December 9, 2022

NOTICE TO ALL CONTRACTORS:

**Proposal #16: 1000-57-70, FR-CRS-0068-2
Milwaukee Airport 2nd Platform
RR Crossing 393023R To 1200ft South
STH 119
Milwaukee County**

Letting of December 13, 2022

This is Addendum No. 04, which provides for the following:

Plan Sheets:

Revised Plan Sheets	
Plan Sheet	Plan Sheet Title (brief description of changes to sheet)
101	G-001 Code Summary & General Notes (Updated note for steel fire protection)

The responsibility for notifying potential subcontractors and suppliers of these changes remains with the prime contractor.

Sincerely,

Mike Coleman

Proposal Development Specialist
Proposal Management Section

END OF ADDENDUM

CODE SUMMARY AND GENERAL NOTES

A. STATE: WISCONSIN MUNICIPALITY: MILWAUKEE
 ADDRESS: 5601 S. 6TH STREET MILWAUKEE, WI
 THIS IS A REVISION OR INFORMATION ONLY AND SHALL NOT BE USED FOR IDENTIFICATION PURPOSES. ANY IDENTIFICATION AND COMPLY WITH ALL APPLICABLE CODES. REFER TO CHAPTER 34 (EXISTING STRUCTURES) OF THE IBC WHERE APPLICABLE.
 2015 INTERNATIONAL BUILDING CODE*
 WISCONSIN ADMINISTRATIVE CODE
 PLUMBING CODE
 CAPTERS SPS 360 THROUGH SPS 587
 MECHANICAL CODE
 2015 INTERNATIONAL MECHANICAL CODE*
 ELECTRICAL CODE
 2017 NATIONAL ELECTRICAL CODE*
 FUEL GAS CODE
 2015 NATIONAL FUEL GAS CODE*
 FIRE CODE
 2015 NATIONAL FIRE CODE*
 ACCESSIBILITY CODE
 TRANSPORTATION ACCESSIBILITY STANDARDS
 2015 INTERNATIONAL ENERGY CONSERVATION CODE (IECC)*
 PLATFORM EGRESS
 2020 EDITION NFPA 130
 *AS MODIFIED BY WISCONSIN ADMINISTRATIVE CODE.

CODE ABBREVIATIONS:
 ANSI - AMERICAN NATIONAL STANDARDS INSTITUTE
 ASCE - AMERICAN SOCIETY OF CIVIL ENGINEERS
 ASME - AMERICAN SOCIETY OF MECHANICAL ENGINEERS
 CABO - COUNCIL OF AMERICAN BUILDING OFFICIALS
 DOTAS - DEPARTMENT OF TRANSPORTATION ACCESSIBILITY STANDARDS
 IBC - INTERNATIONAL BUILDING CODE
 IFCC - INTERNATIONAL FUEL GAS CODE
 IFC - INTERNATIONAL FIRE CODE
 IMC - INTERNATIONAL MECHANICAL CODE
 IPC - INTERNATIONAL PLUMBING CODE
 IRC - INTERNATIONAL RESIDENTIAL CODE
 UPC - UNIFORM PLUMBING CODE

B. CODE SUMMARY - STATION BUILDING
 EXISTING BUILDING CONSTRUCTION TYPE: VB (NO CHANGE TO USE, OCCUPANCY OR EGRESS) BASED ON EXISTING DRAWINGS:
 GROUP A-3
 OCCUPANCY CLASSIFICATION, SECTION 303.4 ASSEMBLY (WAITING AREAS IN TRANSPORTATION TERMINALS)
 GROSS WAITING AREA (INCLUDES WAITING AREA CONCOURSE AND CORRIDOR) = 9,182 SF
 NUMBER OF OCCUPANTS:
 WAITING AREA CONCOURSE (NET) = 6427 / 15 SF PP = 428
 FIXED SEATING = 292 LF / 1.5 FT/PERSON = 195
 OCCUPANTS
 TOTAL NO. OF OCCUPANTS = 624

C. PLUMBING FIXTURE COUNTS (CODE AND DESIGNATION) PER TABLE 2902.1
 AUTOMATIC SPRINKLER SYSTEMS: NO
 FIRE ALARM SYSTEMS: YES
 PARKING SPACE ANALYSIS PER TABLE 1106.1 NOT REQUIRED

D. EGRESS REQUIREMENTS FOR PLATFORM:
 1. THE MAXIMUM TRAVEL DISTANCE ON THE PLATFORM TO A POINT AT WHICH A MEANS OF EGRESS ROUTE LEAVES THE PLATFORM SHALL NOT EXCEED 325'. PROPOSED MAXIMUM = 293'.
 2. A COMMON PATH OF TRAVEL FROM THE ENDS OF THE PLATFORM SHALL NOT EXCEED 82' OR ONE CAR LENGTH, 10'-0" AT BOTH ENDS OR PROPOSED COMMON PATH = 80'-0".
 3. AT LEAST TWO MEANS OF EGRESS REMOTE FROM EACH OTHER SHALL BE PROVIDED FROM EACH STATION PLATFORM. THREE MEANS OF EGRESS PROPOSED - TWO RAMP AT EACH END OF PLATFORM AND ONE STAR TO THE EXISTING BRIDGE.
 4. MEANS OF EGRESS SHALL BE PROVIDED ALONG ALL PLATFORMS, CORRIDORS, AND RAMP SERVING AS A MEANS OF EGRESS. PROPOSED RAMP WIDTH = 8'-0" (6'-4" 1/2" CLEAR)
 5. STAIRS IN THE MEANS OF EGRESS SHALL BE A MINIMUM OF 44" WIDE. PROPOSED STAIR WIDTH = 6'-2 1/2" CLEAR

E. TOLERANCE NOTES:
 NOTES ON THE ACCESSIBLE STATIONS DEVELOPMENT PROGRAM:
 1. IT IS THE EXPRESS PURPOSE OF ALL WORK UNDER THIS CONTRACT TO BRING THE STATION INTO COMPLIANCE

WITH THE 2008 DEPARTMENT OF TRANSPORTATION ACCESSIBILITY STANDARDS (DOTAS)
 2. IT SHALL BE THE DUTY OF THE CONTRACTOR TO PREPARE THE DESIGN FIELD CONDITIONS OF ANY CONDITION WHERE IT IS NOT POSSIBLE TO COMPLY WITH THE DESIGN FIELD CONDITIONS
 3. ALL WORK THAT FAILS TO COMPLY WITH THE DESIGN INTENT GIVEN IN THE CONTRACT DOCUMENTS SHALL BE REPLACED AT NO ADDITIONAL COST BY THE CONTRACTOR.

F. DIMENSIONING NOTES:
 1. DIMENSIONS INDICATED AS "HOLD" ARE CRITICAL FOR COMPLIANCE AND MAY NOT BE REDUCED OR ENLARGED.
 2. DIMENSIONS INDICATED AS "MIN" ARE CRITICAL FOR DOTAS COMPLIANCE AND MAY NOT BE REDUCED.
 3. DIMENSIONS INDICATED AS "MAX" ARE CRITICAL FOR DOTAS COMPLIANCE AND MAY NOT BE ENLARGED OR REDUCED.
 4. ANY DEVIATION FROM ITEMS 1 THROUGH 3 ABOVE MUST BE APPROVED PRIOR TO CONSTRUCTION.

G. TYPICAL GRADING NOTES:
 1. IT SHALL BE THE CONTRACTOR'S RESPONSIBILITY TO VERIFY ALL FINISHED GRADES THAT COMPLY WITH THE CONSTRUCTION TOLERANCES LISTED IN THIS SECTION.
 2. THE CONTRACTOR SHALL USE THE FOLLOWING CRITERIA AT ALL NEW PAVED AREAS.
 3. WALKWAYS:
 a. MAXIMUM RUNNING SLOPE SHALL NOT EXCEED 1:22 (4.5%)
 b. MAXIMUM CROSS SLOPE SHALL NOT EXCEED 1:60 (1.67%)
 4. RAMPS, STAIRS, AND LANDINGS:
 a. MAXIMUM SLOPE AT STAIR TREADS AND LANDINGS SHALL NOT EXCEED 1:60 (1.67%) IN ANY DIRECTION.
 b. EXCEED 1:13 (7.69%)
 c. MAXIMUM CROSS SLOPE AT RAMPS SHALL NOT EXCEED 1:60 (1.67%)
 5. MAXIMUM SLOPE AT ADA PARKING STALLS SHALL NOT EXCEED 1:60 (1.67%) IN ANY DIRECTION.
 6. CONTACT SURF SHALL ADJUST DIMENSIONS AS REQUIRED IN ORDER TO MAINTAIN THE PROPOSED FINISH GRADES BETWEEN NEW AND EXISTING PAVEMENTS OR SIDEWALKS SHALL BE FULL THICKNESS AND SET FLUSH WITH EXISTING PAVEMENT OR SIDEWALKS AND MEET THE ABOVE CRITERIA.
 7. THESE TOLERANCES CANNOT BE ACHIEVED DUE TO EXISTING CONDITIONS DISCREPANCIES. CONTRACTOR SHALL NOTIFY PROJECT ENGINEER IMMEDIATELY.

H. GENERAL NOTES:
 1. DRAWINGS ARE NOT TO BE SCALED. USE DIMENSIONS ONLY. ALL DIMENSIONS AND CONDITIONS SHOWN AND AS NOTED ON THE DRAWINGS SHALL BE MAINTAINED AT THE SITE BY THE CONTRACTOR BEFORE BEGINNING ANY MATERIAL OR DOING ANY WORK. ANY DISCREPANCIES IN THE DRAWINGS AND SPECIFICATIONS SHALL BE REPORTED TO THE AUTHORITY. NO CHANGE IN DRAWINGS OR SPECIFICATIONS IS PERMISSIBLE WITHOUT THE WRITTEN CONSENT OF THE ARCHITECT/ENGINEER. NO WORK SHALL BE PERFORMED UNTIL SUCH DISCREPANCY HAS BEEN RECTIFIED.
 2. ALL WORK ON THESE DRAWINGS SHALL BE CONSIDERED NEW WORK UNLESS OTHERWISE NOTED.
 3. ALL WORK MUST BE COORDINATED WITH THE AMTRAK STATION PERSONNEL SO AS NOT TO INTERFERE WITH THE OPERATION OF THE TRAINS.
 4. CONTRACTOR SHALL COORDINATE THE WORK OF ALL TRADES UNDER THIS CONTRACT.
 5. THE CONTRACTOR SHALL DISCONNECT AND/OR REMOVE EXISTING PLUMBING, ELECTRICAL FIXTURES, WIRE, CONDUITS, DUCTWORK, OR OTHER WORK WHICH MIGHT INTERFERE WITH THE WORK OF THIS CONTRACT. AFTER REMOVAL OF SUCH WORK, ALL REMOVED ITEMS SHALL BE REINSTALLED BY THE CONTRACTOR AT THE SAME LOCATION UNLESS DIRECTED OTHERWISE. FURNISH NEW MATERIALS AND HARDWARE AS REQUIRED FOR COMPLETION OF WORK.
 6. THE CONTRACTOR SHALL PATCH AND REPAIR ALL WORK DAMAGED DUE TO THIS CONTRACT. ALL NEWLY INSTALLED WORK SHALL BE PROTECTED AND MAINTAINED. ALL PAINTING WORK SHALL BE PERFORMED

TO COVER THE ENTIRE HORIZONTAL OR VERTICAL SURFACE TO THE CLOSEST CORNER IN ALL FOUR DIRECTIONS. COLOR TO MATCH EXISTING CONDITIONS.
 7. ALL EXISTING WORK SHALL BE PROTECTED BY ADEQUATE BRACING AND PROTECTING ALL WORK DURING CONSTRUCTION AGAINST DAMAGE, BREAKAGE, COLLAPSE, DISTORTIONS AND OFF ALIGNMENTS ACCORDING TO CODES AND STANDARDS OF GOOD PRACTICE.
 8. ALL WORK SHALL BE INSTALLED AT THE CONTRACTOR'S SOLE RESPONSIBILITY AND SHALL BE COMPLETE AND FINISHED INSTALLATION.
 9. WHERE MANUFACTURER'S NAMES AND PRODUCT NUMBERS ARE INDICATED ON DRAWINGS, IT SHALL BE CONSIDERED THE CONTRACTOR'S RESPONSIBILITY TO VERIFY THE PERFORMANCE STANDARDS OF SUCH ITEMS. ALL OTHER PRODUCTS MUST BE SUBMITTED TO THE ARCHITECT FOR APPROVAL BEFORE THEY SHALL BE DEEMED EQUAL.
 10. ALL WORK SHALL BE INSTALLED AT THE CONTRACTOR'S SOLE RESPONSIBILITY AND SHALL BE COMPLETE AND FINISHED INSTALLATION.
 11. PLANS, BUILDING ELEVATIONS AND SECTIONS ARE SHOWN AS NOMINAL SIZE.
 12. DIMENSIONS ON WALLS, PARTITIONS AND OTHER ITEMS EXCLUSIVE OF FINISHES.
 13. THE CONTRACTOR SHALL KEEP WORK SITE FREE FROM DEBRIS AND ACCUMULATED REFUSE AND SHALL HAVE ALL DEBRIS REMOVED FROM THE WORKING AREA. ALL DEBRIS SHALL BE LEFT BROOM CLEAN AT THE END OF EACH WORKING DAY.
 14. THE CONTRACTOR SHALL, UNLESS OTHERWISE PROVIDED OTHERWISE, BE RESPONSIBLE FOR OBTAINING ALL NECESSARY INSPECTIONS AND PERMITS. THE CONTRACTOR SHALL BE RESPONSIBLE FOR THE PROPER EXECUTION OF THE WORK.
 15. THERE WILL BE NO CHANGE IN USE, EGRESS OR CONTRACT.

16. ADDITIONAL NOTES WHICH TAKE APPLICABLE.
 17. BEAMS ON UNDERSIDE OF BRIDGE TO BE 2 HRS FIRE RESISTANT. MATERIAL UL DESIGN NUMBER # D902 OR APPROVE EQUAL.

ENERGY CODE ENVELOPE REQUIREMENTS: (2015 IECC)

1. ALL ENVELOPE COMPONENTS SHALL COMPLY WITH TABLE C402.1.2 CLIMATE ZONE 6 REQUIREMENTS:
2. WALLS: MIN RT-5 CONTINUOUS INSULATION + R18 BETWEEN METAL STUDS
3. CURTAIN GLASS REQUIREMENT: U86; SHGC SEW 0.64; N 0.64
4. ALL FLAT ROOF INSULATION ABOVE METAL DECK: R30 CI
5. SLOPED ROOF AREAS CEILING WITH ATTIC: R49
6. UNINSULATED ROOF

REQUIRED SPECIAL INSPECTIONS AND TESTS IBC 2015

- SPECIAL CASES IT05.1.1
- STEEL CONSTRUCTION IT05.2
- CONCRETE CONSTRUCTION IT05.3
- MASONRY CONSTRUCTION IT05.4
- SOILS IT05.6
- DRIVEN DEEP FOUNDATIONS IT05.7
- CAST-IN-PLACE DEEP FOUNDATIONS IT05.8
- HELICAL PILE FOUNDATIONS IT05.9
- FABRICATED ITEMS IT05.10
- STRUCTURAL STEEL IT05.12.1
- SPRAYED FIRE-RESISTANCE MATERIALS IT05.14
- MASTIC AND INTUMESCENT FIRE RESISTANT COATINGS IT05.15
- FIRE RESISTANT JOINTS IT05.17
- TESTING FOR SMOKE CONTROL IT05.18
- WIND RESISTANCE
- COLD-FORMED STEEL LIGHT-FRAME CONSTRUCTION IT05.11.2
- WIND-RESISTING COMPONENTS IT05.11.3

Addendum No. 04
 ID 1000-57-70
 Revised Sheet 101
 December 9, 2022

NO.	DATE	REVISION	BY
STATE OF WISCONSIN DEPARTMENT OF TRANSPORTATION			
ARCHITECTURAL			
DESIGNED BY	JR	PLANS CHECKED	DK
CODE SUMMARY & GENERAL NOTES			
SHEET			G-001
101			