

HIGHWAY WORK PROPOSAL

Wisconsin Department of Transportation
DT1502 01/2020 s.66.0901(7) Wis. Stats

Proposal Number: **001**

<u>COUNTY</u>	<u>STATE PROJECT</u>	<u>FEDERAL</u>	<u>PROJECT DESCRIPTION</u>	<u>HIGHWAY</u>
Dane	1009-11-78	N/A	Madison - Portage; River Road Bridge B-13-89	IH 039

ADDENDUM REQUIRED ATTACHED AT BACK

This proposal, submitted by the undersigned bidder to the Wisconsin Department of Transportation, is in accordance with the advertised request for proposals. The bidder is to furnish and deliver all materials, and to perform all work for the improvement of the designated project in the time specified, in accordance with the appended Proposal Requirements and Conditions.

Proposal Guaranty Required: \$20,000.00 Payable to: Wisconsin Department of Transportation	Attach Proposal Guaranty on back of this PAGE.
Bid Submittal Date: March 14, 2023 Time (Local Time): 11:00 am	Firm Name, Address, City, State, Zip Code
Contract Completion Time 30 Working Days	SAMPLE NOT FOR BIDDING PURPOSES
Assigned Disadvantaged Business Enterprise Goal 0%	This contract is exempt from federal oversight.

This certifies that the undersigned bidder, duly sworn, is an authorized representative of the firm named above; that the bidder has examined and carefully prepared the bid from the plans, Highway Work Proposal, and all addenda, and has checked the same in detail before submitting this proposal or bid; and that the bidder or agents, officer, or employees have not, either directly or indirectly, entered into any agreement, participated in any collusion, or otherwise taken any action in restraint of free competitive bidding in connection with this proposal bid.

Do not sign, notarize, or submit this Highway Work Proposal when submitting an electronic bid on the Internet.

Subscribed and sworn to before me this date _____

(Signature, Notary Public, State of Wisconsin)

(Bidder Signature)

(Print or Type Name, Notary Public, State Wisconsin)

(Print or Type Bidder Name)

(Date Commission Expires)

(Bidder Title)

Notary Seal

Type of Work: Bridge Repair, Pavement Marking.	For Department Use Only
Notice of Award Dated	Date Guaranty Returned

**PLEASE ATTACH
PROPOSAL GUARANTY HERE**

PROPOSAL REQUIREMENTS AND CONDITIONS

The bidder, signing and submitting this proposal, agrees and declares as a condition thereof, to be bound by the following conditions and requirements.

If the bidder has a corporate relationship with the proposal design engineering company, the bidder declares that it did not obtain any facts, data, or other information related to this proposal from the design engineering company that was not available to all bidders.

The bidder declares that they have carefully examined the site of, and the proposal, plans, specifications and contract forms for the work contemplated, and it is assumed that the bidder has investigated and is satisfied as to the conditions to be encountered, as to the character, quality, and quantities of work to be performed and materials to be furnished, and as to the requirements of the specifications, special provisions and contract. It is mutually agreed that submission of a proposal shall be considered conclusive evidence that the bidder has made such examination.

The bidder submits herewith a proposal guaranty in proper form and amount payable to the party as designated in the advertisement inviting proposals, to be retained by and become the property of the owner of the work in the event the undersigned shall fail to execute the contract and contract bond and return the same to the office of the engineer within fourteen (14) days after having been notified in writing to do so; otherwise to be returned.

The bidder declares that they understand that the estimate of quantities in the attached schedule is approximate only and that the attached quantities may be greater or less in accordance with the specifications.

The bidder agrees to perform the said work, for and in consideration of the payment of the amount becoming due on account of work performed, according to the unit prices bid in the following schedule, and to accept such amounts in full payment of said work.

The bidder declares that all of the said work will be performed at their own proper cost and expense, that they will furnish all necessary materials, labor, tools, machinery, apparatus, and other means of construction in the manner provided in the applicable specifications and the approved plans for the work together with all standard and special designs that may be designed on such plans, and the special provisions in the contract of which this proposal will become a part, if and when accepted. The bidder further agrees that the applicable specifications and all plans and working drawings are made a part hereof, as fully and completely as if attached hereto.

The bidder, if awarded the contract, agrees to begin the work not later than ten (10) days after the date of written notification from the engineer to do so, unless otherwise stipulated in the special provisions.

The bidder declares that if they are awarded the contract, they will execute the contract agreement and begin and complete the work within the time named herein, and they will file a good and sufficient surety bond for the amount of the contract for performance and also for the full amount of the contract for payment.

The bidder, if awarded the contract, shall pay all claims as required by Section 779.14, Statutes of Wisconsin, and shall be subject to and discharge all liabilities for injuries pursuant to Chapter 102 of the Statutes of Wisconsin, and all acts amendatory thereto. They shall further be responsible for any damages to property or injury to persons occurring through their own negligence or that of their employees or agents, incident to the performance of work under this contract, pursuant to the Standard Specifications for Road and Bridge Construction applicable to this contract.

In connection with the performance of work under this contract, the contractor agrees to comply with all applicable state and federal statutes relating to non-discrimination in employment. No otherwise qualified person shall be excluded from employment or otherwise be subject to discrimination in employment in any manner on the basis of age, race, religion, color, gender, national origin or ancestry, disability, arrest or conviction record (in keeping with s. 111.32), sexual orientation, marital status, membership in the military reserve, honesty testing, genetic testing, and outside use of lawful products. This provision shall include, but not be limited to the following: employment, upgrading, demotion or transfer; recruitment or recruitment advertising; layoff or termination; rates of pay or other forms of compensation, and selection for training, including apprenticeship. The contractor further agrees to ensure equal opportunity in employment to all applicants and employees and to take affirmative action to attain a representative workforce.

The contractor agrees to post notices and posters setting forth the provisions of the nondiscrimination clause, in a conspicuous and easily accessible place, available for employees and applicants for employment.

If a state public official (section 19.42, Stats.) or an organization in which a state public official holds at least a 10% interest is a party to this agreement, this contract is voidable by the state unless appropriate disclosure is made to the State of Wisconsin Ethics Board.

BID PREPARATION

Preparing the Proposal Schedule of Items

A. General

- (1) Obtain bidding proposals as specified in section 102 of the standard specifications prior to 11:45 AM of the last business day preceding the letting. Submit bidding proposals using one of the following methods:
 1. Electronic bid on the internet.
 2. Electronic bid on a printout with accompanying diskette or CD ROM.
 3. Paper bid under a waiver of the electronic submittal requirements.
- (2) Bids submitted on a printout with accompanying diskette or CD ROM or paper bids submitted under a waiver of the electronic submittal requirements govern over bids submitted on the internet.
- (3) The department will provide bidding information through the department's web site at:

<https://wisconsin.gov/Pages/doing-bus/contractors/hcci/bid-let.aspx>

The contractor is responsible for reviewing this web site for general notices as well as information regarding proposals in each letting. The department will also post special notices of all addenda to each proposal through this web site no later than 4:00 PM local time on the Thursday before the letting. Check the department's web site after 5:00 PM local time on the Thursday before the letting to ensure all addenda have been accounted for before preparing the bid. When bidding using methods 1 and 2 above, check the Bid Express™ on-line bidding exchange at <http://www.bidx.com/> after 5:00 PM local time on the Thursday before the letting to ensure that the latest schedule of items Expedite file (*.ebs or *.00x) is used to submit the final bid.

- (4) Interested parties can subscribe to the Bid Express™ on-line bidding exchange by following the instructions provided at the www.bidx.com web site or by contacting:

Info Tech Inc.
5700 SW 34th Street, Suite 1235
Gainesville, FL 32608-5371
email: <mailto:customer.support@bidx.com>

- (5) The department will address equipment and process failures, if the bidder can demonstrate that those failures were beyond their control.
- (6) Contractors are responsible for checking on the issuance of addenda and for obtaining the addenda. Notice of issuance of addenda is posted on the department's web site at:

<https://wisconsin.gov/Pages/doing-bus/contractors/hcci/bid-let.aspx>

or by calling the department at (608) 266-1631. Addenda can ONLY be obtained from the department's web site listed above or by picking up the addenda at the Bureau of Highway Construction, 4th floor, 4822 Madison Yards Way, Madison, WI, during regular business hours.

- (7) Addenda posted after 5:00 PM on the Thursday before the letting will be emailed to the eligible bidders for that proposal. All eligible bidders shall acknowledge receipt of the addenda whether they are bidding on the proposal or not. Not acknowledging receipt may jeopardize the awarding of the project.

B. Submitting Electronic Bids

B.1 On the Internet

- (1) Do the following before submitting the bid:
 4. Have a properly executed annual bid bond on file with the department.
 5. Have a digital ID on file with and enabled by Info Tech Inc. Using this digital ID will constitute the bidder's signature for proper execution of the bidding proposal.
- (2) In lieu of preparing, delivering, and submitting the proposal as specified in 102.6 and 102.9 of the standard specifications, submit the proposal on the internet as follows:
 1. Download the latest schedule of items reflecting all addenda from the Bid Express™ web site.
 2. Use Expedite™ software to enter a unit price for every item in the schedule of items.
 3. Submit the bid according to the requirements of Expedite™ software and the Bid Express™ web site. Do not submit a bid on a printout with accompanying diskette or CD ROM or a paper bid. If the bidder does submit a bid on a printout with accompanying diskette or a paper bid in addition to the internet submittal, the department will disregard the internet bid.
 4. Submit the bid before the hour and date the Notice to Contractors designates.
 5. Do not sign, notarize, and return the bidding proposal described in 102.2 of the standard specifications.
- (3) The department will not consider the bid accepted until the hour and date the Notice to Contractors designates.

B.2 On a Printout with Accompanying Diskette or CD ROM

- (1) Download the latest schedule of items from the Wisconsin pages of the Bid Express web site reflecting the latest addenda posted on the department's web site at:
<https://wisconsin.gov/Pages/doing-bus/contractors/hcci/bid-let.aspx>
 Use Expedite™ software to prepare and print the schedule of items. Provide a valid amount for all price fields. Follow instructions and review the help screens provided on the Bid Express™ web site to assure that the schedule of items is prepared properly.

- (2) Staple an 8 1/2 by 11 inch printout of the Expedite™ generated schedule of items to the other proposal documents submitted to the department as a part of the bidder's sealed bid. As a separate submittal, not in the sealed bid envelope but due at the same time and place as the sealed bid, also provide the Expedite™ generated schedule of items on a 3 1/2 inch computer diskette or CD ROM. Label each diskette or CD ROM with the bidder's name, the 4 character department-assigned bidder identification code from the top of the bidding proposal, and a list of the proposal numbers included on that diskette or CD ROM as indicated in the following example:

Bidder Name

BN00

Proposals: 1, 12, 14, & 22

- (3) If bidding on more than one proposal in the letting, the bidder may include all proposals for that letting on one diskette or CD ROM. Include only submitted proposals with no incomplete or other files on the diskette or CD ROM.
- (4) The bidder-submitted printout of the Expedite™ generated schedule of items is the governing contract document and must conform to the requirements of section 102 of the standard specifications. If a printout needs to be altered, cross out the printed information with ink or typewriter and enter the new information and initial it in ink. If there is a discrepancy between the printout and the diskette or CD ROM, the department will analyze the bid using the printout information.

- (5) In addition to the reasons specified in section 102 of the standard specifications, proposals are irregular and the department may reject them for one or more of the following:
1. The check code printed on the bottom of the printout of the Expedite™ generated schedule of items is not the same on each page.
 2. The check code printed on the printout of the Expedite™ generated schedule of items is not the same as the check code for that proposal provided on the diskette or CD ROM.
 3. The diskette or CD ROM is not submitted at the time and place the department designates.

B Waiver of Electronic Submittal

- (1) The bidder may request a waiver of the electronic submittal requirements. Submit a written request for a waiver in lieu of bids submitted on the internet or on a printout with accompanying diskette or CD ROM. Use the waiver that was included with the paper bid document sent to the bidder or type up a waiver on the bidder's letterhead. The department will waive the electronic submittal requirements for a bidding entity (individual, partnership, joint venture, corporation, or limited liability company) for up to 4 individual proposals in a calendar year. The department may allow additional waivers for equipment malfunctions.
- (2) Submit a schedule of items on paper conforming to section 102 of the standard specifications. The department charges the bidder a \$75 administrative fee per proposal, payable at the time and place the department designates for receiving bids, to cover the costs of data entry. The department will accept a check or money order payable to: "Wisconsin, Dept. of Transportation."
- (3) In addition to the reasons specified in section 102 of the standard specifications, proposals are irregular and the department may reject them for one or more of the following:
 1. The bidder fails to provide the written request for waiver of the electronic submittal requirements.
 2. The bidder fails to pay the \$75 administrative fee before the time the department designates for the opening of bids unless the bidder requests on the waiver that they be billed for the \$75.
 3. The bidder exceeds 4 waivers of electronic submittal requirements within a calendar year.
- (4) In addition to the reasons specified in section 102 of the standard specifications, the department may refuse to issue bidding proposals for future contracts to a bidding entity that owes the department administrative fees for a waiver of electronic submittal requirements.

PROPOSAL BID BOND

DT1303 1/2006

Wisconsin Department of Transportation

Proposal Number	Project Number	Letting Date
Name of Principal		
Name of Surety	State in Which Surety is Organized	

We, the above-named Principal and the above-named Surety, are held and firmly bound unto the State of Wisconsin in the sum equal to the Proposal Guaranty for the total bid submitted for the payment to be made; we jointly and severally bind ourselves, our heirs, executors, administrators, successors and assigns. The condition of this obligation is that the Principal has submitted a bid proposal to the State of Wisconsin acting through the Department of Transportation for the improvement designated by the Proposal Number and Letting Date indicated above.

If the Principal is awarded the contract and, within the time and manner required by law after the prescribed forms are presented for signature, enters into a written contract in accordance with the bid, and files the bond with the Department of Transportation to guarantee faithful performance and payment for labor and materials, as required by law, or if the Department of Transportation shall reject all bids for the work described, then this obligation shall be null and void; otherwise, it shall be and remain in full force and effect. In the event of failure of the Principal to enter into the contract or give the specified bond, the Principal shall pay to the Department of Transportation **within 10 business days of demand** a total equal to the Proposal Guaranty as liquidated damages; the liability of the Surety continues for the full amount of the obligation as stated until the obligation is paid in full.

The Surety, for value received, agrees that the obligations of it and its bond shall not be impaired or affected by any extension of time within which the Department of Transportation may accept the bid; and the Surety does waive notice of any such extension.

IN WITNESS, the Principal and Surety have agreed and have signed by their proper officers and have caused their corporate seals to be affixed this date: **(DATE MUST BE ENTERED)**

PRINCIPAL

(Company Name) **(Affix Corporate Seal)**

(Signature and Title)

(Company Name)

(Signature and Title)

(Company Name)

(Signature and Title)

(Company Name)

(Signature and Title)

(Name of Surety) **(Affix Seal)**

(Signature of Attorney-in-Fact)

NOTARY FOR PRINCIPAL

NOTARY FOR SURETY

(Date)

(Date)

State of Wisconsin)
) ss.
_____ County)

State of Wisconsin)
) ss.
_____ County)

On the above date, this instrument was acknowledged before me by the named person(s).

On the above date, this instrument was acknowledged before me by the named person(s).

(Signature, Notary Public, State of Wisconsin)

(Signature, Notary Public, State of Wisconsin)

(Print or Type Name, Notary Public, State of Wisconsin)

(Print or Type Name, Notary Public, State of Wisconsin)

(Date Commission Expires)

(Date Commission Expires)

Notary Seal

Notary Seal

IMPORTANT: A certified copy of Power of Attorney of the signatory agent must be attached to the bid bond.

CERTIFICATE OF ANNUAL BID BOND

DT1305 8/2003

Wisconsin Department of Transportation

Time Period Valid (From/To)
Name of Surety
Name of Contractor
Certificate Holder Wisconsin Department of Transportation

This is to certify that an annual bid bond issued by the above-named Surety is currently on file with the Wisconsin Department of Transportation.

This certificate is issued as a matter of information and conveys no rights upon the certificate holder and does not amend, extend or alter the coverage of the annual bid bond.

Cancellation: Should the above policy be cancelled before the expiration date, the issuing surety will give thirty (30) days written notice to the certificate holder indicated above.

(Signature of Authorized Contractor Representative)

(Date)

CERTIFICATION REGARDING DEBARMENT, SUSPENSION, AND OTHER RESPONSIBILITY MATTERS - PRIMARY COVERED TRANSACTIONS

Instructions for Certification

1. By signing and submitting this proposal, the prospective contractor is providing the certification set out below.
2. The inability of a person to provide the certification required below will not necessarily result in denial of participation in this covered transaction. The prospective contractor shall submit an explanation of why it cannot provide the certification set out below. The certification or explanation will be considered in connection with the department or agency's determination whether to enter into this transaction. However, failure of the prospective contractor to furnish a certification or an explanation shall disqualify such person from participation in this transaction.
3. The certification in this clause is a material representation of fact upon which reliance was placed when the department determined to enter into this transaction. If it is later determined that the contractor knowingly rendered an erroneous certification in addition to other remedies available to the Federal Government the department may terminate this transaction for cause or default.
4. The prospective contractor shall provide immediate written notice to the department to whom this proposal is submitted if at any time the prospective contractor learns that its certification was erroneous when submitted or has become erroneous by reason of changed circumstances.
5. The terms "covered transaction," "debarred," "suspended," "ineligible," "lower tier covered transaction," "participant," "person," "primary covered transaction," "principal," "proposal," and "voluntarily excluded," as used in this clause, have the meanings set out in the Definitions and Coverage sections of the rules implementing Executive Order 12549. You may contact the department to which this proposal is being submitted for assistance in obtaining a copy of those regulations.
6. The prospective contractor agrees by submitting this proposal that, should this contract be entered into, it shall not knowingly enter into any lower tier covered transaction with a person who is debarred, suspended, declared ineligible, or voluntarily excluded from participation in this covered transaction, unless authorized by the department entering into this transaction.
7. The prospective contractor further agrees by submitting this proposal that it will include the clause titled "Certification Regarding Debarment, Suspension, Ineligibility and Voluntary Exclusion-Lower Tier Covered Transaction," which is included as an addendum to PR- 1273 - "Required Contract Provisions Federal Aid Construction Contracts," without modification, in all lower tier covered transactions and in all solicitations for lower tier covered transactions.
8. The contractor may rely upon a certification of a prospective subcontractor/materials supplier that it is not debarred, suspended, ineligible, or voluntarily excluded from the covered transaction, unless it knows that the certification is erroneous. A contractor may decide the method and frequency by which it determines the eligibility of its principals. Each contractor may, but is not required to, check the Disapproval List (telephone # 608/266/1631).

9. Nothing contained in the foregoing shall be construed to require establishment of a system of records in order to render in good faith the certification required by this clause. The knowledge and information of a contractor is not required to exceed that which is normally possessed by a prudent person in the ordinary course of business dealings.
10. Except for transactions authorized under paragraph 6 of these instructions, if a contractor in a covered transaction knowingly enters into a lower tier covered transaction with a person who is suspended, debarred, ineligible or voluntarily excluded from participation in this transaction, in addition to other remedies available to the Federal Government, the department may terminate this transaction for cause or default.

Certification Regarding Debarment, Suspension, and Other Responsibility Matters - Primary Covered Transactions

1. The prospective contractor certifies to the best of its knowledge and belief, that it and its principals:
 - (a) Are not presently debarred, suspended, proposed for debarment, declared ineligible, or voluntarily excluded from covered transactions by any Federal department or agency;
 - (b) Have not within a three-year period preceding this proposal been convicted of or had a civil judgment rendered against them for commission of fraud or a criminal offense in connection with obtaining, attempting to obtain, or performing a public (Federal, State or local) transaction or contract under a public transaction; violation of Federal or State antitrust statutes or commission of embezzlement, theft, forgery, bribery, falsification or destruction of records, making false statements or receiving stolen property;
 - (c) Are not presently indicted for or otherwise criminally or civilly charged by a governmental entity (Federal, State or local) with commission of any of the offense enumerated in paragraph (1)(b) of this certification; and
 - (d) Have not within a three-year period preceding this proposal had one or more public transactions (Federal, State or local) terminated for cause or default.
2. Where the prospective contractor is unable to certify to any of the statements in this certification, such prospective contractor shall attach an explanation to this proposal.

Special Provisions

Table of Contents

Article	Description	Page #
1.	General.....	2
2.	Scope of Work.....	2
3.	Prosecution and Progress.....	2
4.	Lane Rental Fee Assessment.....	3
5.	Traffic.....	3
6.	Holiday and Special Event Work Restrictions.....	4
7.	Utilities.....	4
8.	Notice to Contractor, Verification of Asbestos Inspection, No Asbestos Found.....	5
9.	Public Convenience and Safety.....	5
10.	Nighttime Work Lighting-Stationary.....	5
11.	Concrete Masonry Bridges, Item 502.0100.....	6
12.	Basic Traffic Queue Warning System, Item 643.1205.S.....	7
13.	Remove and Salvage Concrete Barrier, Item SPV.0090.01.....	9

STSP'S Revised June 28, 2022

SPECIAL PROVISIONS

1. General.

Perform the work under this construction contract for Project 1009-11-78, Madison – Portage, River Road Bridge B-13-89, IH 39, Dane County, Wisconsin as the plans show and execute the work as specified in the State of Wisconsin, Department of Transportation, Standard Specifications for Highway and Structure Construction, 2023 Edition, as published by the department, and these special provisions.

If all or a portion of the plans and special provisions are developed in the SI metric system and the schedule of prices is developed in the US standard measure system, the department will pay for the work as bid in the US standard system.

100-005 (20220628)

2. Scope of Work.

The work under this contract shall consist of prestressed girders, reinforced concrete bridge deck, tubular bridge railing, pavement marking and all incidental items necessary to complete the work as shown on the plans and included in the proposal and contract.

104-005 (20090901)

3. Prosecution and Progress.

Begin work within 10 calendar days after the engineer issues a written notice to do so.

Provide the time frame for construction of the project within the 2023 construction season to the engineer in writing within a month after executing the contract but at least 14 calendar days before the preconstruction conference. Assure that the time frame is consistent with the contract completion time. Upon approval, the engineer will issue the notice to proceed within ten calendar days before the beginning of the approved time frame.

To revise the time frame, submit a written request to the engineer at least two weeks before the beginning of the intended time frame. The engineer will approve or deny that request based on the conditions cited in the request and its effect on the department's scheduled resources.

Begin work no later than May 9, 2023, unless otherwise approved by the engineer.

Lane closures on IH-39/90/94 for work at River Road cannot begin prior to 6:00 AM, April 25, 2023, without a written notice from the engineer.

A large concrete block on the NE end of the bridge approach to be picked up by the village of DeForest. Contact Judd Blau from the Village of DeForest at (608) 846-6751 to schedule pick up.

Northern Long-eared Bat (*Myotis septentrionalis*)

Northern long-eared bats (NLEB) have the potential to inhabit the project limits because they roost in trees, bridges and culverts. Roosts may not have been observed on this project, but conditions to support the species exist. The species and all active roosts are protected by the Federal Endangered Species Act. If an individual bat or active roost is encountered during construction operations, stop work and notify the engineer and the WisDOT Regional Environmental Coordinator (REC).

Ensure all operators, employees, and subcontractors working in areas of known or presumed bat habitat are aware of environmental commitments and avoidance and minimization measures (AMMs) to protect both bats and their habitat.

Direct temporary lighting, if used, away from wooded areas during the bat active season April 1 to October 31, both dates inclusive.

If additional construction activities beyond what was originally specified are required to complete the work, approval from the engineer, following coordination with WisDOT REC, is required prior to initiating these activities. If trees with a 3-inch or greater diameter at breast height (dbh) need to be removed, no tree clearing shall occur without prior approval from the engineer, following coordination with the WisDOT

REC. Tree removal will require consultation with the United States Fish and Wildlife Service (USFWS) and may require a bat presence/absence or visual emergency survey. Notify the engineer if tree clearing cannot be avoided to begin coordination with the WisDOT REC. The WisDOT REC will initiate consultation with the USFWS and determine if a survey is necessary.

4. Lane Rental Fee Assessment.

A General

The contract designates some lane closures to perform the work. The contractor will not incur a Lane Rental Fee Assessment for closing lanes during the allowable lane closure times. The contractor will incur a Lane Rental Fee Assessment for each lane closure outside of the allowable lane closure times. If a lane is obstructed at any time due to contractor operations, it is considered a closure. The purpose of lane rental is to enforce compliance of lane restrictions and discourage unnecessary closures.

The allowable lane closure times are shown in the Traffic article.

Submit the dates of the proposed lane, ramp, and roadway restrictions to the engineer as part of the progress schedule.

B Lane Rental Fee Assessment

The Lane Rental Fee Assessment incurred for each lane closure, each ramp closure, and each full closure of a roadway, per direction of travel, is as follows:

- \$5,000 per lane, per direction of travel, per hour broken into 15-minute increments

The Lane Rental Fee Assessment represents a portion of the cost of the interference and inconvenience to the road users for each closure. All lane, roadway, or ramp closure event increments 15 minutes and less will be assessed as a 15-minute increment.

The engineer, or designated representative, will be the sole authority in determining time period length for the Lane Rental Fee Assessment.

Lane Rental Fee Assessments will not be assessed for closures due to crashes, accidents, or emergencies not initiated by the contractor.

The department will assess Lane Rental Fee Assessment by the dollar under the administrative item Failing to Open Road to Traffic. The total dollar amount of Lane Rental Fee Assessment will be computed by multiplying the Lane Rental Assessment Rate by the number of 15-minute increments of each lane closure event as described above.

Lane Rental Fee Assessment will be in effect from the time of the Notice to Proceed until the department issues final acceptance. If interim completion time or contract time expires before the completion of specified work in the contract, additional liquidated damages will be assessed as specified in standard spec 108.11 or as specified within this contract.

stp-108-065 (20161130)

5. Traffic.

River Road bridge is currently closed to traffic and will remain closed through construction.

Construction activities shall be continuous once started. The department will not grant time extensions due to multiple mobilizations, delays in material deliveries, or labor disputes that are not industry wide.

Do not store vehicles, equipment, or materials on adjacent or intersecting streets beyond the project limits without specific approval of the engineer.

Coordinate with the Village of DeForest and Dane County prior to placement of traffic control signs to ensure that county and village signs are removed at the same time that signs for this project are placed.

“Rolling stops” will be utilized during the placement of the girders and setting falsework and forms over the interstate. The southbound on ramp at CTH V shall be closed during the “rolling stops”. Arrangements for implementing the “rolling stops” on IH-39/90/94 and for temporary lane closures on the freeway shall be through Jason Koster with the department’s SW Region office at (608) 440-1331, with the WisDOT

SW Region office of the Wisconsin State Patrol and the Dane County Sheriff's Department, at least five days prior to any stoppage.

IH-39/90/94 lanes must be open to traffic at all times except for lane closures according to the following schedule:

IH-39/90/94		
Time	Lane Closure	Day
9:00 PM – 7:00 AM	1 Single Lane Closure Southbound	Friday PM through Monday AM
7:00 PM – 7:00 AM	1 Single Lane Closure Southbound	Monday PM through Friday AM
11:00 PM – 5:00 AM	2 Lane Closure Southbound	Monday PM through Monday AM
11:00 PM – 5:00 AM	Rolling Closure Southbound	Monday PM through Friday AM

Provide the engineer with a schedule of lane and shoulder closures a minimum of two weeks prior to the start of construction for incorporation into the Wisconsin Lane Closure System.

Submit any traffic control change request to the engineer at least 72 hours prior to an actual traffic control change. A request does not constitute approval.

Wisconsin Lane Closure System Advance Notification

Provide the following advance notification to the engineer for incorporation into the Wisconsin Lane Closure System (LCS).

TABLE 108-1 CLOSURE TYPE AND REQUIRED MINIMUM ADVANCE NOTIFICATION

Closure type with height, weight, or width restrictions (available width, all lanes in one direction < 16 feet)	MINIMUM NOTIFICATION
Lane and shoulder closures	7 calendar days
Full roadway closures	7 calendar days
Ramp closures	7 calendar days
Detours	7 calendar days
Closure type without height, weight, or width restrictions (available width, all lanes in one direction ≥ 16 feet)	MINIMUM NOTIFICATION
Lane and shoulder closures	3 business days
Ramp closures	3 business days
Modifying all closure types	3 business days

Discuss LCS completion dates and provide changes in the schedule to the engineer at weekly project meetings in order to manage closures nearing their completion date.

6. Holiday and Special Event Work Restrictions.

Do not perform work on, nor haul materials of any kind along or across any portion of the highway carrying River Road or IH-39/90/94 traffic, and entirely clear the traveled way and shoulders of such portions of the highway of equipment, barricades, signs, lights, and any other material that might impede the free flow of traffic during the following holiday and special event periods:

- From noon Friday, May 26, 2023 to 6:00 AM Tuesday, May 30, 2023 for Memorial Day;
- From noon Monday, July 3, 2023 to 6:00 AM Wednesday, July 5, 2023 for Independence Day.

stp-107-005 (20210113)

7. Utilities.

This contract comes under the provision of Administrative Rule Trans 220.

stp-107-065 (20080501)

The following utility companies have facilities near or within project limits, no conflicts anticipated:

Alliant Energy – Electricity
AT&T Legacy – Communications
ATC – Electricity Transmission (138 kV)
MG&E – Gas
Spectrum – Communications
TDS Metrocom -- Communications
Village of DeForest – Water

8. Notice to Contractor, Verification of Asbestos Inspection, No Asbestos Found.

John Roelke, License Number All-119523, inspected Structure B-13-0089 for asbestos on August 7, 2014. No regulated Asbestos Containing Material (RACM) was found on this structure. A copy of the inspection report is available from Brian Taylor, (608) 245-2630.

stp-107-127 (20220628)

9. Public Convenience and Safety.

Revise standard spec 107.8(6) as follows:

Do not operate motorized construction equipment other than what is required for anticipated evening and night work on River Road and IH-39/90/94 as noted in this contract from 7:00 PM until the following 7:00 AM Monday through Thursday and 9:00 PM until the following 7:00 AM Friday through Sunday, unless prior written approval is obtained from the engineer.

stp-107-001 (20060512)

10. Nighttime Work Lighting-Stationary.

A Description

This special provision describes furnishing portable lighting as necessary to complete nighttime work. Nighttime operations consist of work specifically scheduled to occur after sunset and before sunrise.

B (Vacant)

C Construction

C.1 General

This provision shall apply when providing, maintaining, moving, and removing portable light towers and equipment-mounted lighting fixtures for nighttime stationary work operations, for the duration of nighttime work on the contract.

At least 14 days before the nighttime work, furnish a lighting plan to the engineer for review and acceptance. Address the following in the plan:

1. Layout, including location of portable lighting – lateral placement, height, and spacing. Clearly show on the layout the location of all lights necessary for every aspect of work to be done at night.
2. Specifications, brochures, and technical data of all lighting equipment to be used.
3. The details on how the luminaires will be attached.
4. Electrical power source information.
5. Details on the louvers, shields, or methods to be employed to reduce glare.
6. Lighting calculations. Provide illumination with average to minimum uniformity ratio of 5:1 or less throughout the work area.
7. Detail information on any other auxiliary equipment.

C.2 Portable Lighting

Provide portable lighting that is sturdy and free standing and does not require any guy wires, braces, or any other attachments. Furnish portable lighting capable of being moved as necessary to keep up with the construction project. Position the portable lighting and trailers to minimize the risk of being impacted by traffic on the roadway or by construction traffic or equipment. Provide lightning protection for the portable lighting. Portable lighting shall withstand up to 60 mph wind velocity.

If portable generators are used as a power source, furnish adequate power to operate all required lighting equipment without any interruption during the nighttime work. Provide wiring that is weatherproof and installed according to local, state, federal (NECA and OSHA) requirements. Equip all power sources with a ground-fault circuit interrupter to prevent electrical shock.

C.3 Light Level and Uniformity

Position (spacing and mounting height) the luminaires to provide illumination with an average to minimum uniformity ratio of 5:1 or less throughout the work area.

Illuminate the area as necessary to incorporate construction vehicles, equipment, and personnel activities.

C.4 Glare Control

Design, install, and operate all lighting supplied under these specifications to minimize or avoid glare that interferes with all traffic on the roadway or that causes annoyance or discomfort for properties adjoining the roadway. Locate, aim, and adjust the luminaires to provide the adequate level of illumination and the specified uniformity in the work area without the creation of objectionable glare.

Provide louvers, shields, or visors, as needed, to reduce any objectionable levels of glare. As a minimum, ensure the following requirements are met to avoid objectionable glare on the roadways open to traffic in either direction or for adjoining properties:

1. Aim tower-mounted luminaires, either parallel or perpendicular to the roadway, so as to minimize light aimed toward approaching traffic.
2. Aim all luminaires such that the center of beam axis is no greater than 60 degrees above vertical (straight down).

If lighting does not meet above-mentioned criteria, adjust the lighting within 24 hours.

C.5 Continuous Operation

Provide and have available sufficient fuel, spare lamps, generators, and qualified personnel to ensure that the lights will operate continuously during nighttime operation. In the event of any failure of the lighting system, discontinue the operation until the adequate level of illumination is restored. Move and remove lighting as necessary.

D (Vacant)

E Payment

Costs for furnishing a lighting plan, and for providing, maintaining, moving, and removing portable lighting, tower mounted lighting, and equipment-mounted lighting required under this special provision are incidental to the contract.

stp-643-010 (20100709)

11. Concrete Masonry Bridges, Item 502.0100

Revise standard spec 502.3.10.1.1 (2) with the following:

- (2) The engineer will allow the contractor to open bridge superstructures or other structural masonry items to construction and public traffic when the concrete attains a verified compressive strength of 3500 psi.

Delete standard spec 502.3.10.1.1 (3).

12. **Basic Traffic Queue Warning System, Item 643.1205.S.**

A Description

This special provision describes providing, repositioning, operating, maintaining, monitoring, calibrating, testing and removing a basic traffic queue warning system (QWS) capable of measuring vehicular speeds at downstream sections of a roadway, and activating the system.

B Materials

Provide Basic Traffic QWS components and software that is National Transportation Communications for ITS Protocol (NCTIP) compliant.

B.1 Portable Traffic Sensors (PTS)

Provide PTS that are nonintrusive and capable of capturing vehicle speed in mph. Integrate each sensor with a modem to communicate with the automated system manager.

B.2 Static Traffic Control Signs with Temporary Flashing Beacon Signs (FBS)

Provide static traffic control signs with temporary flashing beacon signs conforming to standard spec 658.2(2) for Traffic Signal Faces. Ensure each FBS is integrated with a modem, and other equipment (e.g., automated system manager) mounted on it, and acts as a single device for communicating with similarly integrated devices and displaying real-time traffic conditions.

B.3 Automated System Manager (ASM)

Provide an ASM that assesses current traffic data captured by the PTS and activates/deactivates the FBS based on predetermined speed thresholds.

B.4 System Communications

Ensure Basic Traffic QWS communications meet the following requirements:

1. Perform required configuration of the Basic Traffic QWS's communication system automatically during system initialization.
2. Communication between the server and any individual FBS or PTS are independent through the full range of deployed locations, and do not rely upon communications with any other FBS or PTS.
3. Incorporate an error detection/correction mechanism into the Basic Traffic QWS communication system to ensure the integrity of all traffic condition data.

B.5 System Acceptance

Submit vendor verification to the engineer and Bureau of Traffic Operations (DOTBTOWorkzone@dot.wi.gov) 14 calendar days before the pre-construction meeting that the system will adequately perform the functions specified in this special provision. Adequate verification includes past successful performance of the system, literature and references from successful use of the system by other agencies, and/or demonstration of the system.

Provide contact information for a designated representative responsible for monitoring the performance of the system and for making modifications to the operational settings as the engineer directs. Provide all testing and calibration equipment.

C Construction

C.1 General

Install and reposition Basic Traffic Queue Warning System per plan or as the engineer directs. Provide plan to the engineer and Bureau of Traffic Operations (DOTBTOWorkzone@dot.wi.gov) 14 calendar days before the pre-construction meeting.

PTS may be mounted on FBS, arrow board or other trailer devices.

Install PTS at the following locations:

1. Place first PTS within the lane closure taper.
2. Place second PTS 5,700 feet upstream of the lane closure taper or on FBS #3.
3. Place third PTS 2 miles upstream of the lane closure taper or on FBS #2.

Install FBS at the following locations, delineated by 5 drums:

1. Place first FBS (FBS #3) 5,700 feet upstream of the lane closure taper.
2. Place second FBS (FBS #2) 2 miles upstream of the lane closure taper.
3. Place third FBS (FBS #1) 3 miles upstream of the lane closure taper.

If there are more than two lanes or specified in the plans, place FBS on both sides of the roadway.

Number the devices in chronological order so they are visible from the shoulder with 6-inch white high reflective sheeting.

Provide technical personnel for all system calibration, operation, maintenance, and timely on-call support services.

Promptly correct the system within 24 hours of becoming aware of a deficiency in the operation or individual part of the system. A minimum of three days before deployment, place the Basic Traffic QWS and demonstrate to the department that the Basic Traffic QWS is operational.

Maintain the Basic Traffic QWS for the duration of the project. Ensure the system operates continuously (24 hours, 7 days a week) in the automated mode throughout the duration of the project.

Remove the system upon completion.

C.2 Reports

Provide an electronic copy of a weekly summary report of all data via email to the engineer. Ensure the report includes, at a minimum, the average speed per sensor, time in congestive state per sensor and number of triggers per day.

C.3 Meetings

Attend mandatory in-person pre-construction meetings with the department. Attend additional meetings as deemed necessary by the department. These meetings may be held in person or via teleconference, as scheduled by the department.

C.4 Programming

C.4.1 General

Program the Basic Traffic QWS to ensure that the following general operations are performed:

1. Provide a password protected login to the ASM, website and all other databases.
2. Automatic setting of the FBS to reflect current traffic flow status updated every 60 seconds for congestion. Ensure to remove a congestion message when 180 seconds of average traffic speeds above the current level are observed, or utilize a customized frequency as determined by the engineer.
3. The FBS activate based on pre-determined speed thresholds from the next downstream sensor.
 - FBS #3 shall activate based on traffic speeds at the PTS located within the lane closure taper.
 - FBS #2 shall activate based on traffic speeds at the PTS located approximately 1 mile upstream of lane closure taper, or at FBS #3.
 - FBS #1 shall activate based on traffic speeds at the PTS located 2 miles upstream of lane closure taper, or at FBS #2.
4. Provide real-time data from the ASM to a website with a full color mapping feature and refresh every 60 seconds. Make data on website available to the department staff at all times for the duration of the work zone activity. Ensure website includes:
 - Vehicle speeds
 - FBS triggers
 - Device locations
5. Archive all traffic data in a Microsoft Excel format with date and time stamps.
6. Configure the website to quantify system failures which includes communication disruption between any devices in the system configuration, FBS malfunctioning, PTS malfunction, loss of power, low battery, etc.
7. Automatically generate and send an email alert any time a user specified queue is detected by the system.
8. Ensure the system autonomously restarts in case of any power failure.

C.4.2 System Operation Strategy

Arrange for the vendor/manufacturer to coordinate system operation, detection, and trends/thresholds with the engineer.

The sequences below are a minimum requirement, but can be adjusted at the discretion of the engineer, are as follows:

Free Flow:

If the current PTS speed on a downstream section is at or above 40 mph, the next upstream FBS will not flash.

Slow or Stopped Traffic:

If the current PTS speed on a downstream section of the roadway is between the 39 mph and 0 mph (for example, 35 mph), the next upstream FBS shall flash.

C.5 Calibration and Testing

At the beginning of the project perform a successful field test and calibration at the Basic Traffic QWS location to verify the system is detecting accurate vehicle speeds, and accurately relaying the information to the ASM and the FBS.

Send email of successful calibration and testing to the engineer.

D Measurement

The department will measure Basic Traffic Queue Warning System by the day, acceptably completed, measured as each complete system per roadway.

E Payment

The department will pay for measured quantities at the contract unit price under the following bid item:

ITEM NUMBER	DESCRIPTION	UNIT
643.1205.S	Basic Traffic Queue Warning System	DAY

Payment is full compensation for providing, repositioning, operating, maintaining, monitoring, calibrating, testing, and removing the complete system consisting of FBS, PTS, ASM, and system communications.

Failure to correct a deficiency to the FBS, PTS, or ASM within 24 hours after notification from the engineer or the department will result in a one-day deduction of the measured quantity for each day in which the deficiency is not corrected.

Failure to correct the website within 24 hours after notification from the engineer will result in a 10% reduction of the day quantity for each day the website is down.

The engineer will have sole discretion to assess the deductions for an improperly working Basic Traffic QWS.

stp-643-046 (20210113)

13. Remove and Salvage Concrete Barrier, Item SPV.0090.01.

A Description

This special provision describes removing existing concrete barrier temporary precast and storing for pick up by Dane County and the village of DeForest. The temporary barrier has been left in place by Dane County and the village of DeForest. The location of this temporary barrier is shown in the plans.

B Materials

The concrete barrier left in place by Dane County and the Village of Deforest is Concrete Barrier Temporary Precast per standard spec 603.

C Construction

Remove the existing concrete barrier according to standard spec 204. Store the concrete barrier for Dane County and the Village of DeForest to pick up. Contact Jon Strandle from Dane County at (608) 575-2243 and Judd Blau from the Village of DeForest at (608) 846-6751 at least three working days prior to removal to schedule pick up.

D Measurement

The department will measure Remove and Salvage Concrete Barrier by the linear feet of removal, acceptably completed.

E Payment

The department will pay for measured quantities at the contract unit price under the following bid item:

ITEM NUMBER	DESCRIPTION	UNIT
SPV.0090.08.	Remove and Salvage Concrete Barrier	LF

Payment is full compensation for removal, moving, and storing.

ADDITIONAL SPECIAL PROVISION 4

This special provision does not limit the right of the department, prime contractor, or subcontractors at any tier to withhold payment for work not acceptably completed or work subject to an unresolved contract dispute.

Payment to First-Tier Subcontractors

Within 10 calendar days of receiving a progress payment for work completed by a subcontractor, pay the subcontractor for that work. The prime contractor may withhold payment to a subcontractor if, within 10 calendar days of receipt of that progress payment, the prime contractor provides written notification to the subcontractor and the department documenting "just cause" for withholding payment.

The prime contractor is not allowed to withhold retainage from payments due subcontractors.

Payment to Lower-Tier Subcontractors

Ensure that subcontracting agreements at all tiers provide prompt payment rights to lower-tier subcontractors that parallel those granted first-tier subcontractors in this provision.

Acceptance and Final Payment

Within 30 calendar days of receiving the semi-final estimate from the department, submit written certification that subcontractors at all tiers are paid in full for acceptably completed work.

Additional Special Provision 6
ASP 6 - Modifications to the standard specifications

Make the following revisions to the standard specifications:

416.2.4 Concrete Pavement Repair and Replacement

Replace the entire text with the following effective with the November 2022 letting:

- (1) Except as specified in 416.3.6 for inlaid rumble strips, use grade C concrete as specified in 501.
- (2) The engineer will allow the contractor to open to construction and public traffic when the concrete reaches 2000 psi.

416.2.5 Special High Early Strength Concrete Pavement Repair and Replacement

416.2.5.1 Composition and Proportioning of Concrete

Replace paragraph one with the following effective with the November 2022 letting:

- (1) For the concrete mixture, use a minimum of 846 pounds of cementitious material per cubic yard of concrete. The engineer will allow the contractor to open to construction and public traffic when the concrete reaches 2000 psi. The contractor may add one or a combination of admixtures to the ingredients or to the mixture in order to obtain the required minimum strength and required air content. Do not retemper the concrete mixture.

455.2.4.3 Emulsified Asphalts

Replace paragraph one with the following effective with the November 2022 letting:

- (1) Furnish material conforming, before dilution, to the following:
 - Anionic emulsified asphalts^[1]..... AASHTO M140
 - Cationic emulsified asphalts^[1] AASHTO M208
 - Polymer-modified cationic emulsified asphalts AASHTO M316
- ^[1] Non-tracking emulsified asphalts shall conform to TABLE 455-1 for the type and grade specified.

TABLE 455-1 Requirements for Non-Tracking Emulsified Asphalt

PRODUCT	ANTT	CNTT
Saybolt Viscosity at 77°F (25°C), (AASHTO T 59), SFS	15-100	15-100
Paddle Viscosity at 77°F (25°C), (AASHTO T 382), cPs ^[1]	30-200	30-200
Storage Stability Test, 24 hr, (AASHTO T 59), %	1 max	1 max
Residue by Distillation, 500 ± 10 °F (260 ± 5 °C), or Residue by Evaporation, 325 ± 5 °F (163 ± 3 °C), (AASHTO T 59), %	50 min	50 min
Sieve Test, No. 20 (850 µm), (AASHTO T 59), %	0.3	0.3
Penetration at 77°F (25°C), 100 g, 5 sec, (AASHTO T 49), dmm	10-40	10-40
Ash Content, (AASHTO T 111), %	1 max	1 max
Solubility in Trichlorethylene Test, (AASHTO T 44) ^[2]	97.5% min	97.5% min

^[1] Paddle Viscosity (AASHTO T 382) may be run in lieu of Saybolt Viscosity (AASHTO T 59).
^[2] The solubility in Trichlorethylene test (AASHTO T 44) may be run in lieu of Ash Content (AASHTO T 111).

455.2.5 Tack Coat

Replace paragraph one with the following effective with the November 2022 letting:

- (1) Under the Tack Coat bid item, furnish type SS-1h, CSS-1h, QS-1h, CQS-1h, ANTT, CNTT, or modified emulsified asphalt with an “h” suffix, unless the contract specifies otherwise.

710.5.7 Corrective Action

710.5.7.1 Optimized Aggregate Gradations

Replace paragraph one with the following effective with the November 2022 letting:

- (1) If the contractor's 4-point running average or a department test result of the volumetric percent retained exceeds the tarantula curve limits by less than or equal to 1.0 percent on a single sieve size, notify the other party immediately and do one of the following:
 - Perform corrective action documented in the QC plan or as the engineer approves. Continue with the following:
 1. Document and provide corrective action results to the engineer as soon as they are available.
 2. Department will conduct two tests within the next business day after corrective action is complete.
 - If blended aggregate gradations are within the tarantula curve limits by the second department test:
 - Continue with concrete production.
 - Include a break in the 4-point running average.
 - For Class I Pavements: The department will discontinue reduced frequency testing and will test at a frequency of 1 test per placement day. Once 5 consecutive samples are passing at the 1 test per placement day frequency, the reduced frequency testing will be reapplied.
 - If blended aggregate gradations are not within the tarantula curve limits by the second department test and the contract requires an optimized aggregate gradation mix under 501.2.7.4.2.1(2), stop concrete production and submit a new optimized aggregate gradation mix design.
 - If blended aggregate gradations are not within the tarantula curve limits by the second department test and the contract does not require an optimized aggregate gradation mix under 501.2.7.4.2.1(2), stop concrete production and submit either a new optimized aggregate gradation mix design or a combined aggregate gradation mix design.
 - Submit a new optimized aggregate gradation mix design and perform the following:
 1. Restart control charts for the new mix design.
 2. Amend contractor Quality Control Plan

715.5 Payment

Replace the entire text with the following effective with the November 2022 letting:

715.5.1 General

- (1) The department will pay incentive for concrete strength under the following bid items:

<u>ITEM NUMBER</u>	<u>DESCRIPTION</u>	<u>UNIT</u>
715.0502	Incentive Strength Concrete Structures	DOL
715.0603	Incentive Strength Concrete Barrier	DOL
715.0715	Incentive Flexural Strength Concrete Pavement	DOL
715.0720	Incentive Compressive Strength Concrete Pavement	DOL

- (2) Incentive payment may be more or less than the amount the schedule of items shows.
- (3) The department will administer disincentives for strength under the Disincentive Strength Concrete Structures, Disincentive Strength Concrete Barrier, Disincentive Flexural Strength Concrete Pavement, and Disincentive Compressive Strength Concrete Pavement, administrative items.
- (4) The department will adjust pay for each lot using PWL of the 28-day subplot average strengths for that lot. The department will measure PWL relative to strength lower specification limits as follows:
 - Compressive strength of 3700 psi for pavements.
 - Flexural strength of 650 psi for pavements.
 - Compressive strength of 4000 psi for structures and barrier.
- (5) The department will not pay a strength incentive for concrete that is nonconforming in another specified property, for ancillary concrete accepted based on tests of class I concrete, or for high early strength concrete unless placed in pavement gaps as allowed under 715.3.1.2.2.
- (6) Submit test results to the department electronically using MRS software. The department will verify contractor data before determining pay adjustments.
- (7) All coring and testing costs under 715.3.2.2 including filling core holes and providing traffic control during coring are incidental to the contract.

715.5.2 Pavements

715.5.2.1 Compressive

- (1) The department will adjust pay for each lot using equation “QMP 3.01” as follows:

Percent within Limits (PWL)	Pay Adjustment (dollars per square yard)
>= 95 to 100	$(0.1 \times \text{PWL}) - 9.5$
>= 85 to < 95	0
>= 30 to < 85	$(1.5/55 \times \text{PWL}) - 127.5/55$
< 30	-1.50

- (2) The department will not pay incentive if the lot standard deviation is greater than 400 psi compressive.
- (3) For lots with a full battery of QC tests at less than 4 locations, there is no incentive, but the department will assess a disincentive based on the individual subplot average strengths. The department will reduce pay for sublots with an average strength below 3700 psi compressive by \$1.50 per square yard.
- (4) For integral shoulder pavement and pavement gaps accepted using tests from the adjacent travel lane, the department will adjust pay using strength results of the travel lane for integrally placed concrete shoulders and pavement gaps regardless of mix design and placement method, included in a lane-foot lot.

715.5.2.2 Flexural

- (1) The department will adjust pay for each lot using equation “QMP 6.02” as follows:

Percent within Limits (PWL)	Pay Adjustment (dollars per square yard)
>= 95 to 100	$(0.2 \times \text{PWL}) - 19$
>= 85 to < 95	0
>= 50 to < 85	$(2.0/35 \times \text{PWL}) - 170/35$
< 50	-2.00

- (2) The department will not pay incentive if the lot standard deviation is greater than 60 psi flexural.
- (3) For lots with a full battery of QC tests at less than 4 locations, there is no incentive, but the department will assess a disincentive based on the individual subplot average strengths. The department will reduce pay for sublots with an average strength below 650 psi flexural by \$2.00 per square yard.
- (4) For integral shoulder pavement and pavement gaps accepted using tests from the adjacent travel lane, the department will adjust pay using strength results of the travel lane for integrally placed concrete shoulders and pavement gaps regardless of mix design and placement method, included in a lane-foot lot.

715.5.3 Structures and Cast-in-Place Barrier

- (1) The department will adjust pay for each lot using equation “QMP 2.01” as follows:

Percent within Limits (PWL)	Pay Adjustment (dollars per square yard)
>= 99 to 100	10
>= 90 to < 99	0
>= 50 to < 90	$(7/8 \times \text{PWL}) - 78.75$
< 50	-35

- (2) The department will not pay incentive if the lot standard deviation is greater than 350 psi.
- (3) For lots with less than 4 sublots, there is no incentive, but the department will assess a disincentive based on the individual subplot average strengths. The department will reduce pay for sublots with an average strength below 4000 psi by \$35 per cubic yard.

ADDITIONAL SPECIAL PROVISION 7

A. Reporting 1st Tier and DBE Payments During Construction

1. Comply with reporting requirements specified in the department's Civil Rights Compliance, Contractor's User Manual, Sublets and Payments.
2. Report payments to all DBE firms within 10 calendar days of receipt of a progress payment by the department or a contractor for work performed, materials furnished, or materials stockpiled by a DBE firm. Report the payment as specified in A(1) for all work satisfactorily performed and for all materials furnished or stockpiled.
3. Report payments to all first tier subcontractor relationships within 10 calendar days of receipt of a progress payment by the department for work performed. Report the payment as specified in A(1) for all work satisfactorily performed.
4. All tiers shall report payments as necessary to comply with the DBE payment requirement as specified in A(2).
5. DBE firms must enter all payments to DBE and non-DBE firms regardless of tier.
6. Require all first tier relationships, DBE firms and all other tier relationships necessary to comply with the DBE payment requirement in receipt of a progress payment by contractor to acknowledge receipt of payment as specified in A(1), (2), (3) and (4).
7. All agreements made by a contractor shall include the provisions in A(1), (2), (3), (4), (5), and (6), and shall be binding on all first tier subcontractor relationships, all contractors and subcontractors utilizing DBE firms on the project, and all payments from DBE firms.

B. Costs for conforming to this special provision are incidental to the contract.

NOTE: CRCS Prime Contractor payment is currently not automated and will need to be manually loaded into the Civil Rights Compliance System. Copies of prime contractor payments received (check or ACH) will have to be forwarded to paul.ndon@dot.wi.gov within 5 days of payment receipt to be logged manually.

***Additionally, for information on Subcontractor Sublet assignments, Subcontractor Payments and Payment Tracking, please refer to the CRCS Payment and Sublets manual at:

<https://wisconsindot.gov/Documents/doing-bus/civil-rights/labornwage/crcs-payments-sublets-manual.pdf>

ADDITIONAL SPECIAL PROVISION 9

Electronic Certified Payroll or Labor Data Submittal

- (1) Use the department's Civil Rights Compliance System (CRCS) to electronically submit certified payroll reports for contracts with federal funds and labor data for contracts with state funds only. Details are available online through the department's highway construction contractor information (HCCI) site on the Labor, Wages, and EEO Information page at:
<https://wisconsindot.gov/Pages/doing-bus/civil-rights/labornwage/default.aspx>
- (2) Ensure that all tiers of subcontractors, including all trucking firms, either submit their weekly certified payroll reports (contracts with federal funds) or labor data (contracts with state funds only) electronically through CRCS. These payrolls or labor data are due within seven calendar days following the close of the payroll period. Every firm providing physical labor towards completing the project is a subcontractor under this special provision.
- (3) Upon receipt of contract execution, promptly make all affected firms aware of the requirements under this special provision and arrange for them to receive CRCS training as they are about to begin their submittals. The department will provide training either in a classroom setting at one of our regional offices or by telephone. Contact Paul Ndon at (414) 438-4584 to schedule the training.
- (4) The department will reject all paper submittals for information required under this special provision. All costs for conforming to this special provision are incidental to the contract.
- (5) Firms wishing to export payroll/labor data from their computer system into CRCS should have their payroll coordinator contact Paul Ndon at paul.ndon@dot.wi.gov. Not every contractor's payroll system is capable of producing export files. For details, see Section 4.8 CPR Auto Submit (Data Mapping) on pages 49-50; 66-71 of the CRCS Payroll Manual at:
<https://wisconsindot.gov/Documents/doing-bus/civil-rights/labornwage/crcs-payroll-manual.pdf>

NON-DISCRIMINATION PROVISIONS

During the performance of this contract, the contractor, for itself, its assignees, and successors in interest (hereinafter referred to as the "contractor") agrees as follows:

1. Compliance with Regulations: The contractor (hereinafter includes consultants) will comply with the Acts and the Regulations relative to Non-discrimination in Federally-assisted programs of the U.S. Department of Transportation, Federal Highway Administration, as they may be amended from time to time, which are herein incorporated by reference and made a part of this contract.

2. Non-discrimination: The contractor, with regard to the work performed by it during the contract, will not discriminate on the grounds of race, color, or national origin in the selection and retention of subcontractors, including procurements of materials and leases of equipment. The contractor will not participate directly or indirectly in the discrimination prohibited by the Acts and the Regulations, including employment practices when the contract covers any activity, project, or program set forth in Appendix B of 49 CFR Part 21.

3. Solicitations for Subcontracts, Including Procurements of Materials and Equipment: In all solicitations, either by competitive bidding, or negotiation made by the contractor for work to be performed under a subcontract, including procurements of materials, or leases of equipment, each potential subcontractor or supplier will be notified by the contractor of the contractor's obligations under this contract and the Acts and the Regulations relative to Non-discrimination on the grounds of race, color, or national origin.

4. Information and Reports: The contractor will provide all information and reports required by the Acts, the Regulations, and directives issued pursuant thereto and will permit access to its books, records, accounts, other sources of information, and its facilities as may be determined by the Recipient or the Federal Highway Administration to be pertinent to ascertain compliance with such Acts, Regulations, and instructions. Where any information required of a contractor is in the exclusive possession of another who fails or refuses to furnish the information, the contractor will so certify to the Recipient or the Federal Highway Administration, as appropriate, and will set forth what efforts it has made to obtain the information.

5. Sanctions for Noncompliance: In the event of a contractor's noncompliance with the Non-discrimination provisions of this contract, the Recipient will impose such contract sanctions as it or the Federal Highway Administration may determine to be appropriate, including, but not limited to:

- a. Withholding payments to the contractor under the contract until the contractor complies; and/or
- b. Cancelling, terminating, or suspending a contract, in whole or in part.

6. Incorporation of Provisions: The contractor will include the provisions of paragraphs one through six in every subcontract, including procurements of materials and leases of equipment, unless exempt by the Acts, the Regulations and directives issued pursuant thereto. The contractor will take action with respect to any subcontract or procurement as the Recipient or the Federal Highway Administration may direct as a means of enforcing such provisions including sanctions for noncompliance. Provided, that if the contractor becomes involved in, or is threatened with litigation by a subcontractor, or supplier because of such direction, the contractor may request the Recipient to enter into any litigation to protect the interests of the Recipient. In addition, the contractor may request the United States to enter into the litigation to protect the interests of the United States.

During the performance of this contract, the contractor, for itself, its assignees, and successors in interest (hereinafter referred to as the "contractor") agrees to comply with the following non-discrimination statutes and authorities; including but not limited to:

Pertinent Non-Discrimination Authorities:

- Title VI of the Civil Rights Act of 1964 (42 U.S.C. § 2000d et seq., 78 stat. 252), (prohibits discrimination on the basis of race, color, national origin); and 49 CFR Part 21.
- The Uniform Relocation Assistance and Real Property Acquisition Policies Act of 1970, (42 U.S.C. § 4601), (prohibits unfair treatment of persons displaced or whose property has been acquired because of Federal or Federal-aid programs and projects);
- Federal-Aid Highway Act of 1973, (23 U.S.C. § 324 et seq.), (prohibits discrimination on the basis of sex);
- Section 504 of the Rehabilitation Act of 1973, (29 U.S.C. § 794 et seq.), as amended, (prohibits discrimination on the basis of disability); and 49 CFR Part 27;
- The Age Discrimination Act of 1975, as amended, (42 U.S.C. § 6101 et seq.), (prohibits discrimination on the basis of age);
- Airport and Airway Improvement Act of 1982, (49 USC § 471, Section 47123), as amended, (prohibits discrimination based on race, creed, color, national origin, or sex);
- The Civil Rights Restoration Act of 1987, (PL 100-209), (Broadened the scope, coverage and applicability of Title VI of the Civil Rights Act of 1964, The Age Discrimination Act of 1975 and Section 504 of the Rehabilitation Act of 1973, by expanding the definition of the terms "programs or activities" to include all of the programs or activities of the Federal-aid recipients, sub-recipients and contractors, whether such programs or activities are Federally funded or not);
- Titles II and III of the Americans with Disabilities Act, which prohibit discrimination on the basis of disability in the operation of public entities, public and private transportation systems, places of public accommodation, and certain testing entities (42 U.S.C. §§ 12131-12189) as implemented by Department of Transportation regulations at 49 C.F.R. parts 37 and 38;
- The Federal Aviation Administration's Non-discrimination statute (49 U.S.C. § 47123) (prohibits discrimination on the basis of race, color, national origin, and sex);
- Executive Order 12898, Federal Actions to Address Environmental Justice in Minority Populations and Low-Income Populations, which ensures Non-discrimination against minority populations by discouraging programs, policies, and activities with disproportionately high and adverse human health or environmental effects on minority and low-income populations;
- Executive Order 13166, Improving Access to Services for Persons with Limited English Proficiency, and resulting agency guidance, national origin discrimination includes discrimination because of Limited English proficiency (LEP). To ensure compliance with Title VI, you must take reasonable steps to ensure that LEP persons have meaningful access to your programs (70 Fed. Reg. at 74087 to 74100);
- Title IX of the Education Amendments of 1972, as amended, which prohibits you from discriminating because of sex in education programs or activities (20 U.S.C. 1681 et seq).

BUY AMERICA PROVISION

Buy America (as documented in M-22-11 from the Office of Management and Budget: <https://www.whitehouse.gov/wp-content/uploads/2022/04/M-22-11.pdf>) shall be domestic products and permanently incorporated in this project as classified in the following three categories, and as noted in the Construction and Materials Manual (CMM):

1. Iron and Steel

All iron and steel manufacturing and coating processes (from smelting forward in the manufacturing process) must have occurred within the United States. Coating includes epoxy coating, galvanizing, painting and any other coating that protects or enhances the value of a material subject to the requirements of Buy America.

The exemption of the iron and steel manufacturing and coating processes Buy America requirement is the minimal use of foreign materials if the total cost of such material permanently incorporated in the product does not exceed one-tenth of one percent (1/10 of 1%) of the total contract cost or \$2,500.00, whichever is greater. For purposes of this paragraph, the cost is that shown to be the value of the subject products as they are delivered to the project.

2. Manufactured Product

All manufactured products (as defined in CMM 228.5) are covered under a previous waiver from 1983, and are currently exempt from Buy America.

3. Construction Material

All construction materials (as defined in OMB M-22-11 and as referenced in CMM 228.5) must comply with Buy America. No exemptions (0.0%) are allowed.

The contractor shall take actions and provide documentation conforming to CMM 228.5 to ensure compliance with this Buy America provision.

<https://wisconsindot.gov/rdwy/cmm/cm-02-28.pdf>

Upon completion of the project, certify to the engineer, in writing using department form DT4567 that all iron and steel, manufactured products, and construction materials conform to this Buy America provision.

Form DT4567 is available at: <https://wisconsindot.gov/Documents/formdocs/dt4567.docx>

Attach a list of iron or steel exemptions and their associated costs to the certification form.



Proposal Schedule of Items

Proposal ID: 20230314001 Project(s): 1009-11-78

Federal ID(s): N/A

SECTION: 0001

Contract Items

Alt Set ID:

Alt Mbr ID:

Proposal Line Number	Item ID Description	Approximate Quantity and Units	Unit Price	Bid Amount
0002	203.0220 Removing Structure (structure) 01. B-13-89	1.000 EACH	_____.	_____.
0004	213.0100 Finishing Roadway (project) 01. 1009-11-78	1.000 EACH	_____.	_____.
0006	502.0100 Concrete Masonry Bridges	31.000 CY	_____.	_____.
0008	502.2000 Compression Joint Sealer Preformed Elastomeric (width) 01. 2-inch	15.000 LF	_____.	_____.
0010	502.3101 Expansion Device	13.000 LF	_____.	_____.
0012	502.3200 Protective Surface Treatment	99.000 SY	_____.	_____.
0014	502.3210 Pigmented Surface Sealer	23.000 SY	_____.	_____.
0016	503.0136 Prestressed Girder Type I 36-Inch	223.000 LF	_____.	_____.
0018	505.0600 Bar Steel Reinforcement HS Coated Structures	7,020.000 LB	_____.	_____.
0020	506.2610 Bearing Pads Elastomeric Laminated	3.000 EACH	_____.	_____.
0022	506.4000 Steel Diaphragms (structure) 01. B-13-89	6.000 EACH	_____.	_____.
0024	506.5000 Bearing Assemblies Fixed (structure) 01. B-13-89	3.000 EACH	_____.	_____.
0026	509.1500 Concrete Surface Repair	3.000 SF	_____.	_____.
0028	513.4051 Railing Tubular Type F	75.000 LF	_____.	_____.
0030	603.8000 Concrete Barrier Temporary Precast Delivered	128.000 LF	_____.	_____.



Proposal Schedule of Items

Proposal ID: 20230314001 Project(s): 1009-11-78

Federal ID(s): N/A

SECTION: 0001

Contract Items

Alt Set ID:

Alt Mbr ID:

Proposal Line Number	Item ID Description	Approximate Quantity and Units	Unit Price	Bid Amount
0032	603.8125 Concrete Barrier Temporary Precast Installed	128.000 LF	_____.	_____.
0034	619.1000 Mobilization	1.000 EACH	_____.	_____.
0036	642.5001 Field Office Type B	1.000 EACH	_____.	_____.
0038	643.0300 Traffic Control Drums	622.000 DAY	_____.	_____.
0040	643.0420 Traffic Control Barricades Type III	756.000 DAY	_____.	_____.
0042	643.0705 Traffic Control Warning Lights Type A	1,074.000 DAY	_____.	_____.
0044	643.0715 Traffic Control Warning Lights Type C	78.000 DAY	_____.	_____.
0046	643.0800 Traffic Control Arrow Boards	23.000 DAY	_____.	_____.
0048	643.0900 Traffic Control Signs	830.000 DAY	_____.	_____.
0050	643.1050 Traffic Control Signs PCMS	13.000 DAY	_____.	_____.
0052	643.1205.S Basic Traffic Queue Warning System	10.000 DAY	_____.	_____.
0054	643.5000 Traffic Control	1.000 EACH	_____.	_____.
0056	646.1020 Marking Line Epoxy 4-Inch	470.000 LF	_____.	_____.
0058	646.9000 Marking Removal Line 4-Inch	470.000 LF	_____.	_____.
0060	650.6501 Construction Staking Structure Layout (structure) 01. B-13-89	1.000 EACH	_____.	_____.
0062	715.0502 Incentive Strength Concrete Structures	500.000 DOL	1.00000	500.00



Proposal Schedule of Items

Proposal ID: 20230314001 Project(s): 1009-11-78

Federal ID(s): N/A

SECTION: 0001

Contract Items

Alt Set ID:

Alt Mbr ID:

Proposal Line Number	Item ID Description	Approximate Quantity and Units	Unit Price	Bid Amount
0064	SPV.0090 Special 01. Remove and Salvage Concrete Barrier	207.000 LF	_____.	_____.
	Section: 0001		Total:	_____.
			Total Bid:	_____.

PLEASE ATTACH ADDENDA HERE



Wisconsin Department of Transportation

February 28, 2023

Division of Transportation Systems Development

Bureau of Project Development
4822 Madison Yards Way, 4th Floor South
Madison, WI 53705

Telephone: (608) 266-1631
Facsimile (FAX): (608) 266-8459

NOTICE TO ALL CONTRACTORS:

Proposal #01: 1009-11-78
Madison – Portage
River Road Bridge B-13-89
IH 39
Dane County

Letting of March 14, 2023

This is Addendum No. 01, which provides for the following:

Plan Sheets:

Revised Plan Sheets	
Plan Sheet	Plan Sheet Title (brief description of changes to sheet)
9 - 22	SDD – Concrete Barrier Temporary Precast, 12'-6"

The responsibility for notifying potential subcontractors and suppliers of these changes remains with the prime contractor.

Sincerely,

Mike Coleman

Proposal Development Specialist
Proposal Management Section

END OF ADDENDUM

Addendum No. 01
ID 1009-11-78
Revised Sheet 10
February 28, 2023

CONCRETE BARRIER
TEMPORARY PRECAST,
12' - 6"

STATE OF WISCONSIN
DEPARTMENT OF TRANSPORTATION

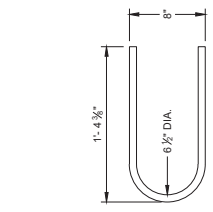

B5 BAR DETAIL

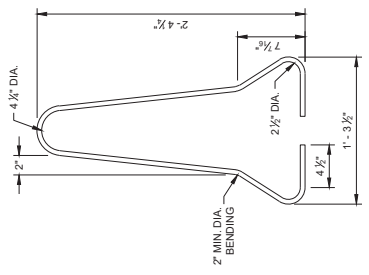

B4 BAR DETAIL

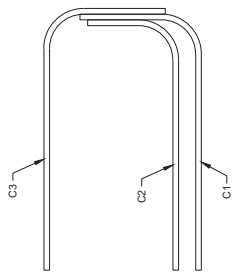

**PROFILE VIEW
LOOP BAR ASSEMBLY**

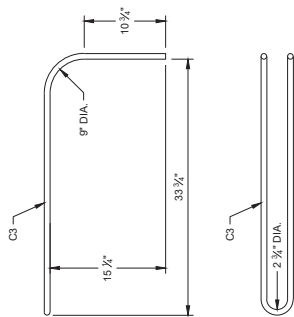
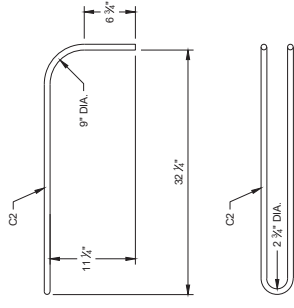
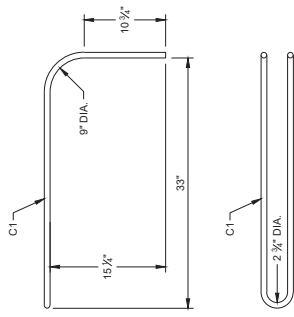

C BAR DETAILS

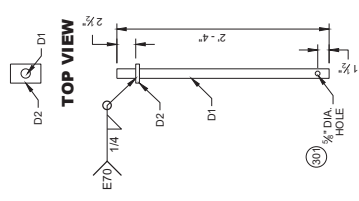

**PROFILE VIEW
CONNECTOR PIN
ASSEMBLY**

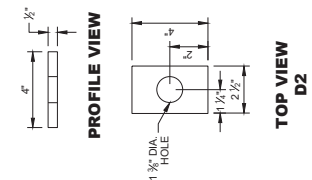

**CONNECTING TEMPORARY
BARRIER SECTIONS**

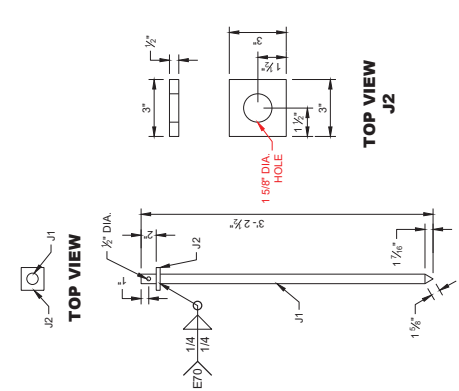

**PROFILE VIEW
ASPHALT ANCHOR PIN
ASSEMBLY**

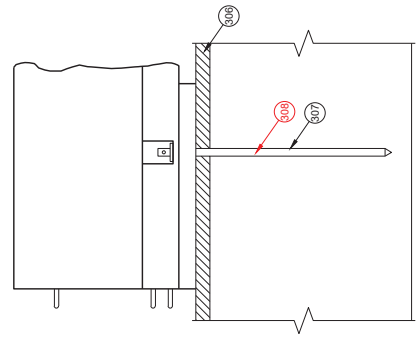

**SIDE VIEW
ASPHALT ANCHOR
INSTALLATION
THROUGH
ASPHALT PAVEMENT**

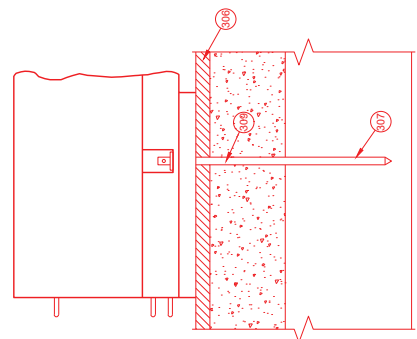

**SIDE VIEW
ASPHALT ANCHOR
INSTALLATION
THROUGH
ASPHALT OVERLAY
ON TOP OF
CONCRETE PAVEMENT**

- GENERAL NOTES**
- 309 SET WITH 3/4" WOOD BLOCK.
 - 307 HOLE IS OPTIONAL.
 - 302 CONNECTOR PIN ASSEMBLY.
 - 303 CONCRETE PAVEMENT, APPROACH SLAB, OR DECK.
 - 304 CONCRETE DECK.
 - 305 DO NOT USE ON CONCRETE BRIDGE DECK WITH ASPHALT OVERLAY OR CONCRETE PAVEMENT WITH ASPHALT OVERLAY.
 - 306 MINIMUM OF 2" OF ASPHALT.
 - 307 ASPHALT ANCHOR PIN ASSEMBLY.
 - 308 IF DRILLING A PILOT HOLE, THE MAX. DIA. OF THE HOLE IS 3/4".
 - 309 WHEN THERE IS ASPHALT OVERLAYING CONCRETE PAVEMENT, A 1 5/8" DIA. PILOT HOLE CAN BE DRILLED INTO THE OVERLAY AND CONCRETE. IF NEEDED DRILL A 3/4" PILOT HOLE IN BASE COURSE.

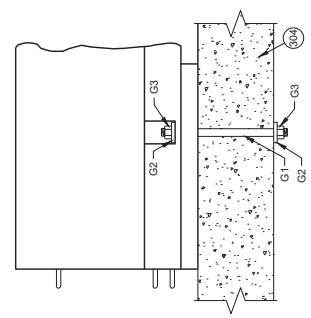

**SIDE VIEW
THROUGH BOLT ANCHOR
INSTALLATION**

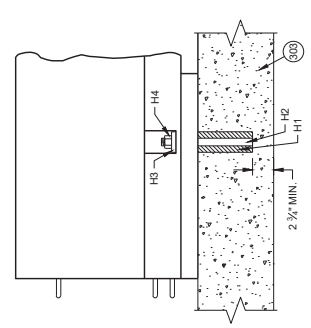

**SIDE VIEW
ADHESIVE ANCHOR
INSTALLATION**

Addendum No. 01
ID 1009-11-78
Revised Sheet 11
February 28, 2023

**CONCRETE BARRIER
TEMPORARY PRECAST,
12' - 6"**

STATE OF WISCONSIN
DEPARTMENT OF TRANSPORTATION

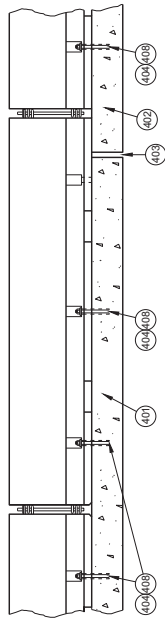

PROFILE VIEW
ANCHORED BARRIER NEAR EXPANSION JOINT (405)

GENERAL NOTES

- 400 NO SINGLE CONCRETE BARRIER SECTION SHALL BE ANCHORED TO BOTH THE BRIDGE DECK AND THE APPROACH SLAB. THE ANCHOR BOLT SHALL BE PLACED IN THE CONCRETE DECK AND THE APPROACH SLAB WITH THE DETAIL NO MORE THAN ONE ANCHOR BOLT SHALL BE ELIMINATED FROM A BARRIER SECTION WHEN SPANNING AN EXPANSION JOINT.
- 401 CONCRETE DECK
- 402 CONCRETE DECK OR APPROACH SLAB
- 403 EXPANSION JOINT
- 404 ADHESIVE ANCHOR SHOWN. SEE ANCHOR DETAILS.
- 405 ANCHORED TEMPORARY BARRIER
- 406 TRANSITION FROM ANCHORED TEMPORARY BARRIER TO FREE STANDING
- 407 REMOVE ALL ANCHORS WHEN NO LONGER NEEDED. FILL CONCRETE PAVEMENTS, DECKS AND APPROACH PAVEMENTS WITH ASTM D3960 TYPE I RUBBERIZED CRACK FILLER.
- 408 TRAFFIC SIDE
- 409 NON-TRAFFIC SIDE
- 410 ANCHOR LOCATION. SEE ANCHORING DETAILS.
- 411 WORK AREA
- 412 AREA FREE OF OBJECTS AND WORKERS
- 413 GRADE LINE
- 414 EXTENDED GRADE LINE
- 415 ANCHORED TEMPORARY BARRIER. SEE BOLT THROUGH DECK, REMOVABLE ADHESIVE ANCHOR, OR AN ASPHALT ANCHOR ROD DETAILS FOR MORE INFORMATION. ASPHALT ANCHOR ROD SHOWN.
- 416 WHEN OBJECT'S EXTEND ABOVE THE GRADE, A MINIMUM OF 1 FOOT IS REQUIRED FROM BACK OF BARRIER TO OBJECT.
- 417 OBJECTS ARE NOT TO BE PLACED ON, IN CONTACT TO, OR ALLOWED TO LEAN AGAINST THE BARRIER WITHOUT WRITTEN PERMISSION OF THE PROJECT ENGINEER.
- 418 DEPTHS OF 3 FEET OR MORE.
- 419 Y = 6.5'
- 420 OFFSET FROM BACK OF BARRIER EDGE:
CONCRETE PAVEMENT 1.0'
ASPHALT 0.5'
- 421 POSTED SPEED (MPH):
4.0' NUMBER
40 OR LOWER 2.0'

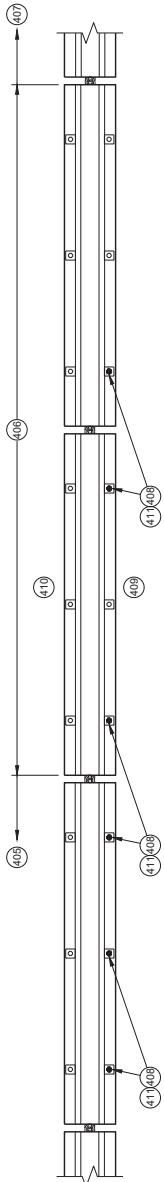

PLAN VIEW
TRANSITION FROM FREE STANDING TO ANCHORED BARRIER

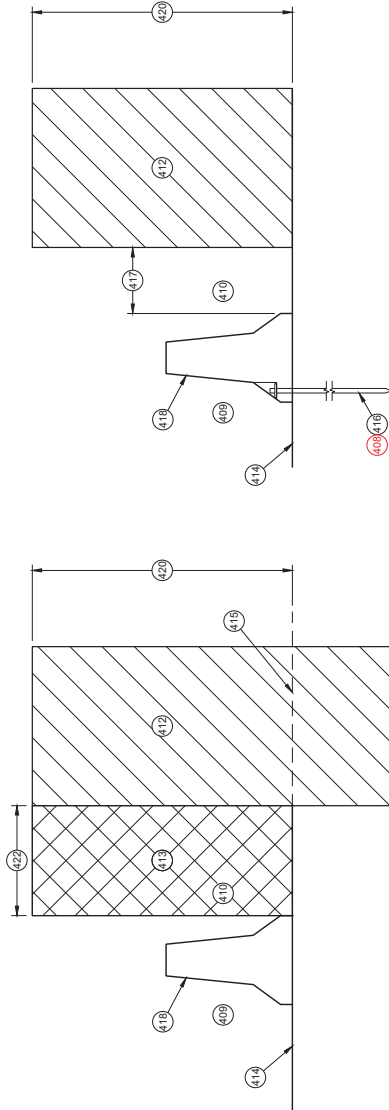

CROSS SECTION
FREE STANDING BARRIER

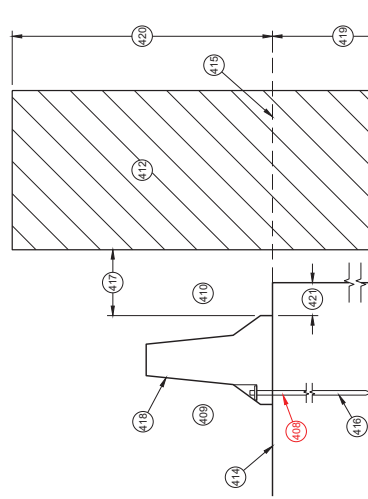
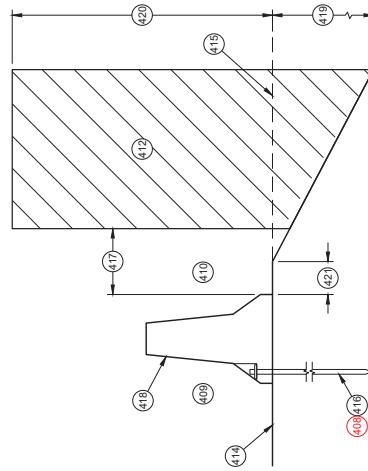

CROSS SECTION
ANCHORED BARRIER FOR OBJECTS ABOVE THE GRADE LINE AND NEAR THE BARRIER

CROSS SECTION
ANCHORED BARRIER NEAR A SLOPE

CROSS SECTION
ANCHORED BARRIER NEAR VERTICAL DROP OFF

Addendum No. 01
ID 1009-11-78
Revised Sheet 12
February 28, 2023

**CONCRETE BARRIER
TEMPORARY PRECAST,
12' - 6"**
STATE OF WISCONSIN
DEPARTMENT OF TRANSPORTATION

GENERAL NOTES

- 600 EXISTING RIGID BARRIERS (VARIES)
- 601 TEMPORARY BARRIER
- 602 SEE OTHER DETAIL ON HOW TO ANCHOR TEMPORARY BARRIER (BARRIER ASPHALT ANCHOR SHOWN).
- 603 ANCHORS ARE REQUIRED ON BOTH SIDE OF THE TEMPORARY BARRIER.
- 604 NESTED RAILS ARE REQUIRED ON BOTH SIDES OF THE TEMPORARY BARRIER FOR ALL INSTALLATIONS.
- 605 TRAFFIC TRAVELS FROM PERMANENT BARRIER TO TEMPORARY BARRIER.
- 606 TRAFFIC TRAVELS FROM TEMPORARY BARRIER TO PERMANENT BARRIER.
- 607 VERTICAL BARRIER
- 608 SAFETY SHAPE BARRIER
- 609 SINGLE SLOPE BARRIER
- 610 CAP END PLATE PLACED FLUSH WITH UPSTREAM END OF RIGID BARRIER.
- 611 BENT THRIE BEAM TO FIT.
- 612 THRIE BEAM PIECES ARE OFFSET 15'; TO PREVENT INTERFERENCE FROM THE ANCHORS ON OPPOSING SIDES.
- 613 TWO (2) P1, P2 AND P3 ARE REQUIRED
- 614 FIVE (5) N1, N2 AND N3 ARE REQUIRED
- 615 TWO (2) R1, R2 AND R3 ARE REQUIRED
- 616 CUT WOOD BLOCK TO FIT.
- 617 SEE THREE BEAM RAIL TERMINAL CONNECTOR DETAIL ASSEMBLY.
- 618 CAP ASSEMBLY
- 619 4" MAX. GAP BETWEEN TEMPORARY BARRIER AND RIGID BARRIER.
- 620 ALL TWELVE SPLICE HOLES REQUIRE M1 AND M2

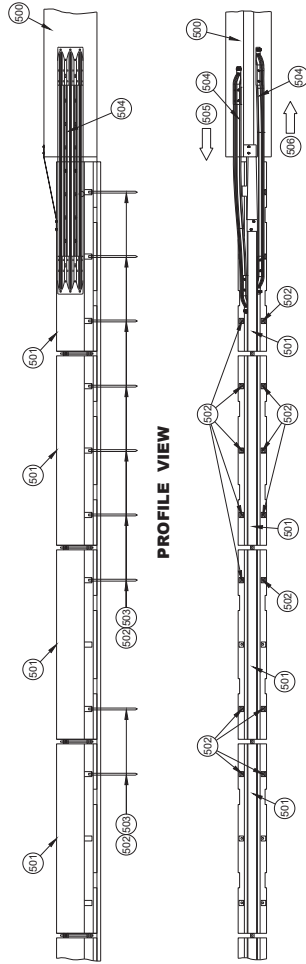

PROFILE VIEW

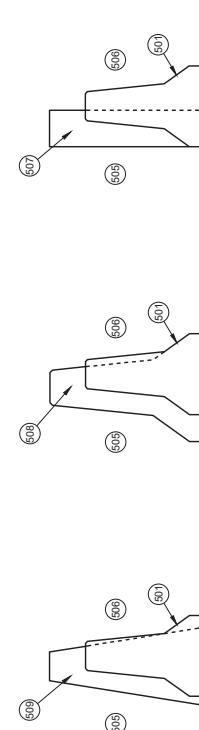

**CROSS SECTION
TEMPORARY BARRIER
PLACEMENT SINGLE SLOPE**

**CROSS SECTION
TEMPORARY BARRIER
PLACEMENT SAFETY SHAPE**

**CROSS SECTION
TEMPORARY BARRIER
PLACEMENT VERTICAL**

**PLAN VIEW
TRANSITION TO RIGID BARRIER**

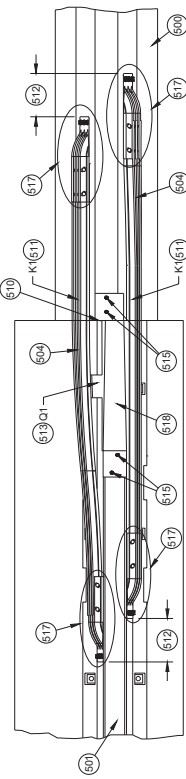

**PLAN DETAIL VIEW
TRANSITION TO RIGID BARRIER**

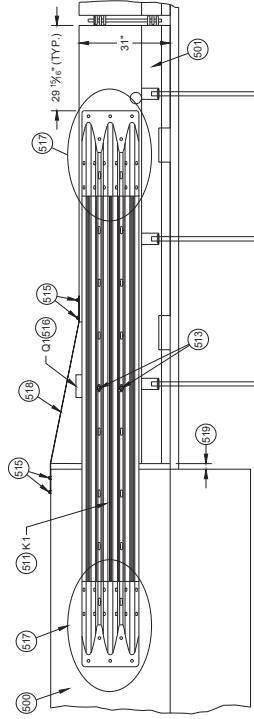

**BACK DETAIL VIEW
TRANSITION TO RIGID BARRIER**

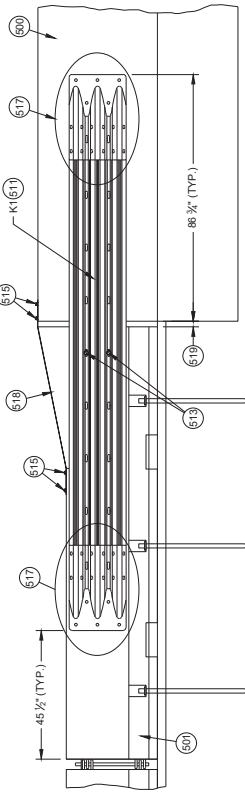

**FRONT DETAIL VIEW
TRANSITION TO RIGID BARRIER**

Addendum No. 01
ID 1009-11-78
Revised Sheet 13
February 28, 2023

**CONCRETE BARRIER
TEMPORARY PRECAST,
12' - 6"**

STATE OF WISCONSIN
DEPARTMENT OF TRANSPORTATION

**617 DETAIL PLAN VIEW
THRIE BEAM RAIL TERMINAL CONNECTOR ASSEMBLY**

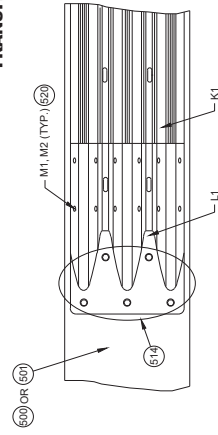

**CONCRETE BARRIER
TEMPORARY PRECAST,
12' - 6"**

STATE OF WISCONSIN
DEPARTMENT OF TRANSPORTATION

Addendum No. 01
ID 1009-11-78
Revised Sheet 14
February 28, 2023

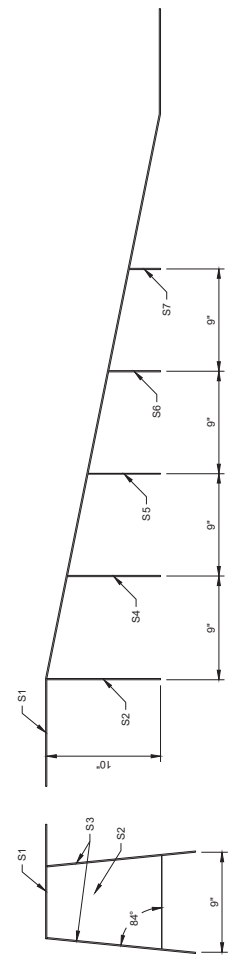
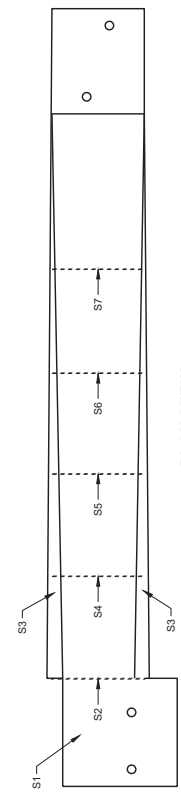
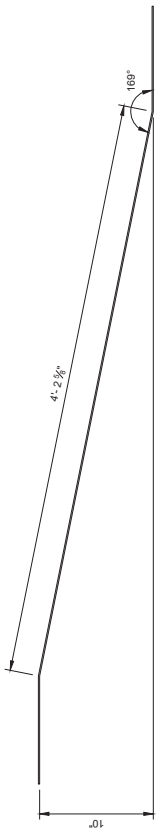
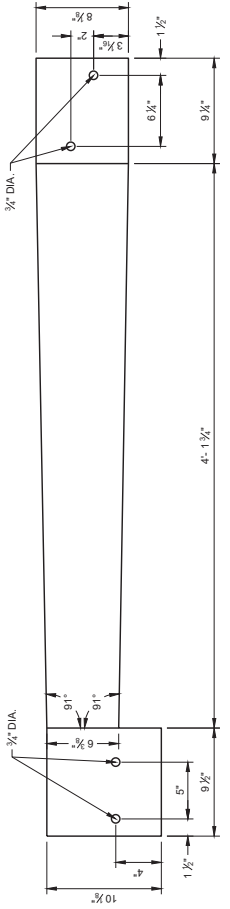
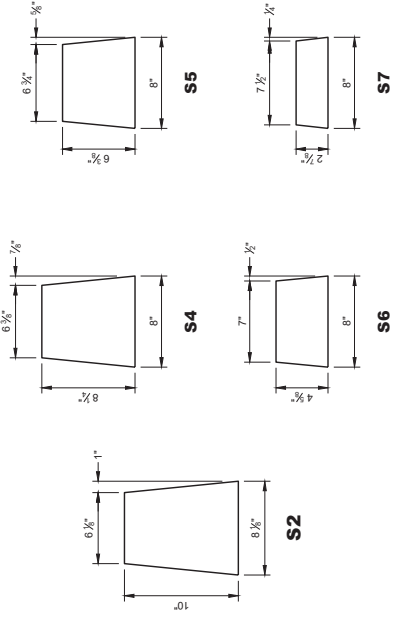
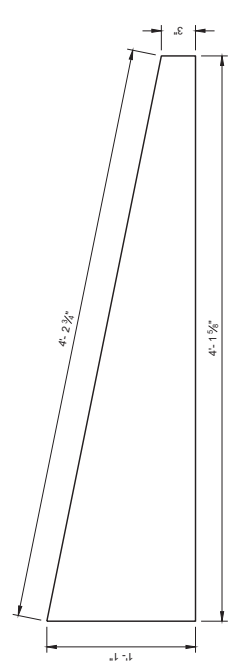

GENERAL NOTES
STITCH WELD GUSSET PLATES AND END PLATES ON THREE SIDES
STITCH WELD TWO SIDE PLATES TO TOP PLATE, END PLATE AND GUSSETS.
SIDE PLATES (S3) NOT SHOWN FOR CLARITY.

6

6

42" TOP CAP ASSEMBLY

GENERAL NOTES
 STITCH WELD GUSSET PLATES AND END PLATES ON THREE SIDES.
 STITCH WELD TWO SIDE PLATES TO TOP PLATE, END PLATE AND GUSSETS.
 SIDE PLATES, TOP PLATE, END PLATE AND GUSSETS ARE 12 GAUGE ASTM A36 GALVANIZED STEEL.
 (700) SIDE PLATES (T3 AND T4) NOT SHOWN FOR CLARITY.

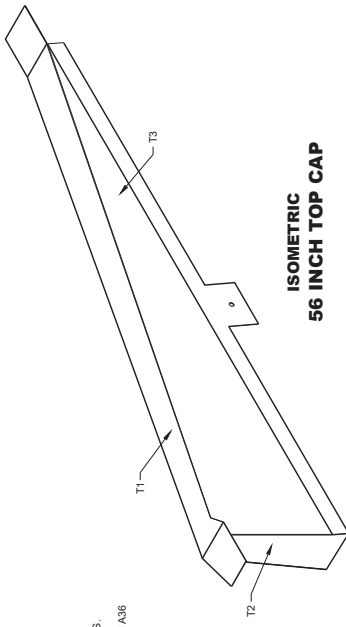

END VIEW

**ISOMETRIC
56 INCH TOP CAP**

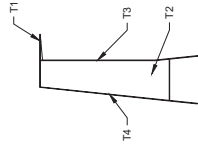

END VIEW

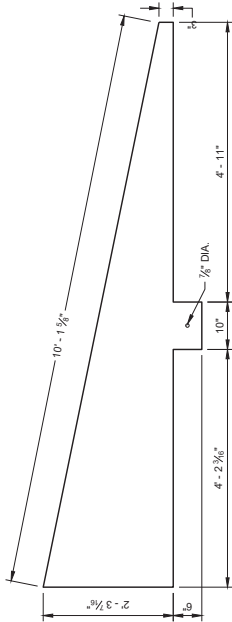

**SIDE VIEW
T4**

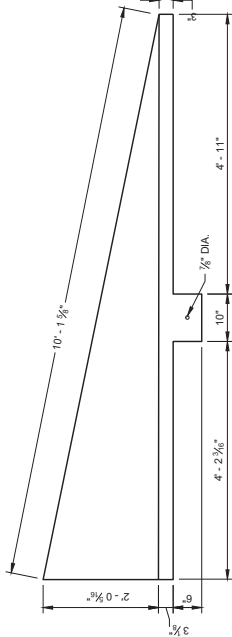

**SIDE VIEW
T3**

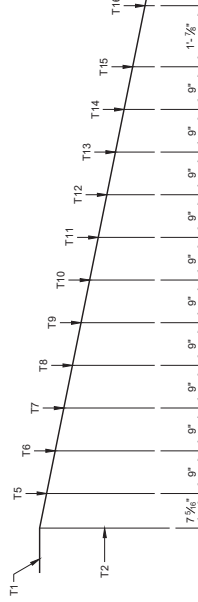

**SIDE VIEW
56 INCH TOP CAP
(700)**

**END VIEW
56 INCH TOP CAP**

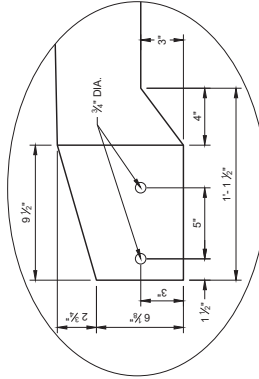

DETAIL "A"

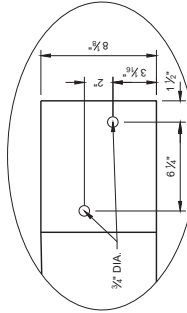

DETAIL "B"

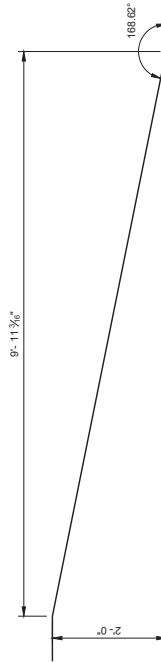

**SIDE VIEW
TOP PLATE T1**

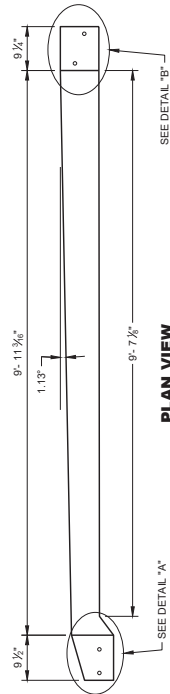

**PLAN VIEW
TOP PLATE T1**

GUSSET NO.	GUSSET DIMENSIONS			
	A	B	C	D
T5	22 3/8"	5 1/8"	2 3/8"	8 1/8"
T6	21"	5 1/4"	2 3/8"	8 1/8"
T7	19 3/4"	6 3/4"	1 13/16"	8 1/8"
T8	17 3/8"	6 1/4"	1 13/16"	8 1/8"
T9	15 3/8"	6 3/8"	1 1/2"	8 1/8"
T10	13 3/4"	6 3/4"	1 1/2"	8 1/8"
T11	11 1/8"	6 3/8"	1 1/2"	8 1/8"
T12	10 1/2"	7"	1 1/8"	8 1/8"
T13	8 3/4"	7 3/8"	1 1/8"	8 1/8"
T14	6 9/16"	7 3/4"	1 1/8"	8 1/8"
T15	4 1/8"	7 3/8"	1 1/4"	8"
T16	2 1/2"	7 3/4"	1 1/4"	8"

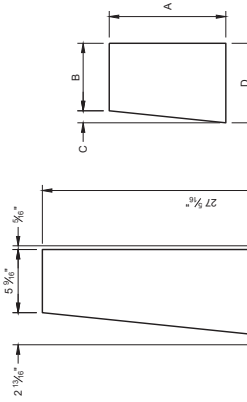

END PLATE T2

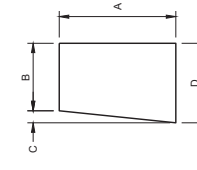

**GUSSET PLATES
T5 - T16**

**CONCRETE BARRIER
TEMPORARY PRECAST,
12' - 6"**
 STATE OF WISCONSIN
DEPARTMENT OF TRANSPORTATION

Addendum No. 01
ID 1009-11-78
Revised Sheet 15
February 28, 2023

Addendum No. 01
ID 1009-11-78
Revised Sheet 16
February 28, 2023

CONCRETE BARRIER
TEMPORARY PRECAST,
12' - 6"

STATE OF WISCONSIN
DEPARTMENT OF TRANSPORTATION

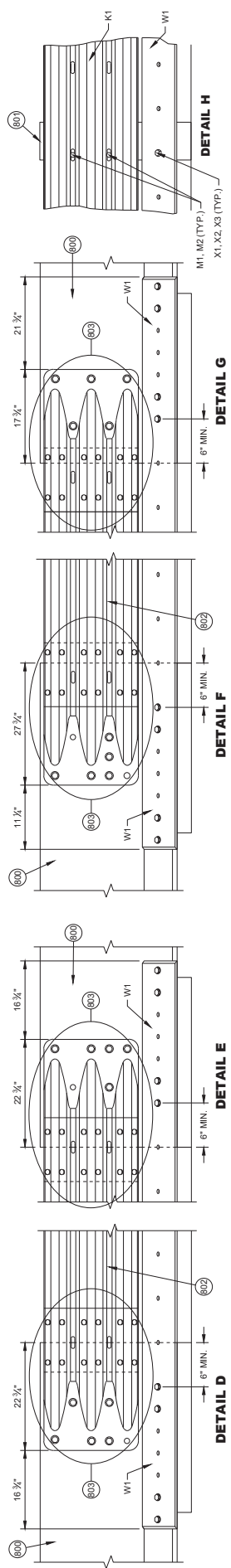

GENERAL NOTES

- 600 FREE STANDING TEMPORARY BARRIER
- 601 GAP STIFFENER ASSEMBLY
- 602 THRIE BEAMS ARE NESTED ON BOTH SIDES OF THE TEMPORARY BARRIER.
- 603 SEE THRIE BEAM RAIL TERMINAL CONNECTOR DETAIL

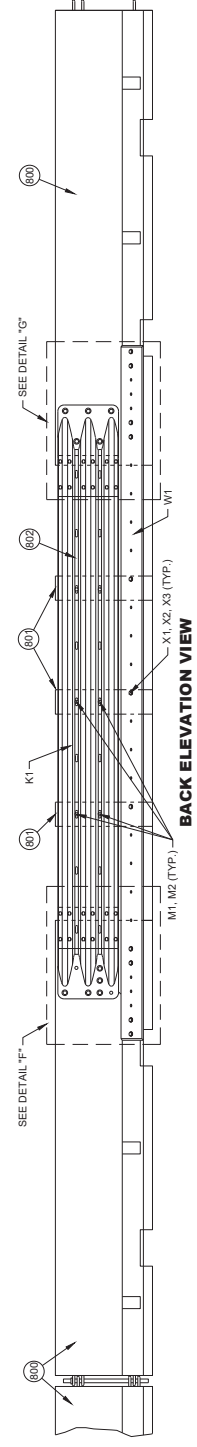
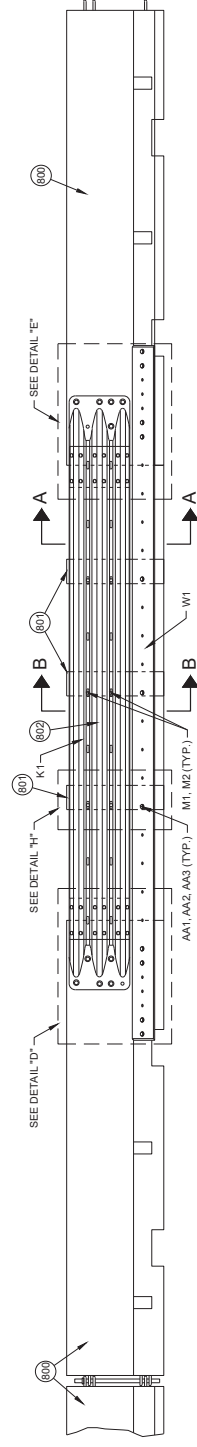
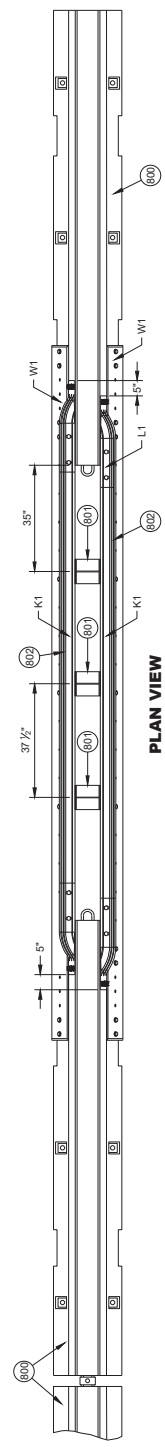

PORTABLE CONCRETE BARRIER GAP THRIE BEAM COVER

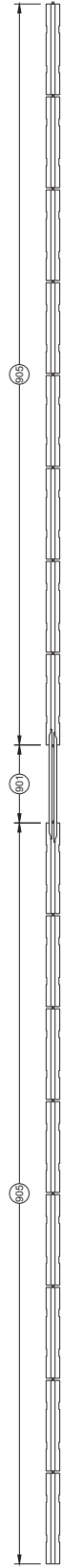

PLAN VIEW
GAP WITHIN SPACING

GENERAL NOTES

- 600 SEE OTHER DETAILS FOR TEMPORARY GAP-HARDWARE (TYP.)
- 601 TEMPORARY BARRIER GAP
- 602 GAP STIFFENER ASSEMBLY CENTERED IN THE GAP.
- 603 GAP STIFFENER ASSEMBLY IS OFFSET 18 3/4" FROM CENTER
- 604 MINIMUM NUMBER OF GAP STIFFENERS SHOWN FOR THE GAP RANGE SHOWN.
- 605 MINIMUM OF 8 CONTINUOUS FREE STANDING TEMPORARY BARRIERS

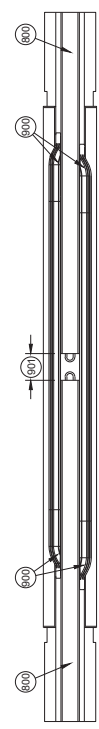

PLAN VIEW
TEMPORARY BARRIER GAP OVER 4" TO 1' MAX.

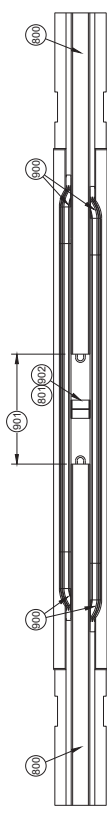

PLAN VIEW
TEMPORARY BARRIER GAP OVER 1' TO 4' MAX.

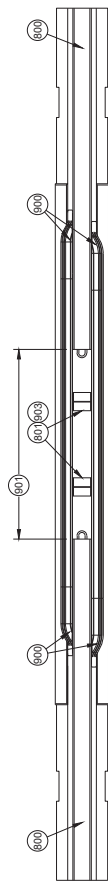

PLAN VIEW
TEMPORARY BARRIER GAP OVER 4' TO 7' MAX.

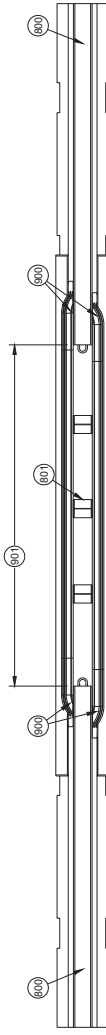

PLAN VIEW
TEMPORARY BARRIER GAP OVER 7' TO 12.5' MAX.

**CONCRETE BARRIER
TEMPORARY PRECAST,
12' - 6"**

STATE OF WISCONSIN
DEPARTMENT OF TRANSPORTATION

Addendum No. 01
ID 1009-11-78
Revised Sheet 17
February 28, 2023

CONCRETE BARRIER
 TEMPORARY PRECAST,
 12' - 6"

STATE OF WISCONSIN
 DEPARTMENT OF TRANSPORTATION

Addendum No. 01
 ID 1009-11-78
 Revised Sheet 18
 February 28, 2023

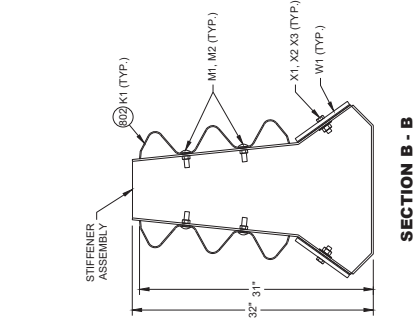

SECTION A - A

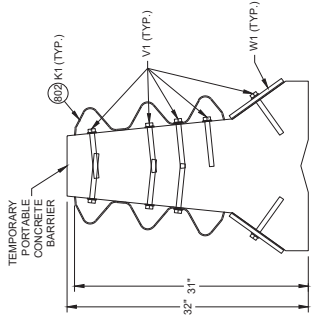

SECTION B - B

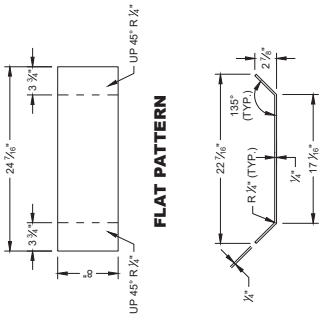

PROFILE VIEW
 STIFFENER ASSEMBLY
 BOTTOM PANEL U3

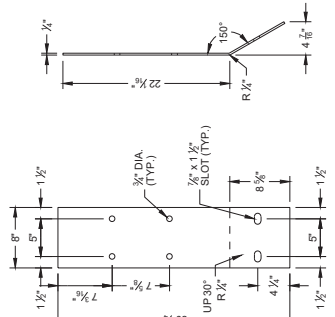

SIDE VIEW
 STIFFENER ASSEMBLY
 SIDE PANEL U2

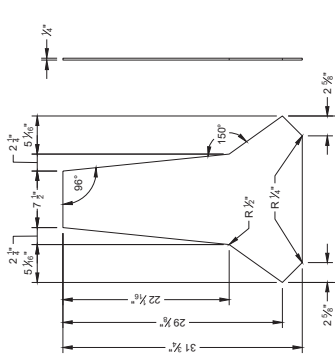

PROFILE VIEW
 STIFFENER ASSEMBLY
 CENTER PANEL U1

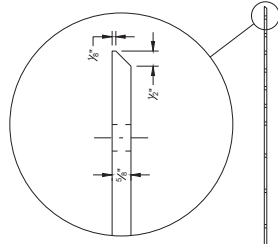

PLAN VIEW

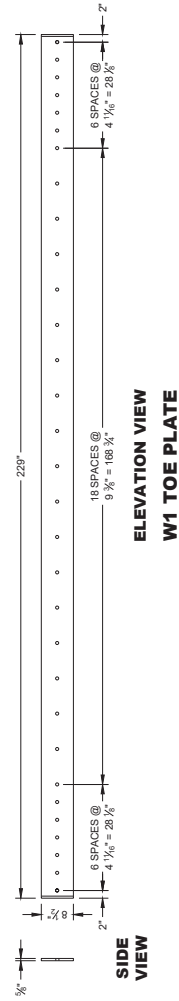

ELEVATION VIEW
 W1 TOE PLATE

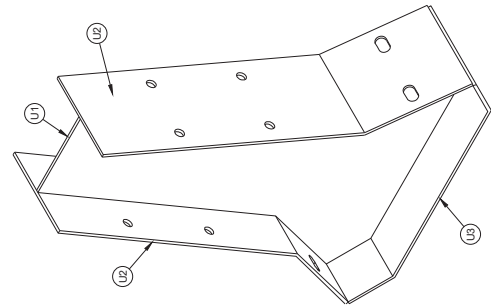

ISOMETRIC

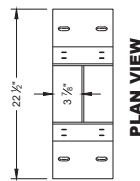

PLAN VIEW

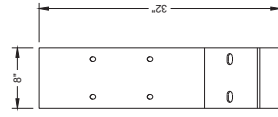

SIDE VIEW

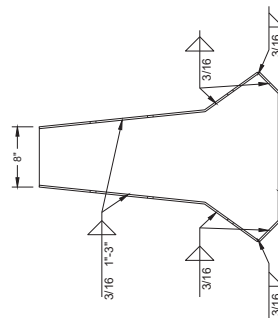

PROFILE VIEW

GAP STIFFENER ASSEMBLY

BILL OF MATERIALS - CONCRETE BARRIER PRECAST

PART	DESCRIPTION	MATERIALS SPECIFICATIONS	NOTES
T1	CAP 56-INCH TOP PLATE	ASHTO M117 / ASTM A123 ASTM A92 MIN. STRENGTH 36 KSI OR ASTM A529 MAX. STRENGTH 50 KSI OR ASTM A992 MAX. STRENGTH 50 KSI	12 GAUGE
T2	CAP 56-INCH END PLATE	ASHTO M117 / ASTM A123 ASTM A92 MIN. STRENGTH 36 KSI OR ASTM A529 MAX. STRENGTH 50 KSI OR ASTM A992 MAX. STRENGTH 50 KSI	12 GAUGE
T3	CAP 56-INCH SIDE PLATE 1	ASHTO M117 / ASTM A123 ASTM A92 MIN. STRENGTH 36 KSI OR ASTM A529 MAX. STRENGTH 50 KSI OR ASTM A992 MAX. STRENGTH 50 KSI	12 GAUGE
T4	CAP 56-INCH SIDE PLATE 2	ASHTO M117 / ASTM A123 ASTM A92 MIN. STRENGTH 36 KSI OR ASTM A529 MAX. STRENGTH 50 KSI OR ASTM A992 MAX. STRENGTH 50 KSI	12 GAUGE
T5	CAP 56-INCH GUSSET 1	ASHTO M117 / ASTM A123 ASTM A92 MIN. STRENGTH 36 KSI OR ASTM A529 MAX. STRENGTH 50 KSI OR ASTM A992 MAX. STRENGTH 50 KSI	12 GAUGE
T6	CAP 56-INCH GUSSET 2	ASHTO M117 / ASTM A123 ASTM A92 MIN. STRENGTH 36 KSI OR ASTM A529 MAX. STRENGTH 50 KSI OR ASTM A992 MAX. STRENGTH 50 KSI	12 GAUGE
T7	CAP 56-INCH GUSSET 3	ASHTO M117 / ASTM A123 ASTM A92 MIN. STRENGTH 36 KSI OR ASTM A529 MAX. STRENGTH 50 KSI OR ASTM A992 MAX. STRENGTH 50 KSI	12 GAUGE
T8	CAP 42-INCH GUSSET 4	ASHTO M117 / ASTM A123 ASTM A92 MIN. STRENGTH 36 KSI OR ASTM A529 MAX. STRENGTH 50 KSI OR ASTM A992 MAX. STRENGTH 50 KSI	12 GAUGE
T9	CAP 42-INCH GUSSET 5	ASHTO M117 / ASTM A123 ASTM A92 MIN. STRENGTH 36 KSI OR ASTM A529 MAX. STRENGTH 50 KSI OR ASTM A992 MAX. STRENGTH 50 KSI	12 GAUGE
T10	CAP 42-INCH GUSSET 6	ASHTO M117 / ASTM A123 ASTM A92 MIN. STRENGTH 36 KSI OR ASTM A529 MAX. STRENGTH 50 KSI OR ASTM A992 MAX. STRENGTH 50 KSI	12 GAUGE
T11	CAP 42-INCH GUSSET 7	ASHTO M117 / ASTM A123 ASTM A92 MIN. STRENGTH 36 KSI OR ASTM A529 MAX. STRENGTH 50 KSI OR ASTM A992 MAX. STRENGTH 50 KSI	12 GAUGE
T12	CAP 42-INCH GUSSET 8	ASHTO M117 / ASTM A123 ASTM A92 MIN. STRENGTH 36 KSI OR ASTM A529 MAX. STRENGTH 50 KSI OR ASTM A992 MAX. STRENGTH 50 KSI	12 GAUGE
T13	CAP 42-INCH GUSSET 9	ASHTO M117 / ASTM A123 ASTM A92 MIN. STRENGTH 36 KSI OR ASTM A529 MAX. STRENGTH 50 KSI OR ASTM A992 MAX. STRENGTH 50 KSI	12 GAUGE
T14	CAP 42-INCH GUSSET 10	ASHTO M117 / ASTM A123 ASTM A92 MIN. STRENGTH 36 KSI OR ASTM A529 MAX. STRENGTH 50 KSI OR ASTM A992 MAX. STRENGTH 50 KSI	12 GAUGE
T15	CAP 42-INCH GUSSET 11	ASHTO M117 / ASTM A123 ASTM A92 MIN. STRENGTH 36 KSI OR ASTM A529 MAX. STRENGTH 50 KSI OR ASTM A992 MAX. STRENGTH 50 KSI	12 GAUGE
T16	CAP 42-INCH GUSSET 12	ASHTO M117 / ASTM A123 ASTM A92 MIN. STRENGTH 36 KSI OR ASTM A529 MAX. STRENGTH 50 KSI OR ASTM A992 MAX. STRENGTH 50 KSI	12 GAUGE
U1	GAP STIFFENER	ASHTO M117 / ASTM A123 ASTM A92 MIN. STRENGTH 36 KSI OR ASTM A529 MAX. STRENGTH 50 KSI OR ASTM A992 MAX. STRENGTH 50 KSI	12 GAUGE
U2	GAP STIFFENER - CONNECTION PLATE 1	ASHTO M117 / ASTM A123 ASTM A92 MIN. STRENGTH 36 KSI OR ASTM A529 MAX. STRENGTH 50 KSI OR ASTM A992 MAX. STRENGTH 50 KSI	12 GAUGE
U3	GAP STIFFENER - CONNECTOR PLATE 2	ASHTO M117 / ASTM A123 ASTM A92 MIN. STRENGTH 36 KSI OR ASTM A529 MAX. STRENGTH 50 KSI OR ASTM A992 MAX. STRENGTH 50 KSI	12 GAUGE

PART	DESCRIPTION	MATERIALS SPECIFICATIONS	NOTES
V1	THREE BEAM RAIL TERMINAL MECHANICAL OR ADHESIVE ANCHOR	MINIMUM MECHANICAL OR ADHESIVE ANCHOR STRENGTH REQUIREMENTS ULTIMATE TENSILE LOAD 24.0 KIIPS AND ULTIMATE SHEAR LOAD 21.5 KIIPS. SEE 603.2 AND 603.3.1.2 OF THE WISCONSIN STANDARD SPECIFICATIONS FOR MORE INFORMATION ON ADHESIVE ANCHORS.	3/4" DIA.
V2	GAP STIFFENER - BOLT - NUT	HOT DIP ASHTO M232 CLASS C / ASTM A143 CLASS C / ASTM F2329 C OR MECHANICAL GALVANIZE TO ASHTO M286 CLASS 50 TYPE 1 / ASTM B895 CLASS 50 TYPE 1 UNC OVER HEX HEAD OR ASHTO M286 CLASS 50 TYPE 1 / ASTM B895 CLASS 50 TYPE 1 UNC OVER SAE J429 GRADE 5 HEAVY HEX HEAD / ASTM A448 TYPE 1 HEAVY HEX HEAD. BOLTS MAY BE FULLY THREADED. PROVIDE ENOUGH THREADING FOR PROPER TIGHTENING OF BOLT.	
V1	TOE PLATE	ASHTO M117 / ASTM A123 ASTM A92 MIN. STRENGTH 36 KSI OR ASTM A529 MAX. STRENGTH 50 KSI OR ASTM A992 MAX. STRENGTH 50 KSI	
X1	TOE PLATE - CONNECTION BOLT	HOT DIP ASHTO M232 CLASS C / ASTM A143 CLASS C / ASTM F2329 C OR MECHANICAL GALVANIZE TO ASHTO M286 CLASS 50 TYPE 1 / ASTM B895 CLASS 50 TYPE 1 UNC OVER SAE J429 GRADE 5 HEAVY HEX HEAD / ASTM A448 TYPE 1 HEAVY HEX HEAD. BOLTS MAY BE FULLY THREADED. PROVIDE ENOUGH THREADING FOR PROPER TIGHTENING OF BOLT.	3/4" DIA.
X2	TOE PLATE - CONNECTION BOLT - WASHER	HOT DIP ASHTO M232 CLASS C / ASTM A143 CLASS C / ASTM F2329 C OR MECHANICAL GALVANIZE TO ASHTO M286 CLASS 50 TYPE 1 / ASTM B895 CLASS 50 TYPE 1 UNC OVER SAE J429 GRADE 5 HEAVY HEX HEAD / ASTM A448 TYPE 1 HEAVY HEX HEAD. BOLTS MAY BE FULLY THREADED. PROVIDE ENOUGH THREADING FOR PROPER TIGHTENING OF BOLT.	
X3	TOE PLATE - CONNECTION BOLT - NUT	HOT DIP ASHTO M232 CLASS C / ASTM A143 CLASS C / ASTM F2329 C OR MECHANICAL GALVANIZE TO ASHTO M286 CLASS 50 TYPE 1 / ASTM B895 CLASS 50 TYPE 1 UNC OVER SAE J429 GRADE 5 HEAVY HEX HEAD / ASTM A448 TYPE 1 HEAVY HEX HEAD. BOLTS MAY BE FULLY THREADED. PROVIDE ENOUGH THREADING FOR PROPER TIGHTENING OF BOLT.	

Addendum No. 01
ID 1009-11-78
Revised Sheet 22
February 28, 2023

**CONCRETE BARRIER
TEMPORARY PRECAST,
12' - 6"**

STATE OF WISCONSIN
DEPARTMENT OF TRANSPORTATION

APPROVED
February 28, 2023
DATE
RST/ Rodney Taylor
ROADWAY STRUCTURES DEVELOPMENT
ENGINEER

