

# HIGHWAY WORK PROPOSAL

Wisconsin Department of Transportation  
DT1502 01/2020 s.66.0901(7) Wis. Stats

Proposal Number: **033**

<u>COUNTY</u>	<u>STATE PROJECT</u>	<u>FEDERAL</u>	<u>PROJECT DESCRIPTION</u>	<u>HIGHWAY</u>
Chippewa	7070-06-72	N/A	Augusta - Cadott; Eau Claire/Chippewa Co Ln to STH 29	STH 027

## ADDENDUM REQUIRED ATTACHED AT BACK

This proposal, submitted by the undersigned bidder to the Wisconsin Department of Transportation, is in accordance with the advertised request for proposals. The bidder is to furnish and deliver all materials, and to perform all work for the improvement of the designated project in the time specified, in accordance with the appended Proposal Requirements and Conditions.

Proposal Guaranty Required: \$75,000.00 Payable to: Wisconsin Department of Transportation	Attach Proposal Guaranty on back of this PAGE.
Bid Submittal Date: December 12, 2023 Time (Local Time): 11:00 am	Firm Name, Address, City, State, Zip Code
Contract Completion Time 60 Working Days	<b>SAMPLE NOT FOR BIDDING PURPOSES</b>
Assigned Disadvantaged Business Enterprise Goal 0%	This contract is exempt from federal oversight.

This certifies that the undersigned bidder, duly sworn, is an authorized representative of the firm named above; that the bidder has examined and carefully prepared the bid from the plans, Highway Work Proposal, and all addenda, and has checked the same in detail before submitting this proposal or bid; and that the bidder or agents, officer, or employees have not, either directly or indirectly, entered into any agreement, participated in any collusion, or otherwise taken any action in restraint of free competitive bidding in connection with this proposal bid.

**Do not sign, notarize, or submit this Highway Work Proposal when submitting an electronic bid on the Internet.**

Subscribed and sworn to before me this date \_\_\_\_\_

\_\_\_\_\_  
(Signature, Notary Public, State of Wisconsin)

\_\_\_\_\_  
(Bidder Signature)

\_\_\_\_\_  
(Print or Type Name, Notary Public, State Wisconsin)

\_\_\_\_\_  
(Print or Type Bidder Name)

\_\_\_\_\_  
(Date Commission Expires)

\_\_\_\_\_  
(Bidder Title)

Notary Seal

<b>Type of Work:</b> Excavation, Base, Concrete Pavement, HMA Pavement, Asphaltic Surface, Curb and Gutter, Beam Guard, Pavement Marking, Structure Rehabilitation, Culvert Pipes.	<b>For Department Use Only</b>
Notice of Award Dated	Date Guaranty Returned

**PLEASE ATTACH  
PROPOSAL GUARANTY HERE**

## PROPOSAL REQUIREMENTS AND CONDITIONS

The bidder, signing and submitting this proposal, agrees and declares as a condition thereof, to be bound by the following conditions and requirements.

If the bidder has a corporate relationship with the proposal design engineering company, the bidder declares that it did not obtain any facts, data, or other information related to this proposal from the design engineering company that was not available to all bidders.

The bidder declares that they have carefully examined the site of, and the proposal, plans, specifications and contract forms for the work contemplated, and it is assumed that the bidder has investigated and is satisfied as to the conditions to be encountered, as to the character, quality, and quantities of work to be performed and materials to be furnished, and as to the requirements of the specifications, special provisions and contract. It is mutually agreed that submission of a proposal shall be considered conclusive evidence that the bidder has made such examination.

The bidder submits herewith a proposal guaranty in proper form and amount payable to the party as designated in the advertisement inviting proposals, to be retained by and become the property of the owner of the work in the event the undersigned shall fail to execute the contract and contract bond and return the same to the office of the engineer within fourteen (14) days after having been notified in writing to do so; otherwise to be returned.

The bidder declares that they understand that the estimate of quantities in the attached schedule is approximate only and that the attached quantities may be greater or less in accordance with the specifications.

The bidder agrees to perform the said work, for and in consideration of the payment of the amount becoming due on account of work performed, according to the unit prices bid in the following schedule, and to accept such amounts in full payment of said work.

The bidder declares that all of the said work will be performed at their own proper cost and expense, that they will furnish all necessary materials, labor, tools, machinery, apparatus, and other means of construction in the manner provided in the applicable specifications and the approved plans for the work together with all standard and special designs that may be designed on such plans, and the special provisions in the contract of which this proposal will become a part, if and when accepted. The bidder further agrees that the applicable specifications and all plans and working drawings are made a part hereof, as fully and completely as if attached hereto.

The bidder, if awarded the contract, agrees to begin the work not later than ten (10) days after the date of written notification from the engineer to do so, unless otherwise stipulated in the special provisions.

The bidder declares that if they are awarded the contract, they will execute the contract agreement and begin and complete the work within the time named herein, and they will file a good and sufficient surety bond for the amount of the contract for performance and also for the full amount of the contract for payment.

The bidder, if awarded the contract, shall pay all claims as required by Section 779.14, Statutes of Wisconsin, and shall be subject to and discharge all liabilities for injuries pursuant to Chapter 102 of the Statutes of Wisconsin, and all acts amendatory thereto. They shall further be responsible for any damages to property or injury to persons occurring through their own negligence or that of their employees or agents, incident to the performance of work under this contract, pursuant to the Standard Specifications for Road and Bridge Construction applicable to this contract.

In connection with the performance of work under this contract, the contractor agrees to comply with all applicable state and federal statutes relating to non-discrimination in employment. No otherwise qualified person shall be excluded from employment or otherwise be subject to discrimination in employment in any manner on the basis of age, race, religion, color, gender, national origin or ancestry, disability, arrest or conviction record (in keeping with s.111.32), sexual orientation, marital status, membership in the military reserve, honesty testing, genetic testing, and outside use of lawful products. This provision shall include, but not be limited to the following: employment, upgrading, demotion or transfer; recruitment or recruitment advertising; layoff or termination; rates of pay or other forms of compensation, and selection for training, including apprenticeship. The contractor further agrees to ensure equal opportunity in employment to all applicants and employees and to take affirmative action to attain a representative workforce.

The contractor agrees to post notices and posters setting forth the provisions of the nondiscrimination clause, in a conspicuous and easily accessible place, available for employees and applicants for employment.

If a state public official (section 19.42, Stats.) or an organization in which a state public official holds at least a 10% interest is a party to this agreement, this contract is voidable by the state unless appropriate disclosure is made to the State of Wisconsin Ethics Board.

## BID PREPARATION

### Preparing the Proposal Schedule of Items

#### A. General

- (1) Obtain bidding proposals as specified in section 102 of the standard specifications prior to 11:45 AM of the last business day preceding the letting. Submit bidding proposals using one of the following methods:
  1. Electronic bid on the internet.
  2. Electronic bid on a printout with accompanying diskette or CD ROM.
  3. Paper bid under a waiver of the electronic submittal requirements.
- (2) Bids submitted on a printout with accompanying diskette or CD ROM or paper bids submitted under a waiver of the electronic submittal requirements govern over bids submitted on the internet.
- (3) The department will provide bidding information through the department's web site at:

<https://wisconsin.gov/Pages/doing-bus/contractors/hcci/bid-let.aspx>

The contractor is responsible for reviewing this web site for general notices as well as information regarding proposals in each letting. The department will also post special notices of all addenda to each proposal through this web site no later than 4:00 PM local time on the Thursday before the letting. Check the department's web site after 5:00 PM local time on the Thursday before the letting to ensure all addenda have been accounted for before preparing the bid. When bidding using methods 1 and 2 above, check the Bid Express™ on-line bidding exchange at <http://www.bidx.com/> after 5:00 PM local time on the Thursday before the letting to ensure that the latest schedule of items Expedite file (\*.ebs or \*.00x) is used to submit the final bid.

- (4) Interested parties can subscribe to the Bid Express™ on-line bidding exchange by following the instructions provided at the [www.bidx.com](http://www.bidx.com) web site or by contacting:

Info Tech Inc.  
5700 SW 34th Street, Suite 1235  
Gainesville, FL 32608-5371  
email: <mailto:customer.support@bidx.com>

- (5) The department will address equipment and process failures, if the bidder can demonstrate that those failures were beyond their control.
- (6) Contractors are responsible for checking on the issuance of addenda and for obtaining the addenda. Notice of issuance of addenda is posted on the department's web site at:

<https://wisconsin.gov/Pages/doing-bus/contractors/hcci/bid-let.aspx>

or by calling the department at (608) 266-1631. Addenda can ONLY be obtained from the department's web site listed above or by picking up the addenda at the Bureau of Highway Construction, 4th floor, 4822 Madison Yards Way, Madison, WI, during regular business hours.

- (7) Addenda posted after 5:00 PM on the Thursday before the letting will be emailed to the eligible bidders for that proposal. All eligible bidders shall acknowledge receipt of the addenda whether they are bidding on the proposal or not. Not acknowledging receipt may jeopardize the awarding of the project.

## B. Submitting Electronic Bids

### B.1 On the Internet

- (1) Do the following before submitting the bid:
  4. Have a properly executed annual bid bond on file with the department.
  5. Have a digital ID on file with and enabled by Info Tech Inc. Using this digital ID will constitute the bidder's signature for proper execution of the bidding proposal.
- (2) In lieu of preparing, delivering, and submitting the proposal as specified in 102.6 and 102.9 of the standard specifications, submit the proposal on the internet as follows:
  1. Download the latest schedule of items reflecting all addenda from the Bid Express™ web site.
  2. Use Expedite™ software to enter a unit price for every item in the schedule of items.
  3. Submit the bid according to the requirements of Expedite™ software and the Bid Express™ web site. Do not submit a bid on a printout with accompanying diskette or CD ROM or a paper bid. If the bidder does submit a bid on a printout with accompanying diskette or a paper bid in addition to the internet submittal, the department will disregard the internet bid.
  4. Submit the bid before the hour and date the Notice to Contractors designates.
  5. Do not sign, notarize, and return the bidding proposal described in 102.2 of the standard specifications.
- (3) The department will not consider the bid accepted until the hour and date the Notice to Contractors designates.

### B.2 On a Printout with Accompanying Diskette or CD ROM

- (1) Download the latest schedule of items from the Wisconsin pages of the Bid Express web site reflecting the latest addenda posted on the department's web site at:  
<https://wisconsin.gov/Pages/doing-bus/contractors/hcci/bid-let.aspx>  
 Use Expedite™ software to prepare and print the schedule of items. Provide a valid amount for all price fields. Follow instructions and review the help screens provided on the Bid Express™ web site to assure that the schedule of items is prepared properly.

- (2) Staple an 8 1/2 by 11 inch printout of the Expedite™ generated schedule of items to the other proposal documents submitted to the department as a part of the bidder's sealed bid. As a separate submittal, not in the sealed bid envelope but due at the same time and place as the sealed bid, also provide the Expedite™ generated schedule of items on a 3 1/2 inch computer diskette or CD ROM. Label each diskette or CD ROM with the bidder's name, the 4 character department-assigned bidder identification code from the top of the bidding proposal, and a list of the proposal numbers included on that diskette or CD ROM as indicated in the following example:

**Bidder Name**

**BN00**

**Proposals: 1, 12, 14, & 22**

- (3) If bidding on more than one proposal in the letting, the bidder may include all proposals for that letting on one diskette or CD ROM. Include only submitted proposals with no incomplete or other files on the diskette or CD ROM.
- (4) The bidder-submitted printout of the Expedite™ generated schedule of items is the governing contract document and must conform to the requirements of section 102 of the standard specifications. If a printout needs to be altered, cross out the printed information with ink or typewriter and enter the new information and initial it in ink. If there is a discrepancy between the printout and the diskette or CD ROM, the department will analyze the bid using the printout information.

- (5) In addition to the reasons specified in section 102 of the standard specifications, proposals are irregular and the department may reject them for one or more of the following:
1. The check code printed on the bottom of the printout of the Expedite™ generated schedule of items is not the same on each page.
  2. The check code printed on the printout of the Expedite™ generated schedule of items is not the same as the check code for that proposal provided on the diskette or CD ROM.
  3. The diskette or CD ROM is not submitted at the time and place the department designates.

**B Waiver of Electronic Submittal**

- (1) The bidder may request a waiver of the electronic submittal requirements. Submit a written request for a waiver in lieu of bids submitted on the internet or on a printout with accompanying diskette or CD ROM. Use the waiver that was included with the paper bid document sent to the bidder or type up a waiver on the bidder's letterhead. The department will waive the electronic submittal requirements for a bidding entity (individual, partnership, joint venture, corporation, or limited liability company) for up to 4 individual proposals in a calendar year. The department may allow additional waivers for equipment malfunctions.
- (2) Submit a schedule of items on paper conforming to section 102 of the standard specifications. The department charges the bidder a \$75 administrative fee per proposal, payable at the time and place the department designates for receiving bids, to cover the costs of data entry. The department will accept a check or money order payable to: "Wisconsin, Dept. of Transportation."
- (3) In addition to the reasons specified in section 102 of the standard specifications, proposals are irregular and the department may reject them for one or more of the following:
  1. The bidder fails to provide the written request for waiver of the electronic submittal requirements.
  2. The bidder fails to pay the \$75 administrative fee before the time the department designates for the opening of bids unless the bidder requests on the waiver that they be billed for the \$75.
  3. The bidder exceeds 4 waivers of electronic submittal requirements within a calendar year.
- (4) In addition to the reasons specified in section 102 of the standard specifications, the department may refuse to issue bidding proposals for future contracts to a bidding entity that owes the department administrative fees for a waiver of electronic submittal requirements.

**PROPOSAL BID BOND**

DT1303 1/2006

Wisconsin Department of Transportation

Proposal Number	Project Number	Letting Date
Name of Principal		
Name of Surety	State in Which Surety is Organized	

We, the above-named Principal and the above-named Surety, are held and firmly bound unto the State of Wisconsin in the sum equal to the Proposal Guaranty for the total bid submitted for the payment to be made; we jointly and severally bind ourselves, our heirs, executors, administrators, successors and assigns. The condition of this obligation is that the Principal has submitted a bid proposal to the State of Wisconsin acting through the Department of Transportation for the improvement designated by the Proposal Number and Letting Date indicated above.

If the Principal is awarded the contract and, within the time and manner required by law after the prescribed forms are presented for signature, enters into a written contract in accordance with the bid, and files the bond with the Department of Transportation to guarantee faithful performance and payment for labor and materials, as required by law, or if the Department of Transportation shall reject all bids for the work described, then this obligation shall be null and void; otherwise, it shall be and remain in full force and effect. In the event of failure of the Principal to enter into the contract or give the specified bond, the Principal shall pay to the Department of Transportation **within 10 business days of demand** a total equal to the Proposal Guaranty as liquidated damages; the liability of the Surety continues for the full amount of the obligation as stated until the obligation is paid in full.

The Surety, for value received, agrees that the obligations of it and its bond shall not be impaired or affected by any extension of time within which the Department of Transportation may accept the bid; and the Surety does waive notice of any such extension.

IN WITNESS, the Principal and Surety have agreed and have signed by their proper officers and have caused their corporate seals to be affixed this date: **(DATE MUST BE ENTERED)**

**PRINCIPAL**

\_\_\_\_\_  
(Company Name) **(Affix Corporate Seal)**

\_\_\_\_\_  
(Signature and Title)

\_\_\_\_\_  
(Company Name)

\_\_\_\_\_  
(Signature and Title)

\_\_\_\_\_  
(Company Name)

\_\_\_\_\_  
(Signature and Title)

\_\_\_\_\_  
(Company Name)

\_\_\_\_\_  
(Signature and Title)

\_\_\_\_\_  
(Name of Surety) **(Affix Seal)**

\_\_\_\_\_  
(Signature of Attorney-in-Fact)

**NOTARY FOR PRINCIPAL**

\_\_\_\_\_  
(Date)

State of Wisconsin )  
 ) ss.  
\_\_\_\_\_ County )

On the above date, this instrument was acknowledged before me by the named person(s).

\_\_\_\_\_  
(Signature, Notary Public, State of Wisconsin)

\_\_\_\_\_  
(Print or Type Name, Notary Public, State of Wisconsin)

\_\_\_\_\_  
(Date Commission Expires)

**Notary Seal**

**NOTARY FOR SURETY**

\_\_\_\_\_  
(Date)

State of Wisconsin )  
 ) ss.  
\_\_\_\_\_ County )

On the above date, this instrument was acknowledged before me by the named person(s).

\_\_\_\_\_  
(Signature, Notary Public, State of Wisconsin)

\_\_\_\_\_  
(Print or Type Name, Notary Public, State of Wisconsin)

\_\_\_\_\_  
(Date Commission Expires)

**Notary Seal**

**IMPORTANT: A certified copy of Power of Attorney of the signatory agent must be attached to the bid bond.**



# CERTIFICATE OF ANNUAL BID BOND

DT1305 8/2003

Wisconsin Department of Transportation

Time Period Valid (From/To)
Name of Surety
Name of Contractor
Certificate Holder Wisconsin Department of Transportation

This is to certify that an annual bid bond issued by the above-named Surety is currently on file with the Wisconsin Department of Transportation.

This certificate is issued as a matter of information and conveys no rights upon the certificate holder and does not amend, extend or alter the coverage of the annual bid bond.

**Cancellation:** Should the above policy be cancelled before the expiration date, the issuing surety will give thirty (30) days written notice to the certificate holder indicated above.

\_\_\_\_\_  
(Signature of Authorized Contractor Representative)

\_\_\_\_\_  
(Date)



## **CERTIFICATION REGARDING DEBARMENT, SUSPENSION, AND OTHER RESPONSIBILITY MATTERS - PRIMARY COVERED TRANSACTIONS**

### Instructions for Certification

1. By signing and submitting this proposal, the prospective contractor is providing the certification set out below.
2. The inability of a person to provide the certification required below will not necessarily result in denial of participation in this covered transaction. The prospective contractor shall submit an explanation of why it cannot provide the certification set out below. The certification or explanation will be considered in connection with the department or agency's determination whether to enter into this transaction. However, failure of the prospective contractor to furnish a certification or an explanation shall disqualify such person from participation in this transaction.
3. The certification in this clause is a material representation of fact upon which reliance was placed when the department determined to enter into this transaction. If it is later determined that the contractor knowingly rendered an erroneous certification in addition to other remedies available to the Federal Government the department may terminate this transaction for cause or default.
4. The prospective contractor shall provide immediate written notice to the department to whom this proposal is submitted if at any time the prospective contractor learns that its certification was erroneous when submitted or has become erroneous by reason of changed circumstances.
5. The terms "covered transaction," "debarred," "suspended," "ineligible," "lower tier covered transaction," "participant," "person," "primary covered transaction," "principal," "proposal," and "voluntarily excluded," as used in this clause, have the meanings set out in the Definitions and Coverage sections of the rules implementing Executive Order 12549. You may contact the department to which this proposal is being submitted for assistance in obtaining a copy of those regulations.
6. The prospective contractor agrees by submitting this proposal that, should this contract be entered into, it shall not knowingly enter into any lower tier covered transaction with a person who is debarred, suspended, declared ineligible, or voluntarily excluded from participation in this covered transaction, unless authorized by the department entering into this transaction.
7. The prospective contractor further agrees by submitting this proposal that it will include the clause titled "Certification Regarding Debarment, Suspension, Ineligibility and Voluntary Exclusion-Lower Tier Covered Transaction," which is included as an addendum to PR- 1273 - "Required Contract Provisions Federal Aid Construction Contracts," without modification, in all lower tier covered transactions and in all solicitations for lower tier covered transactions.
8. The contractor may rely upon a certification of a prospective subcontractor/materials supplier that it is not debarred, suspended, ineligible, or voluntarily excluded from the covered transaction, unless it knows that the certification is erroneous. A contractor may decide the method and frequency by which it determines the eligibility of its principals. Each contractor may, but is not required to, check the Disapproval List (telephone # 608/266/1631).

9. Nothing contained in the foregoing shall be construed to require establishment of a system of records in order to render in good faith the certification required by this clause. The knowledge and information of a contractor is not required to exceed that which is normally possessed by a prudent person in the ordinary course of business dealings.
10. Except for transactions authorized under paragraph 6 of these instructions, if a contractor in a covered transaction knowingly enters into a lower tier covered transaction with a person who is suspended, debarred, ineligible or voluntarily excluded from participation in this transaction, in addition to other remedies available to the Federal Government, the department may terminate this transaction for cause or default.

Certification Regarding Debarment, Suspension, and Other Responsibility Matters - Primary Covered Transactions

1. The prospective contractor certifies to the best of its knowledge and belief, that it and its principals:
  - (a) Are not presently debarred, suspended, proposed for debarment, declared ineligible, or voluntarily excluded from covered transactions by any Federal department or agency;
  - (b) Have not within a three-year period preceding this proposal been convicted of or had a civil judgment rendered against them for commission of fraud or a criminal offense in connection with obtaining, attempting to obtain, or performing a public (Federal, State or local) transaction or contract under a public transaction; violation of Federal or State antitrust statutes or commission of embezzlement, theft, forgery, bribery, falsification or destruction of records, making false statements or receiving stolen property;
  - (c) Are not presently indicted for or otherwise criminally or civilly charged by a governmental entity (Federal, State or local) with commission of any of the offense enumerated in paragraph (1)(b) of this certification; and
  - (d) Have not within a three-year period preceding this proposal had one or more public transactions (Federal, State or local) terminated for cause or default.
2. Where the prospective contractor is unable to certify to any of the statements in this certification, such prospective contractor shall attach an explanation to this proposal.

## Special Provisions

### Table of Contents

Article	Description	Page #
1.	General.....	2
2.	Scope of Work.....	2
3.	Prosecution and Progress.....	2
4.	Traffic.....	3
5.	Holiday and Special Event Work Restrictions.....	4
6.	Utilities.....	4
7.	Information to Bidders, U.S. Army Corps of Engineers Section 404 Permit.....	5
8.	Information to Bidders, WPDES Transportation Construction General Permit (TCGP) for Storm Water Discharges.....	5
9.	Environmental Protection, Aquatic Exotic Species Control.....	6
10.	Coordination with County Surveyor.....	6
11.	Abatement of Asbestos Containing Material B-9-26, Item 203.0211.S.01.....	6
12.	Temporary Lane Shift During Culvert Work, Item 208.1500.S.....	7
13.	Backfill Controlled Low Strength, Item 209.0200.S.....	8
14.	Prepare Foundation for CIR Base Layer 7070-06-72, Item 211.0700.S.01.....	9
15.	Base Repair for CIR Layer, Item 211.0800.S.....	9
16.	Cold In-Place Recycling (CIR) Asphaltic Base Layer, Item 327.1000.S; Asphalt Stabilizing Agent, Item 455.0770.S.....	10
17.	HMA Percent Within Limits (PWL) Test Strip Volumetrics, Item 460.0105.S; HMA Percent Within Limits (PWL) Test Strip Density, Item 460.0110.S.....	20
18.	Cleaning Decks to Reapply Concrete Masonry Overlay, Item 509.0505.S.....	24
19.	Removing Concrete Masonry Deck Overlay B-9-26, Item 509.9005.S.01.....	25
20.	Removing Asphaltic Concrete Deck Overlay B-9-26, Item 509.9010.S.01.....	26
21.	Temporary Marking Line Epoxy 6-Inch, Item 643.3170.....	27
22.	Locating No-Passing Zones, Item 648.0100.....	27
23.	Partially Grouted Riprap, Item SPV.0035.01.....	27
24.	HMA Pavement Percent Within Limits (PWL) QMP, Core Pilot Project; Incentive Density PWL HMA Pavement, Item SPV.0055.01; Incentive Air Voids HMA Pavement SPV.0055.02.....	29
25.	Appendix A, Core Pilot Project.....	36
26.	HMA Pavement Longitudinal Joint Density, Core Pilot Project; Incentive Density HMA Pavement Longitudinal Joints, Item SPV.0055.03.....	39
27.	Ditch Cleaning, Item SPV.0090.01.....	42

## STSP'S Revised June 29, 2023

### SPECIAL PROVISIONS

#### 1. General.

Perform the work under this construction contract for Project 7070-06-72, Augusta – Cadott, Eau Claire/Chippewa Co Ln to STH 29, STH 27, Chippewa County, Wisconsin as the plans show and execute the work as specified in the State of Wisconsin, Department of Transportation, Standard Specifications for Highway and Structure Construction, 2024 Edition, as published by the department, and these special provisions.

If all or a portion of the plans and special provisions are developed in the SI metric system and the schedule of prices is developed in the US standard measure system, the department will pay for the work as bid in the US standard system.

100-005 (20230629)

#### 2. Scope of Work.

The work under this contract shall consist of cold-in-place recycling, HMA pavement, concrete deck overlay on B-9-26, culvert pipe work, base aggregate dense, guardrail replacement, pavement marking, rumble strips, and all incidental items necessary to complete the work as shown on the plans and included in the proposal and contract.

104-005 (20090901)

#### 3. Prosecution and Progress.

Begin work within 10 calendar days after the engineer issues a written notice to do so.

Provide the time frame for construction of the project within the 2024 construction season to the engineer in writing within a month after executing the contract but at least 14 calendar days before the preconstruction conference. Assure that the time frame is consistent with the contract completion time. Upon approval, the engineer will issue the notice to proceed within ten calendar days before the beginning of the approved time frame.

To revise the time frame, submit a written request to the engineer at least two weeks before the beginning of the intended time frame. The engineer will approve or deny that request based on the conditions cited in the request and its effect on the department's scheduled resources.

The Notice to Proceed will be issued such that work shall start no later than July 5, 2024, unless otherwise approved by the engineer.

#### Fish Spawning

There shall be no instream disturbance of waterways at Stations 69+78, 95+35, 101+81, 126+52, 138+48, 175+02, 191+52, 196+26, 223+03, 242+78, or 258+55 as a result of construction activity under or for this contract, from March 15 to May 15 both dates inclusive, in order to avoid adverse impacts upon the spawning of fish species.

Any change to this limitation will require submitting a written request by the contractor to the engineer, subsequent review and concurrence by the Department of Natural Resources in the request, and final approval by the engineer. The approval will include all conditions to the request as mutually agreed upon by WisDOT and DNR.

#### Northern Long-eared Bat (*Myotis septentrionalis*)

Northern long-eared bats (NLEB) have the potential to inhabit the project limits because they roost in trees, bridges, and culverts. Roosts may not have been observed on this project, but conditions to support the species exist. The species and all active roosts are protected by the federal Endangered Species Act. If an individual bat or active roost is encountered during construction operations, stop work, and notify the engineer and the WisDOT Regional Environmental Coordinator (REC).

Ensure all operators, employees, and subcontractors working in areas of known or presumed bat habitat are aware of environmental commitments and avoidance and minimization measures (AMMs) to protect both bats and their habitat.

Direct temporary lighting, if used, away from wooded areas during the bat active season April 1 to October 31, both dates inclusive.

The department has contracted with others and will perform the following operations after October 31 and prior to April 1:

- Cutting down and removing trees.

Contractor means and methods to remove additional trees will not be allowed. If it is determined that additional trees with a 3-inch or greater diameter at breast height (dbh) need to be removed beyond contractor means and methods, notify the engineer to coordinate with the WisDOT REC to determine if consultation with United States Fish and Wildlife Service (USFWS) is required. The contractor must be aware that the WisDOT REC and/or USFWS may not permit modifications.

#### **4. Traffic.**

Keep STH 27 and side roads open to traffic at all times for cold-in-place recycling and paving operations. During construction hours, close up to one lane of traffic as necessary with standard flagging operation. During non-working hours, open STH 27 and side roads to two lanes of traffic, one in each direction.

Keep STH 27 open to traffic at all times while replacing cross culverts. During construction hours, close up to one lane of traffic as necessary with standard flagging operation. If installation of cross culvert takes more than one construction day, open STH 27 during non-working hours to two lanes of traffic by installing base course up to the grade of existing asphalt and install traffic control as detailed in the plan. Cover base course with asphaltic surface within 96 hours and prior to any holiday work restrictions.

Maintain all private and field entrance access for local residents and emergency vehicles at all times throughout construction.

Place G20-57 fixed message signs at project termini 7 days prior to construction beginning and remove once construction begins.

##### **B-9-26 Stage 1**

Install traffic control for stage 1 as shown in the plans.

Complete the following items of work for the northbound STH 27 traffic lanes prior to shifting to stage 2:

- Bridge work as indicated in structure plans
- Concrete pavement approach slabs and concrete curb and gutter
- Asphaltic surface approaches
- MGS Thrie Beam Transition, MGS Guardrail, MGS Terminal EAT
- Temporary pavement marking

##### **B-9-26 Stage 2**

Install traffic control for stage 2 as shown in the plans.

Complete the following items of work for the southbound STH 27 traffic lanes prior to fully opening:

- Bridge work as indicated in structure plans
- Concrete pavement approach slabs and concrete curb and gutter
- Asphaltic surface approaches
- MGS Thrie Beam Transition, MGS Guardrail, MGS Terminal EAT
- Temporary pavement marking

**Wisconsin Lane Closure System Advance Notification**

Provide the following advance notification to the engineer for incorporation into the Wisconsin Lane Closure System (LCS).

**TABLE 108-1 CLOSURE TYPE AND REQUIRED MINIMUM ADVANCE NOTIFICATION**

<b>Closure type with height, weight, or width restrictions (available width, all lanes in one direction &lt; 16 feet)</b>	<b>MINIMUM NOTIFICATION</b>
Lane and shoulder closures	7 calendar days
Full roadway closures	7 calendar days
Ramp closures	7 calendar days
Detours	7 calendar days
<b>Closure type without height, weight, or width restrictions (available width, all lanes in one direction ≥ 16 feet)</b>	<b>MINIMUM NOTIFICATION</b>
Shoulder closures	3 calendar days
Lane closures	3 business days
Ramp closures	3 business days
Modifying all closure types	3 business days

Discuss LCS completion dates and provide changes in the schedule to the engineer at weekly project meetings in order to manage closures nearing their completion date.

**Temporary Work Zone Clear Zone Working Restrictions**

Park equipment and store materials, including stockpiles, a minimum of 10-feet from the edge of the traveled way unless protected by concrete barrier temporary precast.

If the contractor is unsure whether an individual work operation will meet the safety requirements for working within the clear zone, review the proposed work operation with the engineer before proceeding with the work.

ner-104-005 (20200227)

**5. Holiday and Special Event Work Restrictions.**

Do not perform work on, nor haul materials of any kind along or across any portion of the highway carrying STH 27 traffic, and entirely clear the traveled way and shoulders of such portions of the highway of equipment, barricades, signs, lights, and any other material that might impede the free flow of traffic during the following holiday and special event periods:

- From noon Friday, May 24 to 6:00 AM Tuesday, May 28, 2024 for Memorial Day;
- From noon Wednesday, July 3 to 6:00 AM Monday, July 8, 2024 for Independence Day;
- From noon Monday, August 12, to 6:00 AM Friday, August 16, 2024 for Farm Technology Days;
- From noon Friday, August 30 to 6:00 AM Tuesday, September 3, 2024 for Labor Day.

stp-107-005 (20210113)

*Supplement STP 107-005 with the following:*

Liquidated damages per standard spec 108.11 of the standard specifications will be assessed for failure to open the roadway to traffic if work occurs during the holiday time periods.

**6. Utilities.**

This contract comes under the provision of Administrative Rule Trans 220.

stp-107-065 (20080501)



The following utility owners have facilities within the project area; however, no adjustments are anticipated:

- Cadott Light and Water (Electricity)**
- CenturyLink Com LLC (Communication Line)**
- Eau Claire Energy Cooperative (Electricity)**
- Magellan Pipeline (Gas/Petroleum)**
- Spectrum (Communication Line)**
- We Energies (Gas/Petroleum)**
- Xcel Energy (Electricity – Transmission)**
- Xcel Energy (Electricity)**

## **7. Information to Bidders, U.S. Army Corps of Engineers Section 404 Permit.**

The department has assumed coverage under the U.S. Army Corps of Engineers Section 404 Transportation Regional General Permit (TRGP). The department has determined that a pre-construction notification (permit application) to U.S. Army Corps of Engineers and their written verification of TRGP coverage is not necessary for this project.

A copy of the Section 404 Transportation Regional General Permit can be obtained on USACE's website:

<https://www.mvp.usace.army.mil/Portals/57/docs/regulatory/RGP/Transportation.pdf>

If the contractor requires work outside the proposed slope intercepts, based on their method of operation to construct the project, it is the contractor's responsibility to determine whether a pre-construction notification (permit application) and written verification from U.S. Army Corps of Engineers under the Section 404 Transportation Regional General permit is required. If written verification under the TRGP is necessary, submit a pre-construction notification to U.S. Army Corps of Engineers and obtain written verification of permit coverage prior to beginning construction operations requiring the permit. No time extensions as discussed in standard spec 108.10 will be granted for the time required to apply for and obtain the written verification of permit coverage. The contractor must be aware that the U.S. Army Corps of Engineers may not grant the permit request.

stp-107-054 (20230629)

## **8. Information to Bidders, WPDES Transportation Construction General Permit (TCGP) for Storm Water Discharges.**

The department has obtained permit coverage through the Wisconsin Department of Natural Resources to discharge storm water associated with land disturbing construction activities under this contract. Conform to all permit requirements for the project.

This permit is the Wisconsin Pollutant Discharge Elimination System, Transportation Construction General Permit, (WPDES Permit No. WI-S066796-2). The permit can be found at:

<https://widnr.widen.net/s/s5mwp2gd7s/finalsignedwisdotcsgp>

A certificate of permit coverage is available from the regional office by contacting Joshua Lang at (920) 362-6170 or [Joshua.Lang@dot.wi.gov](mailto:Joshua.Lang@dot.wi.gov). Post the permit certificate in a conspicuous place at the construction site.

stp-107-056 (20230629)

## 9. Environmental Protection, Aquatic Exotic Species Control.

Exotic invasive organisms such as VHS, zebra mussels, purple loosestrife, and Eurasian water milfoil are becoming more prolific in Wisconsin and pose adverse effects to waters of the state. Wisconsin State Statutes 30.07, "Transportation of Aquatic Plants and Animals; Placement of Objects in Navigable Waters", details the state law that requires the removal of aquatic plants and zebra mussels each time equipment is put into state waters.

At construction sites that involve navigable water or wetlands, use the follow cleaning procedures to minimize the chance of exotic invasive species infestation. Use these procedures for all equipment that comes in contact with waters of the state and/or infested water or potentially infested water in other states.

Ensure that all equipment that has been in contact with waters of the state, or with infested or potentially infested waters, has been decontaminated for aquatic plant materials and zebra mussels before being used in other waters of the state. Before using equipment on this project, thoroughly disinfect all equipment that has come into contact with potentially infested waters. Guidelines from the Wisconsin Department of Natural Resources for disinfection are available at:

<http://dnr.wi.gov/topic/invasives/disinfection.html>

Use the following inspection and removal procedures:

1. Before leaving the contaminated site, wash machinery and ensure that the machinery is free of all soil and other substances that could possibly contain exotic invasive species;
2. Drain all water from boats, trailers, bilges, live wells, coolers, bait buckets, engine compartments, and any other area where water may be trapped;
3. Inspect boat hulls, propellers, trailers and other surfaces. Scrape off any attached mussels, remove any aquatic plant materials (fragments, stems, leaves, seeds, or roots), and dispose of removed mussels and plant materials in a garbage can before leaving the area or invested waters; and
4. Disinfect your boat, equipment and gear by either:
  - 4.1. Washing with ~212 F water (steam clean), or
  - 4.2. Drying thoroughly for five days after cleaning with soap and water and/or high pressure water, or
  - 4.3. Disinfecting with either 200 ppm (0.5 oz per gallon or 1 Tablespoon per gallon) Chlorine for 10-minute contact time or 1:100 solution (38 grams per gallon) of Virkon Aquatic for 20- to 30-minute contact time. Note: Virkon is not registered to kill zebra mussel veligers nor invertebrates like spiny water flea. Therefore, this disinfect should be used in conjunction with a hot water (>104° F) application.

Complete the inspection and removal procedure before equipment is brought to the project site and before the equipment leaves the project site.

stp-107-055 (20130615)

## 10. Coordination with County Surveyor.

Section corner monuments will be impacted by the project and are shown within the construction plans. Coordinate with the Chippewa County Surveyor's Office to perpetuate and re-monument these section corners. Contact the Surveyor's Office prior to construction and again at the completion of paving operations so that the Surveyor's Office can appropriately coordinate re-monumentation with construction activities.

Sam Wenz  
711 N Bridge St  
Chippewa Falls, WI 54729  
[swenz@co.chippewa.wi.us](mailto:swenz@co.chippewa.wi.us)  
(715) 726-7931

## 11. Abatement of Asbestos Containing Material B-9-26, Item 203.0211.S.01.

### A Description

This special provision describes abating asbestos containing material on structures.

**B (Vacant)**

**C Construction**

John Roelke, License Number All-119523, inspected Structure B-9-26 for asbestos on September 23, 2019. Regulated Asbestos Containing Material (RACM) was found on this structure in the following locations and quantities: Caulk for the parapet expansion joints contains 6’ x 1.5” x 8 locations = 6 SF.

The RACM on this structure must be abated by a licensed abatement contractor. A copy of the inspection report is included in the bid package or available from Joshua Lang at 920-362-6170 or [Joshua.Lang@dot.wi.gov](mailto:Joshua.Lang@dot.wi.gov). According to NR447 and DHS159, ensure that DNR or DHS receives a completed Notification of Demolition and/or Renovation (DNR Form 4500-113 (R 3/20), or subsequent revision) via U.S. mail, hand-delivery, or using the online notification system at least 10 working days before beginning any construction or demolition. Pay all associated fees. Provide a copy of the completed 4500-113 form and the abatement report to Joshua Lang at 920-362-6170 or [Joshua.Lang@dot.wi.gov](mailto:Joshua.Lang@dot.wi.gov) and via email to [dothazmatunit@dot.wi.gov](mailto:dothazmatunit@dot.wi.gov) or via US mail to DOT BTS-ESS attn: Hazardous Materials Specialist, 5 South S.513.12, PO Box 7965, Madison, WI 53707-7965. In addition, comply with all local or municipal asbestos requirements.

Use the following information to complete WisDNR form 4500-113:

- Site Name: Structure B-9-26, STH 27 over Paint Creek
- Site Address: 2.5M N JCT CTH X and 3.4M S JCT CTH MM
- Ownership Information: WisDOT Transportation NW-Eau Claire Region, 718 W Clairemont Ave, Eau Claire, WI 54701
- Contact: Joshua Lang
- Phone: (920) 362-6170
- Age: 71 years. This structure was constructed in 1962.
- Area: 3312 SF of deck

Insert the following paragraph in Section 6.g.:

- If asbestos not previously identified is found or previously non-friable asbestos becomes crumbled, pulverized, or reduced to a powder, stop work immediately, notify the engineer, and the engineer will notify the department’s Bureau of Technical Services at (608) 266-1476 for an emergency response as specified in standard spec 107.24. Keep material wet until it is abated or until it is determined to be non-asbestos containing material.

**D Measurement**

The department will measure Abatement of Asbestos Containing Material B-9-26 by each structure, acceptably completed.

**E Payment**

The department will pay for measured quantities at the contract unit price under the following bid item:

ITEM NUMBER	DESCRIPTION	UNIT
203.0211.S.01	Abatement of Asbestos Containing Material B-9-26	EACH

Payment is full compensation for submitting necessary forms; removing all asbestos; and for properly disposing of all waste materials.

stp-203-005 (20220628)

**12. Temporary Lane Shift During Culvert Work, Item 208.1500.S.**

**A Description**

This special provision describes the construction of a temporary lane shift to maintain traffic with a one-lane roadway around culvert work.

**B (Vacant)**

**C Construction**

Place fill and base aggregate dense as needed to maintain traffic through the lane shift.

Furnish materials and construct conforming to the following standard specs:

Common excavation, material removal, and disposal .....	205
Borrow.....	208
Base Aggregate Dense.....	305

Do pertinent construction staking according to standard spec 650 for the temporary lane shift.

Construct to appropriate widths and material thicknesses. Remove materials once the lane shift is no longer needed to maintain traffic.

**D Measurement**

The department will measure Temporary Lane Shift During Culvert Work as a single unit for each temporary roadway, acceptably completed.

**E Payment**

The department will pay for measured quantities at the contract unit price under the following bid item:

ITEM NUMBER	DESCRIPTION	UNIT
208.1500.S	Temporary Lane Shift During Culvert Work	EACH

Payment is full compensation for placing, removing and disposal of fill material, including any base aggregate dense used for the driving surface; and associated construction staking.

The department will pay separately for traffic control and erosion control items.

stp-208-010 (20210708)

**13. Backfill Controlled Low Strength, Item 209.0200.S.**

**A Description**

This special provision describes furnishing and placing a controlled low strength material designed for use as backfill in trenches for culverts, sewers, utilities, or similar structures, as backfill behind bridges abutments, or as fill for the abandonment of culverts, pipes, or tanks.

**B Materials**

Provide controlled low strength backfill that consists of a designed cementitious mixture of natural or processed materials. Allowable materials include natural sand, natural gravel, produced sand, foundry sand, produced gravel, fly ash, Portland cement, and other broken or fragmented mineral materials. The designed mixture shall be self-leveling and shall be free of shrinkage after hardening. Design the mixture to reach a state of hardening such that it can support foot traffic in no more than 24 hours. Provide a mixture that also meets the following requirements.

TEST	METHOD	VALUE
Flow (inch)	ASTM D-6103	9 min
Compressive	ASTM D-6024	20-40 @ 14 days
Strength (psi)		40-80 @ 28 days
		80-120 @ 90 days

Chemical admixtures to control air content and setting time are allowable. Ten days before placement, furnish the engineer with a design mix detailing all components and their proportions in the mix.

**C Construction**

Place controlled low strength backfill at the locations and to the lines and grades as shown on the plan. Proportion and mix materials to produce a product of consistent texture and flow characteristics. The engineer may reject any materials exhibiting a substantial change in properties, appearance, or composition.

If the official Weather Bureau forecast for the construction site predicts temperatures at or below freezing within the next 24 hours after placement of controlled low strength backfill, protect the placed materials from freezing during that time period. If the temperature is not forecast to rise above 40° F for 72 hours after placement, the engineer may require protection from freezing for up to 72 hours.

No controlled low strength backfill shall be allowed to enter any stream, lake, or sewer system. The contractor shall be responsible for any clean up or remediation costs resulting from such occurrences.

**D Measurement**

The department will measure Backfill Controlled Low Strength in volume by the cubic yard of material, placed and accepted. Such volume shall be computed from actual measurements of the dimensions of the area to be backfilled. In irregular or inaccessible areas, the engineer may allow volume to be determined by other appropriate methods.

**E Payment**

The department will pay for measured quantities at the contract unit price under the following bid item:

ITEM NUMBER	DESCRIPTION	UNIT
209.0200.S	Backfill Controlled Low Strength	CY

Payment is full compensation for designing the mix; supplying all materials; preparing the proportioned mix; hauling it to the construction site; placing the material; and protecting it from freezing.

stp-209-010 (20191121)

**14. Prepare Foundation for CIR Base Layer 7070-06-72, Item 211.0700.S.01.**

**A Description**

This special provision describes the preparation of foundation for work required prior to Cold-In-Place Recycling (CIR) according to standard spec 211 and as hereinafter provided.

**B (Vacant)**

**C Construction**

After any contract required surface milling, and immediately prior to commencing CIR operations, remove from the roadway, and up to one inch below the milled surface, any vegetation, standing water, loose crack filler, and any other deleterious materials.

**D Measurement**

The department will measure Prepare Foundation for CIR Base Layer as each individual project, acceptably completed.

**E Payment**

The department will pay for measured quantities at the contract unit price under the following bid item:

ITEM NUMBER	DESCRIPTION	UNIT
211.0700.S.01.	Prepare Foundation for CIR Base Layer 7070-06-72	EACH

*Replace standard spec 211.5.1 (4) with the following:*

(4) Payment is full compensation for brooming and crack fill removal.

The department will pay separately for the following work associated with yielding areas under this item under the following contract items:

- Base Repair for CIR Layer.

stp-211-020 (20191121)

**15. Base Repair for CIR Layer, Item 211.0800.S.**

**A Description**

This special provision describes base repair for Cold In-Place Recycling (CIR) layer according to standard spec 211, and as hereinafter provided.

**B (Vacant)**

## C Construction

After any contract required surface mill, the engineer and contractor shall visually inspect the milled surface for yielding areas.

Yielding areas will then be repaired prior to the CIR process. The identified yielding areas will be excavated to a maximum of 2 feet, repaired with base course, and a minimum of 5 inches of milled and re-laid pavement material or asphaltic surface in the upper layer.

*Add the following to standard spec 211.3.5:*

Prior to and during the placement of the CIR layer the contractor shall also be responsible for the work covered under this item.

Perform work under this bid item according to standard spec 205.

Remove soft and/or yielding areas of base to a maximum depth of 2-feet. All areas will be documented, and information will be provided to the engineer. If areas are found after paving operation begin, the engineer will be notified of locations. Excavated area will be filled and compacted with material that meets the material requirements of standard spec 305 and Base Aggregate Dense 1 ¼-inch, or standard spec 330 and Mill and Relay, or standard spec 465 and Asphaltic Surface.

Do not exceed plan quantity without written approval from the engineer.

## D Measurement

The department will measure Base Repair for CIR Layer by the cubic yard, acceptably completed.

## E Payment

The department will pay for measured quantities at the contract unit price under the following bid item:

ITEM NUMBER	DESCRIPTION	UNIT
211.0800.S	Base Repair for CIR Layer	CY

Payment is full compensation for removing and excavating areas of base to a maximum of 2 feet; required saw cuts; providing, placing, and compacting dense graded base course; milling and relaying pavement; asphaltic surfacing; and traffic control.

stp-211-030 (20200629)

## 16. Cold In-Place Recycling (CIR) Asphaltic Base Layer, Item 327.1000.S; Asphalt Stabilizing Agent, Item 455.0770.S.

### A Description

- (1) This work consists of the milling, crushing, and screening (as necessary) of the existing hot mix asphalt (HMA) pavement to the width and depth specified on the plans. The processed material shall be blended with foamed asphalt stabilizing agent, water, and other additives as necessary, and required by the mix design, for placement and compaction of this mixture according to the plans and specifications.

### B Materials

#### B.1 Reclaimed Asphalt Pavement (RAP) Material

- (1) The RAP material shall be milled from the existing roadway and processed in place.
- (2) The RAP shall be free of contamination including a base material, aggregate shoulder material, concrete, silt, clay, or other deleterious materials unless specified in the plan.
- (3) Rubberized crack filler, pavement markers, loop wires, fabric, or other materials shall be removed as observed from the roadway during the recycling process. Any residual materials shall be appropriately sized and homogenously blended with the RAP. No rubberized crack filler or fabric piece may have a dimension exceeding a length of 4 inches.

- (4) The milled and processed material shall conform to the following gradation:

<u>Sieve Size</u>	<u>Percent Passing</u>
2"	100
1 ½"	98 to 100
1"	95 to 100

## **B.2 Stabilizing Agent**

- (1) The asphalt stabilizing agent used for Cold In-Place Recycling (CIR) Asphalt Base Layer shall be foamed asphalt.

### **B.2.1 Foamed Asphalt**

- (1) Foamed asphalt shall be produced with a performance graded asphalt binder; without polymer modification; according to standard spec 455.
- (2) Asphalt binder performance grade for foamed asphalt shall be PG 46-34 or PG 52-34. Ensure that the material is furnished by a supplier from the [Combined State Binder Group Certified Supplier List](#).
- (3) Asphalt binder shall be sufficiently heated to meet the mix design expansion and half-life criteria; not to exceed 375° F.
- (4) Asphalt binder shall produce asphalt foam with a minimum expansion ratio of 8, and a half-life of no less than 6 seconds.

### **B.2.2 Water**

- (1) Water may be added to the RAP at the milling head and/or in a mixing chamber.
- (2) Water added to the RAP, used for foaming asphalt, shall be free of sediment and deleterious materials.

## **B.3 Mixture Design**

- (1) The contractor shall be responsible for obtaining milled samples and/or cores for the project mix design.
- (2) Core samples shall be obtained at a minimum frequency of 0.5 lane-mile. Cores shall be obtained from the area to be recycled including the shoulder. Samples obtained by coring should be enough to develop the mix design.
- (3) Samples for mix design obtained by milling shall be taken from at least 3 different locations directly from the area to be recycled.
- (4) All samples shall represent the entire depth of the layer to be recycled.
- (5) Develop and submit a material sampling plan for review and approval a minimum of 5 business days prior to obtaining milled and/or cored samples.
- (6) Material sampling prior to receipt of the engineer's notice to proceed shall require submittal and approval of an Application/Permit to Work on Highway Right-of-Way ([DT1812](#)).
- (7) During material sampling operations, contractor insurance shall be as specified in standard spec 107, traffic control requirements shall be as specified in standard spec 107 and 643, and in the contract special provisions.
- (8) Develop and submit a mix design with the optimal asphalt content 10 business days prior to the start of the CIR operation. This will be developed according to AASHTO MP 38-18 and PP 94-18; and additionally, will conform to the requirements listed in B.3.1. Submit mix design using WisDOT's provided CIR mix design template to the engineer and department's Bureau of Technical Services, Materials Management Section, Pavement Unit: [DOTDLTSDBTSPavementUnit@dot.wi.gov](mailto:DOTDLTSDBTSPavementUnit@dot.wi.gov)

**Table B.3.1 – Minimum Mix Design Requirements**

<b>Properties</b>	<b>Test Method</b>	<b>Specification</b>	<b>Criteria</b>
RAP	Gradation of RAP (Sieve Analysis of Aggregates)	AASHTO MP 38-18 and PP 94-18	Fine or Medium Gradation per AASHTO PP 38-18 (Table 1)
	RAP Coating Test	AASHTO T 59	Minimum Good
Foaming	Foamed Asphalt Expansion Ratio	AASHTO MP 38-18 and PP 94-18	Minimum 8.0 Times
	Foamed Asphalt Half-life		Minimum 6.0 Seconds
Mixture Volumetrics	Bulk Specific Gravity of Compacted Samples		Report Only; Ndes=30
	Maximum Theoretical Specific Gravity		Report Only
	% Air Voids in Compacted Dense and Open Bituminous Paving Mixtures	Report Only	
	Tensile Strength (Resistance of Compacted Mixture to Moisture)  Dry, psi  Ratio (TSR)	Minimum 45 Minimum  0.60*	

\*0.70 for mix designs requiring the addition of cement.

- (9) The mix design shall be used for informational purposes.
- (10) The mix design report shall contain the following minimum information:
  1. Gradation of RAP.
  2. Density, maximum specific gravity, air void content, indirect dry tensile strength, indirect wet (conditioned) tensile strength, and tensile strength ratio at each recycling agent content iteration (minimum of 4; inclusive of recommended moisture and stabilizing contents) and at the recommended moisture and stabilizing agent contents.
  3. Recommended water content from the moisture density curve as a percentage of dry RAP.
  4. Optimum stabilizing agent content as a percentage of dry RAP.
  5. PG grading of asphalt binder for foamed asphalt, supplier name and location, and certified test report.
  6. The optimal foaming characteristics of the asphalt stabilizing agent during the mix design process shall be determined at a minimum of using three different percentages of foamed asphalt content, three different temperatures, and water content.
  7. RAP coating test results.
  8. Any additives that may be used.

**B.4 Quality Management Program**

**B.4.1 Quality Control Plan**

- (1) Submit a comprehensive written quality control plan, including random numbers, to the engineer no later than 10 business days before beginning CIR activities. Construct the project as the plan provides.
- (2) Do not change the quality control plan without the engineer’s review and acceptance. Update the plan with changes as they become effective. Provide a current copy of the plan to the engineer and post it in the contractor’s laboratory as changes are adopted. Ensure that the plan provides the following elements:



1. An organizational chart with names, telephone numbers, current certifications and/or titles, and roles and responsibilities of QC personnel.
2. The process used to disseminate QC information and corrective action efforts to the appropriate persons. Include a list of recipients, the communication process that will be used, and action time frames.
3. A list of suppliers for all stabilizing agents.
4. A list of source locations for all water.
5. An outline for resolving a process control problem. Include responsible personnel, required documentation, and appropriate communication steps.
6. Location of the QC laboratory, retained sample storage, and other documentation.
7. A summary of locations or quantities, selected randomly using ASTM Method D3665, to be tested under this provision.

#### **B.4.2 Pre-CIR Construction Meeting**

A minimum of five business days prior to the start of CIR construction, hold a pre-CIR construction meeting at a mutually agreed upon time and location. Attendance at the pre-CIR construction meeting is mandatory for the engineer, quality control manager, project inspection and testing staff, all appropriate contractor personnel involved in the sampling, testing, and quality control including subcontractors, and the engineer or designated representatives.

#### **B.4.3 Personnel**

- (1) Provide HTCP Nuclear Density Technician I or ACT certified technician for the performance of field density and field moisture content testing.
- (2) Provide HTCP Aggregate Technician I or ACT certified technician for material sampling and sieve analysis.
- (3) A Transportation Materials Sampling (TMS) certified technician is allowed for materials sampling.
- (4) If an ACT is performing sampling or testing, a certified technician must coordinate and take responsibility for the work an ACT performs. Have a certified technician ensure that all sampling and testing are performed correctly, analyze test results, and post resulting data. No more than one ACT can work under a single certified technician.

#### **B.4.4 Equipment**

- (1) Furnish the necessary equipment and supplies for performing quality control testing. Ensure that all testing equipment conforms to the equipment specifications applicable to the required testing methods. The engineer may inspect the measuring and testing devices to confirm both calibration and condition. Calibrate all testing equipment according to the CMM and applicable AASHTO and/or ASTM specifications and maintain a calibration record at the laboratory.
- (2) Furnish nuclear gauges from the department's approved product list at:  
<https://wisconsin.gov/Pages/doing-bus/eng-consultants/cnslt-rsrcs/tools/appr-prod/default.aspx>
- (3) Ensure that the nuclear gauge manufacturer or an approved calibration service calibrates the gauge the same calendar year it is used on the project. Retain a copy of the calibration certificate with the gauge.
- (4) Conform to AASHTO T310 and CMM 8.15 for density testing and gauge monitoring methods.

#### **B.4.5 Quality Control (QC) Testing**

- (1) Roadway production lots will be defined as 4000 lane feet. Each roadway production lot will consist of two 2000 lane feet sublots. The contractor will notify the department before sampling.
- (2) Gradation samples shall be taken at a random location at a minimum frequency of one per lot of production. Gradation samples shall be taken as representative of the full recycled depth. Samples may be obtained prior to or after the addition of stabilizing agent depending on the type of CIR equipment used in the project. For each sample report the gradation of the material, as determined according to AASHTO T27, for the Number 4 (4.75mm) sieve and larger.
- (3) Conduct and report density testing at a minimum frequency of three individual random tests per subplot.
- (4) Conduct and report mill depth checks at a random location at a minimum frequency of once per subplot.

- (5) Measure and report stabilizing agent foaming properties (i.e., half-life and expansion ratio) of each new tanker load from the equipment's test nozzle or recycling unit. If the foaming properties do not meet the requirement as specified in B.2.1, take the necessary corrective action by adjusting the temperature of the stabilizing agent and/or foaming water content.
- (6) Report stabilizing agent temperature at a minimum of one per each new tanker load.
- (7) Report stabilizing agent foamed asphalt expansion ratio and half-life at random locations at a minimum frequency of once per subplot.
- (8) Perform startup QC testing (milling depth, stabilizing agent, foaming properties, and stabilizing agent application rate) within the first 500 feet at the beginning of each day of production.
- (9) Conduct and report daily moisture content of the finished CIR layer representing each day's placement. Moisture content shall be based on the average of three random tests, from each day's placement. The moisture content shall be determined from a sample retrieved over the full depth of the CIR layer by weighting and drying to a constant weight using an oven at  $230^{\circ}\pm 9^{\circ}\text{F}$ . Engineer-directed tests are an addition to the above three tests representing the day's placement.
- (10) Once the section achieves 2.5% or less in moisture, the section is considered cured and additional moisture tests are not required unless directed by the engineer.
- (11) The contractor shall provide a Daily Inspection Report within 48 hours to the engineer summarizing the following:
  - daily beginning and ending stations
  - applicable mix design
  - stabilizing agent temperature
  - stabilizing agent foaming properties
  - subplot tests (mill depth check, density test, and gradation) locations and values
  - lot roadway sample locations
  - moisture

Any adjustments to the application rate of the stabilizing agent, compaction or foaming water shall be reported as stated in section C.1. Test results (except gradation and moisture) shall be provided to the engineer by the end of the business day.

#### **B.4.6 Department Testing**

##### **B.4.6.1 General**

- (1) The department will conduct quality verification (QV) testing to validate the quality of the product and independent assurance (IA) testing to evaluate the sampling and testing. The department will provide the contractor with a listing of names and telephone numbers of all QV and IA personnel for the project and provide test results to the contractor within five business days after the department obtains the sample.

##### **B.4.6.2 Quality Verification (QV) Testing**

- (1) The department will have a technician, or ACT working under a technician, perform QV sampling and testing. Department verification testing personnel must meet the same certification level requirements specified in B.4.3 for contractor testing personnel for each test result being verified. The department will notify the contractor before sampling.
- (2) The department will conduct random QV tests at the minimum frequency of 10% of the required QC tests. The department will observe the contractor's QC stabilizing agent foaming property test.
- (3) The department's mill depth check, roadway gradation sample, and density test sites, will be at locations independent of the contractor's QC work, collecting one sample at each QV location. The department will split each QV gradation sample, test half for QV, and retain the remaining half for seven calendar days.
- (4) The department will verify the contractor's moisture content values by testing a moisture content split sample at a frequency of at least one per day.
- (5) The department will conduct QV tests in a separate laboratory and with separate equipment from the contractor's QC tests. The department will use the same methods specified for QC testing.

- (6) The department will assess QV results by comparing them to the appropriate specification limits. If QV test results conform to this special provision, the department will take no further action. If QV test results are nonconforming, a re-evaluation of the entire process must be completed before production can resume.

#### **B.4.6.3 Independent Assurance (IA)**

- (1) Independence assurance is unbiased testing the department performs to evaluate the department's QV and the contractor's QC sampling and testing, including personnel qualifications, procedures, and equipment. The department will perform an IA review according to the department's independent assurance program. That review may include one or more of the following:
  1. Split sample testing.
  2. Proficiency sample testing.
  3. Witnessing sampling and testing.
  4. Test equipment calibration checks.
  5. Requesting that testing personnel perform additional sampling and testing.
- (2) If the department identifies a deficiency, and after further investigation confirms it, correct that deficiency. If the contractor does not correct or fails to cooperate in resolving identified deficiencies, the engineer may suspend placement until action is taken. Resolve disputes as specified in B.4.6.4.

#### **B.4.6.4 Dispute Resolution**

- (1) The engineer and contractor should make every effort to avoid conflict. If a dispute between some aspect of the contractor's and the engineer's testing program does occur, seek a solution mutually agreeable to the project personnel. The department and contractor shall review the data, examine data reduction and analysis methods, evaluate sampling and testing methods/procedures, and perform additional testing. Use ASTM E 178 to evaluate potential statistically outlying data.
- (2) Production test results, and results from other process control testing, may be considered when resolving a dispute.
- (3) If project personnel cannot resolve a dispute, and the dispute affects payment or could result in incorporating non-conforming product or work, the department will use third-party testing to resolve the dispute. The department's central office laboratory, or a mutually agreed on independent testing laboratory, will provide this testing. The engineer and contractor will abide by the results of the third-party tests. The party in error will pay service charges incurred for testing by an independent laboratory. The department may use third-party test results to evaluate the quality of questionable materials and determine the appropriate payment. The department may reject material or otherwise determine the final disposition of nonconforming material as specified in standard spec 106.5.

### **C Construction**

#### **C.1 General**

- (1) Unless the contract provides otherwise, keep the road open to traffic during construction.
- (2) Perform CIR operations; only between the dates of May 15 and September 15; when the air temperature approximately 3 feet above grade, in the shade, and away from artificial heat sources is above 50°F and when the nighttime ambient air temperature is above 35°F the night prior and the following night, unless approved otherwise by the engineer.
- (3) Do not perform CIR operations during inclement weather such as rain or fog; that will not allow proper mixing, placing, and/or compacting of the mixture.
- (4) CIR operations and recycled pavement base layer curing shall be completed to allow adequate time for placement of surfacing according to calendar requirements of standard spec 450.3.2.1.
- (5) The asphalt binder stabilizing agent application rate will be 2.00 percent with a field adjustment tolerance of +/- 0.30 percent. Any changes within the +/- 0.30 percent tolerance from the 2.00 percent application rate will need to be documented with date, time, pavement temperature, location, reason, and new values and communicated to the engineer at the time the change occurs.
- (6) The metered water added at the mill used for cooling and compaction shall be 2.00 percent. Any changes within the +/- 0.30 percent tolerance from the 2.00 percent application rate will need to be documented with date, time, pavement temperature, location, reason, and new values and communicated to the engineer at the time the change occurs.

- (7) If the stabilizing agent or water application rate from the mix design referenced in section B.3 is not within the range of 1.70 to 2.30 percent, at the department's direction, 500 feet test sections will be required as a comparison. The contractor's liability for the department's directed test sections will be waived. The department's Bureau of Technical Services Pavement Unit will be consulted on these test sections. No test section will be considered below 1.50 percent asphalt binder stabilizing agent.

## **C.2 Equipment**

- (1) Equipment used for CIR shall be subject to approval by the engineer.
- (2) Tankers supplying hot stabilizing agent components shall be equipped to constantly monitor temperature within the tank.

### **C.2.1 Milling Machine**

- (1) The primary milling machines; not inclusive of pre-mill/wedge-cut milling units; shall be capable of milling the existing pavement at a minimum width of not less than 12.5 feet and to the depth shown on the plans, specified in the contract or directed by the engineer. A smaller milling machine may be used to mill paved shoulders and miscellaneous areas to increase the recycle width.
- (2) The milling machines shall be equipped with automatic depth control, shall maintain constant cutting depth and width, uniform grade, and uniform slope.
- (3) For processes not incorporating additional screening, sizing, or crushing; the milling machine shall be capable of producing RAP sized as specified in B.1.
- (4) Use of a heating device to soften the pavement is not permitted.

### **C.2.2 Screening, Crushing, and Sizing Equipment**

- (1) Processes requiring additional screening, sizing, or crushing, shall include a unit with a closed-circuit system capable of continuously returning oversized material to the crusher until all milled material entering the screening, crushing, or sizing equipment meets the gradation requirements of section B.1.

### **C.2.3 Mixing Unit**

- (1) Processed RAP shall be mixed with the stabilizing agent and water in a mixing unit; defined as the milling machine cutter housing, a separate mixing chamber, or a pugmill.
- (2) The asphalt stabilizing agent shall be applied; using a computer-controlled additive system; uniformly at the predetermined application rate. The metering of the stabilizing agent must be monitored through a calibrated pump providing a continuous readout of quantities.
- (3) The additive system shall contain separate pumping systems for adding stabilizing agent and water. Each system shall have an inspection or test nozzle for stabilizing agent and/or water sampling.
- (4) The system shall be capable of producing a uniformly mixed homogeneous recycled pavement base layer mixture.

### **C.2.4 Paving Equipment**

- (1) The placement and shaping of the recycled pavement base layer mixture shall be completed using a self-propelled paver or screed integral to the recycling equipment meeting the requirements of standard spec 450.3.1.4; revised to exclude the requirement of an activated screed or strike-off assembly.
- (2) The screed shall not be heated.
- (3) If utilizing a self-propelled paver, the material shall be transferred directly into the paver hopper from the recycling equipment or with a pick-up device. When a pick-up device is used, the entire windrow shall be removed from the milled surface and transferred to the paver hopper.

### **C.2.5 Compaction Equipment**

- (1) Compaction equipment shall be self-propelled and meet the requirements of standard spec 450.3.1.5.
- (2) The number, weight, and types of rollers shall be used as necessary to achieve the specified compaction. At a minimum, the following rollers shall be used:
  1. At least one self-propelled double drum vibratory steel roller with a minimum weight of not less than 10 tons.
  2. At least one self-propelled pneumatic-tired roller with a minimum weight of not less than 22 tons.

### **C.3 Constructing CIR**

#### **C.3.1 Preparation**

- (1) After any contract required surface milling, and immediately prior to commencing CIR operations, remove from the roadway, and up to 1 inch below the milled surface, any vegetation, standing water, loose crack filler, and any other deleterious materials.
- (2) Inspect the pavement surface, after any contract required surface milling, for areas of yielding subgrade. Yielding areas will be repaired prior to CIR operations.
- (3) Blade the existing base aggregate roadway shoulders away from the asphaltic surface edge to minimize contamination of the CIR base layer.

#### **C.3.2 Processing and Placement of CIR Material**

- (1) Mill the existing pavement to the required depth and width indicated on the plans.
- (2) Further process the milled RAP material as necessary by crushing, screening, and/or sizing to the gradation requirements of B.1.
- (3) Blend the RAP material with the mix design specified proportions of stabilizing agent and water; produce a uniform and homogeneous recycled mixture.
- (4) Spread the recycled mixture to the grade, elevations, and slopes specified on the plans, avoiding tearing or scarring of the recycled pavement base layer surface.
- (5) Ensure proper material transfer, handling, and spreading to prevent material segregation. If segregation does occur behind the paver, the contractor shall take immediate steps to correct the problem. Corrective action may include adjusting the forward speed of the paving operation and adjusting the flow of material to paver. The contractor shall make adjustments until a satisfactory end-product has been obtained, as determined by the engineer.
- (6) Longitudinal joints between successive CIR operations shall be overlapped a minimum of 3 inches. Consideration should be given to the amount of stabilizing agent used in the overlapping pass. Adjust the width of the stabilizing agent application so that the overlapped CIR mixtures maintains the target stabilizing agent content. Transverse joints between successive CIR operations during the same day of placement shall be overlapped a minimum of 2 feet. The beginning of each day's recycling operation shall overlap the end of the preceding recycling operation a minimum of 50 feet unless otherwise directed by the engineer.

### **C.4 Compaction**

#### **C.4.1 Control Strip Construction**

- (1) On the first day of production, construct a control strip to identify the target wet density for the CIR layer using a nuclear moisture-density gauge in backscatter measurement. Nuclear gauge test duration in backscatter measurement shall be for a total of one-minute test per location in the direction of paving. The control strip construction and density testing will occur under the direct observation and/or assistance of the department QV personnel.
- (2) After the construction of the control strip, the CIR process shall be permitted to continue until the project's first asphalt binder tanker truck is empty. Any further CIR process shall be halted till the completion of the test rolling.
- (3) Unless the engineer approves otherwise, construct control strips to a minimum dimension of 500 feet long and one full lane width. Begin the control strip at a location of at least 200 feet beyond the start of the project.
- (4) Completed control strips may remain in-place to be incorporated into the final roadway cross-section.
- (5) Construct additional control strips, at a minimum, when:
  1. The CIR layer thickness changes in excess of 2.0 inches.
  2. The percent of target wet density is less than 96% or exceeds 105.0%; and is outside the range of the 10 random measurements defining the control strip; on two consecutive sublots.
  3. If there is a significant change in mix proportions, weather conditions, compaction equipment, or other controlling factors, the engineer may require the construction of new control strips to check target density.

- (6) Construct control strips using equipment and methods representative of the operations to be used for constructing the CIR layer.
- (7) After compacting the control strip with a minimum of three roller passes, mark and take three wet density measurements using a nuclear moisture-density gauge in backscatter mode at one random station. One density measurement representing the inside 1/3, one density measurement representing the middle 1/3, and one density measurement representing the outside 1/3 transversely across the traveled lane, a minimum of 1 ½ feet from the center of the probe to the unrestricted edge of the CIR layer. Subsequent density measurements will be taken at the same three locations.
- (8) After each subsequent pass of compaction equipment over the entirety of the control strip, take wet density measurements at the three marked locations. Continue compacting and testing until the increase in density measurements of individual locations is less than 2.0 lb/ft<sup>3</sup>, or the density measurements begin to decrease.
- (9) Upon completion of control strip compaction, take 10 randomly located wet density measurements within the limits of the control strip, a minimum of 1 ½ feet from the center of the probe to the unrestricted edge of the CIR layer. The final measurements recorded at the three locations under article paragraph (6) of this section may be included as 3 of the 10 measurements. Average the 10 measurements to obtain the control strip target density.

#### **C.4.2 Compaction Requirements**

- (1) Compact the CIR layer to a required density of 96% of the target density. Density acceptance shall be based on the average subplot measurements results.

#### **C.5 Surface Requirements**

- (1) Prior to placement of the surface treatment, the engineer and contractor shall visually inspect the CIR layer for distresses including, but not limited to raveled areas, rutted areas, and areas of excess or deficient stabilizing agent, or deficient surface tolerance areas.
- (2) Test the recycled pavement base layer surface at regular intervals, and engineer selected locations, using a 10-foot straightedge or other engineer-specified devices.
- (3) The engineer may direct the repair of surface deviations greater than ½ inch between two surface contact points. High points shall be corrected by rerolling, trimming, milling, or grinding. Depressions may be corrected by having a tack coat applied and be filled with HMA immediately prior to placement of the surface treatment.
- (4) Raveled areas, rutted areas, and areas of excess or deficient stabilizing agent shall be re-processed or repaired. Reprocessing shall consist of milling, blending of additional stabilizing agent, placement with a paver, and compaction with determined rolling patterns as determined by the control strip.

#### **C.6 Maintaining the Work**

- (1) After compaction is complete, the contractor will determine when the CIR is stable to open to traffic.
- (2) After opening to traffic, and prior to placement of the upper layer, the surface of the recycled base shall be maintained in a condition suitable for the safe movement of traffic.
- (3) The recycled base and shoulders shall be protected and maintained from standing water, deleterious substances, and/or other damage.
- (4) Any damage to the recycled base, excluding department-directed test sections, shall be repaired by the contractor prior to placement of the upper layer at no additional cost to the department.

#### **C.7 Curing and Surfacing**

##### **C.7.1 Curing**

- (1) Application of a surface treatment or leveling/lower layer of HMA will not be allowed until the moisture content of the CIR layer reduces to 2.50 percent or less.
- (2) If the moisture content of the CIR layer does not reduce to 2.50 percent; the surface treatment may be applied after the change in moisture content is less than 0.30 percentage points for three consecutive calendar days

- (3) The moisture content shall be determined from a sample retrieved over the full depth of the CIR layer by weighting and drying to a constant weight using an oven at 230°±9°F. Moisture content testing by nuclear density shall only be used for informational purposes and not for acceptance. The department will obtain a sample(s) to verify the contractor's final moisture content values.

**C.7.2 Tack Coat**

- (1) The surface shall be prepared, and tack coat applied meeting the requirements of standard spec 455.3.2.
- (2) Tack coat application rate shall be 0.05 to 0.07 gal/SY. The engineer may adjust the tack coat application rate based on surface conditions.
- (3) Use only emulsified asphalt material as tack coat specified in standard spec 455.2.5. Paving grade asphaltic tack coat shall not be used.

**C.7.3 Surfacing**

- (1) Surfacing materials, equipment, and construction methods shall be according to the applicable sections of the standard specs or contract special provisions.
- (2) Paving of final surfacing (for single layer) or leveling/lower layer of HMA on the cured CIR sections shall not be conducted until the moisture content in the CIR layer reduces to 2.50% or less.
- (3) The final surfacing (for single layer) or leveling/lower layer shall be placed on the CIR layer within 10 calendar days once a section of the CIR layer is considered cured per section B.4.5.
- (4) After any rain event, the excess moisture in the CIR layer shall be allowed to dry before paving the final surfacing (for single layer) or leveling/lower HMA layer. The contractor and engineer should inspect the CIR layer to determine suitability for surfacing.

**D Measurement**

- (1) The department will measure Cold In-Place Recycling (CIR) Asphaltic Base Layer by the square yard, acceptably completed.
- (2) The department will measure the Asphalt Stabilizing Agent incorporated into the work by the ton; as metered through a calibrated pump, or through delivered ticket quantity.

**E Payment**

- (1) The department will pay for measured quantities at the contract unit price under the following bid item:
 

ITEM NUMBER	DESCRIPTION	UNIT
327.1000.S	Cold In-Place Recycling (CIR) Asphaltic Base Layer	SY
455.0770.S	Asphalt Stabilizing Agent	TON
- (2) Payment is full compensation for measured quantities as specified above; all material including mixing and milling water; equipment necessary for milling and sizing, mixing, paving, compacting the completed CIR; incidentals necessary to the conduct mix design; including sampling and traffic control; mill the existing pavement for recycling, size the milled RAP, inject and mix the RAP with the stabilizing agent, place or pave, compact, and maintain the completed CIR.
- (3) The department will pay separately for the repair of yielding areas under the bid item Base Repair for CIR Layer.
- (4) The department will pay separately for removing or blading away of the adjacent shoulder material under the bid item Shaping Shoulders.
- (5) The department will pay separately for preparation under the bid item Prepare Foundation for CIR Base Layer.
- (6) The department will pay separately for surfacing treatments, including tack coat, under the appropriate bid items.

stp-327-010 (20230629)

**17. HMA Percent Within Limits (PWL) Test Strip Volumetrics, Item 460.0105.S;  
HMA Percent Within Limits (PWL) Test Strip Density, Item 460.0110.S.**

**A Description**

This special provision describes the Hot Mix Asphalt (HMA) density and volumetric testing tolerances required for an HMA test strip. An HMA test strip is required for contracts constructed under HMA Percent Within Limits (PWL) QMP. A density test strip is required for each pavement layer placed over a specific, uniform underlying material, unless specified otherwise in the plans. Each contract is restricted to a single mix design per mix type per layer (e.g., upper layer and lower layer may have different mix type specified or may have the same mix type with different mix designs). Each mix design requires a separate test strip. Density and volumetrics testing will be conducted on the same test strip whenever possible.

Perform work according to standard spec 460 and as follows.

**B Materials**

Use materials conforming to HMA Pavement Percent Within Limits (PWL) QMP special provision.

**C Construction**

**C.1 Test Strip**

Submit the test strip start time and date to the department in writing at least 5 calendar days in advance of construction of the test strip. If the contractor fails to begin paving within 2 hours of the submitted start time, the test strip is delayed, and the department will assess the contractor \$2,000 for each instance according to Section E of this document. Alterations to the start time and date must be submitted to the department in writing a minimum of 24 hours prior to the start time. The contractor will not be liable for changes in start time related to adverse weather days as defined by standard spec 101.3 or equipment breakdown verified by the department.

On the first day of production for a test strip, produce approximately 750 tons of HMA. (Note: adjust tonnage to accommodate natural break points in the project.) Locate test strips in a section of the roadway to allow a representative rolling pattern (i.e. not a ramp or shoulder, etc.).

**C.1.1 Sampling and Testing Intervals**

**C.1.1.1 Volumetrics**

Laboratory testing will be conducted from a split sample yielding three components, with portions designated for QC (quality control), QV (quality verification), and retained.

During production for the test strip, obtain sufficient HMA mixture for three-part split samples from trucks prior to departure from the plant. Collect three split samples during the production of test strip material. Perform sampling from the truck box and three-part splitting of HMA according to WTM R47. These three samples will be randomly selected by the engineer from each *third* of the test strip tonnage (T), excluding the first 50 tons:

<u>Sample Number</u>	<u>Production Interval (tons)</u>
1	50 to 1/3 T
2	1/3 T to 2/3 T
3	2/3 T to T

**C.1.1.2 Density**

Required field tests include contractor QC and department QV nuclear density gauge tests and pavement coring at ten individual locations (five in each half of the test strip length) according to Appendix A: *Test Methods and Sampling for HMA PWL QMP Projects*. Both QV and QC teams shall have two nuclear density gauges present for correlation at the time the test strip is constructed. QC and QV teams may wish to scan with additional gauges at the locations detailed in Appendix A, as only gauges used during the test strip correlation phase will be allowed.



## **C.1.2 Field Tests**

### **C.1.2.1 Density**

For contracts that include STSP 460-020 QMP Density in addition to PWL, a gauge comparison according to WTM T355 shall be completed prior to the day of test strip construction. Daily standardization of gauges on reference blocks and a project reference site shall be performed according to WTM T355. A standard count shall be performed for each gauge on the material placed for the test strip, prior to any additional data collection. Nuclear gauge readings and pavement cores shall be used to determine nuclear gauge correlation according to Appendix A. The two to three readings for the five locations across the mat for each of two zones shall be provided to the engineer. The engineer will analyze the readings of each gauge relative to the densities of the cores taken at each location. The engineer will determine the average difference between the nuclear gauge density readings and the measured core densities to be used as a constant offset value. This offset will be used to adjust raw density readings of the specific gauge and shall appear on the density data sheet along with gauge and project identification. An offset is specific to the mix and layer; therefore, a separate value shall be determined for each layer of each mix placed over a differing underlying material for the contract. This constitutes correlation of that individual gauge for the given layer. Two gauges per team are not required to be onsite daily after completion of the test strip. Any data collected without a correlated gauge will not be accepted.

The contractor is responsible for coring the pavement from the footprint of the density tests and filling core holes according to Appendix A. Coring and filling of pavement core holes must be approved by the engineer. The QV team is responsible for the labeling and safe transport of the cores from the field to the QC laboratory. Testing of cores shall be conducted by the contractor and witnessed by department personnel. The contractor is responsible for drying the cores following testing. The department will take possession of cores following laboratory testing and will be responsible for any verification testing at the discretion of the engineer.

The target maximum density to be used in determining core density is the average of the three volumetric/mix Gmm values from the test strip multiplied by 62.24 lb/ft<sup>3</sup>. In the event mix and density portions of the test strip procedure are separated, or if an additional density test strip is required, the mix portion must be conducted prior to density determination. The target maximum density to determine core densities shall then be the Gmm four-test running average (or three-test average from a PWL volumetric-only test strip) from the end of the previous day's production multiplied by 62.24 lb/ft<sup>3</sup>. If no PWL production QV volumetric test is to be taken in a density-only test strip, a non-random QV test will be taken according to 460.2.8.3.1.4 as modified in HMA Pavement Percent Within Limits (PWL) QMP and if non-conforming to C.2.1 herein, follow corrective action outlined in 460.2.8.2.1.7(4) as modified in HMA Pavement Percent Within Limits (PWL) QMP.

Exclusions such as shoulders and appurtenances shall be tested and reported according to CMM 815. However, all acceptance testing of shoulders and appurtenances will be conducted by the department, and average lot (daily) densities must conform to standard spec Table 460-3. No density incentive or disincentive will be applied to shoulders or appurtenances. However, unacceptable shoulder material will be handled according to standard spec 460.3.3.1 and CMM 815.11.

### **C.1.3 Laboratory Tests**

#### **C.1.3.1 Volumetrics**

Obtain random samples according to C.1.1.1 and Appendix A. Perform tests the same day as taking the sample.

Theoretical maximum specific gravities of each mixture sample will be obtained. Bulk specific gravities of both gyratory compacted samples and field cores shall be determined. The bulk specific gravity values determined from field cores shall be used to calculate a correction factor (i.e., offset) for each QC and QV nuclear density gauge. The correction factor will be used throughout the remainder of the layer.

## C.2 Acceptance

### C.2.1 Volumetrics

Produce mix conforming to the following limits based on individual QC and QV test results (tolerances based on most recent JMF):

ITEM	ACCEPTANCE LIMITS
Percent passing given sieve:	
37.5-mm	+/- 8.0
25.0-mm	+/- 8.0
19.0-mm	+/- 7.5
12.5-mm	+/- 7.5
9.5-mm	+/- 7.5
2.36-mm	+/- 7.0
75-µm	+/- 3.0
Asphaltic content in percent <sup>[1]</sup>	- 0.5
Air Voids	-1.5 & +2.0
VMA in percent <sup>[2]</sup>	- 1.0
Maximum specific gravity	+/- 0.024

<sup>[1]</sup> Asphalt content more than -0.5% below the JMF will be referee tested by the department's AASHTO accredited laboratory and HTCP certified personnel using automated extraction.

<sup>[2]</sup> VMA limits based on minimum requirement for mix design nominal maximum aggregate size in [table 460-1](#).

QV samples will be tested for Gmm, Gmb, and AC. Air voids and VMA will then be calculated using these test results.

Calculation of air voids shall use either the QC, QV, or retained split sample test results, as identified by conducting the paired t-test with the WisDOT PWL Test Strip Spreadsheet.

If QC and QV test results do not correlate as determined by the split sample comparison, the retained split sample will be tested by the department's AASHTO accredited laboratory and HTCP certified personnel as a referee test. Additional investigation shall be conducted to identify the source of the difference between QC and QV data. Referee data will be used to determine material conformance and pay.

### C.2.2 Density

Compact all layers of test strip HMA mixture according to Table 460-3.

Nuclear density gauges are acceptable for use on the project only if correlation is completed for that gauge during the time of the test strip and the department issues documentation of acceptance stating the correlation offset value specific to the gauge and mix design. The offset is not to be entered into any nuclear density gauge as it will be applied by the department-furnished Field Density Worksheet.

### C.2.3 Test Strip Approval and Material Conformance

All applicable laboratory and field testing associated with a test strip shall be completed prior to any additional mainline placement of the mix. All test reports shall be submitted to the department upon completion and approved before paving resumes. The department will notify the contractor within 24 hours from start of test strip regarding approval to proceed with paving unless an alternate time frame is agreed upon in writing with the department. The 24-hour approval time includes only working days as defined in standard spec 101.3.

The department will evaluate material conformance and make pay adjustments based on the PWL value of air voids and density for the test strip. The QC core densities and QC and QV mix results will be used to determine the PWL values as calculated according to Appendix A.

The PWL values for air voids and density shall be calculated after determining core densities. An approved test strip is defined as the individual PWL values for air voids and density both being equal to or greater than 75, mixture volumetric properties conforming to the limits specified in C.2.1, and an acceptable gauge-to-core correlation. Further clarification on PWL test strip approval and appropriate post-test strip actions are shown in the following table:

PWL TEST STRIP APPROVAL AND MATERIAL CONFORMANCE CRITERIA

PWL VALUE FOR AIR VOIDS AND DENSITY	TEST STRIP APPROVAL	MATERIAL CONFORMANCE	POST-TEST STRIP ACTION
Both PWL $\geq$ 75	Approved <sup>1</sup>	Material paid for according to Section E	Proceed with Production
50 $\leq$ Either PWL < 75	Not Approved	Material paid for according to Section E	Consult BTS to determine need for additional test strip
Either PWL < 50	Not Approved	Unacceptable material removed and replaced or paid for at 50% of the contract unit price according to Section E	Construct additional Volumetrics or Density test strip as necessary

<sup>1</sup> In addition to these PWL criteria, mixture volumetric properties must conform to the limits specified in C.2.1, split sample comparison must have a passing result and an acceptable gauge-to-core correlation must be completed.

A maximum of two test strips will be allowed to remain in place per pavement layer per contract. If material is removed, a new test strip shall replace the previous one at no additional cost to the department. If the contractor changes the mix design for a given mix type during a contract, no additional compensation will be paid by the department for the required additional test strip and the department will assess the contractor \$2,000 for the additional test strip according to Section E of this special provision. For simultaneously conducted density and volumetric test strip components, the following must be achieved:

- i. Passing/Resolution of Split Sample Comparison
- ii. Volumetrics/mix PWL value  $\geq$  75
- iii. Density PWL value  $\geq$  75
- iv. Acceptable correlation

If not conducted simultaneously, the mix portion of a test strip must accomplish (i) and (ii), while density must accomplish (iii) and (iv). If any applicable criteria are not achieved for a given test strip, the engineer, with authorization from the department's Bureau of Technical Services, will direct an additional test strip (or alternate plan approved by the department) be conducted to prove the criteria can be met prior to additional paving of that mix. For a density-only test strip, determination of mix conformance will be according to main production, i.e., HMA Pavement Percent Within Limits (PWL) QMP special provision.

#### D Measurement

The department will measure HMA Percent Within Limits (PWL) Test Strip as each unit of work, acceptably completed as passing the required air void, VMA, asphalt content, gradation, and density correlation for a Test Strip. Material quantities shall be determined according to standard spec 450.4 and detailed here within.

#### E Payment

The department will pay for measured quantities at the contract unit price under the following bid item:

ITEM NUMBER	DESCRIPTION	UNIT
460.0105.S	HMA Percent Within Limits (PWL) Test Strip Volumetrics	EACH
460.0110.S	HMA Percent Within Limits (PWL) Test Strip Density	EACH

These items are intended to compensate the contractor for the construction of the test strip for contracts paved under the HMA Pavement Percent Within Limits QMP article.

Payment for HMA Percent Within Limits (PWL) Test Strip Volumetrics is full compensation for volumetric sampling, splitting, and testing, and for the proper labeling, handling, and retention of the split samples.

Payment for HMA Percent Within Limits (PWL) Test Strip Density is full compensation for collecting and measuring of pavement cores, acceptably filling core holes, providing of nuclear gauges and operator(s), and all other work associated with completion of a core-to-gauge correlation, as directed by the engineer.

Acceptable HMA mixture placed on the project as part of a volumetric or density test strip will be compensated by the appropriate HMA Pavement bid item with any applicable pay adjustments. If a test strip is delayed as defined in C.1 of this document, the department will assess the contractor \$2,000 for each instance, under the HMA Delayed Test Strip administrative item. If an additional test strip is required because the initial test strip is not approved by the department or the mix design is changed by the contractor, the department will assess the contractor \$2,000 for each additional test strip (i.e., \$2,000 for each individual volumetrics or density test strip) under the HMA Additional Test Strip administrative item.

Pay adjustment will be calculated using 65 dollars per ton of HMA pavement. The department will pay for measured quantities of mix based on \$65/ton multiplied by the following pay adjustment:

<b>PAY ADJUSTMENT FOR HMA PAVEMENT AIR VOIDS &amp; DENSITY</b>	
<i>PERCENT WITHIN LIMITS</i>	<i>PAYMENT FACTOR, PF</i>
<i>(PWL)</i>	<i>(percent of \$65/ton)</i>
≥ 90 to 100	PF = ((PWL – 90) * 0.4) + 100
≥ 50 to < 90	(PWL * 0.5) + 55
<50	50% <sup>[1]</sup>

where, PF is calculated per air voids and density, denoted PF<sub>air voids</sub> and PF<sub>density</sub>

<sup>[1]</sup> Material resulting in PWL value less than 50 shall be removed and replaced, unless the engineer allows for such material to remain in place. In the event the material remains in place, it will be paid at 50% of the contract unit price of HMA pavement.

For air voids, PWL values will be calculated using lower and upper specification limits of 2.0 and 4.3 percent, respectively. Lower specification limits for density will be according to Table 460-3. Pay adjustment will be determined for an acceptably completed test strip and will be computed as shown in the following equation:

$$\text{Pay Adjustment} = (\text{PF}-100)/100 \times (\text{WP}) \times (\text{tonnage}) \times (\$65/\text{ton})^*$$

\*Note: If Pay Factor = 50, the contract unit price will be used in lieu of \$65/ton and the weighted percentage (WP) will equal 1.0.

The following weighted percentage (WP) values will be used for the corresponding parameter:

<u>Parameter</u>	<u>WP</u>
Air Voids	0.5
Density	0.5

Individual Pay Factors for each air voids (PF<sub>air voids</sub>) and density (PF<sub>density</sub>) will be determined. PF<sub>air voids</sub> will be multiplied by the total tonnage produced (i.e., from truck tickets), and PF<sub>density</sub> will be multiplied by the calculated tonnage used to pave the mainline only (i.e., traffic lane excluding shoulder) as determined according to Appendix A.

The department will pay incentive for air voids under the following bid item:

ITEM NUMBER	DESCRIPTION	UNIT
SPV.0055.01	Incentive Density PWL HMA Pavement	DOL
SPV.0055.02	Incentive Air Voids HMA Pavement	DOL

The department will administer disincentives under the Disincentive Density HMA Pavement and the Disincentive Air Voids HMA Pavement administrative items.

## 18. **Cleaning Decks to Reapply Concrete Masonry Overlay, Item 509.0505.S.**

### **A Description**

This special provision describes cleaning the entire bridge deck after the existing concrete masonry overlay is removed, prior to placing a new concrete masonry overlay.

**B (Vacant)**

**C Construction**

Blast-clean the entire surface of the deck, the vertical faces of curbs, sidewalks and parapets to the depth of the adjoining concrete overlay. Blast-clean all exposed existing reinforcing steel. Repair damage to existing epoxy-coated reinforcement remaining in place that is either uncovered by or damaged by the contractor's operations. Use engineer-approved patching or repair material compatible with the existing coating and inert in concrete.

Clean the surface on which the new concrete will be placed to remove all loose particles and dust by either brooming and water pressure using a high-pressure nozzle, or by water and air pressure. Use water for cleaning that conforms to standard spec 501.2.6.

**D Measurement**

The department will measure Cleaning Decks to Reapply Concrete Masonry Overlay by the square yard, acceptably completed.

**E Payment**

The department will pay for measured quantities at the contract unit price under the following bid item:

ITEM NUMBER	DESCRIPTION	UNIT
509.0505.S	Cleaning Decks to Reapply Concrete Masonry Overlay	SY

Payment is full compensation for cleaning the concrete surfaces.

stp-509-065 (20210708)

**19. Removing Concrete Masonry Deck Overlay B-9-26, Item 509.9005.S.01.**

**A Description**

This special provision describes removing concrete bridge deck overlays by milling the entire bridge deck as the plans show.

Conform to standard spec 204 as modified in this special provision.

**B (Vacant)**

**C Construction**

**C.1 Milling**

Use a self-propelled milling machine that is specially designed and constructed for milling bridge decks. It shall mill without tearing or gouging the concrete masonry underlying the existing overlay. The machine shall consist of a cutting drum with carbide or diamond tip teeth. Space the teeth on the drum to mill a surface finish that is acceptable to the engineer.

Shroud the machine to prevent discharge of any loosened material into adjacent work areas or live traffic lanes. Equip the machine with electronic devices that provide accurate depth, grade and slope control, and an acceptable dust control system.

Perform milling in a manner that precludes damage to the bridge floor and results in a uniform textured finish that:

1. Is free of sharp protrusions;
2. Removes a minimum of 1/4 inch of the original concrete deck or slab, or to a depth the plans show;
3. Has uniform transverse grooves that measure up to 1/4 inch vertically and transversely; and
4. If applicable, is acceptable to the manufacturer of the sheet waterproof membrane.

Windrowing and storing of the removed milled concrete masonry on the bridge is only permitted in connection with the continuous removal and pick-up operation. During nonworking hours, clear the bridge of all materials and equipment.

**D Measurement**

The department will measure Removing Concrete Masonry Deck Overlay B-9-26 by the square yard, acceptably completed.

**E Payment**

The department will pay for measured quantities at the contract unit price under the following bid item:

ITEM NUMBER	DESCRIPTION	UNIT
509.9005.S.01	Removing Concrete Masonry Deck Overlay B-9-26	SY

Payment is full compensation for removing the concrete masonry; and for properly disposing of all materials.

stp-509-005 (20210113)

**20. Removing Asphaltic Concrete Deck Overlay B-9-26, Item 509.9010.S.01.**

**A Description**

This special provision describes removing asphalt bridge deck overlays with or without a waterproofing membrane by milling the entire bridge deck as the plans show.

Conform to standard spec 204 as modified in this special provision.

**B (Vacant)**

**C Construction**

**C.1 Milling**

Use a self-propelled milling machine that is specially designed and constructed for milling bridge decks. It shall mill without tearing or gouging the concrete masonry underlying the existing overlay. The machine shall consist of a cutting drum with carbide or diamond tip teeth. Space the teeth on the drum to mill a surface finish that is acceptable to the engineer.

Shroud the machine to prevent discharge of any loosened material into adjacent work areas or live traffic lanes. Equip the machine with electronic devices that provide accurate depth, grade and slope control, and an acceptable dust control system.

Perform milling in a manner that precludes damage to the bridge floor and results in a uniform textured finish that:

1. Is free of sharp protrusions;
2. Removes a minimum of 1/4 inch of the original concrete deck or slab, or to a depth the plans show;
3. Has uniform transverse grooves that measure up to 1/4 inch vertically and transversely; and
4. If applicable, is acceptable to the manufacturer of the sheet waterproof membrane.

Windrowing or storing of the removed milled asphaltic concrete on the bridge is only permitted in connection with the continuous removal and pick-up operation. During nonworking hours, clear the bridge of all materials and equipment.

**D Measurement**

The department will measure Removing Asphaltic Concrete Deck Overlay B-9-26 by the square yard, acceptably completed.

**E Payment**

The department will pay for measured quantities at the contract unit price under the following bid item:

ITEM NUMBER	DESCRIPTION	UNIT
509.9010.S.01	Removing Asphaltic Concrete Deck Overlay B-9-26	SY

Payment is full compensation for removing the asphaltic concrete with or without a waterproofing membrane; removing the underlying concrete as the spec or plans show; and for properly disposing of all materials.

stp-509-010 (20210113)

**21. Temporary Marking Line Epoxy 6-Inch, Item 643.3170.**

*Add the following to standard spec 643.3.7:*

Install Temporary Marking Line Epoxy 6-Inch according to the permanent pavement marking standard detail drawing prior to rumble strip installation.

**22. Locating No-Passing Zones, Item 648.0100.**

For this project, the spotting sight distance in areas with a 55 mph posted speed limit is 0.21 miles (1108 feet).

stp-648-005 (20060512)

**23. Partially Grouted Riprap, Item SPV.0035.01.**

**A Description**

This special provision describes constructing partially grouted riprap according to standard spec 606 and the following.

Furnish and place stone riprap, at the locations shown in the Plans, as a protective covering on earth slopes, piers, abutments, walls, or other structures, where the soil is susceptible to erosion. Then partially fill the voids of the riprap with a Portland cement based grout by hose or tremie. The final configuration results in an armor layer that retains approximately 50% of the void space of the original riprap. Place riprap “in the dry”, with no installation of riprap underwater. Place riprap on a filter layer consisting of granular material or geotextile material as specified in the plans or by the engineer.

**B Materials**

*Follow the material requirements of standard spec 606.2 except as modified below.*

Furnish stones that meet the requirements of standard spec 606.2.1, the grade required as specified on the plans, or by the engineer. Only use Light, Medium, or Heavy Riprap for Partially Grouted Riprap.

*Replace the material requirements of standard spec 606.2.2 Riprap Grout with the following:*

The approximate mix design for the grout required for one cubic yard of mix is shown in Table 1 below. The applicable materials specifications are listed next to each material in the grout mix. Contractor Mix design is required before placement of the riprap. Check gradation and quality of the crusher chips and sand whenever new material is brought onto the project.

**Table 1: Approximate Mix Design for Grout (one cubic yard of mix)**

Material	Material Specification	Quantity lbs [kg]
Portland Cement	501.2.4.1	740 to 760 [336 to 345]
Fine aggregate (sand), dry	501.2.7.2	1180 to 1200 [535 to 544]
¼” Crusher chips, dry	No. 4 (ASTM #89)	1180 to 1200 [535 to 544]
Water	501.2.6	420 to 450 [190 to 204]
Air entrainment	501.2.5.2	8 to 12%

**Color Admixture:**

Add a color pigment in a color found in the natural stone riprap used. Provide a single-component, pigmented admixture, factory formulated and packaged in cubic foot dosage increments, not multiple additives and pigments to be dosed separately into the mix. Follow manufacturer’s instructions for all batching, placing, finishing, and curing. Develop color samples by the contractor using the test section specified below.

Quality Assurance Requirements:

The engineer will perform Consistency (Slump) Tests on the grout mix. Perform the slump tests a minimum of 2 times per day or whenever new materials are brought onto the project. Make sure to take grout for the tests from the discharge point (i.e. end of the hose) for proper consistency readings.

Follow ASTM C143 "Standard Test Method for Slump of Hydraulic-Cement Concrete." The target values for the slump (ASTM C143) test are as follows: 6.5 to 7.5 in [16.5 to 19 cm] vertical slump.

**C Construction**

Satisfy the construction requirements of 606.3 except as modified below.

*Replace standard spec 606.3.5 (2) with the following:*

**Test section:**

Before application of the grout on the entire riprap installation, complete a test section, to be observed by the engineer. Make this section the same thickness as the standard riprap section, and have minimum dimensions of 10 feet by 10 feet [3 m by 3 m]. The engineer will visually observe the application of the grout, inspect the final grout configuration in the test section, and approve of the method/application. Once approved, use the same method/application used in the test section for the rest of the riprap installation.

**Grouting Method/Application:**

Table 2 below presents the recommended values for quantity of grouting material as a function of the grade of the riprap. Take care so that the application quantities are not exceeded, as too much grout can create an impermeable layer on the surface of the armor layer or on the filter at the bottom of the riprap. Before placing the grout, wet the riprap so it is clean and will bond to the grout.

**Table 2: Grouting Material Quantities**

Riprap Grade	Application Quantity of Grout ft <sup>3</sup> /yd <sup>2</sup> [ m <sup>3</sup> grout / m <sup>2</sup> riprap]
Light	2.0 – 2.2 [0.7 – 0.8]
Medium	2.7 – 3.2 [1.0 – 1.1]
Heavy	3.4 – 4.1 [1.2 – 1.4]

Dispense grout from a flexible hose or tremie attached to a boom on a concrete pump truck or grout pump. The recommended hose diameter size is 2-3 in [5-7.5 cm]. Optimal grout flow rate is no more than 10 gal/min [0.6 l/s] to allow for a manageable and uniform rate of placement on the riprap slope. Supply grout to the pump truck from a standard concrete mixer truck. Apply the grout by hand using the hose or tremie line-by-line along matrix riprap.

After application of the grout on the riprap, approximately 50% of the original void space in the riprap will be retained. The upper half of the riprap layer should have approximately two-thirds of the voids filled with grout, and the lower half of the riprap layer should have approximately one-third of the voids filled with grout.

**D Measurement**

The department will measure Partially Grouted Riprap by the cubic yard, acceptably completed, based on the surface area and thickness of riprap.

**E Payment**

The department will pay for measured quantities at the contract unit price under the following bid item:

ITEM NUMBER	DESCRIPTION	UNIT
SPV.0035.01	Partially Grouted Riprap	CY

Payment is full compensation for all costs involved, including the riprap, grout, labor, and equipment.



**24. HMA Pavement Percent Within Limits (PWL) QMP, Core Pilot Project;  
Incentive Density PWL HMA Pavement, Item SPV.0055.01;  
Incentive Air Voids HMA Pavement SPV.0055.02.**

**A Description**

This special provision describes percent within limits (PWL) pay determination, providing and maintaining a contractor Quality Control (QC) Program, department Quality Verification (QV) Program, required sampling and testing, dispute resolution, corrective action, pavement density, and payment for HMA pavements. Pay is determined by statistical analysis performed on contractor and department test results conducted according to the Quality Management Program (QMP) as specified in standard spec 460, except as modified below.

**B Materials**

Conform to the requirements of standard specs 450, 455, and 460 except where superseded by this special provision. The department will allow only one mix design for each HMA mixture type per layer required for the contract, unless approved by the engineer. The use of more than one mix design for each HMA pavement layer will require the contractor to construct a new test strip in accordance with HMA Pavement Percent Within Limits (PWL) QMP Test Strip Volumetrics article at no additional cost to the department. The HMA Pavement Percent Within Limits (PWL) QMP Test Strip Density article will not be added to the Core Pilot Projects. The contractor may correlate gauges by taking up to 10 additional cores (non-production) at any location during the project. The department will not correlate any gauges.

*Replace standard spec 460.2.8.2.1.3.1 Contracts with 5000 Tons of Mixture or Greater with the following:*

**460.2.8.2.1.3.1 Contracts under Percent within Limits**

(1) Furnish and maintain a laboratory at the plant site fully equipped for performing contractor QC testing. Have the laboratory on-site and operational before beginning mixture production.

(2) Obtain random samples and perform tests according to this special provision and further defined in Appendix A: *Test Methods & Sampling for HMA PWL QMP Projects*. Obtain HMA mixture samples from trucks at the plant. For the subplot in which a QV sample is collected, discard the QC sample and test a split of the QV sample.

(3) Perform sampling from the truck box and three-part splitting of HMA samples according to WTM R47. Sample size must be adequate to run the appropriate required tests in addition to one set of duplicate tests that may be required for dispute resolution (i.e., retained). This requires sample sizes which yield three splits for all random sampling per subplot. All QC samples shall provide the following: QC, QV, and Retained. The contractor shall take possession and test the QC portions. The department will observe the splitting and take possession of the samples intended for QV testing (i.e., QV portion from each sample) and the Retained portions. Additional sampling details are found in Appendix A. Label samples according to WTM R97. Additional handling instructions for retained samples are found in CMM 836.4 and CMM 836.5.

(4) Use the test methods identified below to perform the following tests at a frequency greater than or equal to that indicated:

- Blended aggregate gradations in accordance with WTM T30
- Asphalt content (AC) in percent.

Determined AC using one of the following methods:

- AC by ignition oven according to WTM T308. If the department is using an ignition oven to determine AC, conform to WTP H-003. If the department is not using an ignition oven to determine AC, IOCFs must still be reverified for any of the reasons listed in WTP H-003 Table 2 and conform to WTP H-003 section 3.
- AC by chemical extraction according to AASHTO T164 Method A or B.
- AC by automated extraction according to WTM D8159.

- Bulk specific gravity (Gmb) of the compacted mixture according to WTM T166.
- Maximum specific gravity (Gmm) according to WTM T209.
- Air voids ( $V_a$ ) by calculation according to WTM T269.
- Voids in Mineral Aggregate (VMA) by calculation according to WTM R35.

(5) Lot size shall consist of 3750 tons with sublots of 750 tons. Test each design mixture at a frequency of 1 test per 750 tons of mixture type produced and placed as part of the contract. Add a random sample for any fraction of 750 tons at the end of production for a specific mixture design. Partial lots with less than three subplot tests will be included into the previous lot for data analysis and pay adjustment. Volumetric lots will include all tonnage of mixture type under specified bid item unless otherwise specified in the plan.

(6) Conduct field tensile strength ratio tests according to AASHTO T283, without freeze-thaw conditioning cycles, on each qualifying mixture in accordance with CMM 836.6.14. Test each full 50,000-ton production increment, or fraction of an increment, after the first 5,000 tons of production. Perform required increment testing in the first week of production of that increment. If field tensile strength ratio values are below the spec limit, notify the engineer. The engineer and contractor will jointly determine a corrective action.

Delete standard spec 460.2.8.2.1.5 and 460.2.8.2.1.6.

Replace standard spec 460.2.8.2.1.7 Corrective Action with the following:

**460.2.8.2.1.7 Corrective Action**

(1) Material must conform to the following action and acceptance limits based on individual QC and QV test results (tolerances relative to the JMF used on the PWL Test Strip):

ITEM	ACTION LIMITS	ACCEPTANCE LIMITS
Percent passing given sieve:		
37.5-mm	+/- 8.0	
25.0-mm	+/- 8.0	
19.0-mm	+/- 7.5	
12.5-mm	+/- 7.5	
9.5-mm	+/- 7.5	
2.36-mm	+/- 7.0	
75- $\mu$ m	+/- 3.0	
AC in percent	-0.3	-0.5
$V_a$		- 1.5 & +2.0
VMA in percent <sup>[1]</sup>	- 0.5	-1.0

<sup>[1]</sup> VMA limits based on minimum requirement for mix design nominal maximum aggregate size in table 460-1.

(2) QV samples will be tested for Gmm, Gmb, and AC. Air voids and VMA will then be calculated using these test results.

(3) Notify the engineer if any individual test result falls outside the action limits, investigate the cause and take corrective action to return to within action limits. If two consecutive test results fall outside the action limits, stop production. Production may not resume until approved by the engineer. Additional QV samples may be collected upon resuming production, at the discretion of the engineer.

(4) For any additional non-random tests outside the random number testing conducted for volumetrics, the data collected will not be entered into PWL calculations. Additional QV tests must meet acceptance limits or be subject to production stop. If the department's non-random test does not conform to the acceptance limits, the retained sample will be tested by the BTS lab. If the BTS results also do not meet the acceptance limits, the material will be considered unacceptable as described in (5) below.

(5) Remove and replace unacceptable material at no additional expense to the department. Unacceptable material is defined as any individual QC or QV tests results outside the acceptance limits or a PWL value < 50. For AC in percent, unacceptable material is defined as any individual QV test result outside of the acceptance limit. The engineer may allow such material to remain in place with a price reduction. The department will pay for such HMA Pavement allowed to remain in place at 50 percent of the contract unit price.

*Replace standard spec 460.2.8.3.1.2 Personnel Requirements with the following:*

#### **460.2.8.3.1.2 Personnel Requirements**

(1) The department will provide at least one HTCP-certified Transportation Materials Sampling (TMS) Technician, to observe QV sampling of HMA mixtures.

(2) Under departmental observation, a contractor TMS technician shall collect and split samples.

(3) A department HTCP-certified Hot Mix Asphalt, Technician I, Production Tester (HMA-IPT) technician will ensure that all sampling is performed correctly and conduct testing, analyze test results, and report resulting data.

(4) The department will make an organizational chart available to the contractor before mixture production begins. The organizational chart will include names, telephone numbers, and current certifications of all QV testing personnel. The department will update the chart with appropriate changes, as they become effective.

*Replace standard spec 460.2.8.3.1.4 Department Verification Testing Requirements with the following:*

#### **460.2.8.3.1.4 Department Verification Testing Requirements**

(1) HTCP-certified department personnel will obtain QV random samples by directly supervising HTCP-certified contractor personnel sampling from trucks at the plant. Sample size must be adequate to run the appropriate required tests in addition to one set of duplicate tests that may be required for dispute resolution (i.e., retained). This requires sample sizes which yield three splits for all random sampling per subplot. All QV samples shall furnish the following: QC, QV, and Retained. The department will observe the splitting and take possession of the samples intended for QV testing (i.e., QV portion from each sample) and the Retained portions. The department will take possession of retained samples accumulated to date each day QV samples are collected. The department will retain samples until surpassing the analysis window of up to 5 lots, as defined in 460.2.8.3.1.7(2) of this special provision. Additional sampling details are found in Appendix A.

(2) The department will verify product quality using the test methods specified here in 460.2.8.3.1.4(3). The department will identify test methods before construction starts and use only those methods during production of that material unless the engineer and contractor mutually agree otherwise.

(3) The department will perform all testing conforming to the following standards:

- Bulk specific gravity (Gmb) of the compacted mixture according to WTM T166.
- Maximum specific gravity (Gmm) according to WTM T209.
- Air voids (Va) by calculation according to WTM T269.
- Voids in Mineral Aggregate (VMA) by calculation according to WTM R35.
- Asphalt Content (AC) in percent determined by ignition oven method according to WTM T308 and conforming to WTP H-003, chemical extraction according to AASHTO T164 Method A or B, or automated extraction according to WTM D8159.

(4) The department will randomly test each design mixture at the minimum frequency of one test for each lot.

*Delete standard spec 460.2.8.3.1.6.*

*Replace standard spec 460.2.8.3.1.7 Dispute Resolution with the following:*

#### **460.2.8.3.1.7 Data Analysis for Volumetrics**

(1) Analysis of test data for pay determination will be contingent upon QC and QV test results. Statistical analysis will be conducted on Gmm and Gmb test results for calculation of Va. If either Gmm or Gmb analysis results in non-comparable data as described in 460.2.8.3.1.7(2), subsequent testing will be performed for both parameters as detailed in the following paragraph.

(2) The engineer, upon completion of the first 3 lots, will compare the variances (F-test) and the means (t-test) of the QV test results with the QC test results. Additional comparisons incorporating the first 3 lots of data will be performed following completion of the 4<sup>th</sup> and 5<sup>th</sup> lots (i.e., lots 1-3, 1-4, and 1-5). A rolling window of 5 lots will be used to conduct F & t comparison for the remainder of the contract (i.e., lots 2-6, then lots 3-7, etc.), reporting comparison results for each individual lot. Analysis will use a set alpha value of 0.025. If the F- and t-tests report comparable data, the QC and QV data sets are determined to be statistically similar and QC data will be used to calculate the Va used in PWL and pay adjustment calculations. If the F- and t-tests result in non-comparable data, proceed to the *dispute resolution* steps found below. Note: if both QC and QV Va PWL result in a pay adjustment of 102% or greater, dispute resolution testing will not be conducted. Dispute resolution via further investigation is as follows:

[1] The Retained portion of the split from the lot in the analysis window with a QV test result furthest from the QV mean (not necessarily the subplot identifying that variances or means do not compare) will be referee tested for Gmm, Gmb, and Asphalt Content by the bureau's AASHTO accredited laboratory and certified personnel. All previous lots within the analysis window are subject to referee testing and regional lab testing as deemed necessary. Referee test results will replace the QV data of the subplot(s).

[2] Statistical analysis will be conducted with referee test results replacing QV results.

- i. If the F- and t-tests indicate variances and means compare, no further testing is required for the lot and QC data will be used for PWL and pay factor/adjustment calculations.
- ii. If the F- and t-tests indicate non-comparable variances or means, the Retained portion of the random QC sample will be tested for Gmm, Gmb, and Asphalt Content by the department's regional lab for the remaining 4 sublots of the lot which the F- and t-tests indicate non-comparable datasets. The department's regional lab and the referee test results will be used for PWL and pay factor/adjustment calculations. Upon the second instance of non-comparable variance or means and for every instance thereafter, the department will assess a pay reduction for the additional testing of the remaining 4 sublots at \$2,000/lot under the HMA Regional Lab Testing administrative item.

[3] The contractor may choose to dispute the regional test results on a lot basis within 7 days after receiving results from the region. In this event, the retained portion of each subplot will be referee tested by the department's AASHTO accredited laboratory and certified personnel. The referee Gmm and Gmb test results will supersede the regional lab results for the disputed lot.

- i. If referee testing results in an increased calculated pay factor, the department will pay for the cost of the additional referee testing.
- ii. If referee testing of a disputed lot results in an equal or lower calculated pay factor, the department will assess a pay reduction for the additional referee testing at \$2,000/lot under the Referee Testing administrative item.

(3) The department will notify the contractor of the referee test results within 3 working days after receipt of the samples by the department's AASHTO accredited laboratory. The intent is to provide referee test results within 7 calendar days from completion of the lot.

(4) The department will determine mixture conformance and acceptability by analyzing referee test results, reviewing mixture data, and inspecting the completed pavement according to the standard spec, this special provision, and accompanying Appendix A.

(5) Unacceptable material (i.e., resulting in a PWL value less than 50 or individual QC or QV test results not meeting the Acceptance Requirements of 460.2.8.2.1.7 as modified herein) will be referee tested by the bureau's AASHTO accredited laboratory and certified personnel and those test results used for analysis. Such material may be subject to remove and replace, at the discretion of the engineer. If the engineer allows the material to remain in place, it will be paid at 50% of the HMA Pavement contract unit price. Replacement or pay adjustment will be conducted on a subplot basis. If an entire PWL subplot is removed and replaced, the test results of the newly placed material will replace the original data for the subplot. Any remove and replace shall be performed at no additional cost to the department. Testing of replaced material must include a minimum of one QV result. [Note: If the removed and replaced material does not result in replacement of original QV data, an additional QV test will be conducted and under such circumstances will be entered into the HMA PWL Production spreadsheet for data analysis and pay determination.] The quantity of material paid at 50% the contract unit price will be deducted from PWL pay adjustments, along with accompanying data of this material.

*Delete standard spec 460.2.8.3.1.8 Corrective Action.*

## **C Construction**

*Replace standard spec 460.3.3.2 Pavement Density Determination with the following:*

### **460.3.3.2 Pavement Density Determination by Cores**

(1) For mainline pavement, determine density with cores. Full width passing lanes, turn lanes, or auxiliary lanes must be 1500 lane feet or greater to be eligible for PWL density. Shoulder and appurtenance density will be by cores and average lot (daily) densities must conform to standard spec Table 460-3 or else be subject to disincentives according to 460.5.2.2(5) herein. No density incentive will be applied to shoulders or appurtenances.

(2) The engineer will determine the target maximum density using department procedures described in WTM T355 and CMM 815. The engineer will determine density as soon as practicable after compaction and before placement of subsequent layers or before opening to traffic.

(3) A lot is defined as 7500 lane feet with sublots of 1500 lane feet (excluding shoulder, even if paved integrally) and placed within a single layer for each location and target maximum density category indicated in table 460-3. A partial quantity less than 750 lane feet will be included with the previous subplot. Partial lots with less than three sublots will be included in the previous lot for data analysis/acceptance and pay, by the engineer.

(4) Under the direct observation of the engineer, cut 100 or 150 mm (4 or 6 inch) diameter cores from the pavement according to WTM R67 at one random location, determined by the engineer, per subplot. Each core will represent the entire length and width of the subplot. Cores will be cut by the next day, except if the next day is not a working day, then they shall be cut within 48 hours after placement. Fill core holes according to WTM R67 section 5.8 and obtain engineer approval before opening to traffic. Prepare cores and determine density according to WTM T166. Dry cores after testing according WTM R79. The department will label cores, transport cores to testing facilities, witness testing, store dried cores, and provide subsequent verification testing.

(5) If a core is damaged at the time of coring, immediately take a replacement core 1 foot ahead of the existing testing location in the direction of traffic at the same offset as the damaged core. If a core is damaged during transport, record it as damaged and notify the engineer immediately.

(6) Do not re-roll compacted mixtures with deficient density test results. Do not operate continuously below the specified minimum density. Stop production, identify the source of the problem, and make corrections to produce work meeting the specification requirements.

*Replace standard spec 460.3.3.3 Waiving Density Testing with Acceptance of Density Data with the following:*

#### **460.3.3.3 Data Analysis for Density**

- (1) As random density locations are paved, the core data will be recorded in the HMA PWL Production Spreadsheet for analysis in chronological order. Each lot will contain core density data from a single HMA mixture type placed over a specific underlying material.
- (2) The department reserves the right to verify the density of any core and the department's result may be used for PWL and pay adjustment calculations, at the discretion of the engineer.
- (3) The department will determine mixture density conformance and acceptability by analyzing test results, reviewing mixture data, and inspecting the completed pavement according to standard spec, this special provision, and accompanying Appendix A.
- (4) Upon the completion of each lot, core data will be used by the department for PWL and pay adjustment calculation.
- (5) Density resulting in a PWL value less than 50 or not meeting the requirements of 460.3.3.1 (any individual density test result falling more than 3.0 percent below the minimum required target maximum density as specified in standard spec Table 460-3) is unacceptable and may be subject to remove and replace at no additional cost to the department, at the discretion of the engineer.
  - i. Replacement may be conducted on a subplot basis. If an entire PWL subplot is removed and replaced, the test results of the newly placed material will replace the original data for the subplot.
  - ii. Testing of replaced material must include a minimum of one QV result. [Note: If the removed and replaced material does not result in replacement of original QV data, an additional QV test must be conducted and under such circumstances will be entered into the data analysis and pay determination.]
  - iii. If the engineer allows such material to remain in place, it will be paid for at 50% of the HMA Pavement contract unit price. The extent of unacceptable material will be addressed as specified in CMM 815.11. The quantity of material paid at 50% the contract unit price will be deducted from PWL pay adjustments, along with accompanying data of this material.
  - iv. Unacceptable material identified by core density will be removed and replaced or paid at 50% of the contract unit price on a subplot basis.

#### **D Measurement**

The department will measure the HMA Pavement bid items acceptably completed by the ton as specified in standard spec 450.4 and as follows in standard spec 460.5 as modified in this special provision.

#### **E Payment**

*Replace standard spec 460.5.2 HMA Pavement with the following:*

#### **460.5.2 HMA Pavement**

##### **460.5.2.1 General**

(1) Payment for HMA Pavement Type LT, MT, and HT mixes is full compensation for providing HMA mixture designs; for preparing foundation; for furnishing, preparing, hauling, mixing, placing, and compacting mixture; for HMA PWL QMP testing and aggregate source testing; for warm mix asphalt additives or processes; for stabilizer, hydrated lime and liquid antistripping agent, if required; and for all materials including asphaltic materials.

(2) If provided for in the plan quantities, the department will pay for a leveling layer, placed to correct irregularities in an existing paved surface before overlaying, under the pertinent paving bid item. Absent a plan quantity, the department will pay for a leveling layer as extra work.

**460.5.2.2 Calculation of Pay Adjustment for HMA Pavement using PWL**

(1) Pay adjustments will be calculated using 65 dollars per ton of HMA pavement. The HMA PWL Production Spreadsheet, including data, will be made available to the contractor by the department as soon as practicable upon completion of each lot. The department will pay for measured quantities of mix based on this price multiplied by the following pay adjustment calculated in accordance with the HMA PWL Production Spreadsheet:

<i>PERCENT WITHIN LIMITS</i>	<i>PAYMENT FACTOR, PF</i>
<i>(PWL)</i>	<i>(percent of \$65/ton)</i>
≥ 90 to 100	PF = ((PWL – 90) * 0.4) + 100
≥ 50 to < 90	(PWL * 0.5) + 55
<50	50% <sup>[1]</sup>

where PF is calculated per air voids and density, denoted PF<sub>air voids</sub> & PF<sub>density</sub>.

<sup>[1]</sup> Any material resulting in PWL value less than 50 shall be removed and replaced unless the engineer allows such material to remain in place. In the event the material remains in place, it will be paid at 50% of the contract unit price of HMA pavement.

(2) For air voids, PWL values will be calculated using lower and upper specification limits of 2.0 and 4.3 percent, respectively. Lower specification limits for density shall be in accordance with standard spec Table 460-3.

(3) Pay adjustment will be determined on a lot basis and will be computed as shown in the following equation.

$$\text{Pay Adjustment} = (\text{PF}-100)/100 \times (\text{WP}) \times (\text{tonnage}) \times (\$65/\text{ton})^*$$

\*Note: If Pay Factor = 50, the contract unit price will be used in lieu of \$65/ton and the weighted percentage (WP) will equal 1.0. The following weighted percentage (WP) values will be used for the corresponding parameter:

<u>Parameter</u>	<u>WP</u>
Air Voids	0.5
Density	0.5

(4) Individual Pay Factors for each air voids (PF<sub>air voids</sub>) and density (PF<sub>density</sub>) will be determined. PF<sub>air voids</sub> will be multiplied by the total tonnage placed (i.e., from truck tickets), and PF<sub>density</sub> will be multiplied by the calculated tonnage used to pave the mainline only (i.e., traffic lanes excluding shoulder) as determined in accordance with Appendix A.

(5) Pay adjustment for shoulders and appurtenances accepted by department testing will be determined on a lot basis. If the lot density is less than the specified minimum in table 460-3, the department will reduce pay based on the contract unit price for the HMA pavement bid item for that lot as follows:

**DISINCENTIVE PAY REDUCTION FOR HMA PAVEMENT DENSITY**

PERCENT LOT DENSITY	PAYMENT FACTOR
BELOW SPECIFIED MINIMUM	(percent of contract price)
From 0.5 to 1.0 inclusive	98
From 1.1 to 1.5 inclusive	95
From 1.6 to 2.0 inclusive	91
From 2.1 to 2.5 inclusive	85
From 2.6 to 3.0 inclusive	70
More than 3.0 <sup>[1]</sup>	—

<sup>[1]</sup> Remove and replace the lot with a mixture at the specified density. When acceptably replaced, the department will pay for the replaced work at the contract unit price. Alternatively, the engineer may allow the nonconforming material to remain in place with a 50 percent payment factor.

(6) The department will pay incentive for air voids and density under the following bid items:

ITEM NUMBER	DESCRIPTION	UNIT
SPV.0055.01	Incentive Density PWL HMA Pavement	DOL
SPV.0055.02	Incentive Air Voids HMA Pavement	DOL

(7) The department will administer disincentives under the Disincentive Density HMA Pavement and the Disincentive Air Voids HMA Pavement administrative items.

(8) The department will administer a disincentive under the Disincentive HMA Binder Content administrative item for each individual QV test result indicating asphalt binder content below the Action Limit in 460.2.8.2.1.7 presented herein. The department will adjust pay per subplot of mix at 65 dollars per ton of HMA pavement multiplied by the following pay adjustment calculated according to the HMA PWL Production Spreadsheet:

<u>AC Binder Relative to JMF</u>	<u>Pay Adjustment / Sublot</u>
-0.4% to -0.5%	75% <sup>[1]</sup>
More than -0.5%	50% <sup>[1][2]</sup>

<sup>[1]</sup> Any material resulting in an asphalt binder content more than 0.3% below the JMF AC content will be referee tested by the department’s AASHTO accredited laboratory and HTCP certified personnel using automated extraction according to automated extraction according to WTM D8159.

<sup>[2]</sup> Any material resulting in an asphalt binder content more than 0.5% below the JMF AC content shall be removed and replaced unless the engineer allows such material to remain in place. In the event the material remains in place, it will be paid at 50% of the contract unit price of HMA pavement.

Note: PWL value determination is further detailed in the *PWL Production Spreadsheet Instructions located in the Project Info and Instructions tab* of the HMA PWL Production spreadsheet.

Revised: 10/16/2023

**25. Appendix A, Core Pilot Project.**

**Test Methods & Sampling for HMA PWL QMP Projects.**

The following procedures are included with the HMA Pavement Percent Within Limits (PWL) Quality Management Program (QMP) special provision:

- WisDOT Test Method for HMA PWL QMP Density Measurements for Main Production
- Sampling for WisDOT HMA PWL QMP
- Calculation of PWL Mainline Tonnage Example



## WisDOT Test Method for HMA PWL QMP Density Determination for Main Production

For mainline density determination, typical subplot lengths are 1500 lane feet and lots typically consist of 5 sublots. Partial lots with less than three sublots remaining at the end of the project will be included in the previous lot, by the engineer. The PWL Density measurements do not include the shoulder and other appurtenances. Such areas are tested by the department and are not eligible for density incentive but are subject to disincentive according to 460.5.2.2(5) of the HMA PWL QMP STSP.

### **Determination by Cores**

For mainline density determination by cores, collect one core per subplot. Each core location is determined by the engineer using random numbers and represents the entire length and width of the subplot. The contractor is responsible for all work related to coring and filling of the core holes according to WTM R67. Each core is tested for density according to WTM T166 by the contractor and witnessed by a department representative. The department must always maintain custody of the cores during collection, transportation, and testing. Figure 5 shows an example coring layout for a 12-foot-wide lane.

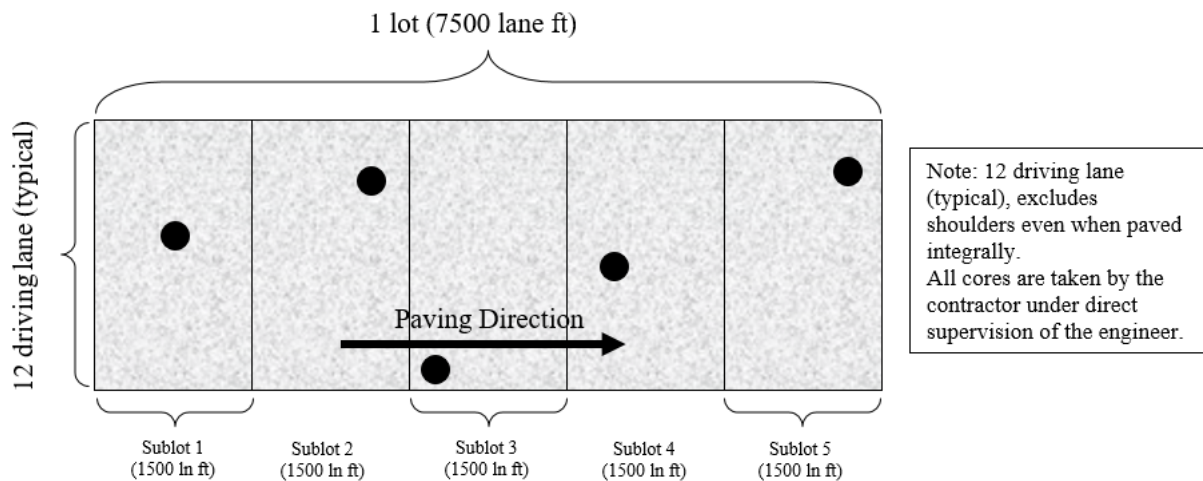

**Figure 5: Example core density locations for traffic lanes**

### Sampling for WisDOT HMA PWL QMP Production

Sampling of HMA mix for QC, QV and Retained samples shall conform to WTM R97 and WTM R47 except as modified here.

### **Sampling Hot Mix Asphalt**

At the beginning of the contract, the contractor determines the anticipated tonnage to be produced. The frequency of sampling is 1 per 750 tons (subplot) for QC and Retained Samples and 1 per 3750 tons (lot or 5 sublots) for QV as defined by the HMA PWL QMP STSP. A test sample is obtained randomly from each subplot. Each random sample shall be collected at the plant according to WTM R97. The contractor must submit the random numbers for all mix sampling to the department before production begins.

*Example 1*

Expected production for a contract is 12,400 tons. The number of required samples is determined based on this expected production (per HMA PWL QMP SPV) and is determined by the random sample calculation.

- Sample 1 – from 50 to 750 tons
- Sample 2 – from 751 to 1500 tons
- Sample 3 – from 1501 to 2250 tons
- Sample 4 – from 2251 to 3000 tons
- Sample X – .....
- Sample 16 – from 11,251 to 12,000 tons
- Sample 17 – from 12,001 to 12,400 tons

The approximate location of each sample within the prescribed sublots is determined by selecting random numbers using WTM D3665. The random numbers selected are used in determining when a sample is to be taken and will be multiplied by the subplot tonnage. This number will then be added to the final tonnage of the previous subplot to yield the approximate cumulative tonnage of when each sample is to be taken.

To allow for plant start-up variability, the procedure calls for the first random sample to be taken at 50 tons or greater per production day (not intended to be taken in the first two truckloads). Random samples calculated for 0-50 ton should be taken in the next truck (51-75 ton).

This procedure is to be used for any number of samples per contract.

If the production is less than the final randomly generated sample tonnage, then the random sample is to be collected from the remaining portion of that subplot of production. If the randomly generated sample is calculated to be within the first 0-50 tons of the subsequent day of production, it should be taken in the next truck. Add a random sample for any fraction of 750 tons at the end of the contract. Lot size will consist of 3750 tons with sublots of 750 tons. Partial lots with less than three subplot tests will be included into the previous lot, by the engineer.

It's intended that the plant operator is not advised ahead of time when samples are to be taken.

If belt samples are used during troubleshooting, the blended aggregate will be obtained when the mixture production tonnage reaches approximately the sample tonnage. For plants with storage silos, this could be up to 60 minutes in advance of the mixture sample that's taken when the required tonnage is shipped from the plant.

QC, QV and retained samples shall be collected for all test strip and production mixture testing using a three-part splitting procedure according to WTM R47.

**Calculation of PWL Mainline Tonnage Example**

A mill and overlay project in being constructed with a 12-foot traffic lane and an integrally paved 3-foot shoulder. The layer thickness is 2 inches for the full width of paving. Calculate the tonnage in each subplot eligible for density incentive or disincentive.

**Solution:**

$$\frac{1500 \text{ ft} \times 12 \text{ ft}}{9 \text{ sf/sy}} \times \frac{2 \text{ in} \times 112 \text{ lb/sy/in}}{2000 \text{ lb/ton}} = 224 \text{ tons}$$

**26. HMA Pavement Longitudinal Joint Density, Core Pilot Project;  
Incentive Density HMA Pavement Longitudinal Joints, Item SPV.0055.03.**

**A Description**

This special provision incorporates longitudinal joint density requirements into the contract and describes the data collection, acceptance, and procedure used for determination of pay adjustments for HMA pavement longitudinal joint density. Pay adjustments will be made on a linear foot basis, as applicable per pavement layer and paving lane. Applicable longitudinal joints are defined as those between any two or more traffic lanes including full-width passing lanes, turn lanes, or auxiliary lanes more than 1500 lane feet, and those lanes must also include the 460.2005 Incentive Density PWL HMA Pavement bid item. This excludes any joint with one side defined as a shoulder and ramp lanes of any length. If echelon paving is required in the contract, the longitudinal joint density specification shall not apply for those joints. Longitudinal joints placed during a test strip will be tested for information only to help ensure the roller pattern will provide adequate longitudinal joint density during production. Longitudinal joint density test results collected during a test strip are not eligible for pay adjustment.

Pay is determined according to standard spec 460, HMA Pavement Percent Within Limits QMP special provisions, and as modified within.

**B Materials**

Compact all applicable HMA longitudinal joints to the appropriate density based on the layer, confinement, and mixture type shown in Table B-1.

**TABLE B-1 MINIMUM REQUIRED LONGITUDINAL JOINT DENSITY**

Layer	Percent of Target Maximum Density			
	Unconfined		Confined	
	LT and MT	HT	LT and MT	HT
Lower (on crushed/recycled base)	88	89	89.5	90.5
Lower (on Concrete/HMA)	90 <sup>[1]</sup>	90 <sup>[1]</sup>	91.5 <sup>[1]</sup>	91.5 <sup>[1]</sup>
Upper	90	90	91.5	91.5

<sup>[1]</sup> Minimum reduced by 1.0 percent for a 1.25-inch-thick No. 5 mix lower layer constructed on a paved or milled surface.

**C Construction**

*Add the following to standard spec 460.3.3.2:*

- (5) Establish companion density locations at each applicable joint. Each companion location shares longitudinal stationing with a QV density location within each subplot and is located transversely with the center of the core 6-inches from the final joint edge of the paving area. Sublot and lot numbering remains the same as mainline densities, however, in addition to conventional naming, joint identification must clearly indicate “M” for inside/median side of lane or “O” for outside shoulder side of lane, as well as “U” for an unconfined joint or “C” for a confined joint (e.g., XXXXX-MC or XXXXX-OU).
- (6) Each joint will be measured, reported, and accepted under methods, testing times, and procedures consistent with the program employed for mainline density, i.e., PWL.
- (7) For single density test results greater than 3.0% below specified minimums per Table B-1 herein, perform the following:
  - a) Testing at 50-foot increments both ahead and behind the unacceptable site
  - b) Continued 50-foot incremental testing until test values indicate higher than or equal to -3.0 percent from target joint density.

- c) Materials within the incremental testing indicating lower than -3.0 percent from target joint density are defined as unacceptable and will be handled with remedial action as defined in the payment section of this document.
- d) The remaining subplot average (exclusive of unacceptable material) will be determined by the first forward and backward 50-foot incremental tests that reach the criteria of higher than or equal to -3.0 percent from target joint density.

Note: If the 50-foot testing extends into a previously accepted subplot, remedial action is required up to and inclusive of such material; however, the results of remedial action must not be used to recalculate the previously accepted subplot density. When this occurs, the lane feet of any unacceptable material will be deducted from the subplot in which it is located, and the previously accepted subplot density will be used to calculate pay for the remainder of the subplot.

- (8) Joint density measurements will be recorded in the HMA PWL Production Spreadsheet.
- (9) Placement and removal of excess material outside of the final joint edge, to increase joint density at the longitudinal joint testing location, will be done at the contractor's discretion and cost. This excess material and related labor will be considered waste and will not be paid for by the department. Joints with excess material placed outside of the final joint edge to increase joint density or where a notched wedge is used will be considered unconfined joints.
- (10) When not required by the contract, echelon paving may be performed at the contractor's discretion to increase longitudinal joint density and still remain eligible to earn incentive. The additional costs incurred related to echelon paving will not be paid for by the department. If lanes are paved in echelon, the contractor may choose to use a longitudinal vertical joint or notched wedge longitudinal joint as described in [SDD 13c19 HMA Longitudinal Joints](#). Lanes paved in echelon shall be considered confined on both sides of the joint regardless of the selected joint design. The joint between echelon paved lanes shall be placed at the centerline or along lane lines.
- (11) When performing inlay paving below the elevation of the adjacent lane, the longitudinal joint along the adjacent lane to be paved shall be considered unconfined.

**D Measurement**

- (1) The department will measure each side of applicable longitudinal joints, as defined in Section A of this special provision, by the linear foot of pavement acceptably placed. Measurement will be conducted independently for the inside or median side and for the outside or shoulder side of paving lanes with two applicable longitudinal joints. Each paving layer will be measured independently at the time the mat is placed.

**E Payment**

*Add the following as 460.5.2.4 Pay Adjustment for HMA Pavement Longitudinal Joint Density:*

- (1) The department will administer longitudinal joint density adjustments under the Incentive Density HMA Pavement Longitudinal Joints and Disincentive Density HMA Pavement Longitudinal Joints items. The department will adjust pay based on density relative to the specified targets in Section B of this special provision, and linear foot of the HMA Pavement bid item for that subplot as follows:

**PAY ADJUSTMENT FOR HMA PAVEMENT LONGITUDINAL JOINT DENSITY**

PERCENT SUBLLOT DENSITY	PAY ADJUSTMENT PER LINEAR FOOT
ABOVE/BELOW SPECIFIED MINIMUM	
Equal to or greater than +1.0 confined, +2.0 unconfined	\$0.20
From 0.0 to +0.9 confined, 0.0 to +1.9 unconfined	\$0
From -0.1 to -1.0	\$(0.20)
From -1.1 to -2.0	\$(0.40)
From -2.1 to -3.0	\$(0.80)
More than -3.0	<i>REMEDIAL ACTION <sup>[1]</sup></i>

[1] Remedial action must be approved by the engineer and agreed upon at the time of the pre-pave meeting and may include partial sublots as determined and defined in 460.3.3.2(7) of this document. If unacceptable material is removed and replaced per guidance by the engineer, the removal and replacement will be for the full lane width of the side of which the joint was constructed with unacceptable material.

- (2) The department will not assess joint density disincentives for pavement placed in cold weather because of a department-caused delay as specified in [standard spec 450.5.2\(3\)](#).
- (3) The department will not pay incentive on the longitudinal joint density if the traffic lane is in disincentive. A disincentive may be applied for each mainline lane and all joint densities if both qualify for a pay reduction.
- (4) Inlay paving operations will limit payment for additional material to 2 inches wider than the final paving lane width at the centerline.

The department will pay incentive for longitudinal joint density under the following bid items:

ITEM NUMBER	DESCRIPTION	UNIT
SPV.0055.03	Incentive Density HMA Pavement Longitudinal Joints	DOL

The department will administer disincentives under the Disincentive Density HMA Pavement Longitudinal Joints administrative item.

## Appendix

### WisDOT Longitudinal Joint – Core Density Layout

Each QV density location must have a companion density location at any applicable joint. This companion location must share longitudinal stationing with each QV density location and be located transversely with the center of the core 6-inches from the edge of the paving area.

**For HMA Pavement Percent Within Limits QMP projects**, this appears as follows:

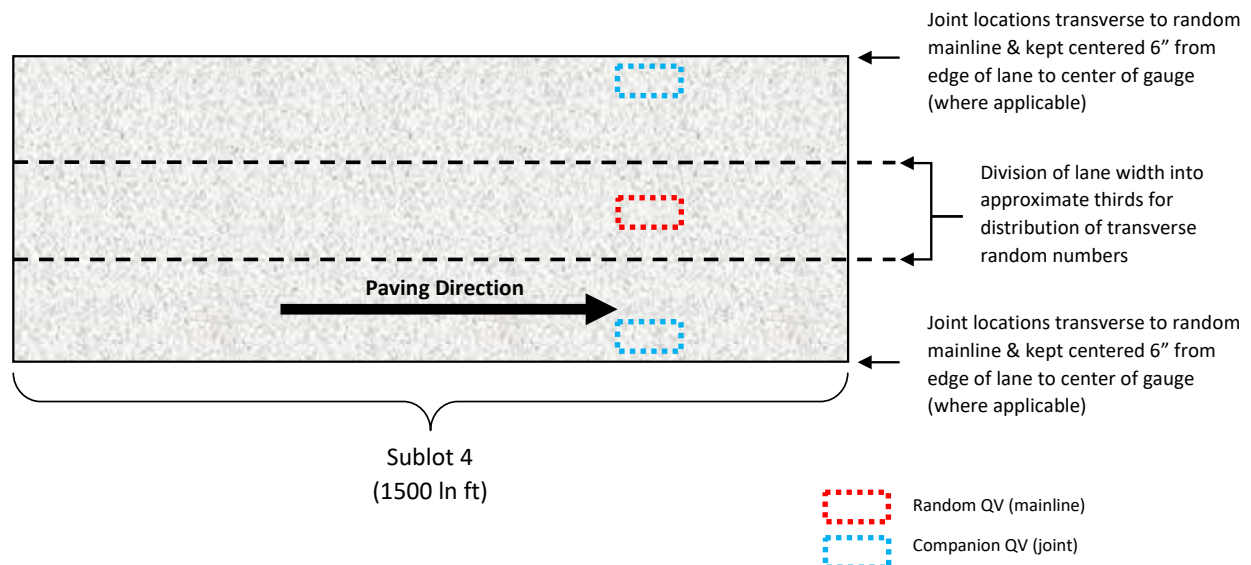

**Further Explanation of PAY ADJUSTMENT FOR HMA PAVEMENT LONGITUDINAL JOINT DENSITY**

**Table**

	Confined				Pay Adjust
	Lower Layer (On Base)		Upper Layer		
	LT/MT	HT	LT/MT	HT	
Mainline Target (SS 460-3)	91.0	92.0	93.0	93.0	-
Confined Target (mainline - 1.5)	89.5	90.5	91.5	91.5	-
Equal to or greater than +1.0	≥ 90.5	≥ 91.5	≥ 92.5	≥ 92.5	\$0.20
From 0.0 to +0.9	90.4 - 89.5	91.4 - 90.5	92.4 - 91.5	92.4 - 91.5	\$0
From -0.1 to -1.0	89.4 - 88.5	90.4 - 89.5	91.4 - 90.5	91.4 - 90.5	(\$0.20)
From -1.1 to -2.0	88.4 - 87.5	89.4 - 88.5	90.4 - 89.5	90.4 - 89.5	(\$0.40)
From -2.1 to -3.0	87.4 - 86.5	88.4 - 87.5	89.4 - 88.5	89.4 - 88.5	(\$0.80)
More than -3.0	< 86.5	< 87.5	< 88.5	< 88.5	REMEDIAL ACTION

	Unconfined				Pay Adjust
	Lower Layer (On Base)		Upper Layer		
	LT/MT	HT	LT/MT	HT	
Mainline Target (SS 460-3)	91.0	92.0	93.0	93.0	-
Unconfined Target (Mainline -3.0)	88.0	89.0	90.0	90.0	-
Equal to or greater than +2.0	≥ 90.0	≥ 91.0	≥ 92.0	≥ 92.0	\$0.20
From 0.0 to +1.9	89.9 - 88.0	90.9 - 89.0	91.9 - 90.0	91.9 - 90.0	\$0
From -0.1 to -1.0	87.9 - 87.0	88.9 - 88.0	89.9 - 89.0	89.9 - 89.0	(\$0.20)
From -1.1 to -2.0	86.9 - 86.0	87.9 - 87.0	88.9 - 88.0	88.9 - 88.0	(\$0.40)
From -2.1 to -3.0	85.9 - 85.0	86.9 - 86.0	87.9 - 87.0	87.9 - 87.0	(\$0.80)
More than -3.0	< 85.0	< 86.0	< 87.0	< 87.0	REMEDIAL ACTION

**27. Ditch Cleaning, Item SPV.0090.01.**

**A Description**

This special provision describes removing existing vegetation, brush, and sediment from the ditch flowline and for grading and shaping the ditch bottom and slopes to restore drainage and match adjacent slopes.

**B (Vacant)**

**C Construction**

Grade and shape the ditch flowline within the roadway right-of-way as necessary to remove existing vegetation and restore unimpeded flow. Do not excavate deeper than 1 foot nor disturb an overall lateral width greater than 10 feet. Grade and trim the lateral areas of disturbance to produce uniform side slope surfaces. Place salvaged topsoil as needed to reestablish the pre-excavated ditch flowline. Dispose of surplus material according to standard spec 205.3.12.

**D Measurement**

The department will measure Ditch Cleaning by the linear foot, acceptably completed.

**E Payment**

The department will pay for measured quantities at the contract unit price under the following bid item:

ITEM NUMBER	DESCRIPTION	UNIT
SPV.0090.01	Ditch Cleaning	LF

Payment is full compensation for removing existing vegetation, brush, and debris, including accumulated sediment; for disposing of excavated materials; and for grading and shaping the ditch bottom and slopes to reestablish a positive ditch flowline.

Salvaged topsoil, seed, and erosion control items will be measured and paid for separately.

## **ADDITIONAL SPECIAL PROVISION 4**

This special provision does not limit the right of the department, prime contractor, or subcontractors at any tier to withhold payment for work not acceptably completed or work subject to an unresolved contract dispute.

### **Payment to First-Tier Subcontractors**

Within 10 calendar days of receiving a progress payment for work completed by a subcontractor, pay the subcontractor for that work. The prime contractor may withhold payment to a subcontractor if, within 10 calendar days of receipt of that progress payment, the prime contractor provides written notification to the subcontractor and the department documenting "just cause" for withholding payment.

The prime contractor is not allowed to withhold retainage from payments due subcontractors.

### **Payment to Lower-Tier Subcontractors**

Ensure that subcontracting agreements at all tiers provide prompt payment rights to lower-tier subcontractors that parallel those granted first-tier subcontractors in this provision.

### **Acceptance and Final Payment**

Within 30 calendar days of receiving the semi-final estimate from the department, submit written certification that subcontractors at all tiers are paid in full for acceptably completed work.



**Additional Special Provision 6**  
**ASP 6 - Modifications to the standard specifications**

*Make the following revisions to the standard specifications:*

**108 Prosecution and Progress**

*Add subsection 108.9.4.1 effective with the November 2023 letting:*

**108.9.4.1 Winter Suspension for Completion Date Contracts**

- (1) The contractor may request a winter suspension for a completion date contract. If the department determines weather conditions do not allow for the completion of the remaining work, the department may approve the contractor’s request and determine the start date of the winter suspension. The end date of the winter suspension is March 31 or a date mutually agreed upon by both parties. For multi-year contracts, the department will only consider winter suspension for the final year of the contract.
- (2) During winter suspension, store all materials in a manner that does not obstruct vehicular and pedestrian traffic and protect the materials from damage. Install traffic control and other safety devices necessary to protect the traveling public and pedestrians. Provide suitable drainage and install temporary erosion control where necessary. If the winter suspension begins when liquidated damages are being assessed, or when the work has not progressed as scheduled and would not have been completed prior to the completion date, the cost of necessary pre-suspension work is incidental. If the winter suspension begins prior to the contract completion date, and the work has progressed as scheduled and would have been completed prior to the completion date, the cost of pre-suspension work will be paid as specified under 109.4.
- (3) For a winter suspension that begins prior to the contract completion date and the work has progressed as scheduled and would have been completed prior to the completion date, the engineer will extend contract time to correspond with the end of the winter suspension and liquidated damages will not be assessed during the winter suspension.
- (4) For a winter suspension that begins when liquidated damages are being assessed or when the work has not progressed as scheduled and would not have been completed prior to the completion date, the engineer will not extend contract time. Time will be suspended until the end of the winter suspension. Liquidated damages will not be assessed during the winter suspension and liquidated damages will resume at the end of the winter suspension.

**310 Open Graded Base**

**310.2 Materials**

*Replace paragraph two with the following effective with the November 2023 letting:*

- (2) The contractor may substitute material conforming to the gradation requirements for crushed aggregate specified in Table 310-01 if that material conforms to the fracture requirements for open-graded crushed gravel specified in 301.2.4.5.

**TABLE 310-01 COARSE AGGREGATE (% passing by weight)**

SEIVE	AASHTO No. 67 <sup>[1]</sup> COARSE AGGREGATE (% PASSING by WEIGHT) AASHTO No. 67
2-inch	-
1 1/2-inch	-
1-inch	100
3/4-inch	90 – 100
1/2-inch	-
3/8-inch	20 – 55
No. 4	0 – 10
No. 8	0 – 5
No. 16	-
No. 30	-

No. 50	-
No. 100	-
No. 200	<=1.5

[1] Size according to AASHTO M43.

**390 Base Patching**

**390.4 Measurement**

*Replace entire section with the following effective with the November 2023 letting:*

- (1) The department will measure Removing Pavement for Base Patching by the cubic yard acceptably completed. Measure the depth from the bottom of the adjacent pavement to the top of the patch.
- (2) The department will measure Base Patching Asphaltic by the ton acceptably completed as specified for asphaltic pavement in 450.4.
- (3) The department will measure Base Patching Concrete HES and Base Patching Concrete SHES by the cubic yard acceptably completed. Measure the depth from the bottom of the adjacent pavement to the top of the patch.

**390.5 Payment**

*Replace entire section with the following effective with the November 2023 letting:*

- (1) The department will pay for measured quantities at the contract unit price under the following bid items:

<u>ITEM NUMBER</u>	<u>DESCRIPTION</u>	<u>UNIT</u>
390.0100	Removing Pavement for Base Patching	CY
390.0201	Base Patching Asphaltic	TON
390.0305	Base Patching Concrete HES	CY
390.0405	Base Patching Concrete SHES	CY

- (2) Payment for Removing Pavement for Base Patching is full compensation for removing old pavement; for preparing the foundation and bringing up to grade. If the engineer orders the contractor to excavate yielding or unstable subgrade materials and backfill with suitable materials, the department will pay for that work with contract bid items or as agreed upon using 109.4.
- (3) Payment for Base Patching Asphaltic is full compensation for providing and compacting asphaltic mixture including asphaltic binder.
- (4) Payment for Base Patching Concrete HES and Base Patching Concrete SHES is full compensation for providing, curing, and protecting concrete. Payment also includes providing tie bars and dowel bars in unhardened concrete and steel within the patch. For tie bars and dowel bars provided in concrete not placed under the contract, the department will pay separately under the Drilled Tie Bars and Drilled Dowel Bars bid items as specified in 416.5.
- (5) Payment for Base Patching SHES also includes providing test data to the engineer as specified in 416.2.4.
- (6) The department will pay for sawing existing concrete pavement for removal under the Sawing Concrete bid item as specified in 690.5.

**460 Hot Mix Asphalt Pavement**

**460.2.8.2.1.3.1 Contracts with 5000 Tons of Mixture or Greater**

*Replace paragraph four with the following effective with the November 2023 letting:*

- (4) Use the test methods identified below, or other methods the engineer approves, to perform the following tests at the frequency indicated:

Blended aggregate gradations:

Drum plants:

- Field extraction by ignition oven according to WTM T308, chemical extraction according to AASHTO T-164 method A or B; or automated extraction according to WTM D8159. Gradation of resulting aggregate sample determined according to WTM T30.
- Belt samples, optional for virgin mixtures, obtained from stopped belt or from the belt discharge using an engineer-approved sampling device and performed according to WTM T11 and T27.

Batch plants:

- Field extraction by ignition oven according to WTM T308, chemical extraction according to AASHTO T-164 method A or B; or automated extraction according to WTM D8159. Gradation of resulting aggregate sample determined according to WTM T30.

Asphalt content (AC) in percent:

Determine AC using one of the following methods:

- AC by ignition oven according to WTM T308.
- AC by chemical extraction according to AASHTO T-164 method A or B.
- AC by automated extraction according to WTM D8159.
- If the department is using an ignition oven to determine AC, conform to WTP H003.
- If the department is not using an ignition oven to determine AC, ignition oven correction factor (IOCF) must still be reverified for any of the reasons listed in WTP H003 Table 2 and conform to WTP H-003 sections 3 through 6.
- Gradation of resulting aggregate sample determined according to WTM T30.

Bulk specific gravity of the compacted mixture:

According to WTM T166.

Theoretical maximum specific gravity:

According to WTM T209.

Air voids ( $V_a$ ) by calculation according to WTM T269.

VMA by calculation according to WTM R35.

#### **460.2.8.3.1.4 Department Verification Testing Requirements**

Replace paragraph three with the following effective with the November 2023 letting:

- (3) The department will perform testing conforming to the following standards:

Bulk specific gravity ( $G_{mb}$ ) of the compacted mixture according to WTM T166.

Maximum specific gravity ( $G_{mm}$ ) according to WTM T209.

Air voids ( $V_a$ ) by calculation according to WTM T269.

VMA by calculation according to WTM R35.

Asphalt content by ignition oven according to WTM T308, chemical extraction according to AASHTO T-164 method A or B, or automated extraction according to WTM D8159. If using an ignition oven to determine AC, conform to WTP H-003.

---

### **503 Prestressed Concrete Members**

#### **503.2.2 Concrete**

Replace paragraph five with the following effective with the November 2023 letting:

- (5) Furnish prestressed concrete members cast from air-entrained concrete, except I-type girders may use non-air-entrained concrete. Use type I, IL, IS, IP, IT, II, or III cement. The contractor may replace up to 30 percent of type I, IL, II, or III cement with an equal weight of fly ash, slag, or a combination of fly ash and slag. Ensure that fly ash conforms to 501.2.4.2.2 and slag conforms to 501.2.4.2.3. Use only one source and replacement rate for work under a single bid item. Use a department-approved air-entraining admixture conforming to 501.2.5.2 for air-entrained concrete. Use only coarse aggregate conforming to 310.2(2).

---

### **604 Slope Paving**

#### **604.2 Materials**

Replace paragraph three with the following effective with the November 2023 letting:

- (3) Under the Slope Paving Crushed Aggregate bid item, furnish crushed stone or crushed gravel conforming to the gradation in Table 604-01, but with the additional requirements that at least 75 percent of the particles, by count, have at least one fractured face. Determine fracture according to WTM D5821.

**TABLE 604-01 COARSE AGGREGATE (% passing by weight)**

<b>AASHTO No. 4<sup>[1]</sup></b>	
SEIVE	COARSE AGGREGATE (% PASSING by WEIGHT) AASHTO No. 4
2-inch	100
1 1/2-inch	90 - 100
1-inch	20 - 55
3/4-inch	0 - 15
1/2-inch	-
3/8-inch	0 - 5
No. 4	-
No. 8	-
No. 16	-
No. 30	-
No. 50	-
No. 100	-
No. 200	<=1.5

<sup>[1]</sup> Size according to AASHTO M43.

**612 Underdrains**

**612.3.9 Trench Underdrains**

*Replace paragraph one with the following effective with the November 2023 letting:*

- (1) Under the Underdrain Trench bid item, excavate and backfill underdrain trenches. Backfill with coarse aggregate gradation conforming to 604.2(3). Before backfilling place geotextile as the plans show.

**614 Semi-rigid Barrier Systems and End Treatments**

**614.2.6 Sand Barrel Arrays**

*Replace paragraph one with the following effective with the November 2023 letting:*

- (1) Furnish sand barrels from the APL. Use fine aggregate conforming to gradation shown in Table 614-2 mixed with sodium chloride conforming to AASHTO M143. Apply an object marker to front-most barrel in the array.

**TABLE 614-2 FINE AGGREGATE GRADATION**

SEIVE	FINE AGGREGATE (% PASSING by WEIGHT)
3/8-inch	100
No. 4	90 - 100
No. 8	-
No. 16	45 - 85
No. 30	-
No. 50	5 - 30
No. 100	0 - 10
No. 200	<=3.5

---

**628 Erosion Control****628.2.13 Rock Bags**

*Replace paragraph two with the following effective with the November 2023 letting:*

- (2) Fill the bags with a clean, sound, hard, durable, engineer-approved coarse aggregate conforming by visual inspection to the gradation specified for coarse aggregate gradation in 604.2(3).
- 

**639 Drilling Wells****639.2.1 General**

*Replace paragraph two with the following effective with the November 2023 letting:*

- (2) For grout use fine aggregate conforming to 501.2.7.2; and gradation conforming to 614.2.6(1); and type I, IL, IS, IP, or IT cement.
- 

**652 Electrical Conduit****652.3.1.2 Installing Underground**

*Replace paragraph two with the following effective with the November 2023 letting:*

- (2) Excavate trenches true to line and grade to provide the conduit uniform bearing throughout its length. Do not backfill the trench before inspecting the conduit. Carefully tamp the backfill in place as specified for placing backfill in layers in 651.3. Place at least 0.7 cubic feet of coarse aggregate gradation conforming to 604.2(3) directly under each drainage hole.
- 

---

**ERRATA**

---

**390.3.4 Special High Early Strength Concrete Patching**

*Correct errata link in paragraph (1) by changing from 416.3.8 to 416.3.7.*

- (1) Construct as specified for special high early strength repairs under [416.3.7](#) except as follows:
- The contractor may delay removal for up to 14 calendar days after cutting the existing pavement.
  - Open to traffic as specified for concrete base in [320.3](#).

## ADDITIONAL SPECIAL PROVISION 7

### A. Reporting 1<sup>st</sup> Tier and DBE Payments During Construction

1. Comply with reporting requirements specified in the department's Civil Rights Compliance, Contractor's User Manual, Sublets and Payments.
2. Report payments to all DBE firms within 10 calendar days of receipt of a progress payment by the department or a contractor for work performed, materials furnished, or materials stockpiled by a DBE firm. Report the payment as specified in A(1) for all work satisfactorily performed and for all materials furnished or stockpiled.
3. Report payments to all first tier subcontractor relationships within 10 calendar days of receipt of a progress payment by the department for work performed. Report the payment as specified in A(1) for all work satisfactorily performed.
4. All tiers shall report payments as necessary to comply with the DBE payment requirement as specified in A(2).
5. DBE firms must enter all payments to DBE and non-DBE firms regardless of tier.
6. Require all first tier relationships, DBE firms and all other tier relationships necessary to comply with the DBE payment requirement in receipt of a progress payment by contractor to acknowledge receipt of payment as specified in A(1), (2), (3) and (4).
7. All agreements made by a contractor shall include the provisions in A(1), (2), (3), (4), (5), and (6), and shall be binding on all first tier subcontractor relationships, all contractors and subcontractors utilizing DBE firms on the project, and all payments from DBE firms.

### B. Costs for conforming to this special provision are incidental to the contract.

NOTE: CRCS Prime Contractor payment is currently not automated and will need to be manually loaded into the Civil Rights Compliance System. Copies of prime contractor payments received (check or ACH) will have to be forwarded to [paul.ndon@dot.wi.gov](mailto:paul.ndon@dot.wi.gov) within 5 days of payment receipt to be logged manually.

\*\*\*Additionally, for information on Subcontractor Sublet assignments, Subcontractor Payments and Payment Tracking, please refer to the CRCS Payment and Sublets manual at:

<https://wisconsindot.gov/Documents/doing-bus/civil-rights/labornwage/crcs-payments-sublets-manual.pdf>

## **ADDITIONAL SPECIAL PROVISION 9**

### **Electronic Certified Payroll or Labor Data Submittal**

- (1) Use the department's Civil Rights Compliance System (CRCS) to electronically submit certified payroll reports for contracts with federal funds and labor data for contracts with state funds only. Details are available online through the department's highway construction contractor information (HCCI) site on the Labor, Wages, and EEO Information page at:  
<https://wisconsindot.gov/Pages/doing-bus/civil-rights/labornwage/default.aspx>
- (2) Ensure that all tiers of subcontractors, including all trucking firms, either submit their weekly certified payroll reports (contracts with federal funds) or labor data (contracts with state funds only) electronically through CRCS. These payrolls or labor data are due within seven calendar days following the close of the payroll period. Every firm providing physical labor towards completing the project is a subcontractor under this special provision.
- (3) Upon receipt of contract execution, promptly make all affected firms aware of the requirements under this special provision and arrange for them to receive CRCS training as they are about to begin their submittals. The department will provide training either in a classroom setting at one of our regional offices or by telephone. Contact Paul Ndon at (414) 438-4584 to schedule the training.
- (4) The department will reject all paper submittals for information required under this special provision. All costs for conforming to this special provision are incidental to the contract.
- (5) Firms wishing to export payroll/labor data from their computer system into CRCS should have their payroll coordinator contact Paul Ndon at [paul.ndon@dot.wi.gov](mailto:paul.ndon@dot.wi.gov). Not every contractor's payroll system is capable of producing export files. For details, see Section 4.8 CPR Auto Submit (Data Mapping) on pages 49-50; 66-71 of the CRCS Payroll Manual at:  
<https://wisconsindot.gov/Documents/doing-bus/civil-rights/labornwage/crcs-payroll-manual.pdf>

## NON-DISCRIMINATION PROVISIONS

**During the performance of this contract, the contractor, for itself, its assignees, and successors in interest (hereinafter referred to as the "contractor") agrees as follows:**

**1. Compliance with Regulations:** The contractor (hereinafter includes consultants) will comply with the Acts and the Regulations relative to Non-discrimination in Federally-assisted programs of the U.S. Department of Transportation, Federal Highway Administration, as they may be amended from time to time, which are herein incorporated by reference and made a part of this contract.

**2. Non-discrimination:** The contractor, with regard to the work performed by it during the contract, will not discriminate on the grounds of race, color, or national origin in the selection and retention of subcontractors, including procurements of materials and leases of equipment. The contractor will not participate directly or indirectly in the discrimination prohibited by the Acts and the Regulations, including employment practices when the contract covers any activity, project, or program set forth in Appendix B of 49 CFR Part 21.

**3. Solicitations for Subcontracts, Including Procurements of Materials and Equipment:** In all solicitations, either by competitive bidding, or negotiation made by the contractor for work to be performed under a subcontract, including procurements of materials, or leases of equipment, each potential subcontractor or supplier will be notified by the contractor of the contractor's obligations under this contract and the Acts and the Regulations relative to Non-discrimination on the grounds of race, color, or national origin.

**4. Information and Reports:** The contractor will provide all information and reports required by the Acts, the Regulations, and directives issued pursuant thereto and will permit access to its books, records, accounts, other sources of information, and its facilities as may be determined by the Recipient or the Federal Highway Administration to be pertinent to ascertain compliance with such Acts, Regulations, and instructions. Where any information required of a contractor is in the exclusive possession of another who fails or refuses to furnish the information, the contractor will so certify to the Recipient or the Federal Highway Administration, as appropriate, and will set forth what efforts it has made to obtain the information.

**5. Sanctions for Noncompliance:** In the event of a contractor's noncompliance with the Non-discrimination provisions of this contract, the Recipient will impose such contract sanctions as it or the Federal Highway Administration may determine to be appropriate, including, but not limited to:

- a. Withholding payments to the contractor under the contract until the contractor complies; and/or
- b. Cancelling, terminating, or suspending a contract, in whole or in part.

**6. Incorporation of Provisions:** The contractor will include the provisions of paragraphs one through six in every subcontract, including procurements of materials and leases of equipment, unless exempt by the Acts, the Regulations and directives issued pursuant thereto. The contractor will take action with respect to any subcontract or procurement as the Recipient or the Federal Highway Administration may direct as a means of enforcing such provisions including sanctions for noncompliance. Provided, that if the contractor becomes involved in, or is threatened with litigation by a subcontractor, or supplier because of such direction, the contractor may request the Recipient to enter into any litigation to protect the interests of the Recipient. In addition, the contractor may request the United States to enter into the litigation to protect the interests of the United States.



**During the performance of this contract, the contractor, for itself, its assignees, and successors in interest (hereinafter referred to as the "contractor") agrees to comply with the following non-discrimination statutes and authorities; including but not limited to:**

**Pertinent Non-Discrimination Authorities:**

- Title VI of the Civil Rights Act of 1964 (42 U.S.C. § 2000d et seq., 78 stat. 252), (prohibits discrimination on the basis of race, color, national origin); and 49 CFR Part 21.
- The Uniform Relocation Assistance and Real Property Acquisition Policies Act of 1970, (42 U.S.C. § 4601), (prohibits unfair treatment of persons displaced or whose property has been acquired because of Federal or Federal-aid programs and projects);
- Federal-Aid Highway Act of 1973, (23 U.S.C. § 324 et seq.), (prohibits discrimination on the basis of sex);
- Section 504 of the Rehabilitation Act of 1973, (29 U.S.C. § 794 et seq.), as amended, (prohibits discrimination on the basis of disability); and 49 CFR Part 27;
- The Age Discrimination Act of 1975, as amended, (42 U.S.C. § 6101 et seq.), (prohibits discrimination on the basis of age);
- Airport and Airway Improvement Act of 1982, (49 USC § 471, Section 47123), as amended, (prohibits discrimination based on race, creed, color, national origin, or sex);
- The Civil Rights Restoration Act of 1987, (PL 100-209), (Broadened the scope, coverage and applicability of Title VI of the Civil Rights Act of 1964, The Age Discrimination Act of 1975 and Section 504 of the Rehabilitation Act of 1973, by expanding the definition of the terms "programs or activities" to include all of the programs or activities of the Federal-aid recipients, sub-recipients and contractors, whether such programs or activities are Federally funded or not);
- Titles II and III of the Americans with Disabilities Act, which prohibit discrimination on the basis of disability in the operation of public entities, public and private transportation systems, places of public accommodation, and certain testing entities (42 U.S.C. §§ 12131-12189) as implemented by Department of Transportation regulations at 49 C.F.R. parts 37 and 38;
- The Federal Aviation Administration's Non-discrimination statute (49 U.S.C. § 47123) (prohibits discrimination on the basis of race, color, national origin, and sex);
- Executive Order 12898, Federal Actions to Address Environmental Justice in Minority Populations and Low-Income Populations, which ensures Non-discrimination against minority populations by discouraging programs, policies, and activities with disproportionately high and adverse human health or environmental effects on minority and low-income populations;
- Executive Order 13166, Improving Access to Services for Persons with Limited English Proficiency, and resulting agency guidance, national origin discrimination includes discrimination because of Limited English proficiency (LEP). To ensure compliance with Title VI, you must take reasonable steps to ensure that LEP persons have meaningful access to your programs (70 Fed. Reg. at 74087 to 74100);
- Title IX of the Education Amendments of 1972, as amended, which prohibits you from discriminating because of sex in education programs or activities (20 U.S.C. 1681 et seq).

## BUY AMERICA PROVISION

Buy America (as documented in M-22-11 from the Office of Management and Budget: <https://www.whitehouse.gov/wp-content/uploads/2022/04/M-22-11.pdf>) shall be domestic products and permanently incorporated in this project as classified in the following three categories, and as noted in the Construction and Materials Manual (CMM):

### 1. Iron and Steel

All iron and steel manufacturing and coating processes (from smelting forward in the manufacturing process) must have occurred within the United States. Coating includes epoxy coating, galvanizing, painting and any other coating that protects or enhances the value of a material subject to the requirements of Buy America.

The exemption of the iron and steel manufacturing and coating processes Buy America requirement is the minimal use of foreign materials if the total cost of such material permanently incorporated in the product does not exceed one-tenth of one percent (1/10 of 1%) of the total contract cost or \$2,500.00, whichever is greater. For purposes of this paragraph, the cost is that shown to be the value of the subject products as they are delivered to the project.

### 2. Manufactured Product

All manufactured products (as defined in CMM 228.5) are covered under a previous waiver from 1983, and are currently exempt from Buy America.

### 3. Construction Material

All construction materials (as defined in OMB M-22-11 and as referenced in CMM 228.5) must comply with Buy America. No exemptions (0.0%) are allowed.

The contractor shall take actions and provide documentation conforming to CMM 228.5 to ensure compliance with this Buy America provision.

<https://wisconsindot.gov/rdwy/cmm/cm-02-28.pdf>

Upon completion of the project, certify to the engineer, in writing using department form DT4567 that all iron and steel, manufactured products, and construction materials conform to this Buy America provision.

Form DT4567 is available at: <https://wisconsindot.gov/Documents/formdocs/dt4567.docx>

Attach a list of iron or steel exemptions and their associated costs to the certification form.



Proposal Schedule of Items

Proposal ID: 20231212033 Project(s): 7070-06-72

Federal ID(s): N/A

SECTION: 0001 Contract Items

Alt Set ID: Alt Mbr ID:

Proposal Line Number	Item ID Description	Approximate Quantity and Units	Unit Price	Bid Amount
0002	201.0205 Grubbing	9.000 STA	_____.	_____.
0004	203.0100 Removing Small Pipe Culverts	5.000 EACH	_____.	_____.
0006	203.0211.S Abatement of Asbestos Containing Material (structure) 01. B-9-26	1.000 EACH	_____.	_____.
0008	203.0220 Removing Structure (structure) 01. Sta 98+72	1.000 EACH	_____.	_____.
0010	203.0220 Removing Structure (structure) 02. Sta 196+26	1.000 EACH	_____.	_____.
0012	204.0110 Removing Asphaltic Surface	370.000 SY	_____.	_____.
0014	204.0115 Removing Asphaltic Surface Butt Joints	5,150.000 SY	_____.	_____.
0016	204.0165 Removing Guardrail	378.000 LF	_____.	_____.
0018	205.0100 Excavation Common	4,247.000 CY	_____.	_____.
0020	208.0100 Borrow	805.000 CY	_____.	_____.
0022	208.1500.S Temporary Lane Shift During Culvert Work	5.000 EACH	_____.	_____.
0024	209.0200.S Backfill Controlled Low Strength	50.000 CY	_____.	_____.
0026	210.1500 Backfill Structure Type A	30.000 TON	_____.	_____.
0028	211.0400 Prepare Foundation for Asphaltic Shoulders	10.000 STA	_____.	_____.
0030	211.0700.S Prepare Foundation for CIR Base Layer (project) 01. 7070-06-72	1.000 EACH	_____.	_____.



Proposal Schedule of Items

Proposal ID: 20231212033 Project(s): 7070-06-72

Federal ID(s): N/A

SECTION: 0001 Contract Items

Alt Set ID: Alt Mbr ID:

Proposal Line Number	Item ID Description	Approximate Quantity and Units	Unit Price	Bid Amount
0032	211.0800.S Base Repair for CIR Layer	1,000.000 CY	_____.	_____.
0034	213.0100 Finishing Roadway (project) 01. 7070-06-72	1.000 EACH	_____.	_____.
0036	305.0110 Base Aggregate Dense 3/4-Inch	5,020.000 TON	_____.	_____.
0038	305.0120 Base Aggregate Dense 1 1/4-Inch	2,010.000 TON	_____.	_____.
0040	327.1000.S CIR Asphaltic Base Layer	92,100.000 SY	_____.	_____.
0042	415.0070 Concrete Pavement 7-Inch	40.000 SY	_____.	_____.
0044	415.0410 Concrete Pavement Approach Slab	104.000 SY	_____.	_____.
0046	455.0605 Tack Coat	11,765.000 GAL	_____.	_____.
0048	455.0770.S Asphalt Stabilizing Agent	315.000 TON	_____.	_____.
0050	460.0105.S HMA Percent Within Limits (PWL) Test Strip Volumetrics	1.000 EACH	_____.	_____.
0052	460.6645 HMA Pavement 5 MT 58-34 V	14,950.000 TON	_____.	_____.
0054	465.0105 Asphaltic Surface	640.000 TON	_____.	_____.
0056	465.0110 Asphaltic Surface Patching	25.000 TON	_____.	_____.
0058	465.0120 Asphaltic Surface Driveways and Field Entrances	38.000 TON	_____.	_____.
0060	465.0560 Asphaltic Rumble Strips, Centerline	25,600.000 LF	_____.	_____.



Proposal Schedule of Items

Proposal ID: 20231212033 Project(s): 7070-06-72

Federal ID(s): N/A

SECTION: 0001 Contract Items

Alt Set ID: Alt Mbr ID:

Proposal Line Number	Item ID Description	Approximate Quantity and Units	Unit Price	Bid Amount
0062	502.3200 Protective Surface Treatment	350.000 SY	_____.	_____.
0064	502.3205 Pigmented Surface Sealer Reseal	70.000 SY	_____.	_____.
0066	509.0301 Preparation Decks Type 1	150.000 SY	_____.	_____.
0068	509.0302 Preparation Decks Type 2	60.000 SY	_____.	_____.
0070	509.0505.S Cleaning Decks to Reapply Concrete Masonry Overlay	350.000 SY	_____.	_____.
0072	509.1500 Concrete Surface Repair	370.000 SF	_____.	_____.
0074	509.2000 Full-Depth Deck Repair	15.000 SY	_____.	_____.
0076	509.2500 Concrete Masonry Overlay Decks	32.000 CY	_____.	_____.
0078	509.9005.S Removing Concrete Masonry Deck Overlay (structure) 01. B-9-26	350.000 SY	_____.	_____.
0080	509.9010.S Removing Asphaltic Concrete Deck Overlay (structure) 01. B-9-26	350.000 SY	_____.	_____.
0082	520.1024 Apron Endwalls for Culvert Pipe 24-Inch	2.000 EACH	_____.	_____.
0084	520.1030 Apron Endwalls for Culvert Pipe 30-Inch	2.000 EACH	_____.	_____.
0086	520.3424 Culvert Pipe Class III-A Non-metal 24-Inch	72.000 LF	_____.	_____.
0088	520.3430 Culvert Pipe Class III-A Non-metal 30-Inch	84.000 LF	_____.	_____.
0090	520.8700 Cleaning Culvert Pipes	5.000 EACH	_____.	_____.



Proposal Schedule of Items

Proposal ID: 20231212033 Project(s): 7070-06-72

Federal ID(s): N/A

SECTION: 0001 Contract Items

Alt Set ID: Alt Mbr ID:

Proposal Line Number	Item ID Description	Approximate Quantity and Units	Unit Price	Bid Amount
0092	522.0424 Culvert Pipe Reinforced Concrete Class IV 24-Inch	54.000 LF	_____.	_____.
0094	522.0430 Culvert Pipe Reinforced Concrete Class IV 30-Inch	80.000 LF	_____.	_____.
0096	522.0448 Culvert Pipe Reinforced Concrete Class IV 48-Inch	64.000 LF	_____.	_____.
0098	522.1024 Apron Endwalls for Culvert Pipe Reinforced Concrete 24-Inch	2.000 EACH	_____.	_____.
0100	522.1030 Apron Endwalls for Culvert Pipe Reinforced Concrete 30-Inch	2.000 EACH	_____.	_____.
0102	522.1048 Apron Endwalls for Culvert Pipe Reinforced Concrete 48-Inch	2.000 EACH	_____.	_____.
0104	601.0588 Concrete Curb & Gutter 4-Inch Sloped 36-Inch Type TBT	100.000 LF	_____.	_____.
0106	601.0590 Concrete Curb & Gutter 4-Inch Sloped 36-Inch Type TBTT	101.000 LF	_____.	_____.
0108	602.3010 Concrete Surface Drains	8.000 CY	_____.	_____.
0110	603.8000 Concrete Barrier Temporary Precast Delivered	475.000 LF	_____.	_____.
0112	603.8125 Concrete Barrier Temporary Precast Installed	950.000 LF	_____.	_____.
0114	606.0200 Riprap Medium	154.000 CY	_____.	_____.
0116	614.0905 Crash Cushions Temporary	4.000 EACH	_____.	_____.
0118	614.2300 MGS Guardrail 3	87.500 LF	_____.	_____.



Proposal Schedule of Items

Proposal ID: 20231212033 Project(s): 7070-06-72

Federal ID(s): N/A

SECTION: 0001 Contract Items

Alt Set ID: Alt Mbr ID:

Proposal Line Number	Item ID Description	Approximate Quantity and Units	Unit Price	Bid Amount
0120	614.2500 MGS Thrie Beam Transition	160.000 LF	_____.	_____.
0122	614.2610 MGS Guardrail Terminal EAT	4.000 EACH	_____.	_____.
0124	618.0100 Maintenance and Repair of Haul Roads (project) 01. 7070-06-72	1.000 EACH	_____.	_____.
0126	619.1000 Mobilization	1.000 EACH	_____.	_____.
0128	624.0100 Water	50.000 MGAL	_____.	_____.
0130	625.0500 Salvaged Topsoil	7,990.000 SY	_____.	_____.
0132	627.0200 Mulching	2,250.000 SY	_____.	_____.
0134	628.1504 Silt Fence	2,550.000 LF	_____.	_____.
0136	628.1520 Silt Fence Maintenance	2,550.000 LF	_____.	_____.
0138	628.1905 Mobilizations Erosion Control	2.000 EACH	_____.	_____.
0140	628.1910 Mobilizations Emergency Erosion Control	1.000 EACH	_____.	_____.
0142	628.2004 Erosion Mat Class I Type B	5,740.000 SY	_____.	_____.
0144	628.7504 Temporary Ditch Checks	120.000 LF	_____.	_____.
0146	628.7555 Culvert Pipe Checks	139.000 EACH	_____.	_____.
0148	629.0210 Fertilizer Type B	6.000 CWT	_____.	_____.
0150	630.0120 Seeding Mixture No. 20	228.000 LB	_____.	_____.



Proposal Schedule of Items

Proposal ID: 20231212033 Project(s): 7070-06-72

Federal ID(s): N/A

SECTION: 0001 Contract Items

Alt Set ID: Alt Mbr ID:

Proposal Line Number	Item ID Description	Approximate Quantity and Units	Unit Price	Bid Amount
0152	630.0500 Seed Water	189.000 MGAL	_____.	_____.
0154	633.5200 Markers Culvert End	10.000 EACH	_____.	_____.
0156	638.2102 Moving Signs Type II	6.000 EACH	_____.	_____.
0158	638.4000 Moving Small Sign Supports	6.000 EACH	_____.	_____.
0160	642.5001 Field Office Type B	1.000 EACH	_____.	_____.
0162	643.0300 Traffic Control Drums	1,880.000 DAY	_____.	_____.
0164	643.0420 Traffic Control Barricades Type III	40.000 DAY	_____.	_____.
0166	643.0705 Traffic Control Warning Lights Type A	80.000 DAY	_____.	_____.
0168	643.0715 Traffic Control Warning Lights Type C	1,000.000 DAY	_____.	_____.
0170	643.0900 Traffic Control Signs	3,250.000 DAY	_____.	_____.
0172	643.1000 Traffic Control Signs Fixed Message	64.000 SF	_____.	_____.
0174	643.3165 Temporary Marking Line Paint 6-Inch	28,660.000 LF	_____.	_____.
0176	643.3170 Temporary Marking Line Epoxy 6-Inch	16,550.000 LF	_____.	_____.
0178	643.3180 Temporary Marking Line Removable Tape 6-Inch	240.000 LF	_____.	_____.
0180	643.3805 Temporary Marking Stop Line Paint 18-Inch	24.000 LF	_____.	_____.
0182	643.5000 Traffic Control	1.000 EACH	_____.	_____.





Proposal Schedule of Items

Proposal ID: 20231212033 Project(s): 7070-06-72

Federal ID(s): N/A

SECTION: 0001 Contract Items

Alt Set ID: Alt Mbr ID:

Proposal Line Number	Item ID Description	Approximate Quantity and Units	Unit Price	Bid Amount
0184	645.0120 Geotextile Type HR	521.000 SY	_____.	_____.
0186	646.2040 Marking Line Grooved Wet Ref Epoxy 6-Inch	70,050.000 LF	_____.	_____.
0188	646.9000 Marking Removal Line 4-Inch	750.000 LF	_____.	_____.
0190	648.0100 Locating No-Passing Zones	5.250 MI	_____.	_____.
0192	650.5500 Construction Staking Curb Gutter and Curb & Gutter	201.000 LF	_____.	_____.
0194	650.6000 Construction Staking Pipe Culverts	5.000 EACH	_____.	_____.
0196	650.8000 Construction Staking Resurfacing Reference	27,730.000 LF	_____.	_____.
0198	650.9911 Construction Staking Supplemental Control (project) 01. 7070-06-72	1.000 EACH	_____.	_____.
0200	650.9920 Construction Staking Slope Stakes	366.000 LF	_____.	_____.
0202	661.0101 Temporary Traffic Signals for Bridges (structure) 01. B-09-26	1.000 EACH	_____.	_____.
0204	690.0150 Sawing Asphalt	675.000 LF	_____.	_____.
0206	715.0720 Incentive Compressive Strength Concrete Pavement	500.000 DOL	1.00000	500.00
0208	740.0440 Incentive IRI Ride	20,950.000 DOL	1.00000	20,950.00
0210	SPV.0035 Special 01. Partially Grouted Riprap	30.000 CY	_____.	_____.



Proposal Schedule of Items

Proposal ID: 20231212033 Project(s): 7070-06-72

Federal ID(s): N/A

SECTION: 0001 Contract Items

Alt Set ID: Alt Mbr ID:

Proposal Line Number	Item ID Description	Approximate Quantity and Units	Unit Price	Bid Amount
0212	SPV.0055 Special 01. Incentive Density PWL HMA Pavement	11,340.000 DOL	1.00000	11,340.00
0214	SPV.0055 Special 02. Incentive Air Voids HMA Pavement	14,950.000 DOL	1.00000	14,950.00
0216	SPV.0055 Special 03. Incentive Density HMA Pavement Longitudinal Joints	11,050.000 DOL	1.00000	11,050.00
0218	SPV.0090 Special 01. Ditch Cleaning	1,590.000 LF	_____.	_____.
<b>Section: 0001</b>			<b>Total:</b>	_____.
			<b>Total Bid:</b>	_____.

**PLEASE ATTACH ADDENDA HERE**





## Wisconsin Department of Transportation

---

November 28, 2023

**Division of Transportation Systems  
Development**

Bureau of Project Development  
4822 Madison Yards Way, 4<sup>th</sup> Floor South  
Madison, WI 53705

Telephone: (608) 266-1631  
Facsimile (FAX): (608) 266-8459

### **NOTICE TO ALL CONTRACTORS:**

#### **Buy America Provision Addendum #01**

#### **Letting of December 12, 2023**

Attached is a copy of the revised Buy America Provision that are included in all proposals in the December 12, 2023 letting.

The responsibility for notifying potential subcontractors and suppliers of these changes remains with the prime contractors.

Sincerely,

*Mike Coleman*

Proposal Development Specialist  
Proposal Management Section

## BUY AMERICA PROVISION

Buy America (as documented in [88 FR 57750 \(2 CFR part 184 and 200\)](#) from the Office of Management and Budget: [Federal Register: Guidance for Grants and Agreements](#) ) shall be domestic products and permanently incorporated in this project as classified in the following three categories, and as noted in the Construction and Materials Manual (CMM):

### 1. Iron and Steel

All iron and steel manufacturing and coating processes (from the initial melting stage through the application of coatings) must have occurred within the United States. Coating includes epoxy coating, galvanizing, painting and any other coating that protects or enhances the value of a material subject to the requirements of Buy America.

The exemption of the iron and steel manufacturing and coating processes Buy America requirement is the minimal use of foreign materials if the total cost of such material permanently incorporated in the product does not exceed one-tenth of one percent (1/10 of 1%) of the total contract cost or \$2,500.00, whichever is greater. For purposes of this paragraph, the cost is that shown to be the value of the subject products as they are delivered to the project.

### 2. Manufactured Product

All manufactured products (as defined in CMM 228.5) are covered under a previous waiver from 1983 and are currently exempt from Buy America.

### 3. Construction Material

All construction materials (as defined in [88 FR 57750 \(2 CFR part 184 and 200\)](#) and as referenced in CMM 228.5) must comply with Buy America. All manufacturing process of construction materials must occur in the United States.

[88 FR 55817 \(DOT-OST-2022-0124\)](#) allows a limited waiver of Buy America requirements for de minimis costs and small grants.

- The Total value of the non-compliant products is no more than the lesser of \$1,000,000 or 5% of total applicable costs for the project<sup>1</sup>; or
- The total amount of Federal financial assistance applied to the project, through awards or subaward, is below \$500,000<sup>2</sup>

The contractor shall take actions and provide documentation conforming to CMM 228.5 to ensure compliance with this Buy America provision.

<https://wisconsin.gov/rdwy/cmm/cm-02-28.pdf>

Upon completion of the project, certify to the engineer, in writing using department form DT4567 that all iron and steel, manufactured products, and construction materials conform to this Buy America provision.

Form DT4567 is available at: <https://wisconsin.gov/Documents/formdocs/dt4567.docx>

Attach a list of iron or steel and construction material exemptions and their associated costs to the certification form.

---

<sup>1</sup> The de minimis public interest waiver does not apply to iron and steel subject to the requirements of 23 U.S.C. 313 on financial assistance administered by FHWA. The de minimis threshold in 23 CFR 635.410(b)(4) continues to apply for iron and steel.

<sup>2</sup> The small grant portion of the waiver does not apply to iron, steel, and manufactured goods subject to the requirements of 49 U.S.C. 22905(a).



## Wisconsin Department of Transportation

---

November 28, 2023

**Division of Transportation Systems  
Development**

Bureau of Project Development  
4822 Madison Yards Way, 4<sup>th</sup> Floor South  
Madison, WI 53705

Telephone: (608) 266-1631  
Facsimile (FAX): (608) 266-8459

### NOTICE TO ALL CONTRACTORS:

**Proposal #33: 7070-06-72**  
**Augusta – Cadott**  
**Eau Claire/Chippewa Co Ln to STH 29**  
**STH 27**  
**Chippewa County**

### Letting of December 12, 2023

This is Addendum No. 01, which provides for the following:

#### Special Provisions:

Added Special Provisions	
Article No.	Description
28	Notice to Contractor, Electronic Load Tickets

The responsibility for notifying potential subcontractors and suppliers of these changes remains with the prime contractor.

Sincerely,

*Mike Coleman*

Proposal Development Specialist  
Proposal Management Section

**ADDENDUM NO. 01**

**7070-06-721**

**November 28, 2023**

**Special Provisions**

**28. Notice to Contractor, Electronic Load Tickets.**

*Replace standard spec 109.1.4.3 (1) with the following:*

Submit an electronic ticket for each load of material. Include the information as specified in 109.1.4.2 on each electronic ticket. If there is a failure in the electronic ticket system, provide a printed ticket for each load of material as a substitute for electronic tickets.

END OF ADDENDUM





# Wisconsin Department of Transportation

## Division of Transportation Systems Development

Bureau of Project Development  
4822 Madison Yards Way, 4<sup>th</sup> Floor South  
Madison, WI 53705

November 30, 2023

Telephone: (608) 266-1631  
Facsimile (FAX): (608) 266-8459

### NOTICE TO ALL CONTRACTORS:

**Proposal #33: 7070-06-72**  
**Augusta - Cadott**  
**Eau Claire/Chippewa Co Ln to STH 29**  
**STH 27**  
**Chippewa County**

### Letting of December 12, 2023

This is Addendum No. 02, which provides for the following:

#### Special Provisions:

Revised Special Provisions	
Article No.	Description
4	Traffic

#### Schedule of Items:

Revised Bid Item Quantities					
Bid Item	Item Description	Unit	Proposal Total Prior to Addendum	Proposal Quantity Change (-)	Proposal Total After Addendum
204.0115	Removing Asphaltic Surface Butt Joints	SY	5,150	155	5,305
455.0605	Tack Coat	GAL	11,765	675	12,440
460.6645	HMA Pavement 5 MT 58-34 V	TON	14,950	950	15,900
465.0560	Asphaltic Rumble Strips, Centerline	LF	25,600	100	25,700
643.0300	Traffic Control Drums	DAY	1,880	200	2,080
643.0300	Traffic Control Signs	DAY	3,250	375	3,625
643.3165	Temporary Marking Line Paint 6-Inch	LF	28,660	4420	33,080
643.3170	Temporary Marking Line Epoxy 6-Inch	LF	16,550	2170	18,720
646.2040	Marking Line Grooved Wet Ref Epoxy 6-Inch	LF	70,050	4351	74,401
648.0100	Locating No-Passing Zones	MI	5.25	0.20	5.45
650.8000	Construction Staking Resurfacing Reference	LF	27,730	1046	28,776
740.0440	Incentive IRI Ride	DOL	20,950	800	21,750
SPV.0055.01	Incentive Density PWL HMA Pavement	DOL	11,340	470	11,810

SPV.0055.02	Incentive Air Voids HMA Pavement	DOL	14,950	950	15,900
SPV.0055.03	Incentive Density HMA Pavement Longitudinal Joints	DOL	11,050	420	11,470

<b>Added Bid Item Quantities</b>					
Bid Item	Item Description	Unit	Proposal Total Prior to Addendum	Quantity Added	Proposal Total After Addendum
204.0120	Removing Asphaltic Surface Milling	SY	0	5,420	5,420
211.0101.01	Prepare Foundation for Asphaltic Paving (project) 01. 7070-06-72	EACH	0	1	1
305.0500	Shaping Shoulders	STA	0	578	578
646.7120	Marking Diagonal Epoxy 12-Inch	LF	0	40	40

**Plan Sheets:**

<b>Revised Plan Sheets</b>	
Plan Sheet	Plan Sheet Title (brief description of changes to sheet)
1	Title Sheet (Update to end of project and project length)
3	Project Overview (Update to project end station and leaders)
15	Miscellaneous Quantities Sheet (Revised and added items)
16	Miscellaneous Quantities Sheet (Organization of items)
17	Miscellaneous Quantities Sheet (Added items)
18	Miscellaneous Quantities Sheet (Revised and added items)
21	Miscellaneous Quantities Sheet (Revised and added items)
22	Miscellaneous Quantities Sheet (Revised items)
32	Plan Sheets (Revised project limits)

<b>Added Plan Sheets</b>	
Plan Sheet	Plan Sheet Title (brief description of why sheet was added)
4A	Typical Sections (Added existing typical sections)
5A	Typical Sections (Added proposed typical sections)
9A	Construction Details (Added construction details)
101A	SDD (Added for Median Island Pavement Marking)
101B	SDD (Added for Signing and Marking Two Lane to Four Lane Divided Transitions)
104A	SDD (Added for Signing on Roadways with Milled Surfaces)

The responsibility for notifying potential subcontractors and suppliers of these changes remains with the prime contractor.

Sincerely,

*Mike Coleman*

Proposal Development Specialist  
Proposal Management Section

**ADDENDUM NO. 02**

**7070-06-72**

**November 30, 2023**

**Special Provisions**

**4. Traffic.**

*Add the following paragraph after paragraph 4:*

Cover milled surfaces with the lower lift of HMA pavement within 72 hours of opening to traffic and prior to any holiday work restrictions.

**Schedule of Items**

Attached, dated November 30, 2023, are the revised Schedule of Items Pages 1 – 10.

**Plan Sheets**

The following 8½ x 11-inch sheets are attached and made part of the plans for this proposal:

Revised: 1, 3, 15, 16, 17, 18, 21, 22, 32.

Added: 4A, 5A, 9A, 101A, 101B, 104A.

END OF ADDENDUM

FEDERAL PROJECT	
PROJECT	
CONTRACT	
STATE PROJECT	7070-06-72

Addendum No. 02  
 ID 7070-06-72  
 Revised Sheet 1  
 November 30, 2023

ORIGINAL PLANS PREPARED BY  
**CORRE ENGINEERING**  
 1809 WARDEN STREET  
 ELK CREEK, WI 54763  
 (608)828-1011  
 www.correinc.com

**WISCONSIN REGISTERED PROFESSIONAL ENGINEER**  
 KEVIN L. MEYER  
 E-38303-006  
 ELK CREEK, WI

DATE: \_\_\_\_\_ (Professional Engineer Signature)

STATE OF WISCONSIN  
 DEPARTMENT OF TRANSPORTATION

PREPARED BY: CORRE, INC.  
 SURVEYOR: CORRE, INC.  
 DESIGNER: CORRE, INC.  
 PROJECT MANAGER: JOSHUA LANS, P.E.  
 REGIONAL CHAIRMAN: N.E. REGION  
 REGIONAL SUPERVISOR: ANDY FENCLEK, P.E.

APPROVED FOR THE DEPARTMENT  
 DATE: 11/17/23 *John J. Long* P.E. (Signature)

# STATE OF WISCONSIN DEPARTMENT OF TRANSPORTATION

## PLAN OF PROPOSED IMPROVEMENT

### AUGUSTA - CADOTT EAU CLAIRE/CHIPPEWA CO LN TO STH 29

#### CHIPPEWA COUNTY

STATE PROJECT NUMBER  
**7070-06-72**

ORDER OF SHEETS

Section No.	Title
1	Typical Sections and Details
2	Estimate of Quantities
3	Miscellaneous Quantities
4	Right of Way Plat
5	Plan and Profile
6	Standard Detail Drawings
7	Sign Plates
8	Structure Plans
9	Computer Earthwork Data
9	Cross Sections

TOTAL SHEETS =

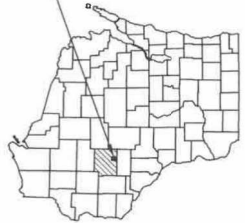

PROJECT LOCATION

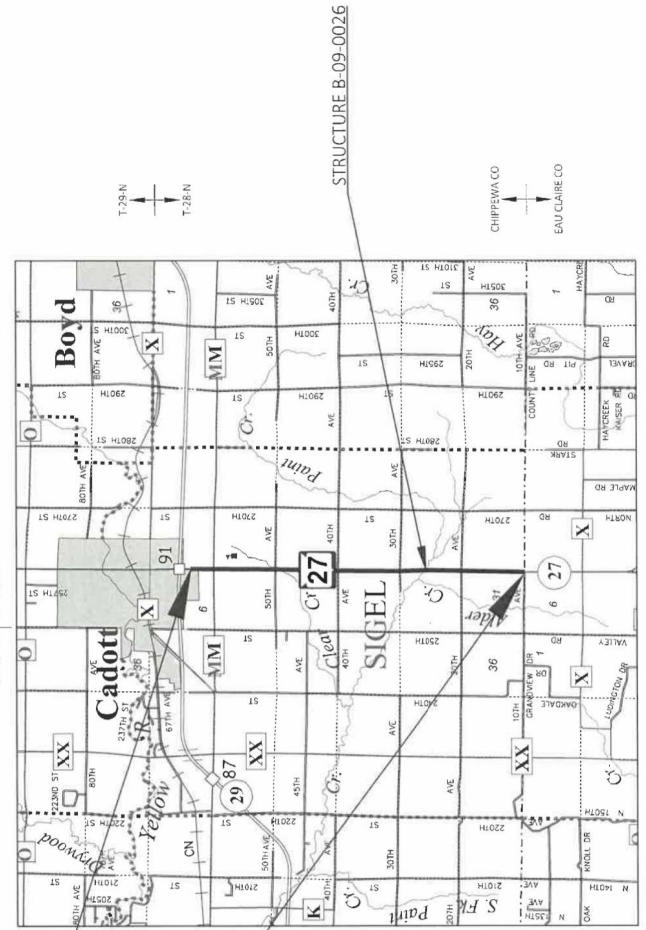

END PROJECT  
 STA 298+91

BEGIN PROJECT  
 STA 11+15  
 X: 235,558,244  
 Y: 100,660,348

DESIGN DESIGNATION

A.A.D.T. (2023)	= 1570
A.A.D.T. (2043)	= 1570
D.H.V.	= 278
D.D.	= 61/39
T.	= 24.8%
DESIGN SPEED	= 60 MPH
ESALS	= 700,000

CONVENTIONAL SYMBOLS

PLAN	ORIGINAL GROUND
CORPORATE LIMITS	MARSH OR ROCK PROFILE (To be noted as such)
PROPERTY LINE	SPECIAL DITCH
LOT LINE	GRADE ELEVATION
LIMITED HIGHWAY EASEMENT	CULVERT (Profile View)
EXISTING RIGHT OF WAY	UTILITIES
PROPOSED OR NEW R/W LINE	ELECTRIC
SCOPE INTERCEPT	FIBER OPTIC
REFERENCE LINE	GAS
EXISTING CULVERT	OVERHEAD
PROPOSED CULVERT (Box or Pipe)	SANITARY SEWER
COMBUSTIBLE FLUIDS	STORMY SEWER
	WATER
	UTILITY PRESTAL
	POWER POLE
	TELEPHONE POLE
	TELEPHONE
	W
	S
	SH
	SHRUB AREA
	WOODED OR SHRUB AREA

HORIZONTAL POSITIONS SHOWN ON THIS PLAN ARE WISCONSIN COUNTY COORDINATES SYSTEM (WCCS), CHIPPEWA COUNTY, MAD3 (2011), IN U.S. SURVEY FEET. POSITIONS SHOWN ARE GRID COORDINATES, GRID BEARINGS, AND GRID DISTANCES. GRID DISTANCES ARE THE SAME AS DISTANCES TO THE CENTERLINE. ELEVATIONS ARE TO NAVD 83 (2012). GPS DERIVED ELEVATIONS ARE BASED ON GEOID 12B.

Addendum No. 02  
ID 7070-06-72  
Revised Sheet 3  
November 30, 2023

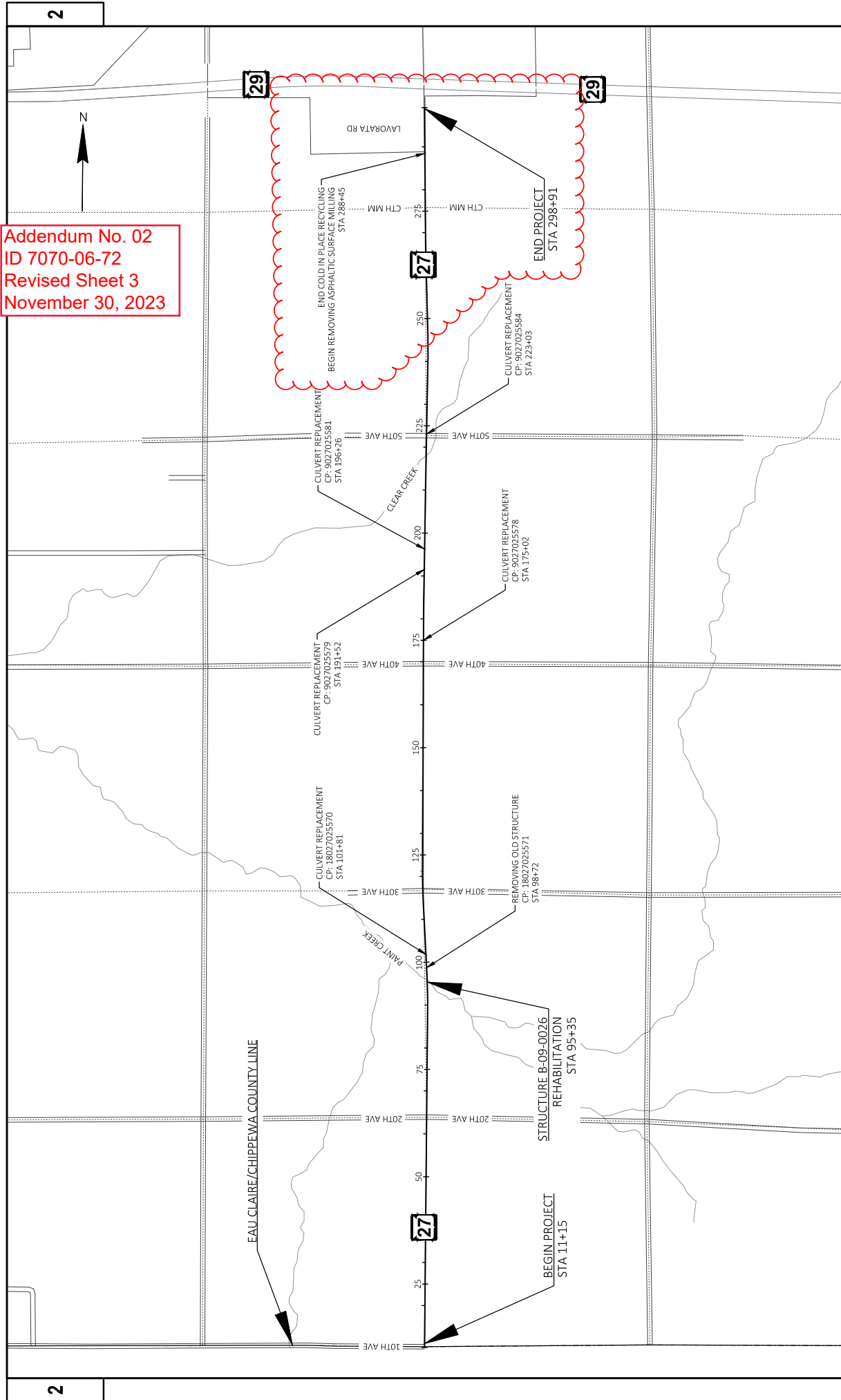

PROJECT NO: 7070-06-72	COUNTY: CHIPPEWA	PROJECT OVERVIEW	SHEET 3	E
FILE NAME: C:\ODXCORE\INC\PROJECTS - WINNW REGION\7070-06-02-CHIPPEWA CO_STH 27\590_CADD\591_L3D_2018\70700602\SHETS\591\AV02024.PLDWG	PLOT BY: CAMERON SHIFFER, PE	PLOT NAME:	PLOT SCALE: 1 IN=2000 FT	WISDOT/CADD/SHEET 42
HWY: STH 27	PLOT DATE: 11/7/2023 9:30 AM			
LAYOUT NAME: -01				

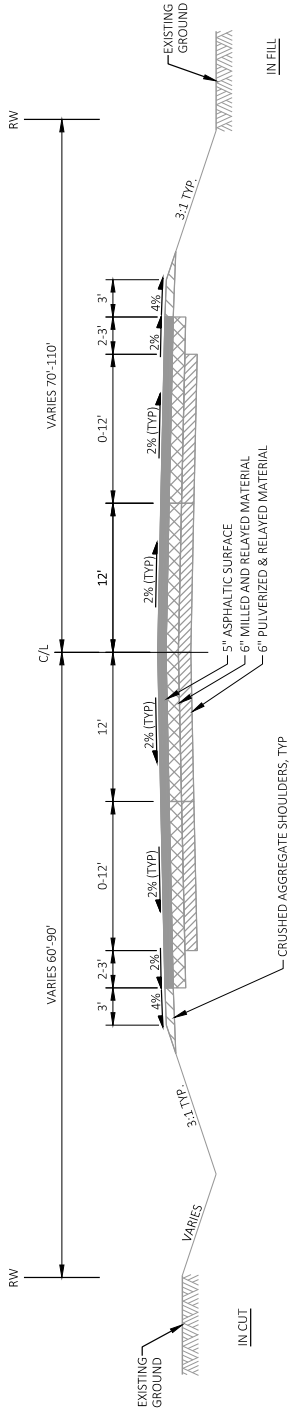

EXISTING TYPICAL SECTION - MILL

STA 288+45 TO 288+88

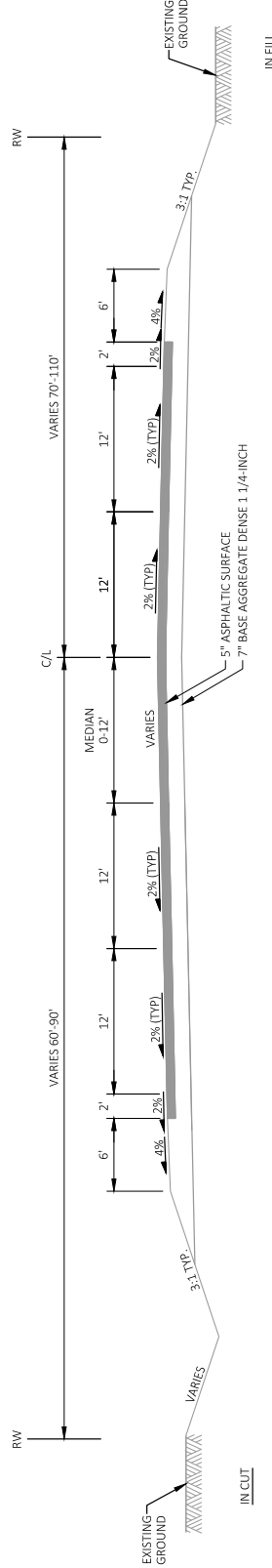

EXISTING TYPICAL SECTION - MILL

STA 286+88 TO 288+81

Addendum No. 02  
ID 7070-06-72  
Added Sheet 4A  
November 30, 2023

2

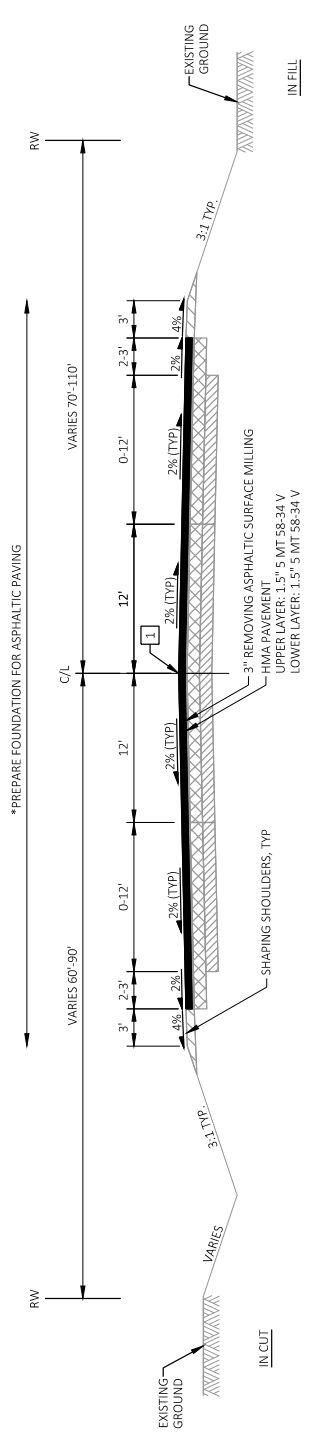

**FINISHED TYPICAL SECTION - MILL**  
STA 288+45 TO 296+88

Addendum No. 02  
ID 7070-06-72  
Added Sheet 5A  
November 30, 2023

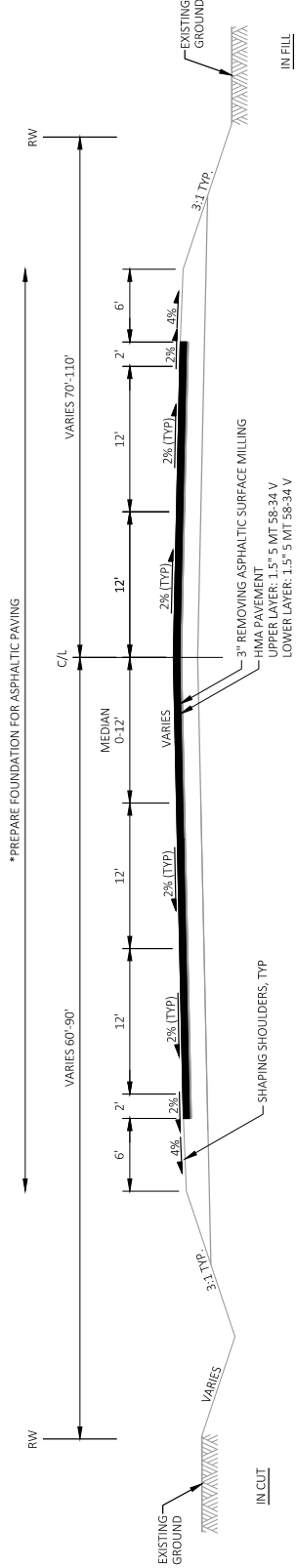

**FINISHED TYPICAL SECTION - MILL**  
STA 296+88 TO 298+91

- 1 ASPHALTIC RUMBLE STRIPS, CENTERLINE
- \* PREPARE FOUNDATION FOR ASPHALTIC PAVING BY MILLING EXISTING ASPHALT TO PROPOSED EDGE OF ASPHALT.

<b>PROJECT NO:</b> 7070-06-72	<b>HWY:</b> STH 27	<b>COUNTY:</b> CHIPPEWA	<b>TYPICAL SECTIONS</b>	<b>SHEET:</b> 5A	<b>E</b>
<p>FILE NAME: C:\VOCORRE\INC\PROJECTS - W\NW REGION\7070-06-02_CHIPPEWA.CO_STH_27\500_CADD\501_LCD_2018\70700602\Sheets\PLAN\03081-T5.DWG LAYOUT NAME: 04</p> <p>PLOT DATE: 11/7/2023 1:30 PM PLOT NAME: CAMERON SHIFFER, PE PLOT SCALE: 1 IN=30 FT</p> <p>WISDOT/CADD/SHEET 42</p>					

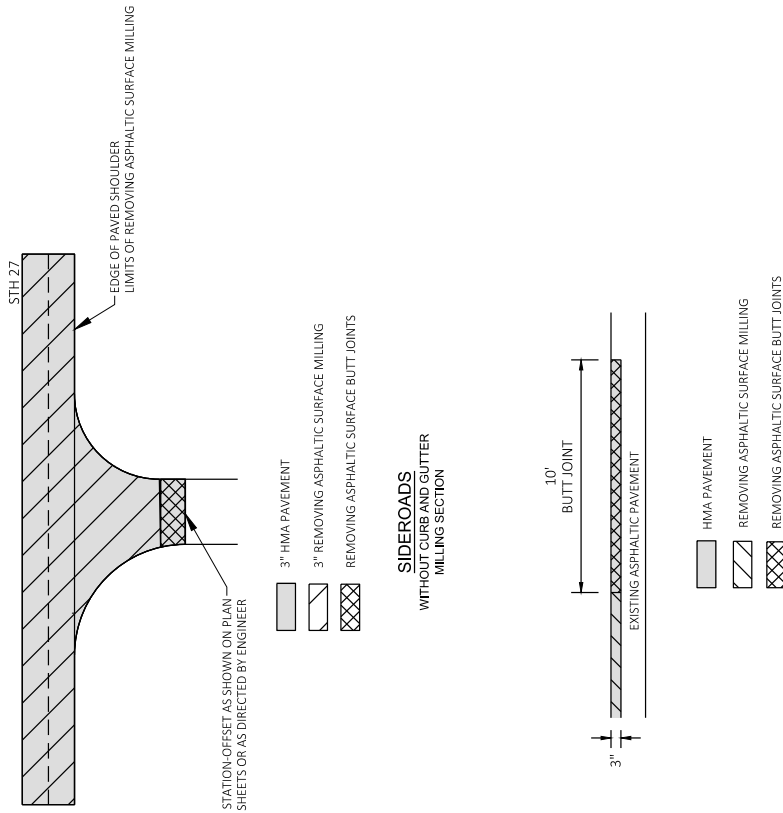

**MAINLINE AND SIDEROADS MILLING SECTION**

CORE	PAVEMENT CORE LOCATIONS AND RESULTS				BITUMINOUS THICKNESS (IN)
	NORTHING	EASTING	STATION	OFFSET	
C-01	101358.5	235557.2	17+74.2	-3.0	5.0
C-02	102303.6	235570.3	27+19.3	7.4	5.0/6.5
C-03	103275.5	235559.8	36+91.2	-6.0	7.75
C-04	104210.0	235572.5	46+25.7	4.0	4.0
C-05	105219.9	235566.7	56+35.6	-4.8	6.25
C-06	106177.1	235584.8	65+92.8	10.5	4.5
C-07	107151.3	235575.2	75+47.0	-2.0	6.5
C-08	108096.9	235590.1	85+12.6	10.2	5.25
C-09	109061.5	235570.9	94+77.4	-2.2	8.25
C-10	109950.3	235529.8	103+67.1	4.2	4.88
C-11	110932.0	235464.0	113+51.0	-7.3	5.25
C-12	111884.1	235457.3	123+03.1	7.5	4.25
C-13	112870.8	235438.3	132+89.8	-8.0	3.5
C-14	113834.9	235453.9	142+53.9	11.0	4.5
C-15	114817.2	235432.4	152+36.2	-7.0	5.5
C-16	115783.0	235442.3	162+02	6.3	5.25
C-17	116763.1	235428.2	171+82.1	-4.3	4.75
C-18	117727.7	235436.7	181+46.7	7.7	3.75
C-19	118714.4	235434.8	191+33.4	-3.5	3.38
C-20	119669.3	235451.6	200+88.5	2.2	4.5
C-21	120655.6	235458.2	210+74.8	-2.6	4.0/5.0
C-22	121606.5	235481.4	220+25.9	9.6	4.0
C-23	122574.2	235481.1	229+93.5	-1.9	4.13
C-24	123522.9	235503.8	239+42.4	9.8	3.63
C-25	124488.6	235478.0	249+08.3	-1.7	4.5
C-26	125455.5	235454.0	258+75.5	6.8	2.75
C-27	126442.3	235410.5	268+63.1	-7.9	6.25
C-28	127444.2	235414.4	278+64.8	9.5	5.75
C-29	128408.1	235384.0	288+29.0	-8.0	4.88/5.25

NORTHINGS AND EASTINGS GIVEN IN WICCS (CHIPPWA, US SURVEY FEET)  
WHERE TWO THICKNESSES ARE GIVEN, THE FIRST NUMBER IS THE THICKNESS OF THE RECOVERED CORE AND THE SECOND NUMBER IS MEASURED DOWNHOLE

GROUND PENETRATING RADAR INFORMATION AVAILABLE UPON REQUEST

Addendum No. 02  
ID 7070-06-72  
Added Sheet 9A  
November 30, 2023



Addendum No. 02  
ID 7070-06-72  
Revised Sheet 15  
November 30, 2023

204.0110  
REMOVING  
ASPHALTIC  
SURFACE

CATEGORY	STATION	TO	STATION	LOCATION	SY	REMARKS
0010	149+62	-	178+46	RT	35	PE
0010	178+46	-	199+12	LT	40	PE
0010	212+64	-	266+83	LT	30	PE
TOTAL 0010					370	

204.0115  
REMOVING  
ASPHALTIC  
SURFACE BUTT  
JOINTS

CATEGORY	STATION	TO	STATION	LOCATION	SY	REMARKS
0010	11+15	-	12+05	ML	300	STH 27
0010	63+88	-	63+90	SIDEROAD	325	20TH AVEE
0010	93+65	-	94+75	ML	475	20TH AVEE
0010	95+95	-	97+05	ML	480	STH 27
0010	116+60	-	116+67	SIDEROAD	315	30TH AVEE
0010	169+55	-	169+55	SIDEROAD	345	30TH AVEE
0010	169+56	-	169+56	SIDEROAD	330	40TH AVEE
0010	222+67	-	222+67	SIDEROAD	320	40TH AVEE
0010	222+67	-	222+67	SIDEROAD	305	50TH AVEE
0010	275+85	-	275+85	SIDEROAD	295	50TH AVEE
0010	275+88	-	275+88	SIDEROAD	460	CTH MME
0010	287+55	-	288+45	ML	570	CTH MME
0010	288+45	-	288+55	ML	300	STH 27
0010	294+14	-	294+14	ML	35	STH 27 - MILL
0010	298+81	-	298+81	ML	50	LAVERATA RD
0010	298+81	-	298+81	ML	70	STH 27
TOTAL 0010					5,305	

204.0120  
REMOVING  
ASPHALTIC  
SURFACE

CATEGORY	STATION	TO	STATION	LOCATION	SY	REMARKS
0010	288+55	-	288+81	ML	5,160	STH 27
0010	294+14	-	294+14	SIDEROAD	260	LAVERATA RD
TOTAL 0010					5,420	

201.0105 201.0205  
CLEARING GRUBBING

CATEGORY	STATION	TO	STATION	LOCATION	STA	STA
0010	96+00	-	99+00	LT	3	3
0010	159+00	-	161+00	LT	2	2
0010	195+00	-	197+00	LT	2	2
0010	258+00	-	259+00	RT	1	1
0010	279+00	-	280+00	LT & RT	1	1
TOTAL 0010					9	9

\*CLEARING TO BE COMPLETED BY OTHERS

203.0100  
REMOVING  
SMALL PIPE  
CULVERTS

CATEGORY	STATION	LOCATION	REMARKS
0010	101+81	ML	1 88 LF CPCS 36-INCH WITH LINER
0010	175+02	ML	1 63 LF CPCS 24-INCH WITH LINER
0010	191+52	ML	1 92 LF CPCS 30-INCH WITH LINER
0010	195+79	ML	1 72 LF CPCS 24-INCH WITH LINER
0010	223+03	ML	1 66 LF CPCS 30-INCH WITH LINER
TOTAL 0010			5

203.0220.01  
REMOVING  
STRUCTURE  
(STRUCTURE)  
(02. STA  
196+26)

CATEGORY	STATION	LOCATION	REMARKS
0010	98+72	ML	1 63 LF CPCS 72-INCH
0010	196+26	ML	1 63 LF CPCS 72-INCH
TOTAL 0010			1

PROJECT NO: 7070-06-72  
HWY: STH 27  
COUNTY: CHIPPEWA

MISCELLANEOUS QUANTITIES  
CAMERON SHREEVE, PE  
PLOT NAME:  
PLOT DATE: 11/14/2023 11:25 AM

SHEET 15  
E  
WISDOT/CADDS SHEET 42

DIVISION	FROM/TO STATION	LOCATION	COMMON EXCAVATION (1)		SALVAGED/UNUSABLE PAVEMENT MATERIAL (4)	AVAILABLE MATERIAL (5)	UNEPAVED FILL	EXPANDED FILL (13)		MASS ORDINATE +/- (14)	WASTE	(16) 208.0100 BORROW	COMMENT
			CUT (2)	EBS EXCAVATION (3)				FACTOR 1.25					
B-9-26 SE	93+00/94+66.192	RT	2	0	0	2	139	174	-172	0	172	(18)	
B-9-26 SW	95+00/94+66.192	LT	1	0	0	1	164	205	-204	0	204	(18)	
B-9-26 NE	96+00/98+00	RT	1	0	0	1	163	204	-203	0	203	(18)	
B-9-26 NW	96+00/98+00	LT	2	0	0	2	170	213	-211	0	211	(18)	
CP 98+72	98+72	RT & LT	555	0	41	614	0	0	614	614	0	(17)(18)	
CP 101+81	101+71/102+00	RT & LT	818	0	38	780	0	0	780	780	0	(17)(18)	
CP 175+02	174+85/179+15	RT & LT	452	0	38	414	0	0	414	414	0	(17)(18)	
CP 191+52	191+35/191+65	RT & LT	735	0	38	697	28	35	662	662	0	(17)(18)	
CP 196+26	195+60/196+50	RT & LT	751	0	57	694	72	90	604	604	0	(17)(18)	
CP 223+03	222+85/223+17.178	RT & LT	645	0	32	613	38	48	566	566	0	(17)(18)	
SINKHOLE REPAIR	VARIOUS	RT & LT	0	0	0	0	12	15	-15	0	15	(18)	
APPROACH SLAB & ASPH SURF		ML	185	0	61	124	0	0	124	124	0	(18)	
PROJECT SUBTOTAL			4,247	0	305	3,942	786	984	2,959	3,764	805		
GRAND TOTAL		TOTAL COMMON EXC	4,247	0	305	3,942	786	984	2,959	3,764	805		

Addendum No. 02  
ID 7070-06-72  
Revised Sheet 16  
November 30, 2023

NOTES:  
(1) COMMON EXCAVATION IS THE SUM OF THE CUT AND EBS EXCAVATION COLUMNS. ITEM NUMBER 205.0100  
(2) SALVAGED/UNUSABLE PAVEMENT MATERIAL IS INCLUDED IN CUT  
(4) SALVAGED/UNUSABLE PAVEMENT MATERIAL  
(5) AVAILABLE MATERIAL = CUT - SALVAGED/UNUSABLE PAVEMENT MATERIAL  
EXPANDED FILL = (UNEPAVED FILL) \* FILL FACTOR  
(14) THE MASS ORDINATE +/- OR -QTY CALCULATED FOR THE DIVISION. PLUS QUANTITY INDICATES AN EXCESS OF MATERIAL WITHIN THE DIVISION. MINUS INDICATES A SHORTAGE OF MATERIAL WITHIN THE DIVISION.  
(15) FACTORS USED TO COMPUTE ANTICIPATED WASTE AND THE COMPUTED WASTE VOLUME IDENTIFIED ARE FOR GENERAL INFORMATION ONLY.  
(17) SEE CONSTRUCTION DETAIL IN PLAN SET FOR CULVERT PIPE TRANSITION. EACH CULVERT IS AN ISOLATED LOCATION  
(18) ALL SECTIONS ARE QUANTIFIED AS INDIVIDUAL DIVISIONS.

CATEGORY	STATION	LOCATION	REMARKS	TEMPORARY LANE SHIFT DURING CULVERT WORK		BASE AGGREGATE DENSE 1.174	
				EACH	BORROW	INCH	TONS
0010	98+72	ML	CULVERT PIPE REMOVAL	1	19	20	
0010	101+81	ML	CULVERT PIPE REPLACEMENT	1	34	30	
0010	175+02	ML	CULVERT PIPE REPLACEMENT	1	2	30	
0010	191+52	ML	CULVERT PIPE REPLACEMENT	1	69	65	
0010	196+26	ML	CULVERT PIPE REPLACEMENT	1	80	15	
TOTAL 0010				5			

\*QUANTITIES SHOWN ARE FOR INFORMATION ONLY AND ARE CONSIDERED INCIDENTAL TO LANE SHIFT

Addendum No. 02  
ID 7070-06-72  
Revised Sheet 17  
November 30, 2023

305.0120  
BASE  
AGGREGATE  
DENSE 1 1/4-  
INCH

CATEGORY	STATION	TO	STATION	LOCATION	TON	REMARKS
0010	93+10	-	97+43	ML	35	B-9-26 TEMP WIDENING
0010	98+16	-	99+28	ML	335	CULVERT PIPE
0010	101+29	-	102+33	ML	310	CULVERT PIPE
0010	174+50	-	175+54	ML	310	CULVERT PIPE
0010	191+00	-	192+04	ML	310	CULVERT PIPE
0010	195+27	-	196+82	ML	460	CULVERT PIPE
0010	222+88	-	223+55	ML	250	CULVERT PIPE
TOTAL 0010					2,010	

CATEGORY	STATION	TO	STATION	LOCATION	STA	REMARKS
0010	11+15	-	288+45	ML	556	CIR OPERATIONS
0010	288+45	-	298+91	ML	22	MILLING SECTION
TOTAL 0010					578	

305.0500  
SHAPING  
SHOULDERS

327.1000.S  
CIR ASPHALTIC  
BASE LAYER  
AGENT

CATEGORY	STATION	TO	STATION	LOCATION	SY	TON
0010	11+15	-	94+75	ML	27,900	95
0010	95+95	-	288+45	ML	64,200	220
TOTAL 0010					92,100	315

415.0070  
CONCRETE  
PAVEMENT  
7-INCH  
APPROACH SLAB

CATEGORY	STATION	TO	STATION	LOCATION	SY	TON
0010	94+75	-	94+94	ML	20	52
0010	95+75	-	95+95	ML	20	52
TOTAL 0010					40	104

211.0400  
PREPARE  
FOUNDATION  
FOR ASPHALTIC  
SHOULDERS

CATEGORY	STATION	TO	STATION	LOCATION	STA	REMARKS
0010	93+00	-	98+00	LT & RT	10	TEMP WIDENING
TOTAL 0010					10	

211.0700.S.01  
PREPARE  
FOUNDATION FOR  
CIR BASE LAYER

CATEGORY	STATION	TO	STATION	LOCATION	EA	CY	REMARKS
0010	11+15	-	288+45	PROJECT	1	1,000	BASE REPAIR FOR CIR LAYER
TOTAL 0010					1	1,000	

305.0110  
BASE  
AGGREGATE  
DENSE 3/4-INCH

CATEGORY	STATION	TO	STATION	LOCATION	TON	REMARKS
0010	11+15	-	63+90	ML	900	BOP TO 20TH AVE
0010	63+90	-	95+01	ML	610	20TH AVE TO BRIDGE
0010	95+69	-	116+67	ML	440	BRIDGE TO 30TH AVE
0010	116+67	-	169+35	ML	930	30TH AVE TO 40TH AVE
0010	169+55	-	222+68	ML	940	40TH AVE TO 50TH AVE
0010	222+68	-	275+88	ML	980	50TH AVE TO CTH MM
0010	275+88	-	288+45	ML	220	CTH MM TO EOP
TOTAL 0010					5,020	

PROJECT NO: 7070-06-72 HWY: STH 27 COUNTY: CHIPPEWA

FILE NAME: C:\DVCORR\INC\PROJECTS - WWW REGION\7070-06-02-CHIPPEVA.CO\_STH\_27\500\_CADD\501\_L3D\_2018\70700602\2\70700602\01-MS.DWG

FLY BY: CAMERON SHIFFER, PE PLOT NAME: CAMERON SHIFFER, PE

FLY DATE: 11/14/2023 11:25 AM

PLOT SCALE: 1"=1'

WISDOT/CADD SHEET 42

Addendum No. 02  
ID 7070-06-72  
Revised Sheet 18  
November 30, 2023

460.0105.5  
HMA PERCENT  
WITHIN LIMITS  
(PWU) TEST  
STRIP  
VOLUMETRICS  
EACH

CATEGORY	LOCATION	PROJECT	TON
0010	PROJECT	1	
	TOTAL 0010	1	

465.0110  
ASPHALTIC  
SURFACE  
PATCHING

CATEGORY	STATION	TO	STATION	LOCATION	TON	REMARKS
0010	11+15	-	288+45	UNDISTRIBUTED	25	POTHOLES, MISC. REPAIRS
			TOTAL 0010		25	

455.0605  
460.6645  
465.0105  
HMA PAVEMENT  
SURFACE  
5 MT 58-34 V

CATEGORY	STATION	TO	STATION	LOCATION	GAL	TON	TON	REMARKS
0010	98+16	-	99+28	ML	20	-	85	CULVERT PIPE
0010	101+29	-	102+33	ML	20	-	80	CULVERT PIPE
0010	174+50	-	175+54	ML	20	-	80	CULVERT PIPE
0010	191+00	-	192+04	ML	20	-	80	CULVERT PIPE
0010	195+27	-	196+82	ML	30	-	120	CULVERT PIPE
0010	222+88	-	223+55	ML	20	-	75	CULVERT PIPE
0010	93+10	-	97+43	ML	20	-	120	B-9-26 STAGING
0010	11+15	-	94+75	ML	3,390	4,340	-	BDP TO BRIDGE
0010	63+88	-		RT	35	50	-	20TH AVEE
0010	63+90	-		LT	35	50	-	20TH AVEE
0010	95+95	-	288+45	ML	7,850	10,100	-	BRIDGE TO END CIF
0010	116+60	-		RT	35	50	-	30TH AVEE
0010	116+67	-		LT	40	50	-	30TH AVEE
0010	169+55	-		LT	35	50	-	40TH AVEE
0010	169+56	-		RT	35	50	-	40TH AVEE
0010	222+67	-		LT	35	40	-	50TH AVEE
0010	222+68	-		RT	30	40	-	50TH AVEE
0010	275+85	-		RT	45	60	-	CTHMMW
0010	275+88	-		LT	50	70	-	CTHMMW
0010	288+45	-	298+91	ML	635	890	-	END CIR TO EOP
0010	294+14	-		LT	40	60	-	LAVORATA RD
	TOTAL 0010				12,440	15,900	640	

LOCATION	STATION	MIXTURE USE	PWL MIXTURE USE TABLE			THICKNESS	MATERIAL	QUALITY MANAGEMENT PROGRAM TO BE USED FOR DENSITY ACCEPTANCE	REMARKS
			UNDERLYING SURFACE	BID ITEM	TONS				
DRIVING LANES	11+15 TO 288+45	UPPER LAYER	5 MT 58-34 V	5 MT 58-34 V	5885	1.5-INCHES	5885	INCENTIVE DENSITY PWL HMA PAVEMENT SPV.0055.01	RT 4 2-INCH PE
DRIVING LANES	11+15 TO 288+45	LOWER LAYER	CIR	5 MT 58-34 V	4555	1.25-INCHES	4555	INCENTIVE DENSITY PWL HMA PAVEMENT SPV.0055.01	LT 4 2-INCH PE
PAVED SHOULDERS	11+15 TO 288+45	UPPER LAYER	5 MT 58-34 V	5 MT 58-34 V	1540	1.5-INCHES	1540	INCENTIVE AIR VOIDS HMA PAVEMENT SPV.0055.02	RT 5 2-INCH PE
PAVED SHOULDERS	11+15 TO 288+45	LOWER LAYER	CIR	5 MT 58-34 V	1260	1.25-INCHES	1260	ACCEPTANCE TESTING BY CORE SPECIAL PROVISION, NOT ELIGIBLE FOR INCENTIVE.	RT 21 2-INCH PE
SIDE ROADS	VARIOUS	UPPER LAYER	5 MT 58-34 V	5 MT 58-34 V	280	1.5-INCHES	280	ACCEPTANCE TESTING BY CORE SPECIAL PROVISION, NOT ELIGIBLE FOR INCENTIVE.	LT 4 2-INCH PE
SIDE ROADS	VARIOUS	LOWER LAYER	CIR	5 MT 58-34 V	230	1.25-INCHES	230	INCENTIVE DENSITY PWL HMA PAVEMENT SPV.0055.01	TOTAL 0010 38
DRIVING LANES	TEST STRIP	UPPER LAYER	5 MT 58-34 V	5 MT 58-34 V	600	1.5-INCHES	600	INCENTIVE AIR VOIDS HMA PAVEMENT SPV.0055.02	
DRIVING LANES	TEST STRIP	LOWER LAYER	CIR	5 MT 58-34 V	600	1.25-INCHES	600	INCENTIVE AIR VOIDS HMA PAVEMENT SPV.0055.01	
PAVED SHOULDERS	TEST STRIP	UPPER LAYER	5 MT 58-34 V	5 MT 58-34 V	150	1.5-INCHES	150	ACCEPTANCE TESTING BY CORE SPECIAL PROVISION, NOT ELIGIBLE FOR INCENTIVE.	
PAVED SHOULDERS	TEST STRIP	LOWER LAYER	CIR	5 MT 58-34 V	150	1.25-INCHES	150	ACCEPTANCE TESTING BY CORE SPECIAL PROVISION, NOT ELIGIBLE FOR INCENTIVE.	
DRIVING LANES	288+45 TO 298+91	UPPER LAYER	5 MT 58-34 V	5 MT 58-34 V	235	1.5-INCHES	235	INCENTIVE DENSITY PWL HMA PAVEMENT SPV.0055.01	
DRIVING LANES	288+45 TO 298+91	LOWER LAYER	MILLED SURFACE	5 MT 58-34 V	235	1.5-INCHES	235	INCENTIVE AIR VOIDS HMA PAVEMENT SPV.0055.02	
PAVED SHOULDERS & APPURTENANCES	288+45 TO 298+91	UPPER LAYER	5 MT 58-34 V	5 MT 58-34 V	240	1.5-INCHES	240	ACCEPTANCE TESTING BY CORE SPECIAL PROVISION, NOT ELIGIBLE FOR INCENTIVE.	
PAVED SHOULDERS & APPURTENANCES	288+45 TO 298+91	LOWER LAYER	MILLED SURFACE	5 MT 58-34 V	240	1.5-INCHES	240	ACCEPTANCE TESTING BY CORE SPECIAL PROVISION, NOT ELIGIBLE FOR INCENTIVE.	
CULVERT PATCHES	VARIOUS	UPPER LAYER	ASPHALTIC SURFACE	ASPHALTIC SURFACE	260	2-INCHES	260	ACCEPTANCE BY ORDINARY COMPACTION	
CULVERT PATCHES	VARIOUS	LOWER LAYER	BASE AGGREGATE	ASPHALTIC SURFACE	260	2-INCHES	260	OMP AS PER SS-465	
B-09-0026 WIDENING	93+10 TO 97+43	UPPER LAYER	ASPHALTIC SURFACE	ASPHALTIC SURFACE	60	2-INCHES	60		
B-09-0026 WIDENING	93+10 TO 97+43	LOWER LAYER	BASE AGGREGATE	ASPHALTIC SURFACE	60	2-INCHES	60		

CATEGORY	STATION	TO	STATION	LOCATION	TON
0010	11+15	-	289+75	CL	25,700
	TOTAL 0010				25,700

**Addendum No. 02**  
**ID 7070-06-72**  
**Revised Sheet 21**  
**November 30, 2023**

CATEGORY	LOCATION	643.0300		643.0420		643.0705		643.0715		643.0900		643.1000		643.5000		651.0101.01		REMARKS	
		DAYS	DEVICES	DAYS	DEVICES	DAYS	DEVICES	DAYS	DEVICES	DAYS	DEVICES	DAYS	DEVICES	DAYS	DEVICES	DAYS	DEVICES		
0010	PROJECT	-	-	-	-	-	-	-	-	-	-	-	-	-	-	-	-	-	ADVANCED WARNING
0010	PROJECT	10	24	240	-	-	-	-	-	-	-	-	-	-	-	-	-	-	CULVERTS
0010	B-9-26	20	41	820	20	1	20	2	40	-	-	-	-	-	-	-	-	-	STAGE 1
0010	B-9-26	20	41	820	20	1	20	2	40	20	25	500	-	-	-	-	-	-	STAGE 2
0010	PROJECT	5	40	200	-	-	-	-	-	20	25	500	-	-	-	-	-	-	MILL & OVERLAY
TOTAL 0010		2,080		40		80		1,000		3,625		64		1		1			
TOTAL 0010		33,080		18,720		240		74,401		40		750							

CATEGORY	STATION	TO	STATION	LOCATION	643.3165		643.3170		643.3180		643.3805		646.2040		646.7120		646.9000		REMARKS
					MARKING LINE PAINT 6-INCH	MARKING LINE EPOXY 6-INCH	TEMPORARY MARKING LINE REMOVABLE TAPE 6-INCH	TEMPORARY MARKING LINE STOP LINE PAINT 18-INCH	MARKING LINE GROOVED WET REF EPOXY 6-INCH	MARKING DIAGONAL EPOXY REMOVAL LINE 4-INCH	MARKING DIAGONAL EPOXY REMOVAL LINE 4-INCH	MARKING DIAGONAL EPOXY REMOVAL LINE 4-INCH	MARKING DIAGONAL EPOXY REMOVAL LINE 4-INCH						
0010	91+50	-	99+00	ML	3,800	-	-	-	-	-	-	-	-	-	-	-	-	-	STAGE 1 B-09-0026
0010	91+50	-	99+00	ML	760	-	240	-	-	-	-	-	-	-	-	-	-	-	STAGE 2 B-09-0026
0010	11+15	-	288+45	CL	12,050	-	-	-	-	-	-	-	-	-	-	-	-	-	CIR LAYER YELLOW CENTERLINE
0010	11+15	-	288+45	CL	12,050	-	-	-	-	-	-	-	-	-	-	-	-	-	LOWER LIFT YELLOW CENTERLINE
0010	11+15	-	288+45	CL	-	-	16,550	-	-	-	-	-	-	-	-	-	-	-	UPPER LIFT YELLOW CENTERLINE BEFORE RUMBLE
0010	11+15	-	288+45	RT	-	-	-	-	-	-	26,750	-	-	-	-	-	-	-	UPPER LIFT WHITE EDGE LINE
0010	11+15	-	288+45	RT	-	-	-	-	-	-	26,750	-	-	-	-	-	-	-	UPPER LIFT WHITE EDGE LINE
0010	11+15	-	288+45	CL	-	-	-	-	-	-	16,550	-	-	-	-	-	-	-	UPPER LIFT YELLOW CENTERLINE AFTER RUMBLE
0010	288+45	-	298+91	CL	2,130	-	-	-	-	-	-	-	-	-	-	-	-	-	MILLED LAYER YELLOW CENTERLINE
0010	293+54	-	298+91	RT	44	-	-	-	-	-	-	-	-	-	-	-	-	-	MILLED LAYER LANE LANE
0010	294+81	-	298+91	LT	36	-	-	-	-	-	-	-	-	-	-	-	-	-	MILLED LAYER LANE LANE
0010	288+45	-	298+91	CL	-	-	2,170	-	-	-	-	-	-	-	-	-	-	-	LOWER LIFT LANE LINE
0010	288+45	-	298+91	CL	-	-	-	-	-	-	2,170	-	-	-	-	-	-	-	UPPER LIFT YELLOW CENTERLINE BEFORE RUMBLE
0010	288+45	-	298+91	RT	-	-	-	-	-	-	880	-	-	-	-	-	-	-	UPPER LIFT YELLOW CENTERLINE AFTER RUMBLE
0010	288+45	-	298+91	LT	-	-	-	-	-	-	1,050	-	-	-	-	-	-	-	UPPER LIFT WHITE EDGE LINE
0010	293+54	-	298+91	RT	-	-	-	-	-	-	138	-	-	-	-	-	-	-	UPPER LIFT WHITE EDGE LINE
0010	294+81	-	298+91	LT	-	-	-	-	-	-	113	-	-	-	-	-	-	-	UPPER LIFT WHITE LANE LINE
0010	297+21	-	298+91	CL	-	-	-	-	-	-	40	-	-	-	-	-	-	-	UPPER LIFT WHITE LANE LINE
TOTAL 0010		33,080		18,720		240		74,401		40		750							



Addendum No. 02  
 ID 7070-06-72  
 Revised Sheet 32  
 November 30, 2023

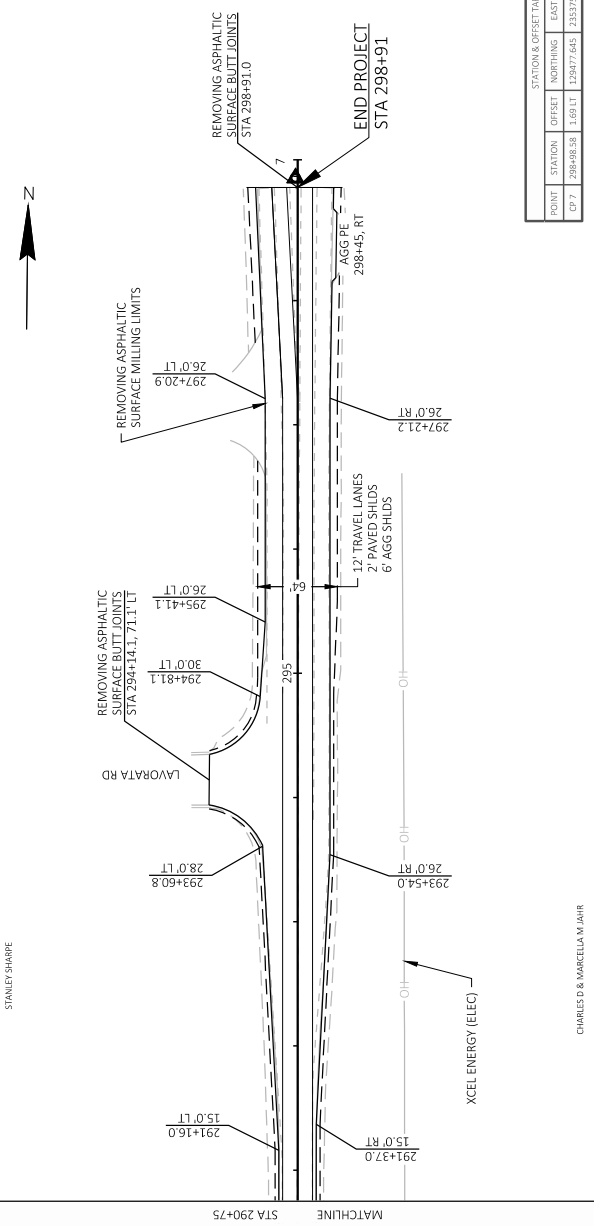
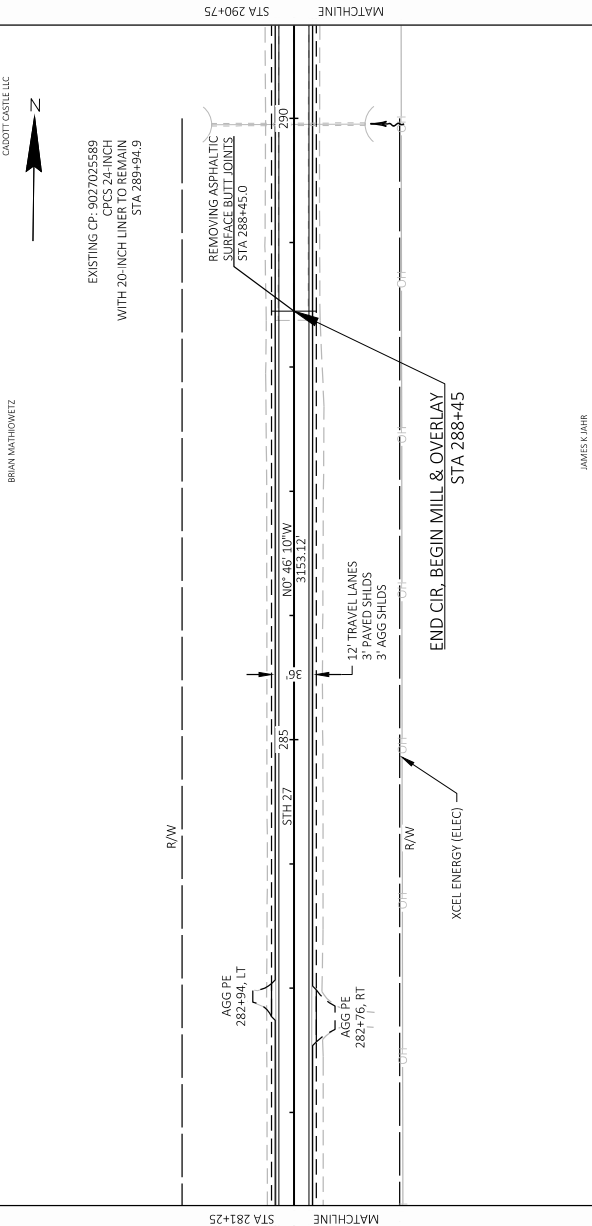

BRIAN WATHOWETZ



EXISTING CP: 907025589  
 CPCS 24-INCH  
 WITH 20-INCH LINER TO REMAIN  
 STA 289+94.9

JAMES KUJARR



STATION & OFFSET TABLE						
POINT	STATION	OFFSET	NORTHING	EASTING	ELEVATION	DESCRIPTION
CP 7	288+68.58	1.00 FT	25877.645	26372.891	1091.04	WAGC MILE

FILE NAME: C:\D:\GIBBS\INC\PROJECTS\WYOM REGION\7070-06-72\ADD\ADD\01\_23\11292023\11292023\PLAN\MODELS\PLAN\WAGC\7070-06-72-32.DWG PLOT DATE: 11/29/2023 11:29 AM PLOT NAME: CAMERON\_SHEEPER\_NE PLOT SCALE: 1"=100.00'

CHARLES D & MARCELLA M JAHR

6

4

Addendum No. 02  
ID 7070-06-72  
Added Sheet 101A  
November 30, 2023

**MEDIAN ISLAND  
PAVEMENT MARKINGS**

STATE OF WISCONSIN  
DEPARTMENT OF TRANSPORTATION

APPROVED \_\_\_\_\_  
DATE \_\_\_\_\_  
BY \_\_\_\_\_  
STATE SIGNING ENGINEER  
J.S. Jaramila Silver  
BOUNSBEL

101A

**GENERAL NOTES**

① DIAGONALS ARE OPTIONAL WHEN PAINTED ISLAND IS LESS THAN 5 FEET AT THE WIDEST POINT. OMIT DIAGONALS IF WIDTH IS LESS THAN 3 FEET.



\* CONFIRM MARKING LINE WIDTH WITH THE MISCELLANEOUS QUANTITIES

SPEED LIMIT	L
<35 MPH	5'
35 > MPH	50'

\*\* WHEN THE PAINTED MEDIAN LENGTH IS LESS THAN 50 FEET THE SPACING IS 10'.  
\*\*

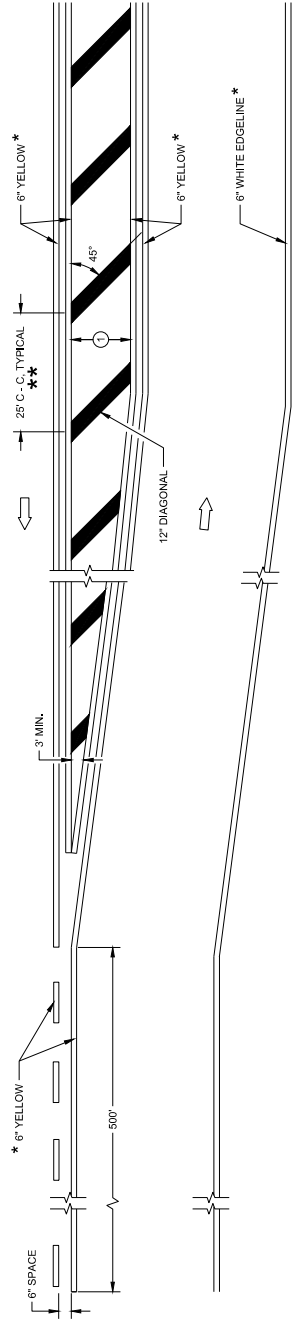

**MEDIAN ISLAND DETAIL**

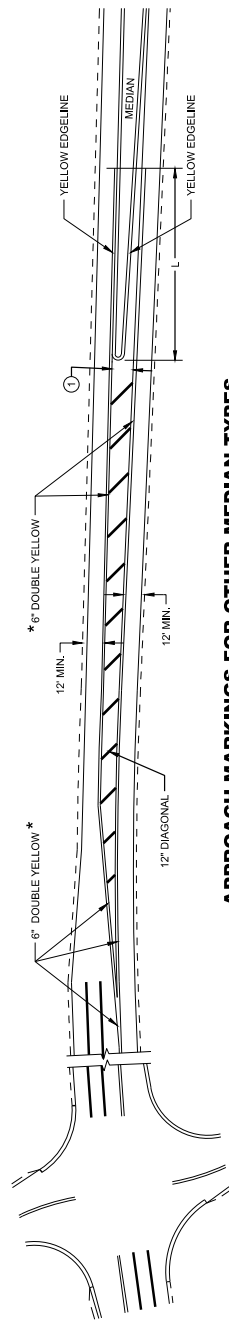

**APPROACH MARKINGS FOR OTHER MEDIAN TYPES**

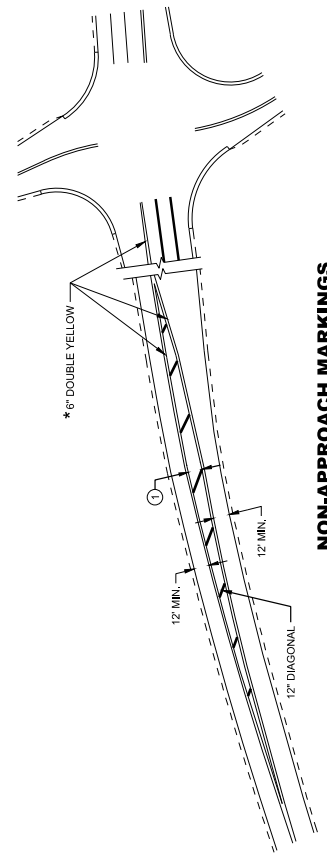

**NON-APPROACH MARKINGS**



**GENERAL NOTES**

- SIGNING AND MARKING IS SHOWN AS TYPICAL PLACEMENT. FIELD CONDITIONS MAY DICTATE CHANGES IN SIGNING AND MARKING PLACEMENT.
- ① USED ONLY WHEN APPROVED BY REGION TRAFFIC ENGINEER.
- \* CONFIRM MARKING LINE WIDTH WITH THE MISCELLANEOUS QUANTITIES
- \*\* SIGNS MAY BE OMITTED IF SPACE DOES NOT PERMIT PLACEMENT.
- \*\*\* IF POSTED SPEED IS 45 MPH OR GREATER, PLACE W5-54 SIGN UNDER R4-7 SIGN. MOUNT W5-54 SIGN AT 4' MOUNTING HEIGHT (TOP OF ROADWAY TO BOTTOM OF SIGN).

**LEGEND**

- A DISTANCE DEPENDENT ON SPEED (SEE TABLE)
- ⊥ SIGN MOUNTED ON PERMANENT SUPPORT
- ⇨ DIRECTION OF TRAFFIC

**DISTANCE TABLE**

POSTED OR 85TH PERCENTILE SPEED	DISTANCE "A"
25	325'
30	460'
35	565'
40	670'
45	775'
50	885'
55	990'
65	1200'
70	1250'

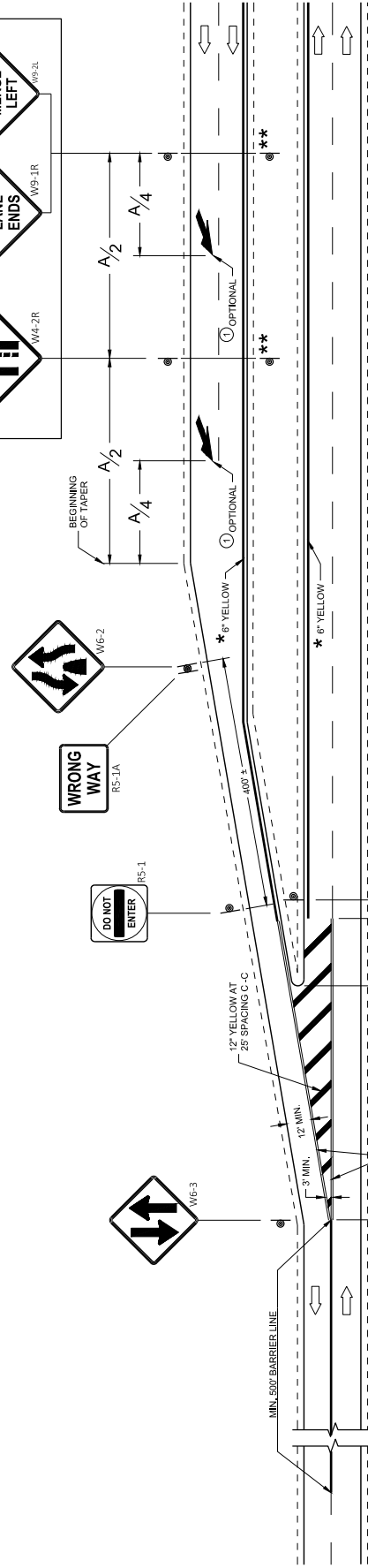
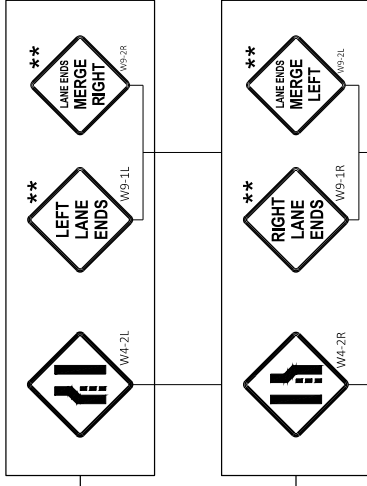

Addendum No. 02  
 ID 7070-06-72  
 Added Sheet 101B  
 November 30, 2023

**SIGNING AND MARKING  
 TWO LANE TO FOUR LANE  
 DIVIDED TRANSITIONS**

STATE OF WISCONSIN  
 DEPARTMENT OF TRANSPORTATION

APPROVED \_\_\_\_\_  
 DATE MAY 2023  
 FOR Matthew Raabach  
 STATE SIGNING AND MARKING  
 ENGINEER

101B

# SDD 15D44 Traffic Control, Signing on Roadways With Milled Surfaces

## GENERAL NOTES

- DRAWING NOT TO SCALE. ALL SIGNS AND POSTS ON THIS SHEET SHALL BE PAID FOR WITH "TRAFFIC CONTROL SIGNS" BID ITEM. ALL SIDE ROADS WHICH ARE UNDER CONSTRUCTION OF CURB AND GUTTER AND/OR GRADING SHALL BE ADEQUATELY SIGNED.
- ALL SIGNS AND DEVICES SHALL BE IN CONFORMANCE WITH THE WISCONSIN MANUAL OF UNIFORM TRAFFIC CONTROL DEVICES (WMUTCD). SIGN LAYOUTS SHALL BE IN ACCORDANCE WITH THE MSDOT STANDARD SIGN PLATES.
- "W" SIGNS ARE THE SAME AS "W" SIGNS EXCEPT THAT THE BACKGROUND IS ORANGE.
- ALL SIGNS ARE 48" X 48" UNLESS OTHERWISE NOTED.
- THE EXACT NUMBER, LOCATION AND SPACING OF ALL SIGNS AND DEVICES SHALL BE ADJUSTED TO FIT FIELD CONDITIONS AS DIRECTED BY THE ENGINEER.
- ALL SIGNS INAPPROPRIATE TO THE STATUS OF THE CONTROL ZONE, INCLUDING PRE-EXISTING SIGNS IN THE VICINITY, SHALL BE COVERED OR REMOVED AS DIRECTED BY THE ENGINEER.
- SEE 15C04 FOR ADDITIONAL TRAFFIC CONTROL SIGNING WHEN CENTERLINE PAVEMENT MARKINGS ARE MISSING. DO NOT PASS SIGNS MUST BE INSTALLED ON THE SAME DAY AS MILLING OPERATIONS.

- ① PLACE SIGNS 350' IN ADVANCE OF MILLED SURFACES AND AT 1 MILE INTERVALS, OR AS DIRECTED BY THE ENGINEER.
- ② PLACE SIGN 200' MIN. FROM INTERSECTION AND 200' MIN. AFTER ADVANCE WARNING SIGN SHOWN IN SDD 15C04.

## LEGEND

⊥ SIGN ON TEMPORARY SUPPORT

⇨ DIRECTION OF TRAFFIC

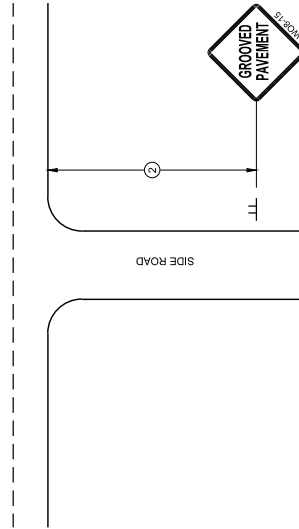

TYPICAL SIDE ROAD APPROACH SIGN DETAIL

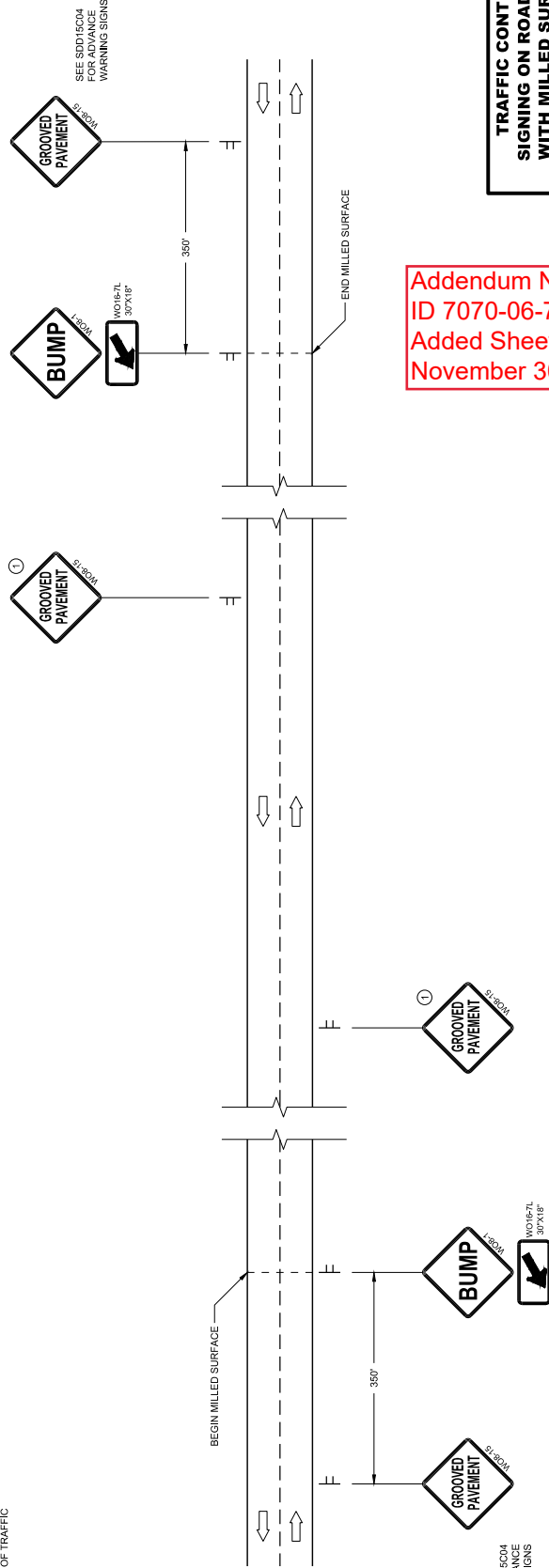

Addendum No. 02  
ID 7070-06-72  
Added Sheet 104A  
November 30, 2023

DETAIL FOR SIGNING ON MILLED SURFACES

104A

TRAFFIC CONTROL,  
SIGNING ON ROADWAYS  
WITH MILLED SURFACES

STATE OF WISCONSIN  
DEPARTMENT OF TRANSPORTATION

APPROVED  
FEBRUARY 2021  
DATE  
/S/ Andrew Hedberg  
WORK ZONE ENGINEER



Proposal Schedule of Items

Proposal ID: 20231212033 Project(s): 7070-06-72

Federal ID(s): N/A

SECTION: 0001 Contract Items

Alt Set ID: Alt Mbr ID:

Proposal Line Number	Item ID Description	Approximate Quantity and Units	Unit Price	Bid Amount
0002	201.0205 Grubbing	9.000 STA	_____.	_____.
0004	203.0100 Removing Small Pipe Culverts	5.000 EACH	_____.	_____.
0006	203.0211.S Abatement of Asbestos Containing Material (structure) 01. B-9-26	1.000 EACH	_____.	_____.
0008	203.0220 Removing Structure (structure) 01. Sta 98+72	1.000 EACH	_____.	_____.
0010	203.0220 Removing Structure (structure) 02. Sta 196+26	1.000 EACH	_____.	_____.
0012	204.0110 Removing Asphaltic Surface	370.000 SY	_____.	_____.
0014	204.0115 Removing Asphaltic Surface Butt Joints	5,305.000 SY	_____.	_____.
0016	204.0165 Removing Guardrail	378.000 LF	_____.	_____.
0018	205.0100 Excavation Common	4,247.000 CY	_____.	_____.
0020	208.0100 Borrow	805.000 CY	_____.	_____.
0022	208.1500.S Temporary Lane Shift During Culvert Work	5.000 EACH	_____.	_____.
0024	209.0200.S Backfill Controlled Low Strength	50.000 CY	_____.	_____.
0026	210.1500 Backfill Structure Type A	30.000 TON	_____.	_____.
0028	211.0400 Prepare Foundation for Asphaltic Shoulders	10.000 STA	_____.	_____.
0030	211.0700.S Prepare Foundation for CIR Base Layer (project) 01. 7070-06-72	1.000 EACH	_____.	_____.



Proposal Schedule of Items

Proposal ID: 20231212033 Project(s): 7070-06-72

Federal ID(s): N/A

SECTION: 0001 Contract Items

Alt Set ID: Alt Mbr ID:

Proposal Line Number	Item ID Description	Approximate Quantity and Units	Unit Price	Bid Amount
0032	211.0800.S Base Repair for CIR Layer	1,000.000 CY	_____.	_____.
0034	213.0100 Finishing Roadway (project) 01. 7070-06-72	1.000 EACH	_____.	_____.
0036	305.0110 Base Aggregate Dense 3/4-Inch	5,020.000 TON	_____.	_____.
0038	305.0120 Base Aggregate Dense 1 1/4-Inch	2,010.000 TON	_____.	_____.
0040	327.1000.S CIR Asphaltic Base Layer	92,100.000 SY	_____.	_____.
0042	415.0070 Concrete Pavement 7-Inch	40.000 SY	_____.	_____.
0044	415.0410 Concrete Pavement Approach Slab	104.000 SY	_____.	_____.
0046	455.0605 Tack Coat	12,440.000 GAL	_____.	_____.
0048	455.0770.S Asphalt Stabilizing Agent	315.000 TON	_____.	_____.
0050	460.0105.S HMA Percent Within Limits (PWL) Test Strip Volumetrics	1.000 EACH	_____.	_____.
0052	460.6645 HMA Pavement 5 MT 58-34 V	15,900.000 TON	_____.	_____.
0054	465.0105 Asphaltic Surface	640.000 TON	_____.	_____.
0056	465.0110 Asphaltic Surface Patching	25.000 TON	_____.	_____.
0058	465.0120 Asphaltic Surface Driveways and Field Entrances	38.000 TON	_____.	_____.
0060	465.0560 Asphaltic Rumble Strips, Centerline	25,700.000 LF	_____.	_____.



Proposal Schedule of Items

Proposal ID: 20231212033 Project(s): 7070-06-72

Federal ID(s): N/A

SECTION: 0001 Contract Items

Alt Set ID: Alt Mbr ID:

Proposal Line Number	Item ID Description	Approximate Quantity and Units	Unit Price	Bid Amount
0062	502.3200 Protective Surface Treatment	350.000 SY	_____.	_____.
0064	502.3205 Pigmented Surface Sealer Reseal	70.000 SY	_____.	_____.
0066	509.0301 Preparation Decks Type 1	150.000 SY	_____.	_____.
0068	509.0302 Preparation Decks Type 2	60.000 SY	_____.	_____.
0070	509.0505.S Cleaning Decks to Reapply Concrete Masonry Overlay	350.000 SY	_____.	_____.
0072	509.1500 Concrete Surface Repair	370.000 SF	_____.	_____.
0074	509.2000 Full-Depth Deck Repair	15.000 SY	_____.	_____.
0076	509.2500 Concrete Masonry Overlay Decks	32.000 CY	_____.	_____.
0078	509.9005.S Removing Concrete Masonry Deck Overlay (structure) 01. B-9-26	350.000 SY	_____.	_____.
0080	509.9010.S Removing Asphaltic Concrete Deck Overlay (structure) 01. B-9-26	350.000 SY	_____.	_____.
0082	520.1024 Apron Endwalls for Culvert Pipe 24-Inch	2.000 EACH	_____.	_____.
0084	520.1030 Apron Endwalls for Culvert Pipe 30-Inch	2.000 EACH	_____.	_____.
0086	520.3424 Culvert Pipe Class III-A Non-metal 24-Inch	72.000 LF	_____.	_____.
0088	520.3430 Culvert Pipe Class III-A Non-metal 30-Inch	84.000 LF	_____.	_____.
0090	520.8700 Cleaning Culvert Pipes	5.000 EACH	_____.	_____.



Proposal Schedule of Items

Proposal ID: 20231212033 Project(s): 7070-06-72

Federal ID(s): N/A

SECTION: 0001 Contract Items

Alt Set ID: Alt Mbr ID:

Proposal Line Number	Item ID Description	Approximate Quantity and Units	Unit Price	Bid Amount
0092	522.0424 Culvert Pipe Reinforced Concrete Class IV 24-Inch	54.000 LF	_____.	_____.
0094	522.0430 Culvert Pipe Reinforced Concrete Class IV 30-Inch	80.000 LF	_____.	_____.
0096	522.0448 Culvert Pipe Reinforced Concrete Class IV 48-Inch	64.000 LF	_____.	_____.
0098	522.1024 Apron Endwalls for Culvert Pipe Reinforced Concrete 24-Inch	2.000 EACH	_____.	_____.
0100	522.1030 Apron Endwalls for Culvert Pipe Reinforced Concrete 30-Inch	2.000 EACH	_____.	_____.
0102	522.1048 Apron Endwalls for Culvert Pipe Reinforced Concrete 48-Inch	2.000 EACH	_____.	_____.
0104	601.0588 Concrete Curb & Gutter 4-Inch Sloped 36-Inch Type TBT	100.000 LF	_____.	_____.
0106	601.0590 Concrete Curb & Gutter 4-Inch Sloped 36-Inch Type TBTT	101.000 LF	_____.	_____.
0108	602.3010 Concrete Surface Drains	8.000 CY	_____.	_____.
0110	603.8000 Concrete Barrier Temporary Precast Delivered	475.000 LF	_____.	_____.
0112	603.8125 Concrete Barrier Temporary Precast Installed	950.000 LF	_____.	_____.
0114	606.0200 Riprap Medium	154.000 CY	_____.	_____.
0116	614.0905 Crash Cushions Temporary	4.000 EACH	_____.	_____.
0118	614.2300 MGS Guardrail 3	87.500 LF	_____.	_____.



Proposal Schedule of Items

Proposal ID: 20231212033 Project(s): 7070-06-72

Federal ID(s): N/A

SECTION: 0001 Contract Items

Alt Set ID: Alt Mbr ID:

Proposal Line Number	Item ID Description	Approximate Quantity and Units	Unit Price	Bid Amount
0120	614.2500 MGS Thrie Beam Transition	160.000 LF	_____.	_____.
0122	614.2610 MGS Guardrail Terminal EAT	4.000 EACH	_____.	_____.
0124	618.0100 Maintenance and Repair of Haul Roads (project) 01. 7070-06-72	1.000 EACH	_____.	_____.
0126	619.1000 Mobilization	1.000 EACH	_____.	_____.
0128	624.0100 Water	50.000 MGAL	_____.	_____.
0130	625.0500 Salvaged Topsoil	7,990.000 SY	_____.	_____.
0132	627.0200 Mulching	2,250.000 SY	_____.	_____.
0134	628.1504 Silt Fence	2,550.000 LF	_____.	_____.
0136	628.1520 Silt Fence Maintenance	2,550.000 LF	_____.	_____.
0138	628.1905 Mobilizations Erosion Control	2.000 EACH	_____.	_____.
0140	628.1910 Mobilizations Emergency Erosion Control	1.000 EACH	_____.	_____.
0142	628.2004 Erosion Mat Class I Type B	5,740.000 SY	_____.	_____.
0144	628.7504 Temporary Ditch Checks	120.000 LF	_____.	_____.
0146	628.7555 Culvert Pipe Checks	139.000 EACH	_____.	_____.
0148	629.0210 Fertilizer Type B	6.000 CWT	_____.	_____.
0150	630.0120 Seeding Mixture No. 20	228.000 LB	_____.	_____.



Proposal Schedule of Items

Proposal ID: 20231212033 Project(s): 7070-06-72

Federal ID(s): N/A

SECTION: 0001 Contract Items

Alt Set ID: Alt Mbr ID:

Proposal Line Number	Item ID Description	Approximate Quantity and Units	Unit Price	Bid Amount
0152	630.0500 Seed Water	189.000 MGAL	_____.	_____.
0154	633.5200 Markers Culvert End	10.000 EACH	_____.	_____.
0156	638.2102 Moving Signs Type II	6.000 EACH	_____.	_____.
0158	638.4000 Moving Small Sign Supports	6.000 EACH	_____.	_____.
0160	642.5001 Field Office Type B	1.000 EACH	_____.	_____.
0162	643.0300 Traffic Control Drums	2,080.000 DAY	_____.	_____.
0164	643.0420 Traffic Control Barricades Type III	40.000 DAY	_____.	_____.
0166	643.0705 Traffic Control Warning Lights Type A	80.000 DAY	_____.	_____.
0168	643.0715 Traffic Control Warning Lights Type C	1,000.000 DAY	_____.	_____.
0170	643.0900 Traffic Control Signs	3,625.000 DAY	_____.	_____.
0172	643.1000 Traffic Control Signs Fixed Message	64.000 SF	_____.	_____.
0174	643.3165 Temporary Marking Line Paint 6-Inch	33,080.000 LF	_____.	_____.
0176	643.3170 Temporary Marking Line Epoxy 6-Inch	18,720.000 LF	_____.	_____.
0178	643.3180 Temporary Marking Line Removable Tape 6-Inch	240.000 LF	_____.	_____.
0180	643.3805 Temporary Marking Stop Line Paint 18-Inch	24.000 LF	_____.	_____.
0182	643.5000 Traffic Control	1.000 EACH	_____.	_____.





Proposal Schedule of Items

Proposal ID: 20231212033 Project(s): 7070-06-72

Federal ID(s): N/A

SECTION: 0001 Contract Items

Alt Set ID: Alt Mbr ID:

Proposal Line Number	Item ID Description	Approximate Quantity and Units	Unit Price	Bid Amount
0184	645.0120 Geotextile Type HR	521.000 SY	_____.	_____.
0186	646.2040 Marking Line Grooved Wet Ref Epoxy 6-Inch	74,401.000 LF	_____.	_____.
0188	646.9000 Marking Removal Line 4-Inch	750.000 LF	_____.	_____.
0190	648.0100 Locating No-Passing Zones	5.450 MI	_____.	_____.
0192	650.5500 Construction Staking Curb Gutter and Curb & Gutter	201.000 LF	_____.	_____.
0194	650.6000 Construction Staking Pipe Culverts	5.000 EACH	_____.	_____.
0196	650.8000 Construction Staking Resurfacing Reference	28,776.000 LF	_____.	_____.
0198	650.9911 Construction Staking Supplemental Control (project) 01. 7070-06-72	1.000 EACH	_____.	_____.
0200	650.9920 Construction Staking Slope Stakes	366.000 LF	_____.	_____.
0202	661.0101 Temporary Traffic Signals for Bridges (structure) 01. B-09-26	1.000 EACH	_____.	_____.
0204	690.0150 Sawing Asphalt	675.000 LF	_____.	_____.
0206	715.0720 Incentive Compressive Strength Concrete Pavement	500.000 DOL	1.00000	500.00
0208	740.0440 Incentive IRI Ride	21,750.000 DOL	1.00000	21,750.00
0210	SPV.0035 Special 01. Partially Grouted Riprap	30.000 CY	_____.	_____.



Proposal Schedule of Items

Proposal ID: 20231212033 Project(s): 7070-06-72

Federal ID(s): N/A

SECTION: 0001 Contract Items

Alt Set ID: Alt Mbr ID:

Proposal Line Number	Item ID Description	Approximate Quantity and Units	Unit Price	Bid Amount
0212	SPV.0055 Special 01. Incentive Density PWL HMA Pavement	11,810.000 DOL	1.00000	11,810.00
0214	SPV.0055 Special 02. Incentive Air Voids HMA Pavement	15,900.000 DOL	1.00000	15,900.00
0216	SPV.0055 Special 03. Incentive Density HMA Pavement Longitudinal Joints	11,470.000 DOL	1.00000	11,470.00
0218	SPV.0090 Special 01. Ditch Cleaning	1,590.000 LF	_____.	_____.
0220	204.0120 Removing Asphaltic Surface Milling	5,420.000 SY	_____.	_____.
0222	211.0101 Prepare Foundation for Asphaltic Paving (project) 01. 7070-06-72	1.000 EACH	_____.	_____.
0224	305.0500 Shaping Shoulders	578.000 STA	_____.	_____.
0226	646.7120 Marking Diagonal Epoxy 12-Inch	40.000 LF	_____.	_____.
<b>Section: 0001</b>			<b>Total:</b>	_____.
			<b>Total Bid:</b>	_____.



## Wisconsin Department of Transportation

---

December 4, 2023

**Division of Transportation Systems  
Development**

Bureau of Project Development  
4822 Madison Yards Way, 4<sup>th</sup> Floor South  
Madison, WI 53705

Telephone: (608) 266-1631  
Facsimile (FAX): (608) 266-8459

### NOTICE TO ALL CONTRACTORS:

**Proposal #33: 7070-06-72**  
**Augusta – Cadott**  
**Eau Claire/Chippewa Co Ln to STH 29**  
**STH 27**  
**Chippewa County**

### Letting of December 12, 2023

This is Addendum No. 03, which provides for the following:

#### Special Provisions:

Deleted Special Provisions	
Article No.	Description
28	Notice to Contractor, Electronic Load Tickets

The responsibility for notifying potential subcontractors and suppliers of these changes remains with the prime contractor.

Sincerely,

*Mike Coleman*

Proposal Development Specialist  
Proposal Management Section

**ADDENDUM NO. 03**  
**7070-06-721**  
**December 4, 2023**

**Special Provisions**

**28. DELETED**

END OF ADDENDUM